



Partner technologiczny w dziedzinie ekonomicznej obróbki skrawaniem

OBRÓBKA OTWORÓW



Rozwiązania narzędziowe i procesowe w połączeniu z kompleksowymi usługami

Postrzegamy siebie jako partnera technologicznego, który wspiera Państwa w rozwoju wydajnych i oszczędnych procesów produkcyjnych, z wykorzystaniem narzędzi standardowych, indywidualnych koncepcji narzędziowych oraz narzędzi zoptymalizowanych. Jednocześnie nasze narzędzia spełniają wymagania dotyczące niezawodności procesu, precyzji i prostoty obsługi. W jaki sposób jest to możliwe? Dzięki nieustannemu rozwojowi w zakresie produkcji i konstrukcji narzędzi, a także produkcji z wykorzystaniem najnowocześniejszego parku maszynowego.

Poszukują Państwo nie tylko optymalnego narzędzia do realizacji określonego zadania obróbczego, ale również partnera, który jest w stanie przejąć całe planowanie i wsparcie procesu? Także w tym przypadku pozostajemy do Państwa dyspozycji, oferując wsparcie we wszystkich fazach procesu produkcyjnego, utrzymując proces produkcyjny na najwyższym poziomie: wydajny, ekonomiczny i stabilny. Ponadto oferujemy Państwu kompletne rozwiązania dla wszystkich zadań peryferijnych towarzyszących procesowi obróbki.

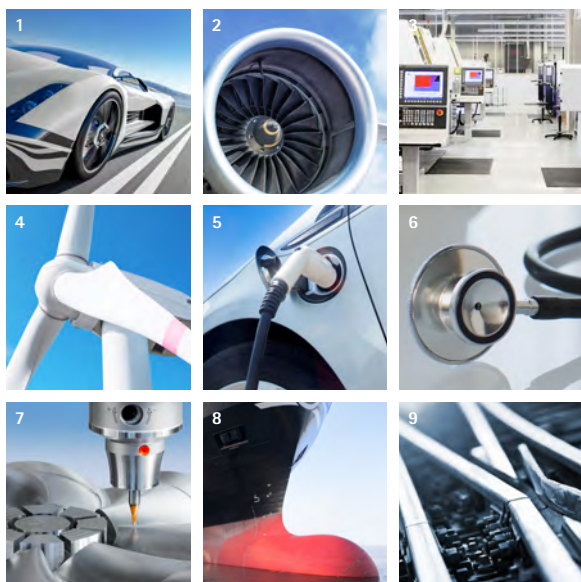

Branże

- 1 Motoryzacja
- 2 Lotnictwo i technologie kosmiczne
- 3 Budowa maszyn
- 4 Wytwarzanie energii
- 5 Elektromobilność
- 6 Technologie medyczne
- 7 Produkcja narzędzi i form
- 8 Przemysł stoczniowy
- 9 Komunikacja szynowa

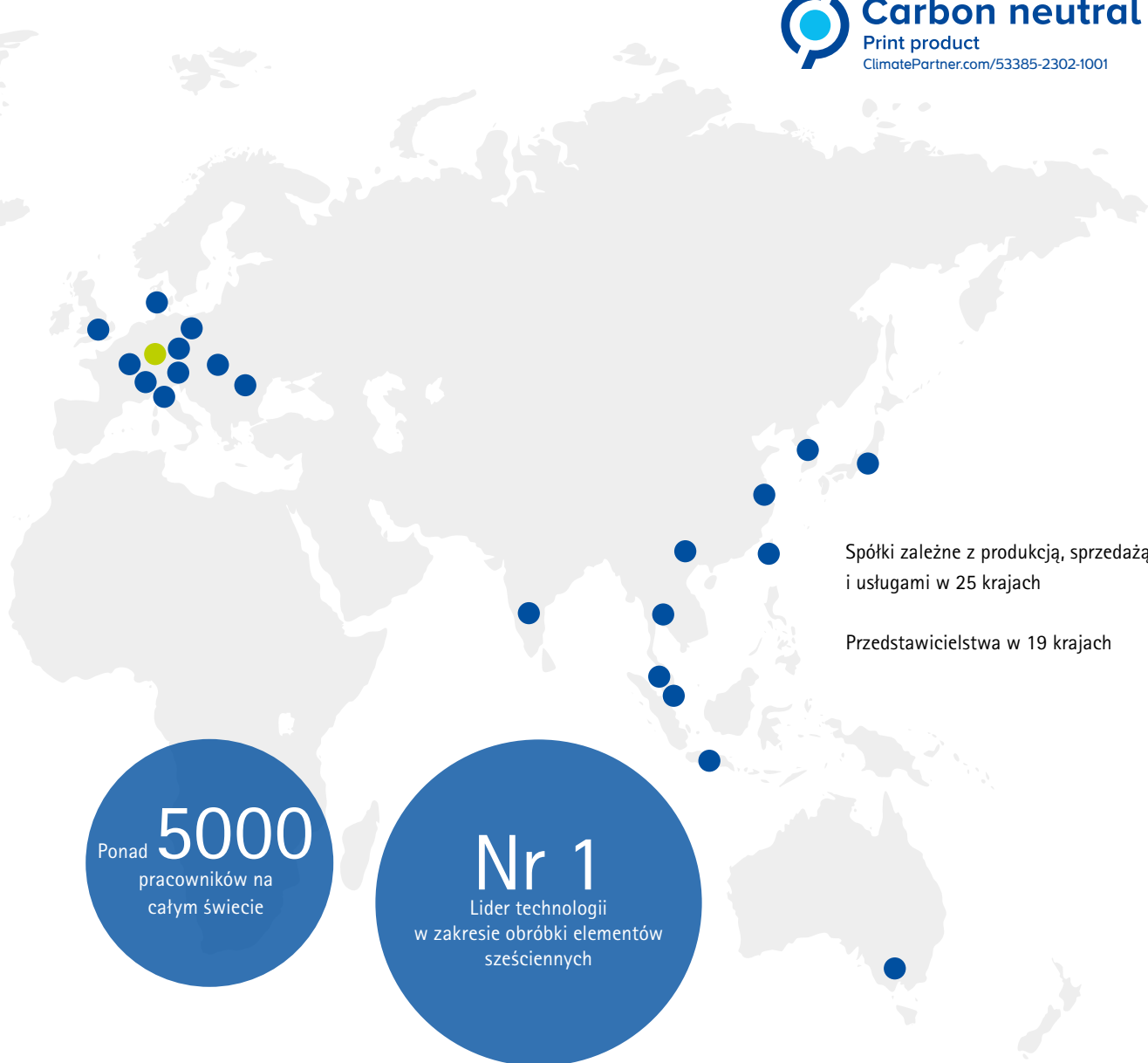

Ponad **5000**
pracowników na
całym świecie

Nr 1
Lider technologii
w zakresie obróbki elementów
sześciennych



Zakres oferty

- 1 Rozwiercanie i rozwiercanie precyzyjne
- 2 Wiercenie w pełnym materiale, nawiercanie i pogłębianie
- 3 Frezowanie
- 4 Toczenie
- 5 Narzędzia mechatroniczne
- 6 Technika mocowania
- 7 Ustawianie, pomiary i wydawanie narzędzi
- 8 Usługi



SPIS TREŚCI

01 Wstęp

Kompetencja w zakresie obróbki otworów	6
Przegląd programu	8

02 Wiercenie w pełnym materiale

Przegląd produktów, przegląd typoszeregu, pomoc w doborze narzędzia, oznaczenia ..	12
Wiercenie w pełnym materiale	
Wiercenie w pełnym materiale wiertłem z węgliku spiekanego	29
Wiercenie w pełnym materiale systemem z wymienną głowicą	183
Wiercenie w pełnym materiale narzędziami z płytkami skrawającymi ..	239
Nawieranie	245
Wiercenie otworu stopniowanego	257
Wiercenie głębokich otworów	267
Wiercenie i rozwiercanie w jednym kroku roboczym	289
Rozwiązania specjalne	300

03 Rozwiercanie i rozwiercanie precyzyjne

Przegląd produktów	306
Stałe rozwiertaki wielostrzowe	311
Narzędzia z listwami prowadzącymi	477
Rozwiązania do otworów o dużych średnicach	560
Rozwiązania specjalne	572

04 Pogłębianie

Pogłębiacze stożkowe	585
----------------------------	-----

05 Nawiercanie i toczenie

Przegląd produktów	596
Rozwiązania specjalne	598
ModulBore	613
Oprawki narzędziowe	643
Płytki skrawające	663

06 Aneks techniczny

Aneks techniczny	737
------------------------	-----

KOMPETENCJA W ZAKRESIE OBRÓBKI OTWORÓW

Optymalne narzędzie do każdego zastosowania

Punktem wyjścia do opracowania przez firmę MAPAL kompleksowego programu standardowego narzędzi do obróbki otworów było skoncentrowanie się na produkcji narzędzi specjalnych do indywidualnych rozwiązań obróbczych różnych klientów.

MAPAL jest jednym z największych światowych dostawców narzędzi z węglika spiekaneego. Oferta wiertel obejmuje rozwiązania do stabilnej i ekonomicznej obróbki niemal każdego materiału obrabianego, a jej dopełnieniem są nowoczesne systemy z wymienną głowicą, które pozwalają osiągnąć maksymalną opłacalność procesu.

W skład programu narzędzi do obróbki precyzyjnej otworów wchodzi stałe rozwiertaki wieloostrowe, jak również narzędzia z listwami prowadzącymi, rozwiertaki jednoostrowe, system EasyAdjust (EA) oraz precyzyjnie szlifowane płytki skrawające i rozwiązania do otworów o dużych średnicach do 400 mm.

Narzędzia z płytkami skrawającymi odgrywają wiodącą rolę w dziedzinie nawiercania. Szczególnie ekonomiczne są płytki skrawające promieniowe ustawione pod kątem dodatnim, przeznaczone do nawiercania i toczenia. Odpowiedzią na najbardziej zaawansowane wymagania w obszarze nawiercania są płytki skrawające styczne.



Wiercenie w pełnym materiale



MAPAL oferuje kompleksowy program standardowy wiertel z węglika spiekaneego do wszystkich zadań obróbczych. Oprócz narzędzi dwu- i trójostrowych do wiercenia w pełnym materiale, asortyment produktów obejmuje również nawiertaki, wiertła stopniowane, wiertła do głębokiego wiercenia i wiertło-rozwiertaki do wiercenia i rozwiercania w jednym kroku roboczym. Ponadto dostępne są wiertła z systemem z wymienną głowicą i z płytkami skrawającymi.

MAPAL oferuje odpowiednie wiertło niezależnie od rodzaju obrabianego materiału – mogą to być żeliwa, metale nieżelazne, stале, nowoczesne materiały lekkie czy materiały trudnoobrabialne.

Rozwiercanie i rozwiercanie precyzyjne



Rozwiercanie i rozwiercanie precyzyjne są najczęściej stosowanymi metodami obróbki wykończeniowej otworów i przekonują najbardziej dokładnymi rezultatami. W zależności od złożoności obróbki oraz wymagań dotyczących precyzji i powierzchni MAPAL oferuje odpowiednie rozwiązanie. Stałe rozwiertaki wieloostrowe pozwalają na uzyskanie dużych wartości posuwu i znacznie skracają czas obróbki. W skład oferty wchodzi rozwiertaki monolityczne z węglika spiekaneego, cermetu lub HSS, jak również rozwiertaki z wymienną głowicą HPR z wysoce precyzyjnym złączem HFS. Do obróbki otworów o dużych średnicach do 400 mm dostępny jest modułowy program HPR.

Najwyższą precyzję obróbki zapewniają narzędzia z listwami prowadzącymi. Oprócz rozwiertaków jednoostrowych w skład programu standardowego wchodzi m.in. system EasyAdjust do łatwego ustawiania narzędzi w najkrótszym czasie oraz precyzyjnie szlifowane płytki skrawające.

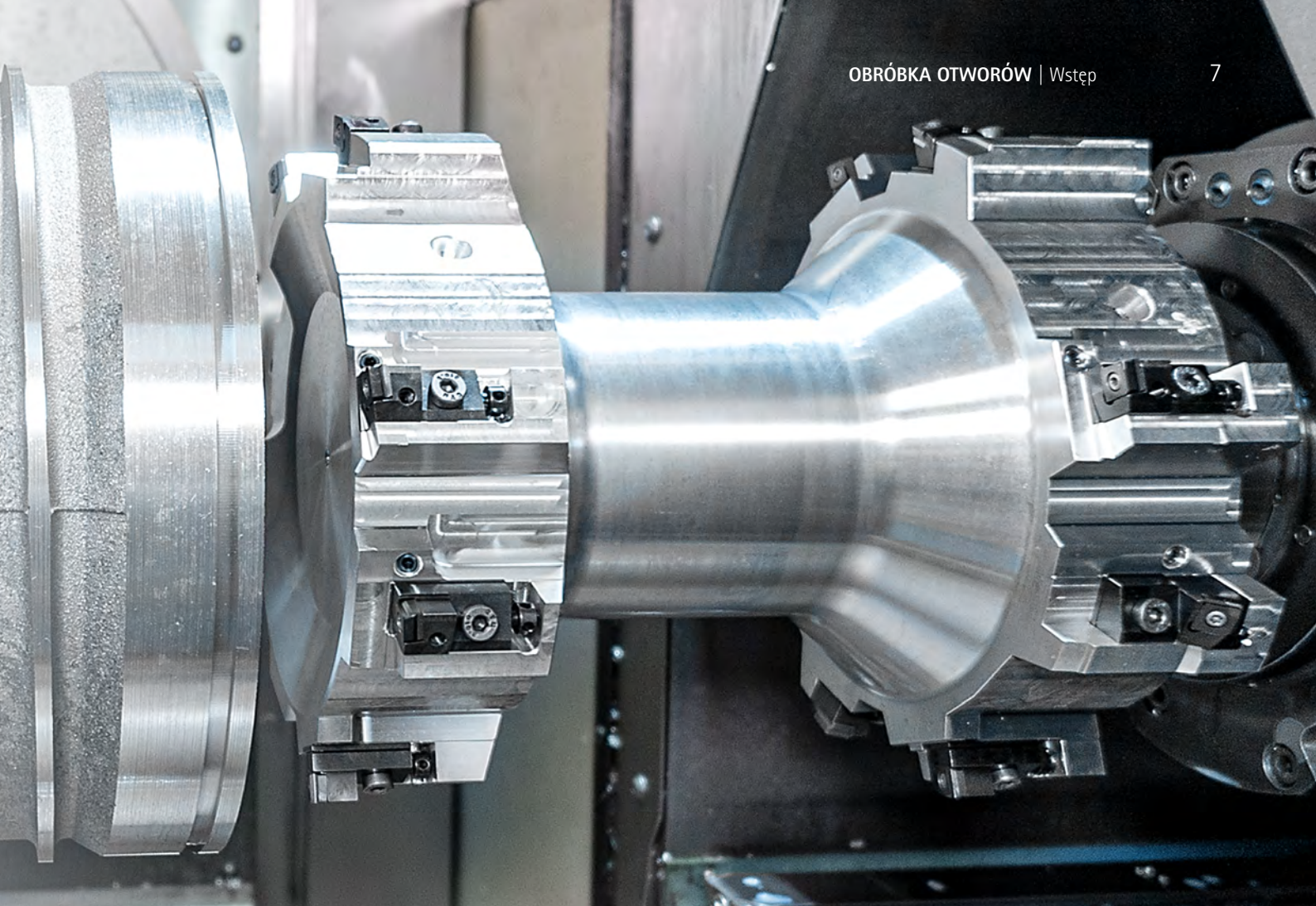

Pogłębianie

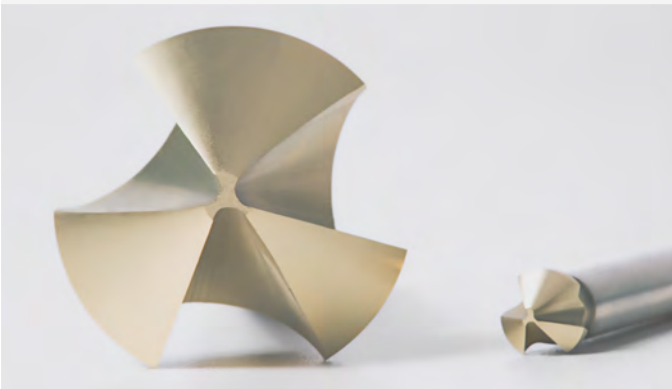

Dzięki pogłębiaczom stożkowym o ekstremalnie nierównomiernej podziałce firma MAPAL ustanowiła nowy standard w dziedzinie pogłębiania. Pogłębiacze stożkowe dostępne są w wersji z HSS i węgla spiekanego i pracują ze znacznie zredukowanymi siłami osiowymi i promieniowymi w porównaniu z tradycyjnymi pogłębiaczami. Wynikające z tego korzyści to poprawa jakości powierzchni, długa wytrzymałość narzędzi oraz uzyskanie optymalnych połączeń śrubowych i nitowych.

Powiercanie i toczenie



MAPAL oferuje różne koncepcje i rozwiązania narzędziowe do nawiercania i toczenia. Są one zoptymalizowane pod kątem różnych wymagań, oferują elastyczność, ekonomiczność i stabilność procesu nawet w przypadku wymagających operacji obróbkowych. Portfolio produktów obejmuje m.in. oprawki narzędziowe, płytki skrawające promieniowe i styczne, indywidualne rozwiązania z ostrzami PCD lub płytkami skrawającymi PCD oraz program ModulBore do nawiercania, dostosowany do konkretnych wymagań klienta.

PRZEGLĄD PROGRAMU



1 | Wiercenie w pełnym materiale

- 1.1 Wiercenie w pełnym materiale wiertłem z węglika spiekane (od strony 29)
- 1.2 Wiercenie w pełnym materiale systemem z wymienną głowicą (od strony 183)
Wiercenie w pełnym materiale narzędziami z płytkami skrawającymi (od strony 239)
- 1.3 Nawiercanie (od strony 245)
- 1.4 Wiercenie otworu stopniowanego (od strony 257)
- 1.5 Wiercenie głębokich otworów (od strony 267)
- 1.6 Wiercenie i rozwiercanie w jednym kroku roboczym (od strony 289)

2 | Rozwiercanie i rozwiercanie precyzyjne

- 2.1 Rozwiertak wysoko wydajny | FXR (od strony 316)
- 2.2 Rozwiertak z wymienną głowicą | HPR (od strony 368)
Rozwiertaki wysoko wydajne z końcówkami | MOR/MRF (od strony 350)
- 2.3 Rozwiertak jednoostrzowy (od strony 478)
- 2.4 System EasyAdjust (od strony 514)
- 2.5 Rozwiązania do otworów o dużych średnicach (od strony 560)

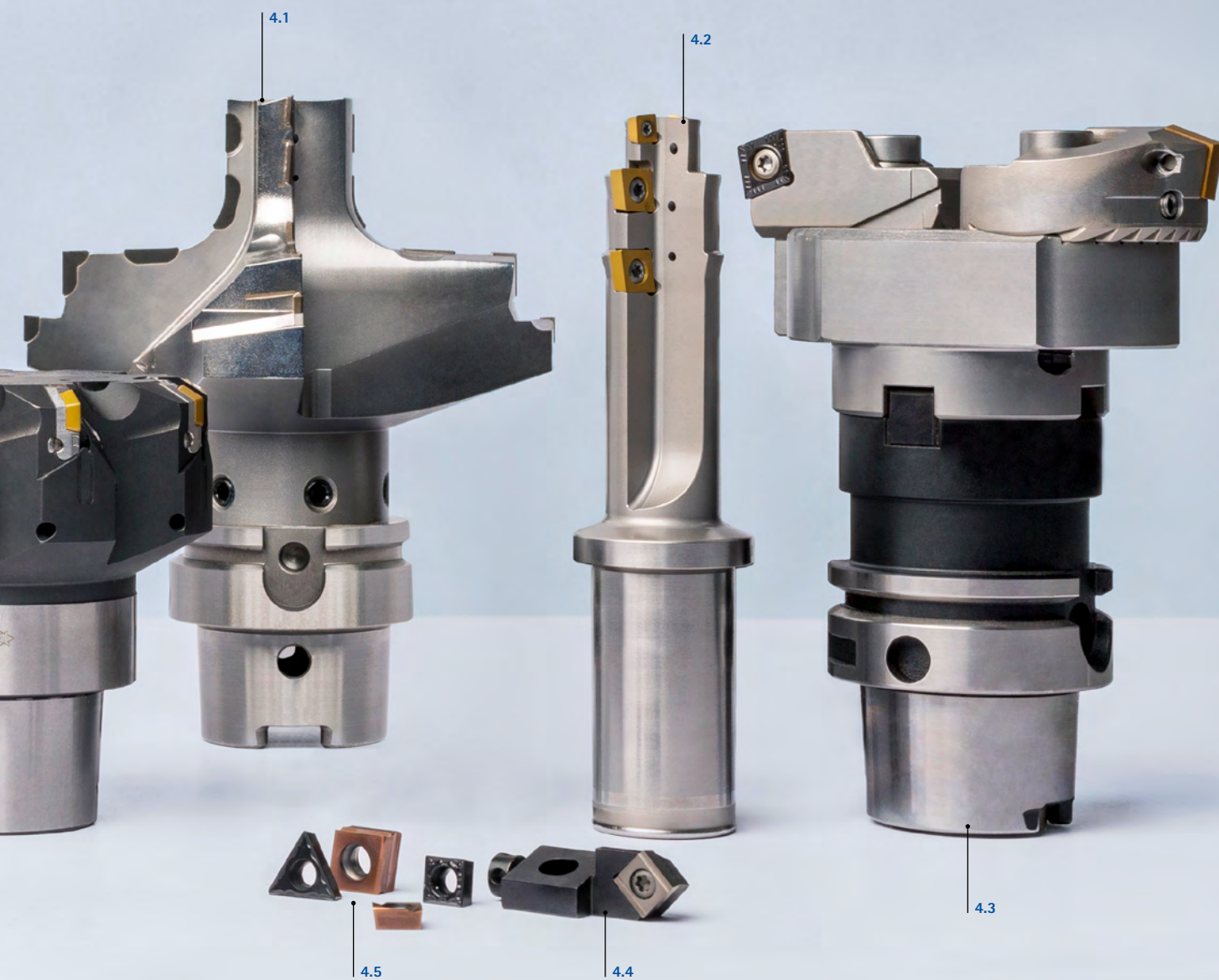

3 | Pogłębianie

3.1 Pogłębiacze stożkowe (od strony 586)

4 | Nawiercanie i toczenie

4.1 Rozwiązania specjalne z PCD (od strony 598)

4.2 Rozwiązania specjalne z płytkami skrawającymi (od strony 604)

4.3 ModulBore (od strony 613)

4.4 Oprawki narzędziowe (od strony 643)

4.5 Płytki skrawające (od strony 663)

WIERCENIE W PEŁNYM MATERIALE

Optymalne wiertła do niemal wszystkich zastosowań i materiałów obrabianych





PRZEGLĄD PRODUKTÓW

Do wiercenia w pełnym materiale MAPAL oferuje kompleksowy program standardowy do niemal wszystkich zadań obróbczych, składający się z wiertel z węgla spiekane i wiertel z wymienną głowicą. Program obejmuje zarówno wiertła uniwersalne, jak i narzędzia do obróbki żeliw, metali nieżelaznych, stali, materiałów lekkich lub trudno obrabialnych. W skład oferty wchodzi ponadto rozwiązanie do obróbki z wysokim posuwem (HSC) i wysoko wydajnej (HPC) z trzema ostrzami.

Odpowiedzią MAPAL na indywidualne wymagania klienta są specjalnie zaprojektowane wiertła z ostrzami PCD. Wiertła z węgla spiekane i z wymienną głowicą również mogą być dostosowane do potrzeb klienta. Dostępne na całym świecie usługi szlifierskie gwarantują oryginalną jakość i maksymalną ekonomiczność wszystkich narzędzi.



Basic Line:

Uniwersalne narzędzia, szeroki zakres zastosowań, niskie koszty nabycia



Performance Line:

Narzędzia wysoko wydajne, szeroki zakres zastosowania, zapewnia wysoką produktywność w produkcji seryjnej





Expert Line:

Narzędzia specjalistyczne do wybranych zastosowań, maksymalna precyzja i produktywność

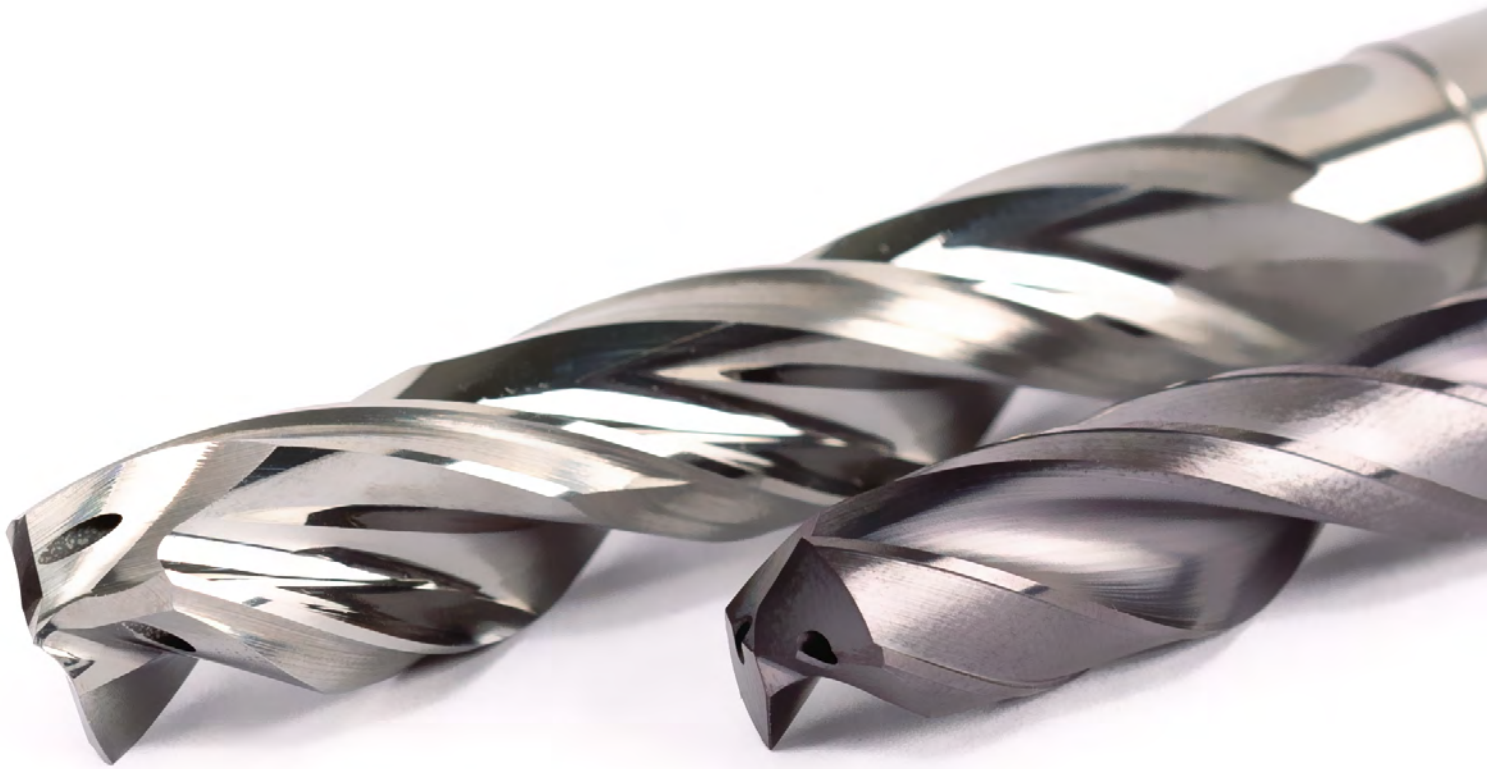
Wiertła			Nawiertaki
			
<p>Wiercenie w pełnym materiale wiertłem z węgla spiekane</p> <p>Wiertła z węgla spiekane do niemal wszystkich materiałów obrabianych w trzech różnych klasach wydajności.</p> <ul style="list-style-type: none"> - MEGA-Drill – dwuostrzowe wiertła z węgla spiekane z powłoką i geometrią dostosowaną do danego materiału obrabianego - Tritan-Drill – trójstrzowe wiertła zapewniające maksymalny posuw, z samocentrującym ścinem do wymagających zastosowań - ECU-Drill – najbardziej ekonomiczny program z bardzo dobrym stosunkiem ceny do jakości <p>Zakres \varnothing: 0,50 – 25,00 mm Głębokość wiercenia: 3xD 4xD 5xD 6xD 8xD 12xD</p> <p>P M K N C S H</p>	<p>Wiercenie w pełnym materiale systemem z wymienną głowiczką</p> <p>Wiercenie w pełnym materiale przy minimalnym zużyciu węgla spiekane oraz zapewnieniu maksymalnej stabilności i precyzji.</p> <ul style="list-style-type: none"> - Wiertło z płytkami skrawającymi QTD – ekonomiczne rozwiązanie z wymiennymi płytkami skrawającymi - Wiertło z wymienną głowicą TTD – dwuostrzowe wiertło z wymiennymi głowicami z pięcioma różnymi głowicami do wyboru - Wiertło z wymienną głowicą TTD-Tritan – nawet dwukrotnie większy posuw w porównaniu z dwuostrzowymi wiertłami z wymienną głowicą; wysoka stabilność procesu nawet w trudnych przypadkach <p>Zakres \varnothing: 9,00–50,00 mm Głębokość wiercenia: 1xD 1,5xD 3xD 5xD</p> <p>P M K N C S H</p>	<p>Wiercenie w pełnym materiale narzędziami z płytkami skrawającymi</p> <p>Wiercenie w pełnym aluminium wymiennymi płytkami skrawającymi z powłoką diamentową CVD.</p> <ul style="list-style-type: none"> - Trójstrzowe płytki skrawające z powłoką diamentową CVD zapewniają najwyższą produktywność i wydajność - Wiercenie w pełnym materiale w AlSi1 do AlSi12 - Z chłodzeniem wewnętrznym, możliwa również obróbka z użyciem minimalnej ilości środka chłodzącego – smarującego (MMS) - Indywidualne rozwiązania dla: \varnothing 16–54,9 mm <p>Zakres \varnothing: 16,00 – 54,90 mm Głębokość wiercenia: Do 3xD</p> <p>N</p>	<p>Nawiercanie</p> <p>Wykonywanie otworów centrujących wg DIN.</p> <ul style="list-style-type: none"> - Tritan-Spot-Drill – trójstrzowe nawiertaki do wymagających zastosowań, dostosowane do wiertel trójstrzowych - ECU-Centre-Drill – wykonywanie otworów centrujących zgodnych z DIN w elementach obrotowo-symetrycznych - CPD-Spot-Drill – dwuostrzowe wiertło centrujące ze złączem CFS <p>Zakres \varnothing: 0,50 – 20,00 mm</p> <p>P M K S</p>
Strona 29	Strona 183	Strona 239	Strona 245

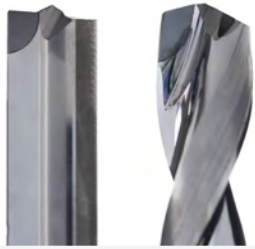

Wiertła stopniowane	Wiertła do głębokiego wiercenia	Wiertło-rozwiertak	Rozwiązania specjalne
			
<p>Wiercenie otworu stopniowanego</p> <p>Wykonywanie otworów pod gwint i fazowań do gwintów metrycznych.</p> <ul style="list-style-type: none"> - Tritan-Step-Drill – trzyostrzowe wiertła stopniowane z samocentryującym ścinem do obróbki otworów pod gwint - MEGA-Step-Drill – dwuostrzowe wiertła stopniowane do wykonywania otworów pod gwint <p>Zakres \varnothing: 2,50 – 17,50 mm</p> <p>P M</p>	<p>Wiercenie głębokich otworów</p> <p>Niezawodne i wydajne wiercenie głębokich otworów do 40xD.</p> <ul style="list-style-type: none"> - MEGA-Deep-Drill – wiertło do głębokiego wiercenia z chłodzeniem wewnętrznym do stabilnej obróbki głębokich otworów do 40xD - MEGA-Pilot-Drill – wiertło pilotujące, dostosowane do MEGA-Deep-Drill <p>Zakres \varnothing: 1,00 – 16,00 mm</p> <p>Głębokość wiercenia:</p> <p>12xD 20xD 25xD 30xD 40xD</p> <p>P M K N</p>	<p>Wiercenie i rozwiercanie w jednym kroku roboczym</p> <p>Wiercenie i rozwiercanie w jednym kroku roboczym.</p> <p>Tritan-Drill-Reamer:</p> <ul style="list-style-type: none"> - Najdokładniejsze rozwiązanie do jednoczesnego wiercenia i rozwiercania - Trzy ostrza i sześć łysinek - Samocentryjący ścin poprawia prowadzenie narzędzia podczas nawiercania - Wysoka dokładność pozycji narzędzia - Optymalna okrągłość - Z chłodzeniem wewnętrznym - Wersje z tolerancją $\pm 0,003$ mm i H7 <p>Zakres \varnothing: 3,80 – 20,05 mm</p> <p>Głębokość wiercenia:</p> <p>3xD 5xD</p> <p>P K N</p>	<p>Rozwiązania specjalne</p> <ul style="list-style-type: none"> - Indywidualne rozwiązania specjalne w zakresie wiertel z węgla spiekane do różnych zastosowań - Wiertła z ostrzami PCD zoptymalizowane pod kątem obróbki aluminium i CFK - Oferta obejmuje zarówno wiertła proste z rowkami prostymi z ostrzami PCD, jak i wiertła stopniowane spiralne z ostrzami PCD - Wiodące światowe centrum kompetencyjne w zakresie narzędzi PCD w Pforzheim
<p>Strona 257</p>	<p>Strona 267</p>	<p>Strona 289</p>	<p>Strona 300</p>

PRZEGLĄD TYPOSZEREGU

Wiercenie w pełnym materiale wiertłem z węgla spiekane

WIERTŁA MEGA

Dwuostrzowe wiertła z węgla spiekane z powłoką i geometrią dostosowaną do danego materiału obrabianego.



MEGA-Drill

- Powłoka i geometria dostosowana indywidualnie do każdego obrabianego materiału
- Szeroki zakres zastosowań
- Seria obejmuje wiertła do głębokiego wiercenia, wiertła stopniowe i mikrowiertła do wszystkich zastosowań

Klasa produktu:

Perfor
mance
LINE

Materiał obrabiany:

P M K
N C S H

Głębokość wiercenia:

3xD 4xD
5xD 8xD 12xD

Zakres ϕ : 0,50 - 25,00 mm



MEGA-Speed-Drill

- Wiertło o dużej prędkości z dwoma ostrzami
- Najwyższa precyzja szlifowania profilu rowka dla szybkiego usuwania wiórów
- Trzy łysinki pozwalają ograniczyć tarcie i wibracje

Klasa produktu:

Expert
LINE

Materiał obrabiany:

P M
K S

Głębokość wiercenia:

3xD 8xD
8xD 12xD

Zakres ϕ : 3,00 - 20,00 mm



MEGA-Quadro-Drill

- Cztery łysinki zapewniają najwyższą jakość otworu, współosiowość i dokładność pozycjonowania narzędzia
- Optymalna okrągłość i tolerancje średnicy

Klasa produktu:

Perfor
mance
LINE

Materiał obrabiany:

P
K

Głębokość wiercenia:

5xD
8xD 12xD

Zakres ϕ : 3,00 - 20,00 mm



MEGA-180°-Drill

- Wiercenie w pełnym materiale z zapewnieniem płaskiego dna otworu
- Nawiercanie powierzchni nachylonych pod kątem do 45°

Klasa produktu:

Expert
LINE

Materiał obrabiany:

P M
K N

Głębokość wiercenia:

3xD
5xD

Zakres ϕ : 3,00 - 20,00 mm



WIERTŁA TRITAN

Trójostrzowe wiertła zapewniające maksymalny posuw, z samocentryującym ścinem do wymagających zastosowań.



WIERTŁA ECU

Najbardziej ekonomiczny program z bardzo dobrym stosunkiem ceny do jakości.



Tritan-Drill

- Solidne narzędzia o stabilnych narożach
- Brak ruchów oscylacyjnych podczas obróbki
- Optymalna ewakuacja wiórów



Klasa produktu:



Materiał obrabiany:



Głębokość wiercenia:

3xD	8xD
8xD	12xD

Zakres \varnothing : 4,00 - 20,00 mm

ECU-Drill

- Program ekonomiczny
- Materiał skrawający i powłoki dostosowane do rodzaju obrabianego materiału



Klasa produktu:



Materiał obrabiany:



Głębokość wiercenia:

3xD	5xD
8xD	12xD













Zakres \varnothing : 3,00 - 20,00 mm

WYBÓR WIERTŁA

Wybór prawidłowego wiertła krok po kroku

Poszukują Państwo wiertła do obróbki stali hartowanej?

Ten przewodnik pokaże Państwu krok po kroku, jak dokonać właściwego wyboru wiertła.

1	Zastosowanie	Proszę wybrać rodzaj obróbki.	>		Wiercenie w pełnym materiale		Nawiercanie
2	Budowa	Proszę wybrać preferowaną wersję narzędzia.	>		Monolityczny		Złącze QTS
3	Klasa produktu	Proszę wybrać klasę produktu.	>		Basic Line: Uniwersalne narzędzia, szeroki zakres zastosowań, niskie koszty nabycia		
4	Grupa materiałowa	Proszę określić grupę materiału obrabianego wg kwalifikacji MAPAL (MZG). MZG znajdują Państwo na rozkładówce na końcu katalogu.	>		Stal		Stal nierdzewna
5	Cechy przedmiotu obrabianego	Proszę określić wymogi, jakie musi spełnić narzędzie.	>		Obróbka z wysokim posuwem		Obróbka z dużą prędkością
			>		Osiągalna tolerancja otworu $\geq IT$		Seria preferowana w tolerancji H7
6	Wersja	Proszę sprawdzić, czy cechy geometryczne narzędzia spełniają wymogi.	>		Zakres średnicy		Liczba ostrzy
7	Produkt	Należy wybrać odpowiednie wiertło. Produkty z magazynowej serii preferowanej są dostępne w krótkim terminie, natomiast produkty o parametrach możliwych do skonfigurowania mogą być konstruowane dowolnie w ramach wcześniej określonych zakresów.	>				Magazynowa seria preferowana



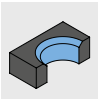

Wiertło stopniowe

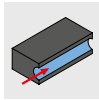

Wiercenie głębokich otworów

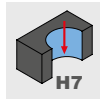

Wiercenie i rozwiercanie w jednym kroku roboczym



Złącze TTS



Złącze CFS



Z płytką skrawającą



Performance Line:
Narzędzia wysoko wydajne, szeroki zakres zastosowania, zapewnia wysoką produktywność w produkcji seryjnej



Expert Line:
Narzędzia specjalistyczne do wybranych zastosowań, maksymalna precyzja i produktywność



Żeliwo



Metale nieżelazne i tworzywa sztuczne

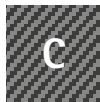

Materiały kompozytowe



Nadstopy i tytan



Stal utwardzana i staliwo

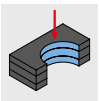

Wiercenie otworów w pakietach

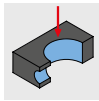

Wiercenie poprzeczne

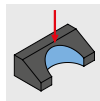

Skośny wlot otworu

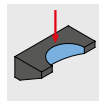

Skośny wylot otworu

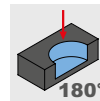

Plaskie dno otworu 180°



Tolerancja średnicy szlifowania narzędzia



Liczba lysinek



Doprowadzenie chłodziwa



Produkt z możliwością konfiguracji parametrów

BORE MACHINING | Drilling from solid 19

Step 1: Application Step 2: Design Step 3: Product category Step 4: Material suitability Step 5: Part features Step 6: Design

Design				Product			
ø [mm]	z	ngc*		Product name	Specification		Page
3 - 25	2	2	✓	MEGA-Drill-Steel-Plus	SCD600, 601		51
2 - 20	2	2	✓	MEGA-Drill-Inox	SCD120, 121		129
2,8 - 20	2	2	✓	MEGA-Drill-Alu	SCD131		151
2,55 - 20	2	2	✓	MEGA-Drill-Hardened	SCD140		82
0,5 - 12	2	2		MEGA-Drill-Composite-IMP	SCD250		156
0,8 - 2,99	2	2	✓	MICRO-Drill-Steel	SCD371		79

Arrows in the image point to the '6' in the Design table and the '7' in the Product table, indicating a link between design parameters and product specifications.

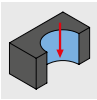

Wiercenie w pełnym materiale (1/2)

Budowa	Klasa produktu	Grupa materiałowa						Cechy wierzonego otworu							Głębokość wiercenia					
		P	M	K	N	C	S	H	HFC	HSC	180°	Tolerancja	3xD	4xD	5xD	6xD	8xD	12xD		
Performance LINE	Performance LINE	■	■	■	■	■	■	■			✓	✓		IT9	✓		✓		✓	
		■	■	■	■	■	■	■						IT9	✓		✓		✓	
		■	■	■	■	■	■	■						IT9	✓		✓		✓	✓
		■	■	■	■	■	■	■						IT9		✓				
		■	■	■	■	■	■	■						IT9			✓			
		■	■	■	■	■	■	■						IT9			✓		✓	✓
		■	■	■	■	■	■	■					✓		IT9			✓		✓
		■	■	■	■	■	■	■							IT9			✓		✓
		■	■	■	■	■	■	■							IT9			✓		✓
		■	■	■	■	■	■	■							IT9			✓		✓
Expert LINE	Expert LINE	■	■	■	■	■	■	■	✓		✓	✓	✓	IT9			✓		✓	✓
		■	■	■	■	■	■	■	✓		✓	✓	✓	IT9	✓		✓		✓	✓
		■	■	■	■	■	■	■		✓				IT9	✓		✓		✓	
		■	■	■	■	■	■	■		✓				IT9	✓		✓		✓	✓
		■	■	■	■	■	■	■		✓				IT9			✓		✓	✓
		■	■	■	■	■	■	■		✓				IT9			✓		✓	✓
		■	■	■	■	■	■	■		✓				IT9			✓		✓	✓
		■	■	■	■	■	■	■		✓				IT9	✓		✓		✓	✓
		■	■	■	■	■	■	■		✓				IT9	✓		✓		✓	✓
		■	■	■	■	■	■	■		✓				IT9	✓		✓		✓	✓
Basic LINE	Basic LINE	■	■	■	■	■	■	■					IT9		✓		✓			
		■	■	■	■	■	■	■					IT9	✓		✓		✓	✓	
		■	■	■	■	■	■	■					IT9			✓		✓		

Krok 1:
Zastosowanie



Krok 2:
Budowa



Krok 3:
Klasa produktu



Krok 4:
Grupa materiałowa



Krok 5:
Cechy przedmiotu obrabianego



Krok 6:
Wersja



	Wersja				Produkt			
	ø [mm]	z	η _{FF} *		Nazwa produktu	Specyfikacja		Strona
	3 - 25	2	2	✓	MEGA-Drill-Steel-Plus	SCD600, 601		51
	2 - 20	2	2	✓	MEGA-Drill-Inox	SCD120, 121		129
	2,8 - 20	2	2	✓	MEGA-Drill-Alu	SCD131		151
	2,55 - 20	2	2		MEGA-Drill-Hardened	SCD140		82
	0,5 - 12	2	2		MEGA-Drill-Composite-MD	SCD250		156
	0,8 - 2,99	2	2	✓	MICRO-Drill-Steel	SCD371		79
	3 - 20	2	4	✓	MEGA-Quadro-Drill-Plus	SCD610, 611		70
	4 - 20	3	3	✓	Tritan-Drill-Uni-Plus	SCD631		30
	4 - 20	3	3	✓	Tritan-Drill-Steel	SCD661		85
	3 - 20	2	3	✓	MEGA-Speed-Drill-Uni	SCD221		36
	3 - 20	2	3	✓	MEGA-Speed-Drill-Steel	SCD621		95
	3 - 20	2	3	✓	MEGA-Speed-Drill-Inox	SCD411		142
	3 - 20	2	3	✓	MEGA-Speed-Drill-Iron	SCD421		150
	3 - 20	2	4	✓	MEGA-180°-Drill	SCD231		105
	3 - 20	2	4	✓	MEGA-180°-Drill-Alu	SCD241		160
	3 - 12	2	2		MEGA-Drill-Composite-UDX	SCD270, 271		158
	3 - 20	2	2	✓	ECU-Drill-Uni	SCD350, 351		42
	3 - 20	2	2	✓	ECU-Drill-Steel	SCD360, 361		111
	4,8 - 11,6	2	4	✓	ECU-G-Drill	SCD211		164

* η_{FF} = liczba łysinek



Wiercenie w pełnym materiale (2/2)

Budowa	Klasa produktu	Grupa materiałowa						Cechy wierzonego otworu							Głębokość wiercenia														
		P	M	K	N	C	S	H	HFC	HSC	180°	Tolerancja	1xD	1,5xD	3xD	5xD	8xD	12xD											
	Performance LINE	■		■									IT9	✓		✓	✓	✓	✓										
		■		■										IT9	✓		✓	✓	✓	✓									
		■	■	■	■			■						IT9	✓		✓	✓	✓	✓									
					■										IT9	✓		✓	✓	✓	✓								
						■									IT9	✓		✓	✓	✓	✓								
	Expert LINE	■		■					✓		✓	✓	✓	✓			✓	✓	✓										
	Performance LINE	■		■							✓	✓								IT10		✓	✓	✓	✓	✓			
		■		■																	IT10		✓	✓	✓	✓	✓		
		■		■																	IT10		✓	✓	✓	✓	✓		
		■	■	■																	IT10		✓	✓	✓	✓	✓		
					■																	IT10		✓	✓	✓	✓	✓	
						■																IT10		✓	✓	✓	✓	✓	
					■															IT9	✓	✓	✓						

Krok 1:
Zastosowanie



Krok 2:
Budowa



Krok 3:
Klasa produktu



Krok 4:
Grupa materiałowa



Krok 5:
Cechy przedmiotu obrabianego



Krok 6:
Wersja



	Wersja				Produkt			
	ø [mm]	z	η _{FF} *		Nazwa produktu	Specyfikacja		Strona
	12 - 45	2	4	✓	Wymienna głowica TTD Uni-Plus	01P-Uni-Plus		206
	12 - 45	2	3	✓	Wymienna głowica TTD Steel	04-Steel		207
	12 - 45	2	3	✓	Wymienna głowica TTD Inox	02-Inox		209
	12 - 45	2	4	✓	Wymienna głowica TTD Iron	05-Iron		211
	12 - 45	2	4	✓	Wymienna głowica TTD Alu	03-Alu		212
	12 - 32,49	3	3	✓	Wymienna głowica TTD-Tritan Uni	01-Uni		230
	9 - 50	2	2	✓	Płytki skrawająca QTD Steel	01-Steel		186
	14 - 32	2	2	✓	Płytki skrawająca QTD Steel-Pyramid	05-Pyramid		188
	10 - 33	2	2	✓	Płytki skrawająca QTD Uni, kształt EK	10-Uni		190
	9 - 50	2	2	✓	Płytki skrawająca QTD Inox	02-Inox		191
	9 - 50	2	2	✓	Płytki skrawająca QTD Iron	04-Iron		193
	9 - 50	2	2	✓	Płytki skrawająca QTD Alu	03-Alu		194
	16 - 54,9	1	4	✓	Płytki skrawająca WOGT	WOGT-X40		241

* η_{FF} = liczba łysinek

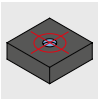

Nawiercanie

Budowa	Klasa produktu	Grupa materiałowa						Cechy wierzonego otworu							Głębokość wiercenia										
		P	M	K	N	C	S	H	HFC	HSC	[Diagram]		[Diagram]		[Diagram]		[Diagram]		1xD	1,5xD	3xD	5xD	8xD	12xD	
	Expert LINE	■	■	■	■		■	■																	
	Basic LINE	■	■		■		■																		
	Basic LINE	■	■	■	■		■																		

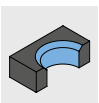

Wiercenie otworów stopniowanych

Budowa	Klasa produktu	Grupa materiałowa						Cechy wierzonego otworu							Głębokość wiercenia										
		P	M	K	N	C	S	H	HFC	HSC	[Diagram]		[Diagram]		[Diagram]		[Diagram]		1xD	1,5xD	3xD	5xD	8xD	12xD	
	Expert LINE	■	■	■					✓																
	Performance LINE	■		■				■																	

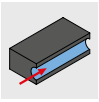

Wiercenie głębokich otworów

Budowa	Klasa produktu	Grupa materiałowa						Cechy wierzonego otworu							Głębokość wiercenia										
		P	M	K	N	C	S	H	HFC	HSC	[Diagram]		[Diagram]		[Diagram]		[Diagram]		15xD	20xD	25xD	30xD	40xD		
	Performance LINE	■	■	■			■																		
	Performance LINE	■		■										✓							✓	✓	✓	✓	✓
	Performance LINE				■								✓								✓	✓	✓	✓	

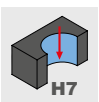

Wiercenie i rozwiercanie w jednym kroku roboczym

Budowa	Klasa produktu	Grupa materiałowa						Cechy wierzonego otworu							Głębokość wiercenia										
		P	M	K	N	C	S	H	HFC	HSC	[Diagram]		[Diagram]		[Diagram]		[Diagram]		1xD	1,5xD	3xD	5xD	8xD	12xD	
	Expert LINE	■		■							✓	✓	✓	✓								✓	✓		

■ wysoce przydatny

□ warunkowo przydatny

Krok 1:
Zastosowanie



Krok 2:
Budowa



Krok 3:
Klasa produktu



Krok 4:
Grupa materiałowa



Krok 5:
Cechy przedmiotu obrabianego



Krok 6:
Wersja



	Wersja				Produkt			
	ø [mm]	z	η_{FF}^*		Nazwa produktu	Specyfikacja		Strona
	4 - 20	3	0		Tritan-Spot-Drill-Steel	SCD670		246
	0,5 - 2,5	2	2		ECU-Centre-Drill	SCD450		248
	8 - 20	2	0		CPD-Spot-Drill	CPD100		249

	Wersja				Produkt			
	ø [mm]	z	η_{FF}^*		Nazwa produktu	Specyfikacja		Strona
	3,98 - 17,50	3	3	✓	Tritan-Step-Drill-Steel	SCD561		258
	2,5 - 14	2	2	✓	MEGA-Step-Drill-Steel-Plus	SCD590, 591		259

	Wersja				Produkt			
	ø [mm]	z	η_{FF}^*		Nazwa produktu	Specyfikacja		Strona
	1 - 3	2	2	✓	MEGA-Pilot-Drill	SCD581		268
	1 - 16	2	4	✓	MEGA-Deep-Drill	SCD171		269
	3 - 12	2	4	✓	MEGA-Deep-Drill-Alu	SCD181		278

	Wersja				Produkt			
	ø [mm]	z	η_{FF}^*		Nazwa produktu	Specyfikacja		Strona
	3,80 - 20,05	3		✓	Tritan-Drill-Reamer	SDR301		292

* η_{FF} = liczba łysinek

Oznaczenia

Wiertła z węgla spiekane

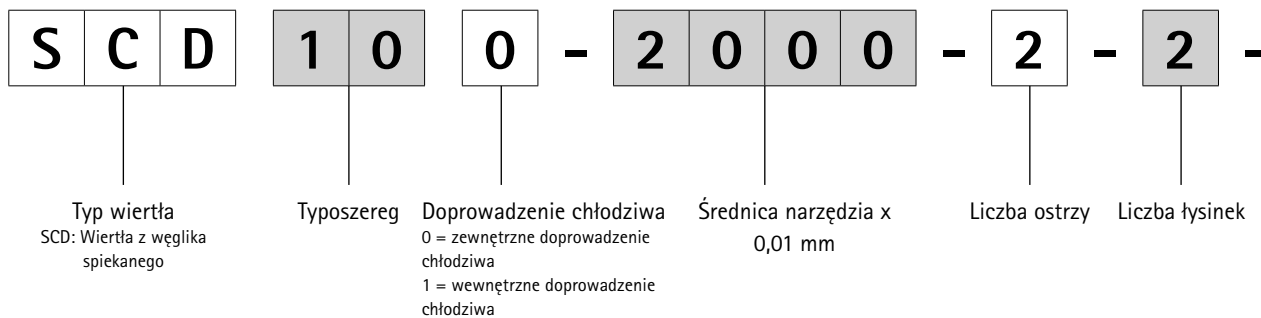

Wiertło-rozwiertak

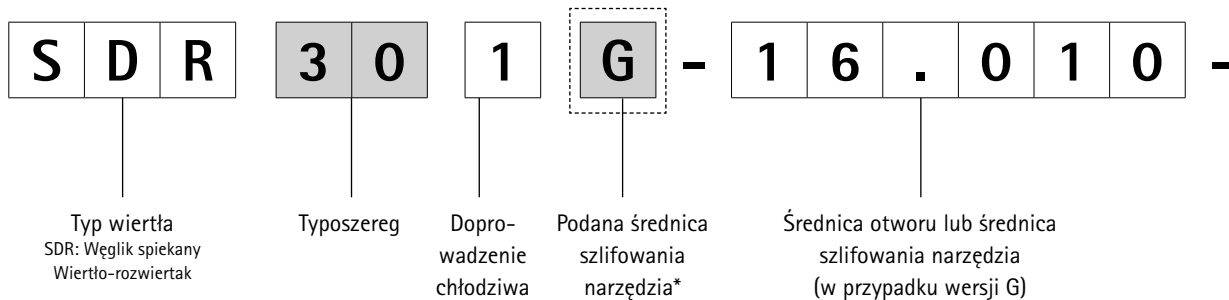

System wymiany płytki QTD i TTD

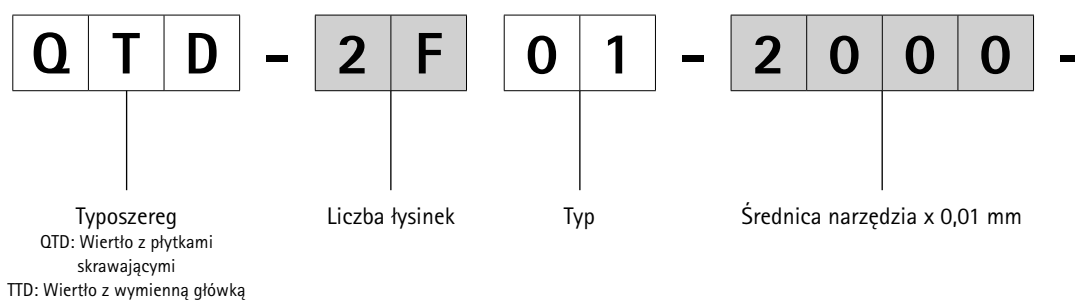

* miejsce zajęte tylko w przypadku wersji G

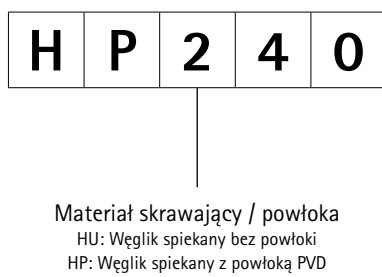
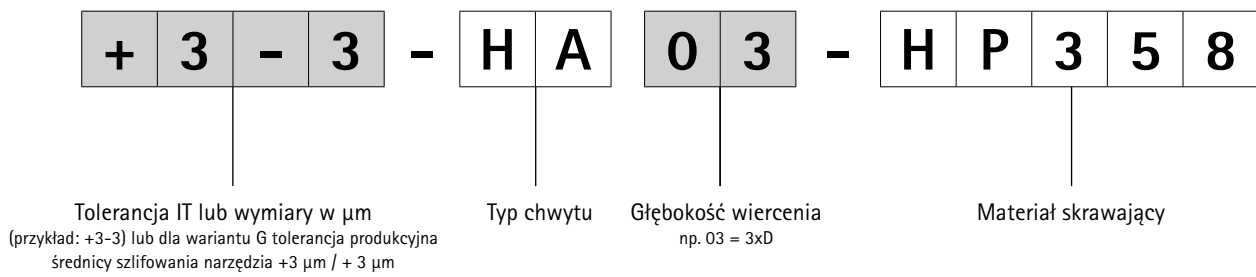
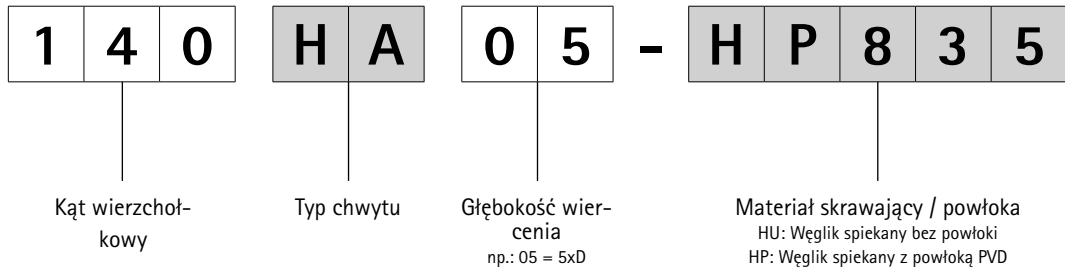

Oznaczenia

System wymiany płytki TTD-Tritan

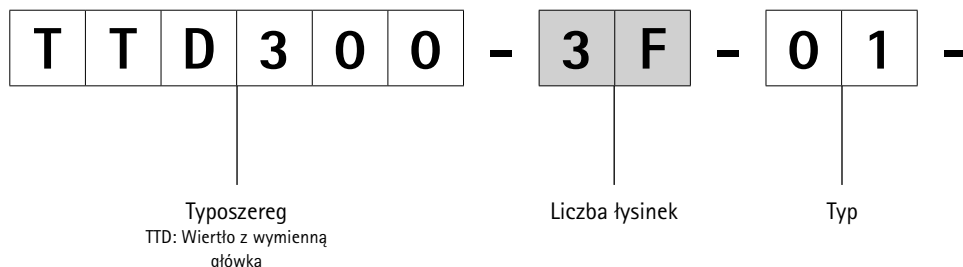

Program uchwytów TTS do wiertel TTD-Tritan

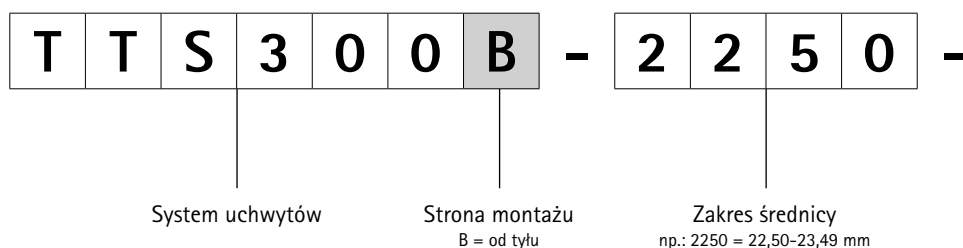

Program uchwytów QTS do wiertel QTD

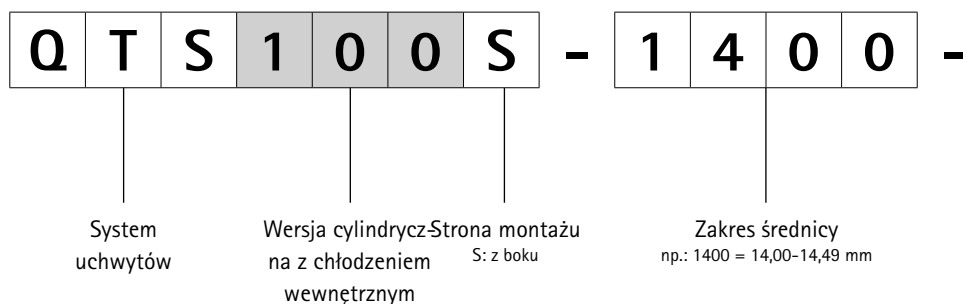

Program uchwytów TTS do wiertel TTD

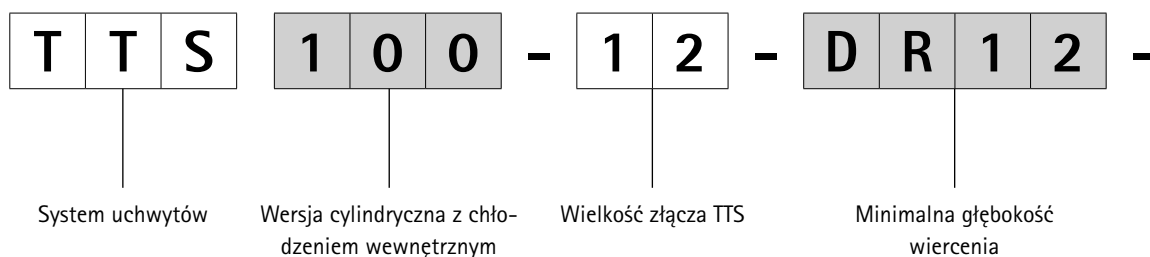

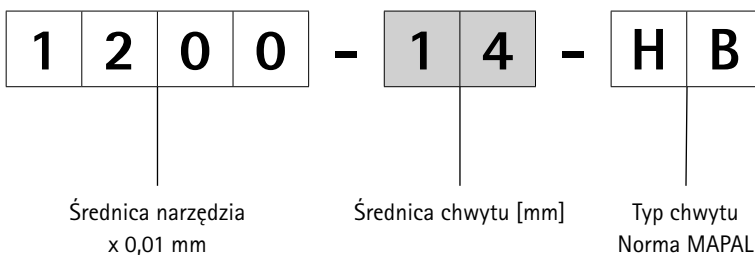
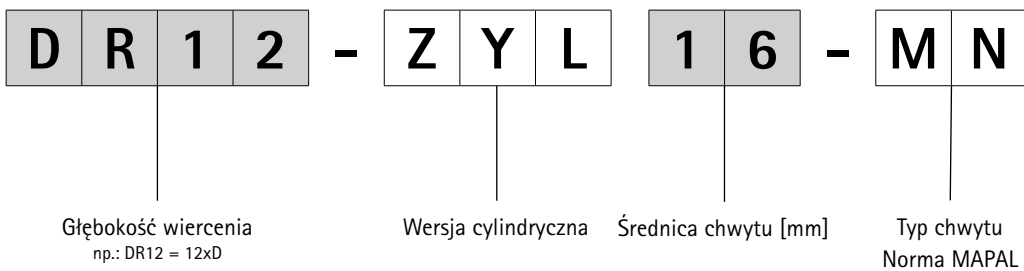
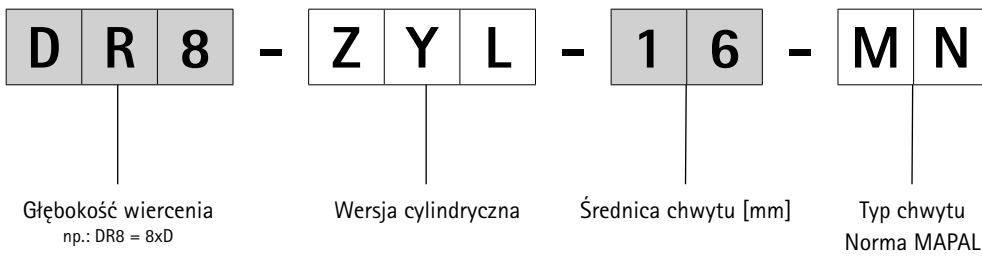
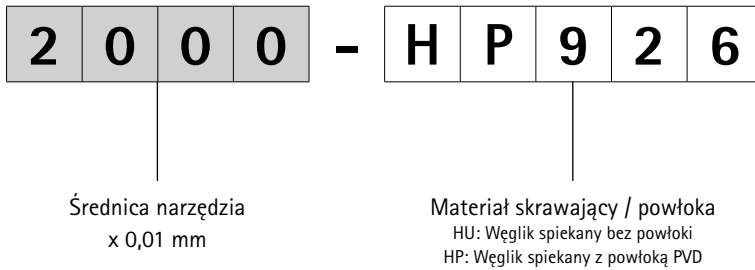



WIERCENIE W PEŁNYM MATERIALE WIERTŁEM Z WĘGLIKA SPIEKANEGO

Uniwersalne zastosowanie

Tritan-Drill-Uni-Plus	30
MEGA-Speed-Drill-Uni	36
ECU-Drill-Uni	42

Stal i stal utwardzana

MEGA-Drill-Steel-Plus	51
MEGA-Quadro-Drill-Plus	70
MICRO-Drill-Steel	79
MEGA-Drill-Hardened	82
Tritan-Drill-Steel	85
MEGA-Speed-Drill-Steel	95
MEGA-180°-Drill	105
ECU-Drill-Steel	111

Stal nierdzewna i żeliwo

MEGA-Drill-Inox	129
MEGA-Speed-Drill-Inox	142
MEGA-Speed-Drill-Iron	150

Aluminium i materiały kompozytowe

MEGA-Drill-Alu	151
MEGA-Drill-Composite-MD	156
MEGA-Drill-Composite-UDX	158
MEGA-180°-Drill-Alu	160
ECU-G-Drill	164

Aneks techniczny

Zalecane parametry skrawania	166
------------------------------------	-----



Tritan-Drill-Uni-Plus

Wiertła spiralne z węgla spiekane

SCD631 (5xD), wewnętrzne doprowadzenie chłodziwa, następcą Tritan-Drill-Uni (SCD44)

Wersja:

Średnica wiertła: 4,00 – 20,00 mm

Tolerancja otworu: IT 9 (osiągalne)

Materiał skrawający: HP358

Liczba ostrzy: 3

Liczba łysinek: 3

Kąt wierzchołkowy: 140°

Kąt spirali: 30°

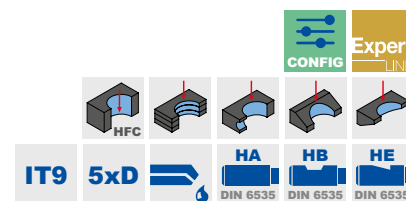
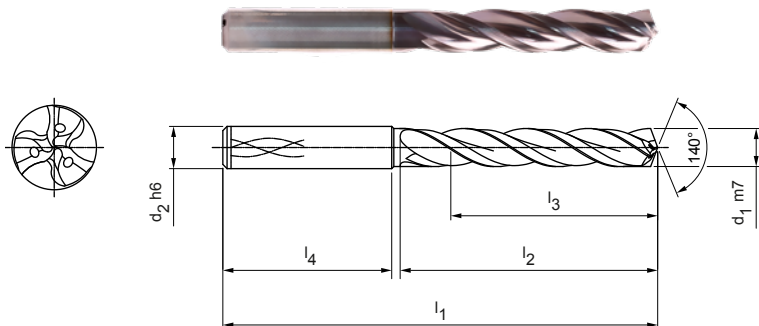

Magazynowa seria preferowana z chwytem typu HA

Wymiary						Typ chwytu HA	
d ₁ m7	d ₂ h6	l ₁	l ₂	l ₃	l ₄	Specyfikacja	Nr materiałowy
4,00	6	74	36	29	36	SCD631-0400-3-3-140HA05-HP358	31037282
4,10	6	74	36	29	36	SCD631-0410-3-3-140HA05-HP358	31037283
4,20	6	74	36	29	36	SCD631-0420-3-3-140HA05-HP358	31037284
4,30	6	74	36	29	36	SCD631-0430-3-3-140HA05-HP358	31037285
4,50	6	74	36	29	36	SCD631-0450-3-3-140HA05-HP358	31037287
4,80	6	82	44	35	36	SCD631-0480-3-3-140HA05-HP358	31037290
5,00	6	82	44	35	36	SCD631-0500-3-3-140HA05-HP358	31037292
5,10	6	82	44	35	36	SCD631-0510-3-3-140HA05-HP358	31037293
5,20	6	82	44	35	36	SCD631-0520-3-3-140HA05-HP358	31037294
5,30	6	82	44	35	36	SCD631-0530-3-3-140HA05-HP358	31037295
5,50	6	82	44	35	36	SCD631-0550-3-3-140HA05-HP358	31037297
5,55	6	82	44	35	36	SCD631-0555-3-3-140HA05-HP358	31307521
5,60	6	82	44	35	36	SCD631-0560-3-3-140HA05-HP358	31037298
5,70	6	82	44	35	36	SCD631-0570-3-3-140HA05-HP358	31037299
5,80	6	82	44	35	36	SCD631-0580-3-3-140HA05-HP358	31037300
5,90	6	82	44	35	36	SCD631-0590-3-3-140HA05-HP358	31037301
6,00	6	82	44	35	36	SCD631-0600-3-3-140HA05-HP358	31037302
6,10	8	91	53	43	36	SCD631-0610-3-3-140HA05-HP358	31037303
6,20	8	91	53	43	36	SCD631-0620-3-3-140HA05-HP358	31037304
6,30	8	91	53	43	36	SCD631-0630-3-3-140HA05-HP358	31037305
6,40	8	91	53	43	36	SCD631-0640-3-3-140HA05-HP358	31037306
6,50	8	91	53	43	36	SCD631-0650-3-3-140HA05-HP358	31037307
6,70	8	91	53	43	36	SCD631-0670-3-3-140HA05-HP358	31037309
6,80	8	91	53	43	36	SCD631-0680-3-3-140HA05-HP358	31037310
6,90	8	91	53	43	36	SCD631-0690-3-3-140HA05-HP358	31037311
7,00	8	91	53	43	36	SCD631-0700-3-3-140HA05-HP358	31037312
7,40	8	91	53	43	36	SCD631-0740-3-3-140HA05-HP358	31037316
7,50	8	91	53	43	36	SCD631-0750-3-3-140HA05-HP358	31037317
7,70	8	91	53	43	36	SCD631-0770-3-3-140HA05-HP358	31037319
7,80	8	91	53	43	36	SCD631-0780-3-3-140HA05-HP358	31037320
7,90	8	91	53	43	36	SCD631-0790-3-3-140HA05-HP358	31037321
8,00	8	91	53	43	36	SCD631-0800-3-3-140HA05-HP358	31037322
8,10	10	103	61	49	40	SCD631-0810-3-3-140HA05-HP358	31037323
8,50	10	103	61	49	40	SCD631-0850-3-3-140HA05-HP358	31037327
8,60	10	103	61	49	40	SCD631-0860-3-3-140HA05-HP358	31037328

Tritan-Drill-Uni-Plus | Wiertła spiralne z węgla spiekane SCD631 (5xD), wewnętrzne doprowadzenie chłodziwa

Wymiary						Typ chwytu HA	
d ₁ m7	d ₂ h6	l ₁	l ₂	l ₃	l ₄	Specyfikacja	Nr materiałowy
8,80	10	103	61	49	40	SCD631-0880-3-3-140HA05-HP358	31037330
9,00	10	103	61	49	40	SCD631-0900-3-3-140HA05-HP358	31037332
9,30	10	103	61	49	40	SCD631-0930-3-3-140HA05-HP358	31037335
9,50	10	103	61	49	40	SCD631-0950-3-3-140HA05-HP358	31037337
9,80	10	103	61	49	40	SCD631-0980-3-3-140HA05-HP358	31037340
9,90	10	103	61	49	40	SCD631-0990-3-3-140HA05-HP358	31037341
10,00	10	103	61	49	40	SCD631-1000-3-3-140HA05-HP358	31037342
10,20	12	118	71	56	45	SCD631-1020-3-3-140HA05-HP358	31037344
10,50	12	118	71	56	45	SCD631-1050-3-3-140HA05-HP358	31037347
11,00	12	118	71	56	45	SCD631-1100-3-3-140HA05-HP358	31037352
11,20	12	118	71	56	45	SCD631-1120-3-3-140HA05-HP358	31037354
11,50	12	118	71	56	45	SCD631-1150-3-3-140HA05-HP358	31037357
11,70	12	118	71	56	45	SCD631-1170-3-3-140HA05-HP358	31037359
11,80	12	118	71	56	45	SCD631-1180-3-3-140HA05-HP358	31037360
12,00	12	118	71	56	45	SCD631-1200-3-3-140HA05-HP358	31037362
12,50	14	124	77	60	45	SCD631-1250-3-3-140HA05-HP358	31037364
13,00	14	124	77	60	45	SCD631-1300-3-3-140HA05-HP358	31037366
13,50	14	124	77	60	45	SCD631-1350-3-3-140HA05-HP358	31037368
13,80	14	124	77	60	45	SCD631-1380-3-3-140HA05-HP358	31037369
14,00	14	124	77	60	45	SCD631-1400-3-3-140HA05-HP358	31037370
14,50	16	133	83	63	48	SCD631-1450-3-3-140HA05-HP358	31037372
14,80	16	133	83	63	48	SCD631-1480-3-3-140HA05-HP358	31037373
15,00	16	133	83	63	48	SCD631-1500-3-3-140HA05-HP358	31037374
15,50	16	133	83	63	48	SCD631-1550-3-3-140HA05-HP358	31037376
16,00	16	133	83	63	48	SCD631-1600-3-3-140HA05-HP358	31037378
17,00	18	143	93	71	48	SCD631-1700-3-3-140HA05-HP358	31037382
17,50	18	143	93	71	48	SCD631-1750-3-3-140HA05-HP358	31037384
18,00	18	143	93	71	48	SCD631-1800-3-3-140HA05-HP358	31037386
18,50	20	153	101	77	50	SCD631-1850-3-3-140HA05-HP358	31037388
19,80	20	153	101	77	50	SCD631-1980-3-3-140HA05-HP358	31037393
20,00	20	153	101	77	50	SCD631-2000-3-3-140HA05-HP358	31037394

Możliwość konfiguracji parametrów



Średnica:
możliwość wyboru średnicy w krokach
co 0,01 mm





Typ chwytu:
Typ chwytu: HB | HE

Specyfikacja:
SCD631-[średnica]-3-3-140[typ chwytu]05-HP358

Wymiary typoszeregu z możliwością konfiguracji parametrów

d ₁ min.	d ₁ max.	d ₂ h6	l ₁	l ₂	l ₃	l ₄
4,00	4,70	6	74	36	29	36
4,71	6,00	6	82	44	35	36
6,01	8,00	8	91	53	43	36
8,01	10,00	10	103	61	49	40
10,01	12,00	12	118	71	56	45
12,01	14,00	14	124	77	60	45
14,01	16,00	16	133	83	63	48
16,01	18,00	18	143	93	71	48
18,01	20,00	20	153	101	77	50

Przykład:

SCD631-0431-3-3-140HE05-HP358

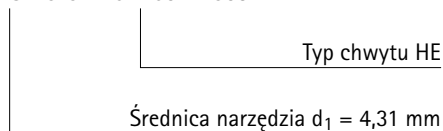

Wymiary podano w mm.

Zalecane parametry skrawania - patrz koniec rozdziału.

Wersje specjalne i inne powłoki wg zapytania ofertowego.

Tritan-Drill-Uni-Plus

Wiertła spiralne z węgla spiekane

SCD631 (8xD), wewnętrzne doprowadzenie chłodziwa, następcą Tritan-Drill-Uni (SCD44)

Wersja:

Średnica wiertła: 4,00 – 20,00 mm

Tolerancja otworu: IT 9 (osiągalne)

Materiał skrawający: HP358

Liczba ostrzy: 3

Liczba łysinek: 3

Kąt wierchołkowy: 135°

Kąt spirali: 30°

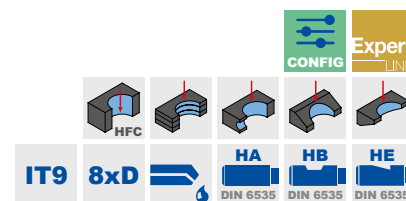
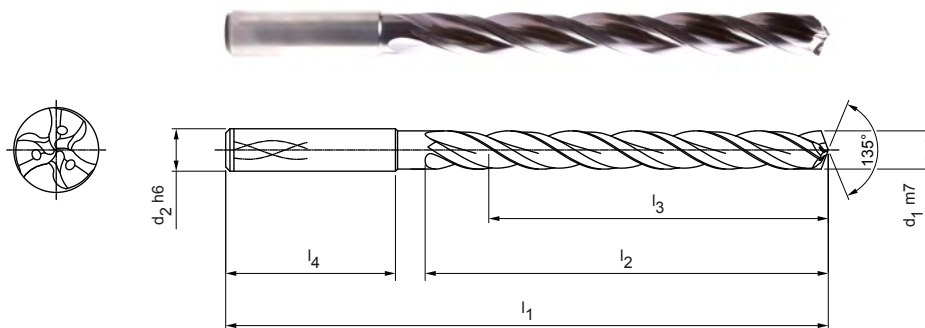

Magazynowa seria preferowana z typem chwytu HA

Wymiary						Typ chwytu HA	
d ₁ m7	d ₂ h6	l ₁	l ₂	l ₃	l ₄	Specyfikacja	Nr materiałowy
4,00	6	81	43	36	36	SCD631-0400-3-3-135HA08-HP358	31037395
4,10	6	81	43	36	36	SCD631-0410-3-3-135HA08-HP358	31037396
4,30	6	81	43	36	36	SCD631-0430-3-3-135HA08-HP358	31037398
4,50	6	81	43	36	36	SCD631-0450-3-3-135HA08-HP358	31037400
4,60	6	81	43	36	36	SCD631-0460-3-3-135HA08-HP358	31037401
4,70	6	81	43	36	36	SCD631-0470-3-3-135HA08-HP358	31037402
4,90	6	95	57	48	36	SCD631-0490-3-3-135HA08-HP358	31037404
5,00	6	95	57	48	36	SCD631-0500-3-3-135HA08-HP358	31037405
5,03	6	95	57	48	36	SCD631-0503-3-3-135HA08-HP358	31266415
5,10	6	95	57	48	36	SCD631-0510-3-3-135HA08-HP358	31037406
5,20	6	95	57	48	36	SCD631-0520-3-3-135HA08-HP358	31037407
5,50	6	95	57	48	36	SCD631-0550-3-3-135HA08-HP358	31037410
5,60	6	95	57	48	36	SCD631-0560-3-3-135HA08-HP358	31037411
5,80	6	95	57	48	36	SCD631-0580-3-3-135HA08-HP358	31037413
6,00	6	95	57	48	36	SCD631-0600-3-3-135HA08-HP358	31037415
6,10	8	114	76	64	36	SCD631-0610-3-3-135HA08-HP358	31037416
6,50	8	114	76	64	36	SCD631-0650-3-3-135HA08-HP358	31037420
6,80	8	114	76	64	36	SCD631-0680-3-3-135HA08-HP358	31037423
6,90	8	114	76	64	36	SCD631-0690-3-3-135HA08-HP358	31037424
7,00	8	114	76	64	36	SCD631-0700-3-3-135HA08-HP358	31037425
7,10	8	114	76	64	36	SCD631-0710-3-3-135HA08-HP358	31037426
7,50	8	114	76	64	36	SCD631-0750-3-3-135HA08-HP358	31037430
7,80	8	114	76	64	36	SCD631-0780-3-3-135HA08-HP358	31037433
7,90	8	114	76	64	36	SCD631-0790-3-3-135HA08-HP358	31037434
8,00	8	114	76	64	36	SCD631-0800-3-3-135HA08-HP358	31037435
8,50	10	142	95	80	40	SCD631-0850-3-3-135HA08-HP358	31037440
8,80	10	142	95	80	40	SCD631-0880-3-3-135HA08-HP358	31037443
9,00	10	142	95	80	40	SCD631-0900-3-3-135HA08-HP358	31037445
9,10	10	142	95	80	40	SCD631-0910-3-3-135HA08-HP358	31037446
9,40	10	142	95	80	40	SCD631-0940-3-3-135HA08-HP358	31037449
9,50	10	142	95	80	40	SCD631-0950-3-3-135HA08-HP358	31037450
9,80	10	142	95	80	40	SCD631-0980-3-3-135HA08-HP358	31037453
10,00	10	142	95	80	40	SCD631-1000-3-3-135HA08-HP358	31037455
11,00	12	162	114	96	45	SCD631-1100-3-3-135HA08-HP358	31037465
11,80	12	162	114	96	45	SCD631-1180-3-3-135HA08-HP358	31037473

Tritan-Drill-Uni-Plus | Wiertła spiralne z węgla spiekane SCD631 (8xD), wewnętrzne doprowadzenie chłodziwa

Wymiary						Typ chwytu HA	
d ₁ m7	d ₂ h6	l ₁	l ₂	l ₃	l ₄	Specyfikacja	Nr materiałowy
12,00	12	162	114	96	45	SCD631-1200-3-3-135HA08-HP358	31037475
12,50	14	178	133	112	45	SCD631-1250-3-3-135HA08-HP358	31037477
13,00	14	178	133	112	45	SCD631-1300-3-3-135HA08-HP358	31037479
13,50	14	178	133	112	45	SCD631-1350-3-3-135HA08-HP358	31037481
14,00	14	178	133	112	45	SCD631-1400-3-3-135HA08-HP358	31037483
15,00	16	203	152	128	48	SCD631-1500-3-3-135HA08-HP358	31037487
16,00	16	203	152	128	48	SCD631-1600-3-3-135HA08-HP358	31037491
17,00	18	222	171	144	48	SCD631-1700-3-3-135HA08-HP358	31037495

Możliwość konfiguracji parametrów



Średnica:
możliwość wyboru średnicy w krokach
co 0,01 mm





Typ chwytu:
Typ chwytu: HB | HE

Specyfikacja:
SCD631-[średnica]-3-3-140[typ chwytu]08-HP358

Wymiary typoszeregu z możliwością konfiguracji parametrów

d ₁ min.	d ₁ max.	d ₂ h6	l ₁	l ₂	l ₃	l ₄
4,00	4,70	6	81	43	36	36
4,71	6,00	6	95	57	48	36
6,01	8,00	8	114	76	64	36
8,01	10,00	10	142	95	80	40
10,01	12,00	12	162	114	96	45
12,01	14,00	14	178	133	112	45
14,01	16,00	16	203	152	128	48
16,01	18,00	18	222	171	144	48
18,01	20,00	20	243	190	160	50

Przykład:

SCD631-0431-3-3-140HE08-HP358

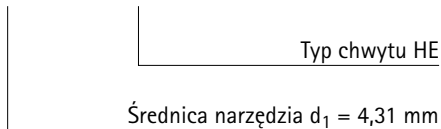

Wymiary podano w mm.

Zalecane parametry skrawania - patrz koniec rozdziału.

Wersje specjalne i inne powłoki wg zapytania ofertowego.

Tritan-Drill-Uni-Plus

Wiertła spiralne z węgla spiekane

SCD631 (12xD), wewnętrzne doprowadzenie chłodziwa, następca Tritan-Drill-Uni (SCD44)

Wersja:

Średnica wiertła: 4,00 – 20,00 mm

Tolerancja otworu: IT 9 (osiągalne)

Materiał skrawający: HP358

Liczba ostrzy: 3

Liczba łysinek: 3

Kąt wierzchołkowy: 135°

Kąt spirali: 30°

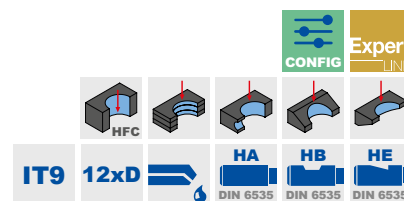
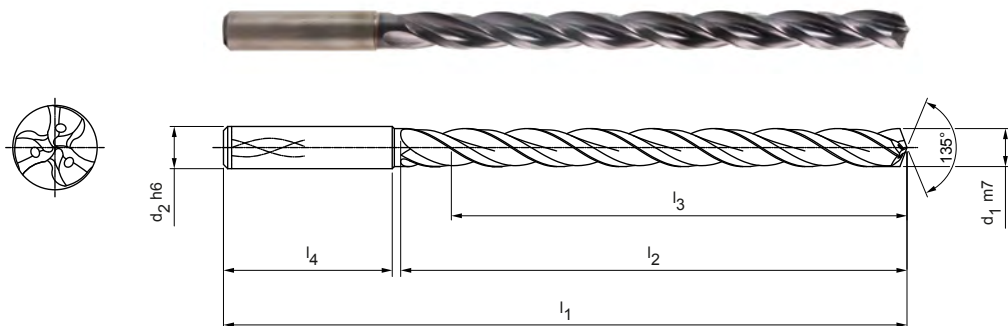

Magazynowa seria preferowana z typem chwytu HA

Wymiary						Typ chwytu HA	
d ₁ m7	d ₂ h6	l ₁	l ₂	l ₃	l ₄	Specyfikacja	Nr materiałowy
4,00	6	102	64	58	36	SCD631-0400-3-3-135HA12-HP358	31035357
4,10	6	102	64	58	36	SCD631-0410-3-3-135HA12-HP358	31035358
4,20	6	102	64	58	36	SCD631-0420-3-3-135HA12-HP358	31035359
4,30	6	102	64	58	36	SCD631-0430-3-3-135HA12-HP358	31035360
4,50	6	102	64	58	36	SCD631-0450-3-3-135HA12-HP358	31035362
4,60	6	102	64	58	36	SCD631-0460-3-3-135HA12-HP358	31035363
4,70	6	102	64	58	36	SCD631-0470-3-3-135HA12-HP358	31035364
4,80	6	116	78	70	36	SCD631-0480-3-3-135HA12-HP358	31035365
5,00	6	116	78	70	36	SCD631-0500-3-3-135HA12-HP358	31035367
5,10	6	116	78	70	36	SCD631-0510-3-3-135HA12-HP358	31035368
5,20	6	116	78	70	36	SCD631-0520-3-3-135HA12-HP358	31035369
5,40	6	116	78	70	36	SCD631-0540-3-3-135HA12-HP358	31035371
5,50	6	116	78	70	36	SCD631-0550-3-3-135HA12-HP358	31035372
5,80	6	116	78	70	36	SCD631-0580-3-3-135HA12-HP358	31035375
6,00	6	116	78	70	36	SCD631-0600-3-3-135HA12-HP358	31035377
6,10	8	146	108	94	36	SCD631-0610-3-3-135HA12-HP358	31035378
6,20	8	146	108	94	36	SCD631-0620-3-3-135HA12-HP358	31035379
6,50	8	146	108	94	36	SCD631-0650-3-3-135HA12-HP358	31035382
6,60	8	146	108	94	36	SCD631-0660-3-3-135HA12-HP358	31035383
6,80	8	146	108	94	36	SCD631-0680-3-3-135HA12-HP358	31035385
7,00	8	146	108	94	36	SCD631-0700-3-3-135HA12-HP358	31035387
7,50	8	146	108	94	36	SCD631-0750-3-3-135HA12-HP358	31035392
7,80	8	146	108	94	36	SCD631-0780-3-3-135HA12-HP358	31035395
8,00	8	146	108	94	36	SCD631-0800-3-3-135HA12-HP358	31035397
8,50	10	162	120	110	40	SCD631-0850-3-3-135HA12-HP358	31035402
9,00	10	162	120	110	40	SCD631-0900-3-3-135HA12-HP358	31035407
9,50	10	162	120	110	40	SCD631-0950-3-3-135HA12-HP358	31035412
9,80	10	162	120	110	40	SCD631-0980-3-3-135HA12-HP358	31035415
9,90	10	162	120	110	40	SCD631-0990-3-3-135HA12-HP358	31035416
10,00	10	162	120	110	40	SCD631-1000-3-3-135HA12-HP358	31035417
10,20	12	204	156	142	45	SCD631-1020-3-3-135HA12-HP358	31035419
10,50	12	204	156	142	45	SCD631-1050-3-3-135HA12-HP358	31035422
11,00	12	204	156	142	45	SCD631-1100-3-3-135HA12-HP358	31035427
11,30	12	204	156	142	45	SCD631-1130-3-3-135HA12-HP358	31035430
11,80	12	204	156	142	45	SCD631-1180-3-3-135HA12-HP358	31035435

Tritan-Drill-Uni-Plus | Wiertła spiralne z węgla spiekane SCD631 (12xD), wewnętrzne doprowadzenie chłodziwa

Wymiary						Typ chwytu HA	
d ₁ m7	d ₂ h6	l ₁	l ₂	l ₃	l ₄	Specyfikacja	Nr materiałowy
12,00	12	204	156	142	45	SCD631-1200-3-3-135HA12-HP358	31035437
12,50	14	230	182	166	45	SCD631-1250-3-3-135HA12-HP358	31035439
13,00	14	230	182	166	45	SCD631-1300-3-3-135HA12-HP358	31035441
13,50	14	230	182	166	45	SCD631-1350-3-3-135HA12-HP358	31035443
13,80	14	230	182	166	45	SCD631-1380-3-3-135HA12-HP358	31035444
14,00	14	230	182	166	45	SCD631-1400-3-3-135HA12-HP358	31035445
15,00	16	260	208	192	48	SCD631-1500-3-3-135HA12-HP358	31035449
15,80	16	260	208	192	48	SCD631-1580-3-3-135HA12-HP358	31035452
16,00	16	260	208	192	48	SCD631-1600-3-3-135HA12-HP358	31035453

Możliwość konfiguracji parametrów



Średnica:
możliwość wyboru średnicy w krokach
co 0,01 mm





Typ chwytu:
Typ chwytu: HB | HE

Specyfikacja:
SCD631-[średnica]-3-3-140[typ chwytu]12-HP358

Wymiary typoszeregu z możliwością konfiguracji parametrów

d ₁ min.	d ₁ max.	d ₂ h6	l ₁	l ₂	l ₃	l ₄
4,00	4,70	6	102	64	58	36
4,71	6,00	6	116	78	70	36
6,01	8,00	8	146	108	94	36
8,01	10,00	10	162	120	110	40
10,01	12,00	12	204	156	142	45
12,01	14,00	14	230	182	166	45
14,01	16,00	16	260	208	192	48
16,01	18,00	18	285	234	216	48
18,01	20,00	20	310	258	240	50

Przykład:

SCD631-0431-3-3-140HE12-HP358

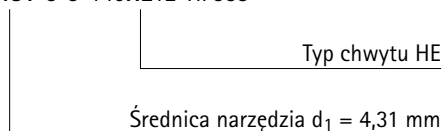

Wymiary podano w mm.

Zalecane parametry skrawania - patrz koniec rozdziału.

Wersje specjalne i inne powłoki wg zapytania ofertowego.

MEGA-Speed-Drill-Uni

Wiertła spiralne z węgla spiekane
SCD221 (3xD), wewnętrzne doprowadzenie chłodziwa

Wersja:

Średnica wiertła:	3,00 – 20,00 mm
Tolerancja otworu:	≥ IT 9
Materiał skrawający:	HP374
Liczba ostrzy:	2
Liczba tyśinek:	3
Kąt wierzchołkowy:	135°
Kąt spirali:	30°

Zastosowanie:

Do obróbki z dużą prędkością.

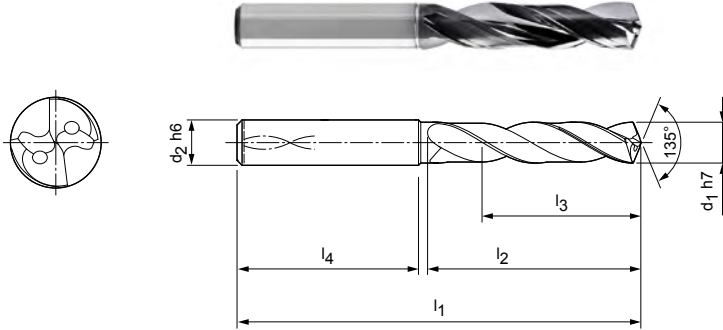

Magazynowa seria preferowana z typem chwytu HA

Wymiary						Typ chwytu HA	
d ₁ h7	d ₂ h6	l ₁	l ₂	l ₃	l ₄	Specyfikacja	Nr materiałowy
3,00	6	62	20	14	36	SCD221-0300-2-3-135HA03-HP374	30404127
3,10	6	62	20	14	36	SCD221-0310-2-3-135HA03-HP374	30404128
3,20	6	62	20	14	36	SCD221-0320-2-3-135HA03-HP374	30404129
3,30	6	62	20	14	36	SCD221-0330-2-3-135HA03-HP374	30404130
3,40	6	62	20	14	36	SCD221-0340-2-3-135HA03-HP374	30404131
3,50	6	62	20	14	36	SCD221-0350-2-3-135HA03-HP374	30404132
3,70	6	62	20	14	36	SCD221-0370-2-3-135HA03-HP374	30404134
4,00	6	66	24	17	36	SCD221-0400-2-3-135HA03-HP374	30404137
4,20	6	66	24	17	36	SCD221-0420-2-3-135HA03-HP374	30404139
4,30	6	66	24	17	36	SCD221-0430-2-3-135HA03-HP374	30404140
4,50	6	66	24	17	36	SCD221-0450-2-3-135HA03-HP374	30404142
5,00	6	66	28	20	36	SCD221-0500-2-3-135HA03-HP374	30404148
5,10	6	66	28	20	36	SCD221-0510-2-3-135HA03-HP374	30404149
5,20	6	66	28	20	36	SCD221-0520-2-3-135HA03-HP374	30404150
5,50	6	66	28	20	36	SCD221-0550-2-3-135HA03-HP374	30404153
5,55	6	66	28	20	36	SCD221-0555-2-3-135HA03-HP374	30404154
5,60	6	66	28	20	36	SCD221-0560-2-3-135HA03-HP374	30404155
5,80	6	66	28	20	36	SCD221-0580-2-3-135HA03-HP374	30404157
6,00	6	66	28	20	36	SCD221-0600-2-3-135HA03-HP374	30404159
6,30	8	79	34	24	36	SCD221-0630-2-3-135HA03-HP374	30404162
6,50	8	79	34	24	36	SCD221-0650-2-3-135HA03-HP374	30404164
6,80	8	79	34	24	36	SCD221-0680-2-3-135HA03-HP374	30404167
6,90	8	79	34	24	36	SCD221-0690-2-3-135HA03-HP374	30404168
7,00	8	79	34	24	36	SCD221-0700-2-3-135HA03-HP374	30404169
7,40	8	79	41	29	36	SCD221-0740-2-3-135HA03-HP374	30404173
7,50	8	79	41	29	36	SCD221-0750-2-3-135HA03-HP374	30404175
7,80	8	79	41	29	36	SCD221-0780-2-3-135HA03-HP374	30404178
8,00	8	79	41	29	36	SCD221-0800-2-3-135HA03-HP374	30404180
8,50	10	89	47	35	40	SCD221-0850-2-3-135HA03-HP374	30404185
8,60	10	89	47	35	40	SCD221-0860-2-3-135HA03-HP374	30404186
8,80	10	89	47	35	40	SCD221-0880-2-3-135HA03-HP374	30404188
9,00	10	89	47	35	40	SCD221-0900-2-3-135HA03-HP374	30404190
9,50	10	89	47	35	40	SCD221-0950-2-3-135HA03-HP374	30404195
9,80	10	89	47	35	40	SCD221-0980-2-3-135HA03-HP374	30404198
9,90	10	89	47	35	40	SCD221-0990-2-3-135HA03-HP374	30404199

MEGA-Speed-Drill-Uni | Wiertła spiralne z węgla spiekane SCD221 (3xD), wewnętrzne doprowadzenie chłodziwa

Wymiary						Typ chwytu HA	
d ₁ h7	d ₂ h6	l ₁	l ₂	l ₃	l ₄	Specyfikacja	Nr materiałowy
10,00	10	89	47	35	40	SCD221-1000-2-3-135HA03-HP374	30404200
10,20	12	102	55	40	45	SCD221-1020-2-3-135HA03-HP374	30404202
10,30	12	102	55	40	45	SCD221-1030-2-3-135HA03-HP374	30404203
10,50	12	102	55	40	45	SCD221-1050-2-3-135HA03-HP374	30404205
10,60	12	102	55	40	45	SCD221-1060-2-3-135HA03-HP374	30404206
11,00	12	102	55	40	45	SCD221-1100-2-3-135HA03-HP374	30404210
11,50	12	102	55	40	45	SCD221-1150-2-3-135HA03-HP374	30404215
11,60	12	102	55	40	45	SCD221-1160-2-3-135HA03-HP374	30404216
11,80	12	102	55	40	45	SCD221-1180-2-3-135HA03-HP374	30404219
12,00	12	102	55	40	45	SCD221-1200-2-3-135HA03-HP374	30404221
12,50	14	107	60	43	45	SCD221-1250-2-3-135HA03-HP374	30404222
13,00	14	107	60	43	45	SCD221-1300-2-3-135HA03-HP374	30404224
13,50	14	107	60	43	45	SCD221-1350-2-3-135HA03-HP374	30404225
14,00	14	107	60	43	45	SCD221-1400-2-3-135HA03-HP374	30404227
14,50	16	115	65	45	48	SCD221-1450-2-3-135HA03-HP374	30404228
15,00	16	115	65	45	48	SCD221-1500-2-3-135HA03-HP374	30404230
16,00	16	115	65	45	48	SCD221-1600-2-3-135HA03-HP374	30404233
17,00	18	123	73	51	48	SCD221-1700-2-3-135HA03-HP374	30404236
17,50	18	123	73	51	48	SCD221-1750-2-3-135HA03-HP374	30404237
17,80	18	123	73	51	48	SCD221-1780-2-3-135HA03-HP374	30404238
18,00	18	123	73	51	48	SCD221-1800-2-3-135HA03-HP374	30404239
18,50	20	131	79	55	50	SCD221-1850-2-3-135HA03-HP374	30404240
19,50	20	131	79	55	50	SCD221-1950-2-3-135HA03-HP374	30404243
20,00	20	131	79	55	50	SCD221-2000-2-3-135HA03-HP374	30404245

Możliwość konfiguracji parametrów



Średnica:
możliwość wyboru średnicy w krokach
co 0,01 mm





Typ chwytu:
Typ chwytu: HB | HE

Specyfikacja:
SCD221-[średnica]-3-3-140[typ chwytu]03-HP358

Wymiary typoszeregu z możliwością konfiguracji parametrów

d ₁ min.	d ₁ max.	d ₂ h6	l ₁	l ₂	l ₃	l ₄
3,00	3,70	6	62	20	14	36
3,71	4,70	6	66	24	17	36
4,71	6,00	6	66	28	20	36
6,01	8,00	8	79	34	24	36
8,01	10,00	10	89	47	35	40
10,01	12,00	12	102	55	40	45
12,01	14,00	14	107	60	43	45
14,01	16,00	16	115	65	45	48
16,01	18,00	18	123	73	51	48
18,01	20,00	20	131	79	55	50

Przykład:

SCD221-0431-3-3-140HE03-HP358

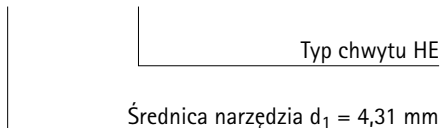

Wymiary podano w mm.

Zalecane parametry skrawania - patrz koniec rozdziału.

Wersje specjalne i inne powłoki wg zapytania ofertowego.

MEGA-Speed-Drill-Uni

Wiertła spiralne z węgla spiekane
SCD221 (5xD), wewnętrzne doprowadzenie chłodziwa

Wersja:

Średnica wiertła:	3,00 – 20,00 mm
Tolerancja otworu:	≥ IT 9
Materiał skrawający:	HP374
Liczba ostrzy:	2
Liczba tyśnek:	3
Kąt wierzchołkowy:	135°
Kąt spirali:	30°

Zastosowanie:

Do obróbki z dużą prędkością.

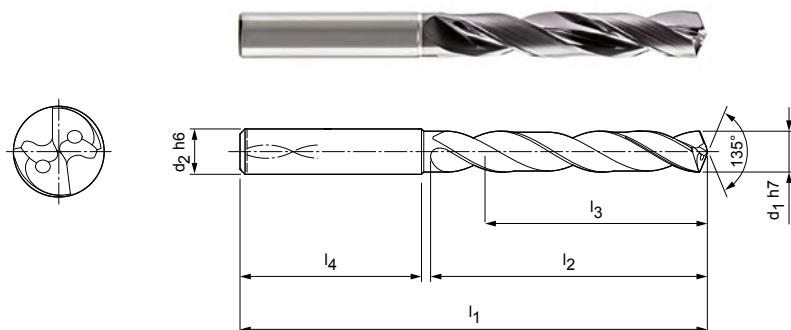

Magazynowa seria preferowana z typem chwytu HA

Wymiary						Typ chwytu HA	
d ₁ h7	d ₂ h6	l ₁	l ₂	l ₃	l ₄	Specyfikacja	Nr materiałowy
3,00	6	66	28	23	36	SCD221-0300-2-3-135HA05-HP374	30392925
3,10	6	66	28	23	36	SCD221-0310-2-3-135HA05-HP374	30392926
3,20	6	66	28	23	36	SCD221-0320-2-3-135HA05-HP374	30392927
3,30	6	66	28	23	36	SCD221-0330-2-3-135HA05-HP374	30392928
3,40	6	66	28	23	36	SCD221-0340-2-3-135HA05-HP374	30392929
3,50	6	66	28	23	36	SCD221-0350-2-3-135HA05-HP374	30392930
3,70	6	66	28	23	36	SCD221-0370-2-3-135HA05-HP374	30392932
4,00	6	74	36	29	36	SCD221-0400-2-3-135HA05-HP374	30392935
4,20	6	74	36	29	36	SCD221-0420-2-3-135HA05-HP374	30392937
4,30	6	74	36	29	36	SCD221-0430-2-3-135HA05-HP374	30392938
4,50	6	74	36	29	36	SCD221-0450-2-3-135HA05-HP374	30392940
5,00	6	82	44	35	36	SCD221-0500-2-3-135HA05-HP374	30392946
5,10	6	82	44	35	36	SCD221-0510-2-3-135HA05-HP374	30392947
5,20	6	82	44	35	36	SCD221-0520-2-3-135HA05-HP374	30392948
5,50	6	82	44	35	36	SCD221-0550-2-3-135HA05-HP374	30392951
5,60	6	82	44	35	36	SCD221-0560-2-3-135HA05-HP374	30392953
5,80	6	82	44	35	36	SCD221-0580-2-3-135HA05-HP374	30392955
6,00	6	82	44	35	36	SCD221-0600-2-3-135HA05-HP374	30392957
6,50	8	91	53	43	36	SCD221-0650-2-3-135HA05-HP374	30392962
6,60	8	91	53	43	36	SCD221-0660-2-3-135HA05-HP374	30392963
6,80	8	91	53	43	36	SCD221-0680-2-3-135HA05-HP374	30392965
6,90	8	91	53	43	36	SCD221-0690-2-3-135HA05-HP374	30392966
7,00	8	91	53	43	36	SCD221-0700-2-3-135HA05-HP374	30392967
7,40	8	91	53	43	36	SCD221-0740-2-3-135HA05-HP374	30392971
7,50	8	91	53	43	36	SCD221-0750-2-3-135HA05-HP374	30392972
7,80	8	91	53	43	36	SCD221-0780-2-3-135HA05-HP374	30392975
8,00	8	91	53	43	36	SCD221-0800-2-3-135HA05-HP374	30392977
8,50	10	103	61	49	40	SCD221-0850-2-3-135HA05-HP374	30392982
8,60	10	103	61	49	40	SCD221-0860-2-3-135HA05-HP374	30392983
8,80	10	103	61	49	40	SCD221-0880-2-3-135HA05-HP374	30392985
9,00	10	103	61	49	40	SCD221-0900-2-3-135HA05-HP374	30392987
9,50	10	103	61	49	40	SCD221-0950-2-3-135HA05-HP374	30392992
9,70	10	103	61	49	40	SCD221-0970-2-3-135HA05-HP374	30392994
9,80	10	103	61	49	40	SCD221-0980-2-3-135HA05-HP374	30392995
10,00	10	103	61	49	40	SCD221-1000-2-3-135HA05-HP374	30392997

MEGA-Speed-Drill-Uni | Wiertła spiralne z węglika spiekanego SCD221 (5xD), wewnętrzne doprowadzenie chłodziwa

Wymiary						Typ chwytu HA	
d ₁ h7	d ₂ h6	l ₁	l ₂	l ₃	l ₄	Specyfikacja	Nr materiałowy
10,20	12	118	71	56	45	SCD221-1020-2-3-135HA05-HP374	30392999
10,30	12	118	71	56	45	SCD221-1030-2-3-135HA05-HP374	30393000
10,50	12	118	71	56	45	SCD221-1050-2-3-135HA05-HP374	30393002
11,00	12	118	71	56	45	SCD221-1100-2-3-135HA05-HP374	30393007
11,50	12	118	71	56	45	SCD221-1150-2-3-135HA05-HP374	30393012
11,80	12	118	71	56	45	SCD221-1180-2-3-135HA05-HP374	30393015
12,00	12	118	71	56	45	SCD221-1200-2-3-135HA05-HP374	30393017
12,50	14	124	77	60	45	SCD221-1250-2-3-135HA05-HP374	30393018
13,00	14	124	77	60	45	SCD221-1300-2-3-135HA05-HP374	30393020
13,50	14	124	77	60	45	SCD221-1350-2-3-135HA05-HP374	30393021
13,80	14	124	77	60	45	SCD221-1380-2-3-135HA05-HP374	30393022
14,00	14	124	77	60	45	SCD221-1400-2-3-135HA05-HP374	30393023
14,50	16	133	83	63	48	SCD221-1450-2-3-135HA05-HP374	30393024
15,00	16	133	83	63	48	SCD221-1500-2-3-135HA05-HP374	30393026
15,50	16	133	83	63	48	SCD221-1550-2-3-135HA05-HP374	30393027
15,80	16	133	83	63	48	SCD221-1580-2-3-135HA05-HP374	30393028
16,00	16	133	83	63	48	SCD221-1600-2-3-135HA05-HP374	30393029
16,80	18	143	93	71	48	SCD221-1680-2-3-135HA05-HP374	30393031
17,00	18	143	93	71	48	SCD221-1700-2-3-135HA05-HP374	30393032
17,50	18	143	93	71	48	SCD221-1750-2-3-135HA05-HP374	30393033
17,80	18	143	93	71	48	SCD221-1780-2-3-135HA05-HP374	30393034
18,00	18	143	93	71	48	SCD221-1800-2-3-135HA05-HP374	30393035
18,50	20	153	101	77	50	SCD221-1850-2-3-135HA05-HP374	30393036
18,80	20	153	101	77	50	SCD221-1880-2-3-135HA05-HP374	30393037
19,00	20	153	101	77	50	SCD221-1900-2-3-135HA05-HP374	30393038
20,00	20	153	101	77	50	SCD221-2000-2-3-135HA05-HP374	30393041

Możliwość konfiguracji parametrów



Średnica:
możliwość wyboru średnicy w krokach
co 0,01 mm





Typ chwytu:
Typ chwytu: HB | HE

Specyfikacja:
SCD221-[średnica]-3-3-140[typ chwytu]05-HP358

Wymiary typoszeregu z możliwością konfiguracji parametrów

d ₁ min.	d ₁ max.	d ₂ h6	l ₁	l ₂	l ₃	l ₄
3,00	3,70	6	66	28	23	36
3,71	4,70	6	74		29	36
4,71	6,00	6	82	44	35	36
6,01	8,00	8	91	53	43	36
8,01	10,00	10	103	61	49	40
10,01	12,00	12	118	71	56	45
12,01	14,00	14	124	77	60	45
14,01	16,00	16	133	83	63	48
16,01	18,00	18	143	93	71	48
18,01	20,00	20	153	101	77	50

Przykład:

SCD221-0431-3-3-140HE05-HP374

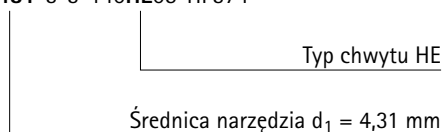

Wymiary podano w mm.

Zalecane parametry skrawania - patrz koniec rozdziału.

Wersje specjalne i inne powłoki wg zapytania ofertowego.

MEGA-Speed-Drill-Uni

Wiertła spiralne z węgla spiekane
SCD221 (8xD), wewnętrzne doprowadzenie chłodziwa

Wersja:

Średnica wiertła: 3,00 – 20,00 mm
Tolerancja otworu: \geq IT 9
Materiał skrawający: HP374
Liczba ostrzy: 2
Liczba tyśinek: 3
Kąt wierzchołkowy: 135°
Kąt spirali: 30°

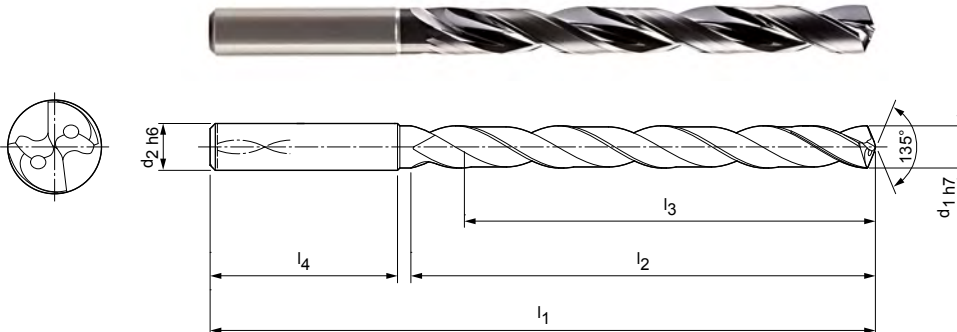

Zastosowanie:

Do obróbki z dużą prędkością.

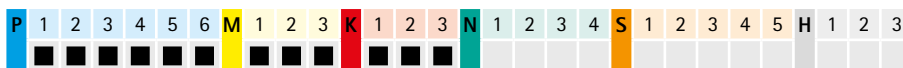

Magazynowa seria preferowana z typem chwytu HA

Wymiary						Typ chwytu HA	
d ₁ h7	d ₂ h6	l ₁	l ₂	l ₃	l ₄	Specyfikacja	Nr materiałowy
3,00	6	72	34	29	36	SCD221-0300-2-3-135HA08-HP374	30404000
3,20	6	72	34	29	36	SCD221-0320-2-3-135HA08-HP374	30404002
3,30	6	72	34	29	36	SCD221-0330-2-3-135HA08-HP374	30404003
3,40	6	72	34	29	36	SCD221-0340-2-3-135HA08-HP374	30404004
3,50	6	72	34	29	36	SCD221-0350-2-3-135HA08-HP374	30404005
3,70	6	72	34	29	36	SCD221-0370-2-3-135HA08-HP374	30404007
4,00	6	81	43	36	36	SCD221-0400-2-3-135HA08-HP374	30404010
4,10	6	81	43	36	36	SCD221-0410-2-3-135HA08-HP374	30404011
4,20	6	81	43	36	36	SCD221-0420-2-3-135HA08-HP374	30404012
4,30	6	81	43	36	36	SCD221-0430-2-3-135HA08-HP374	30404013
4,50	6	81	43	36	36	SCD221-0450-2-3-135HA08-HP374	30404015
4,80	6	95	57	48	36	SCD221-0480-2-3-135HA08-HP374	30404019
5,00	6	95	57	48	36	SCD221-0500-2-3-135HA08-HP374	30404021
5,10	6	95	57	48	36	SCD221-0510-2-3-135HA08-HP374	30404022
5,20	6	95	57	48	36	SCD221-0520-2-3-135HA08-HP374	30404023
5,40	6	95	57	48	36	SCD221-0540-2-3-135HA08-HP374	30404025
5,50	6	95	57	48	36	SCD221-0550-2-3-135HA08-HP374	30404026
5,80	6	95	57	48	36	SCD221-0580-2-3-135HA08-HP374	30404030
6,00	6	95	57	48	36	SCD221-0600-2-3-135HA08-HP374	30404032
6,10	8	114	76	64	36	SCD221-0610-2-3-135HA08-HP374	30404033
6,40	8	114	76	64	36	SCD221-0640-2-3-135HA08-HP374	30404036
6,50	8	114	76	64	36	SCD221-0650-2-3-135HA08-HP374	30404037
6,80	8	114	76	64	36	SCD221-0680-2-3-135HA08-HP374	30404040
7,00	8	114	76	64	36	SCD221-0700-2-3-135HA08-HP374	30404043
7,50	8	114	76	64	36	SCD221-0750-2-3-135HA08-HP374	30404048
7,80	8	114	76	64	36	SCD221-0780-2-3-135HA08-HP374	30404051
8,00	8	114	76	64	36	SCD221-0800-2-3-135HA08-HP374	30404053
8,50	10	142	95	80	40	SCD221-0850-2-3-135HA08-HP374	30404058
9,00	10	142	95	80	40	SCD221-0900-2-3-135HA08-HP374	30404063
9,30	10	142	95	80	40	SCD221-0930-2-3-135HA08-HP374	30404066
9,50	10	142	95	80	40	SCD221-0950-2-3-135HA08-HP374	30404068
9,60	10	142	95	80	40	SCD221-0960-2-3-135HA08-HP374	30404069
9,80	10	142	95	80	40	SCD221-0980-2-3-135HA08-HP374	30404071
10,00	10	142	95	80	40	SCD221-1000-2-3-135HA08-HP374	30404073
10,20	12	162	114	96	45	SCD221-1020-2-3-135HA08-HP374	30404075

MEGA-Speed-Drill-Uni | Wiertła spiralne z węgla spiekane SCD221 (8xD), wewnętrzne doprowadzenie chłodziwa

Wymiary						Typ chwytu HA	
d ₁ h7	d ₂ h6	l ₁	l ₂	l ₃	l ₄	Specyfikacja	Nr materiałowy
10,50	12	162	114	96	45	SCD221-1050-2-3-135HA08-HP374	30404078
11,00	12	162	114	96	45	SCD221-1100-2-3-135HA08-HP374	30404083
11,40	12	162	114	96	45	SCD221-1140-2-3-135HA08-HP374	30404088
11,80	12	162	114	96	45	SCD221-1180-2-3-135HA08-HP374	30404092
12,00	12	162	114	96	45	SCD221-1200-2-3-135HA08-HP374	30404094
12,50	14	178	133	112	45	SCD221-1250-2-3-135HA08-HP374	30404095
13,00	14	178	133	112	45	SCD221-1300-2-3-135HA08-HP374	30404097
13,50	14	178	133	112	45	SCD221-1350-2-3-135HA08-HP374	30404098
14,00	14	178	133	112	45	SCD221-1400-2-3-135HA08-HP374	30404100
15,00	16	203	152	128	48	SCD221-1500-2-3-135HA08-HP374	30404103
16,00	16	203	152	128	48	SCD221-1600-2-3-135HA08-HP374	30404106
17,50	18	222	171	144	48	SCD221-1750-2-3-135HA08-HP374	30404110

Możliwość konfiguracji parametrów



Średnica:
możliwość wyboru średnicy w
krokach co 0,01 mm





Typ chwytu:
Typ chwytu: HB | HE

Specyfikacja:
SCD221-[średnica]-3-3-140[typ chwytu]08-HP374

Wymiary typoszeregu z możliwością konfiguracji parametrów

d ₁ min.	d ₁ max.	d ₂ h6	l ₁	l ₂	l ₃	l ₄
3,00	3,70	6	72	34	29	36
3,71	4,70	6	81	43	36	36
4,80	6,00	6	95	57	48	36
6,01	8,00	8	114	76	64	36
8,01	10,00	10	142	95	80	40
10,01	12,00	12	162	114	96	45
12,01	14,00	14	178	133	112	45
14,01	16,00	16	203	152	128	48
16,01	18,00	18	222	171	144	48
18,01	20,00	20	243	190	160	50

Przykład:

SCD221-0431-3-3-140HE08-HP374

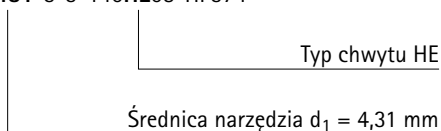

Wymiary podano w mm.

Zalecane parametry skrawania - patrz koniec rozdziału.

Wersje specjalne i inne powłoki wg zapytania ofertowego.

ECU-Drill-Uni

Wiertła spiralne z węgla spiekane
SCD351 (4xD), wewnętrzne doprowadzenie chłodziwa

Wersja:

Średnica wiertła: 3,00 - 20,00 mm
Tolerancja otworu: \geq IT 9
Materiał skrawający: HP765
Liczba ostrzy: 2
Kąt wierzchołkowy: 140°
Kąt spirali: 30°

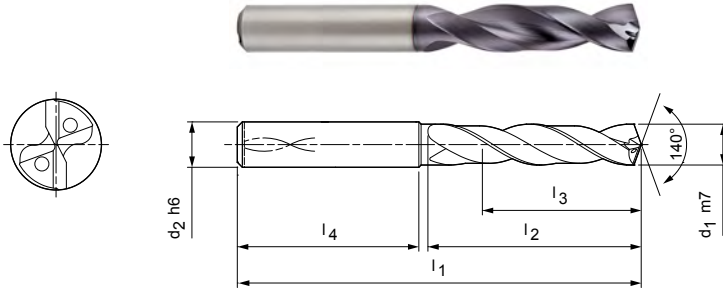

Magazynowa seria preferowana z typem chwytu HA

Wymiary						Typ chwytu HA	
d ₁ m7	d ₂ h6	l ₁	l ₂	l ₃	l ₄	Specyfikacja	Nr materiałowy
3,00	6	62	22	16	36	SCD351-0300-2-2-140HA04-HP765	30421828
3,10	6	62	22	16	36	SCD351-0310-2-2-140HA04-HP765	30421829
3,20	6	62	22	16	36	SCD351-0320-2-2-140HA04-HP765	30421830
3,30	6	62	22	16	36	SCD351-0330-2-2-140HA04-HP765	30421831
3,40	6	62	22	16	36	SCD351-0340-2-2-140HA04-HP765	30421832
3,50	6	62	22	16	36	SCD351-0350-2-2-140HA04-HP765	30421833
3,60	6	62	22	16	36	SCD351-0360-2-2-140HA04-HP765	30421834
3,70*	6	62	22	16	36	SCD351-0370-2-2-140HA04-HP765	30421835
3,80	6	66	26	22	36	SCD351-0380-2-2-140HA04-HP765	30421836
3,90	6	66	26	22	36	SCD351-0390-2-2-140HA04-HP765	30421837
4,00	6	66	26	22	36	SCD351-0400-2-2-140HA04-HP765	30421838
4,10	6	66	26	22	36	SCD351-0410-2-2-140HA04-HP765	30421839
4,20	6	66	26	22	36	SCD351-0420-2-2-140HA04-HP765	30421840
4,30	6	66	26	22	36	SCD351-0430-2-2-140HA04-HP765	30421842
4,40	6	66	26	22	36	SCD351-0440-2-2-140HA04-HP765	30421843
4,50	6	66	26	22	36	SCD351-0450-2-2-140HA04-HP765	30421844
4,60	6	66	26	22	36	SCD351-0460-2-2-140HA04-HP765	30421845
4,65*	6	66	26	22	36	SCD351-0465-2-2-140HA04-HP765	30421846
4,70	6	66	26	22	36	SCD351-0470-2-2-140HA04-HP765	30421847
4,80	6	66	30	24	36	SCD351-0480-2-2-140HA04-HP765	30421848
4,90	6	66	30	24	36	SCD351-0490-2-2-140HA04-HP765	30421849
5,00	6	66	30	24	36	SCD351-0500-2-2-140HA04-HP765	30421850
5,10	6	66	30	24	36	SCD351-0510-2-2-140HA04-HP765	30421851
5,20	6	66	30	24	36	SCD351-0520-2-2-140HA04-HP765	30421852
5,30	6	66	30	24	36	SCD351-0530-2-2-140HA04-HP765	30421853
5,40	6	66	30	24	36	SCD351-0540-2-2-140HA04-HP765	30421854
5,50	6	66	30	24	36	SCD351-0550-2-2-140HA04-HP765	30421855
5,55*	6	66	30	24	36	SCD351-0555-2-2-140HA04-HP765	30421856
5,60	6	66	30	24	36	SCD351-0560-2-2-140HA04-HP765	30421857
5,70	6	66	30	24	36	SCD351-0570-2-2-140HA04-HP765	30421858
5,80	6	66	30	24	36	SCD351-0580-2-2-140HA04-HP765	30421859
5,90	6	66	30	24	36	SCD351-0590-2-2-140HA04-HP765	30421860
6,00	6	66	30	24	36	SCD351-0600-2-2-140HA04-HP765	30421861
6,10	8	79	38	30	36	SCD351-0610-2-2-140HA04-HP765	30421862

ECU-Drill-Uni | Wiertła spiralne z węgla spiekanego SCD351 (4xD), wewnętrzne doprowadzenie chłodziwa

Wymiary						Typ chwytu HA	
d ₁ m7	d ₂ h6	l ₁	l ₂	l ₃	l ₄	Specyfikacja	Nr materiałowy
6,20	8	79	38	30	36	SCD351-0620-2-2-140HA04-HP765	30421863
6,30	8	79	38	30	36	SCD351-0630-2-2-140HA04-HP765	30421864
6,40	8	79	38	30	36	SCD351-0640-2-2-140HA04-HP765	30421865
6,50	8	79	38	30	36	SCD351-0650-2-2-140HA04-HP765	30421866
6,60	8	79	38	30	36	SCD351-0660-2-2-140HA04-HP765	30421867
6,70	8	79	38	30	36	SCD351-0670-2-2-140HA04-HP765	30421868
6,80	8	79	38	30	36	SCD351-0680-2-2-140HA04-HP765	30421869
6,90	8	79	38	30	36	SCD351-0690-2-2-140HA04-HP765	30421870
7,00	8	79	38	30	36	SCD351-0700-2-2-140HA04-HP765	30421871
7,10	8	79	42	34	36	SCD351-0710-2-2-140HA04-HP765	30421872
7,20	8	79	42	34	36	SCD351-0720-2-2-140HA04-HP765	30421873
7,30	8	79	42	34	36	SCD351-0730-2-2-140HA04-HP765	30421874
7,40	8	79	42	34	36	SCD351-0740-2-2-140HA04-HP765	30421875
7,45*	8	79	42	34	36	SCD351-0745-2-2-140HA04-HP765	30569196
7,50	8	79	42	34	36	SCD351-0750-2-2-140HA04-HP765	30421876
7,60	8	79	42	34	36	SCD351-0760-2-2-140HA04-HP765	30421878
7,70	8	79	42	34	36	SCD351-0770-2-2-140HA04-HP765	30421879
7,80	8	79	42	34	36	SCD351-0780-2-2-140HA04-HP765	30421880
7,90	8	79	42	34	36	SCD351-0790-2-2-140HA04-HP765	30421881
8,00	8	79	42	34	36	SCD351-0800-2-2-140HA04-HP765	30421882
8,10	10	89	49	38	40	SCD351-0810-2-2-140HA04-HP765	30421883
8,20	10	89	49	38	40	SCD351-0820-2-2-140HA04-HP765	30421884
8,30	10	89	49	38	40	SCD351-0830-2-2-140HA04-HP765	30421885
8,40	10	89	49	38	40	SCD351-0840-2-2-140HA04-HP765	30421886
8,50	10	89	49	38	40	SCD351-0850-2-2-140HA04-HP765	30421887
8,60	10	89	49	38	40	SCD351-0860-2-2-140HA04-HP765	30421888
8,70	10	89	49	38	40	SCD351-0870-2-2-140HA04-HP765	30421889
8,80	10	89	49	38	40	SCD351-0880-2-2-140HA04-HP765	30421890
8,90	10	89	49	38	40	SCD351-0890-2-2-140HA04-HP765	30421891
9,00	10	89	49	38	40	SCD351-0900-2-2-140HA04-HP765	30421892
9,10	10	89	49	38	40	SCD351-0910-2-2-140HA04-HP765	30421893
9,20	10	89	49	38	40	SCD351-0920-2-2-140HA04-HP765	30421894
9,30*	10	89	49	40	40	SCD351-0930-2-2-140HA04-HP765	30421896
9,40	10	89	49	40	40	SCD351-0940-2-2-140HA04-HP765	30421897
9,50	10	89	49	40	40	SCD351-0950-2-2-140HA04-HP765	30421898
9,60	10	89	49	40	40	SCD351-0960-2-2-140HA04-HP765	30421899
9,70	10	89	49	40	40	SCD351-0970-2-2-140HA04-HP765	30421900
9,80	10	89	49	40	40	SCD351-0980-2-2-140HA04-HP765	30421901
9,90	10	89	49	40	40	SCD351-0990-2-2-140HA04-HP765	30421902
10,00	10	89	49	40	40	SCD351-1000-2-2-140HA04-HP765	30421903
10,10	12	102	56	45	45	SCD351-1010-2-2-140HA04-HP765	30421904
10,20	12	102	56	45	45	SCD351-1020-2-2-140HA04-HP765	30421905
10,30	12	102	56	45	45	SCD351-1030-2-2-140HA04-HP765	30421906
10,40	12	102	56	45	45	SCD351-1040-2-2-140HA04-HP765	30421907
10,50	12	102	56	45	45	SCD351-1050-2-2-140HA04-HP765	30421908
10,60	12	102	56	45	45	SCD351-1060-2-2-140HA04-HP765	30421909
10,70	12	102	56	45	45	SCD351-1070-2-2-140HA04-HP765	30421910
10,80	12	102	56	45	45	SCD351-1080-2-2-140HA04-HP765	30421911
10,90	12	102	56	45	45	SCD351-1090-2-2-140HA04-HP765	30421912
11,00	12	102	56	45	45	SCD351-1100-2-2-140HA04-HP765	30421913
11,10	12	102	56	45	45	SCD351-1110-2-2-140HA04-HP765	30421914
11,20*	12	102	56	45	45	SCD351-1120-2-2-140HA04-HP765	30421915
11,50	12	102	56	45	45	SCD351-1150-2-2-140HA04-HP765	30421918
11,70	12	102	56	45	45	SCD351-1170-2-2-140HA04-HP765	30421920
11,80	12	102	56	45	45	SCD351-1180-2-2-140HA04-HP765	30421921

Ciąg dalszy na następnej stronie.

ECU-Drill-Uni | Wiertła spiralne z węgla spiekanego SCD351 (4xD), wewnętrzne doprowadzenie chłodziwa

Wymiary						Typ chwytu HA	
d ₁ m7	d ₂ h6	l ₁	l ₂	l ₃	l ₄	Specyfikacja	Nr materiałowy
11,90	12	102	56	45	45	SCD351-1190-2-2-140HA04-HP765	30421922
12,00	12	102	56	45	45	SCD351-1200-2-2-140HA04-HP765	30421923
12,20	14	107	61	50	45	SCD351-1220-2-2-140HA04-HP765	30421924
12,50	14	107	61	50	45	SCD351-1250-2-2-140HA04-HP765	30421925
12,70	14	107	61	50	45	SCD351-1270-2-2-140HA04-HP765	30421926
12,80	14	107	61	50	45	SCD351-1280-2-2-140HA04-HP765	30421927
13,00	14	107	61	50	45	SCD351-1300-2-2-140HA04-HP765	30421928
13,50	14	107	61	50	45	SCD351-1350-2-2-140HA04-HP765	30421929
13,80	14	107	61	50	45	SCD351-1380-2-2-140HA04-HP765	30421931
14,00	14	107	61	50	45	SCD351-1400-2-2-140HA04-HP765	30421932
14,20	16	115	65	51	48	SCD351-1420-2-2-140HA04-HP765	30421934
14,50	16	115	65	51	48	SCD351-1450-2-2-140HA04-HP765	30421935
14,80	16	115	65	51	48	SCD351-1480-2-2-140HA04-HP765	30421936
15,00	16	115	65	51	48	SCD351-1500-2-2-140HA04-HP765	30421937
15,10	16	115	65	51	48	SCD351-1510-2-2-140HA04-HP765	30421938
15,20	16	115	65	51	48	SCD351-1520-2-2-140HA04-HP765	30421939
15,50	16	115	65	51	48	SCD351-1550-2-2-140HA04-HP765	30421941
15,70	16	115	65	51	48	SCD351-1570-2-2-140HA04-HP765	30421942
15,80	16	115	65	51	48	SCD351-1580-2-2-140HA04-HP765	30421943
16,00	16	115	65	51	48	SCD351-1600-2-2-140HA04-HP765	30421944
16,50	18	123	73	53	48	SCD351-1650-2-2-140HA04-HP765	30421946
16,80	18	123	73	53	48	SCD351-1680-2-2-140HA04-HP765	30569199
17,00	18	123	73	53	48	SCD351-1700-2-2-140HA04-HP765	30421947
17,30	18	123	73	53	48	SCD351-1730-2-2-140HA04-HP765	30421949
17,50	18	123	73	53	48	SCD351-1750-2-2-140HA04-HP765	30421950
17,70	18	123	73	53	48	SCD351-1770-2-2-140HA04-HP765	30421951
18,00	18	123	73	53	48	SCD351-1800-2-2-140HA04-HP765	30421952
18,50	20	131	79	55	50	SCD351-1850-2-2-140HA04-HP765	30421953
19,00	20	131	79	55	50	SCD351-1900-2-2-140HA04-HP765	30421954
19,50	20	131	79	55	50	SCD351-1950-2-2-140HA04-HP765	30421956
20,00	20	131	79	55	50	SCD351-2000-2-2-140HA04-HP765	30421957

Możliwość konfiguracji parametrów



Typ chwytu:
Typ chwytu: HB | HE



Specyfikacja:
SCD351-0430-3-3-140[typ chwytu]04-HP765

Przykład:

SCD351-0430-3-3-140HE04-HP765

Typ chwytu HE

Wymiary podano w mm.

*Nadaje się w szczególności do wiercenia otworów pod gwinty wykonywanych gniotownikami.

Zalecane parametry skrawania - patrz koniec rozdziału.

Wersje specjalne i inne powłoki wg zapytania ofertowego.

ECU-Drill-Uni

Wiertła spiralne z węgla spiekane
SCD350 (4xD), zewnętrzne doprowadzenie chłodziwa

Wersja:
Średnica wiertła: 3,00 - 20,00 mm
Tolerancja otworu: ≥ IT 9
Materiał skrawający: HP765
Liczba ostrzy: 2
Kąt wierzchołkowy: 140°
Kąt spirali: 30°

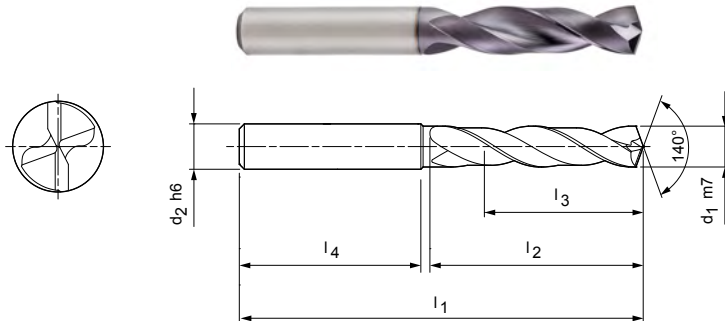

Magazynowa seria preferowana z typem chwytu HA

Wymiary						Typ chwytu HA	
d ₁ m7	d ₂ h6	l ₁	l ₂	l ₃	l ₄	Specyfikacja	Nr materiałowy
3,00	6	62	22	16	36	SCD350-0300-2-2-140HA04-HP765	30421694
3,10	6	62	22	16	36	SCD350-0310-2-2-140HA04-HP765	30421696
3,20	6	62	22	16	36	SCD350-0320-2-2-140HA04-HP765	30421697
3,30	6	62	22	16	36	SCD350-0330-2-2-140HA04-HP765	30421698
3,40	6	62	22	16	36	SCD350-0340-2-2-140HA04-HP765	30421699
3,50	6	62	22	16	36	SCD350-0350-2-2-140HA04-HP765	30421700
3,60	6	62	22	16	36	SCD350-0360-2-2-140HA04-HP765	30421701
3,70*	6	62	22	16	36	SCD350-0370-2-2-140HA04-HP765	30421703
3,80	6	66	26	22	36	SCD350-0380-2-2-140HA04-HP765	30421704
3,90	6	66	26	22	36	SCD350-0390-2-2-140HA04-HP765	30421705
4,00	6	66	26	22	36	SCD350-0400-2-2-140HA04-HP765	30421706
4,10	6	66	26	22	36	SCD350-0410-2-2-140HA04-HP765	30421707
4,20	6	66	26	22	36	SCD350-0420-2-2-140HA04-HP765	30421708
4,30	6	66	26	22	36	SCD350-0430-2-2-140HA04-HP765	30421709
4,40	6	66	26	22	36	SCD350-0440-2-2-140HA04-HP765	30421710
4,50	6	66	26	22	36	SCD350-0450-2-2-140HA04-HP765	30421711
4,60	6	66	26	22	36	SCD350-0460-2-2-140HA04-HP765	30421712
4,65*	6	66	26	22	36	SCD350-0465-2-2-140HA04-HP765	30421713
4,70	6	66	26	22	36	SCD350-0470-2-2-140HA04-HP765	30421714
4,80	6	66	30	24	36	SCD350-0480-2-2-140HA04-HP765	30421715
4,90	6	66	30	24	36	SCD350-0490-2-2-140HA04-HP765	30421716
5,00	6	66	30	24	36	SCD350-0500-2-2-140HA04-HP765	30421717
5,10	6	66	30	24	36	SCD350-0510-2-2-140HA04-HP765	30421718
5,20	6	66	30	24	36	SCD350-0520-2-2-140HA04-HP765	30421719
5,30	6	66	30	24	36	SCD350-0530-2-2-140HA04-HP765	30421720
5,40	6	66	30	24	36	SCD350-0540-2-2-140HA04-HP765	30421721
5,50	6	66	30	24	36	SCD350-0550-2-2-140HA04-HP765	30421722
5,55*	6	66	30	24	36	SCD350-0555-2-2-140HA04-HP765	30421723
5,60	6	66	30	24	36	SCD350-0560-2-2-140HA04-HP765	30421725
5,70	6	66	30	24	36	SCD350-0570-2-2-140HA04-HP765	30421726
5,80	6	66	30	24	36	SCD350-0580-2-2-140HA04-HP765	30421727
5,90	6	66	30	24	36	SCD350-0590-2-2-140HA04-HP765	30421728
6,00	6	66	30	24	36	SCD350-0600-2-2-140HA04-HP765	30421731
6,10	8	79	38	30	36	SCD350-0610-2-2-140HA04-HP765	30421732

ECU-Drill-Uni | Wiertła spiralne z węgla spiekane SCD350 (4xD), zewnętrzne doprowadzenie chłodziwa

Wymiary						Typ chwytu HA	
d ₁ m7	d ₂ h6	l ₁	l ₂	l ₃	l ₄	Specyfikacja	Nr materiałowy
6,20	8	79	38	30	36	SCD350-0620-2-2-140HA04-HP765	30421733
6,30	8	79	38	30	36	SCD350-0630-2-2-140HA04-HP765	30421734
6,40	8	79	38	30	36	SCD350-0640-2-2-140HA04-HP765	30421735
6,50	8	79	38	30	36	SCD350-0650-2-2-140HA04-HP765	30421736
6,60	8	79	38	30	36	SCD350-0660-2-2-140HA04-HP765	30421737
6,70	8	79	38	30	36	SCD350-0670-2-2-140HA04-HP765	30421738
6,80	8	79	38	30	36	SCD350-0680-2-2-140HA04-HP765	30421739
6,90	8	79	38	30	36	SCD350-0690-2-2-140HA04-HP765	30421740
7,00	8	79	38	30	36	SCD350-0700-2-2-140HA04-HP765	30421741
7,10	8	79	42	34	36	SCD350-0710-2-2-140HA04-HP765	30421742
7,20	8	79	42	34	36	SCD350-0720-2-2-140HA04-HP765	30421743
7,30	8	79	42	34	36	SCD350-0730-2-2-140HA04-HP765	30421744
7,40	8	79	42	34	36	SCD350-0740-2-2-140HA04-HP765	30421745
7,50	8	79	42	34	36	SCD350-0750-2-2-140HA04-HP765	30421746
7,60	8	79	42	34	36	SCD350-0760-2-2-140HA04-HP765	30421748
7,70	8	79	42	34	36	SCD350-0770-2-2-140HA04-HP765	30421749
7,80	8	79	42	34	36	SCD350-0780-2-2-140HA04-HP765	30421750
7,90	8	79	42	34	36	SCD350-0790-2-2-140HA04-HP765	30421751
8,00	8	79	42	34	36	SCD350-0800-2-2-140HA04-HP765	30421752
8,10	10	89	49	38	40	SCD350-0810-2-2-140HA04-HP765	30421753
8,20	10	89	49	38	40	SCD350-0820-2-2-140HA04-HP765	30421754
8,30	10	89	49	38	40	SCD350-0830-2-2-140HA04-HP765	30421755
8,40	10	89	49	38	40	SCD350-0840-2-2-140HA04-HP765	30421756
8,50	10	89	49	38	40	SCD350-0850-2-2-140HA04-HP765	30421757
8,60	10	89	49	38	40	SCD350-0860-2-2-140HA04-HP765	30421758
8,70	10	89	49	38	40	SCD350-0870-2-2-140HA04-HP765	30421759
8,80	10	89	49	38	40	SCD350-0880-2-2-140HA04-HP765	30421760
8,90	10	89	49	38	40	SCD350-0890-2-2-140HA04-HP765	30421761
9,00	10	89	49	38	40	SCD350-0900-2-2-140HA04-HP765	30421762
9,10	10	89	49	38	40	SCD350-0910-2-2-140HA04-HP765	30421763
9,20	10	89	49	38	40	SCD350-0920-2-2-140HA04-HP765	30421764
9,30*	10	89	49	40	40	SCD350-0930-2-2-140HA04-HP765	30421766
9,40	10	89	49	40	40	SCD350-0940-2-2-140HA04-HP765	30421767
9,50	10	89	49	40	40	SCD350-0950-2-2-140HA04-HP765	30421768
9,60	10	89	49	40	40	SCD350-0960-2-2-140HA04-HP765	30421769
9,70	10	89	49	40	40	SCD350-0970-2-2-140HA04-HP765	30421770
9,80	10	89	49	40	40	SCD350-0980-2-2-140HA04-HP765	30421771
9,90	10	89	49	40	40	SCD350-0990-2-2-140HA04-HP765	30421772
10,00	10	89	49	40	40	SCD350-1000-2-2-140HA04-HP765	30421773
10,10	12	102	56	45	45	SCD350-1010-2-2-140HA04-HP765	30421774
10,20	12	102	56	45	45	SCD350-1020-2-2-140HA04-HP765	30421775
10,30	12	102	56	45	45	SCD350-1030-2-2-140HA04-HP765	30421776
10,40	12	102	56	45	45	SCD350-1040-2-2-140HA04-HP765	30421777
10,50	12	102	56	45	45	SCD350-1050-2-2-140HA04-HP765	30421778
10,60	12	102	56	45	45	SCD350-1060-2-2-140HA04-HP765	30421779
10,80	12	102	56	45	45	SCD350-1080-2-2-140HA04-HP765	30421781
10,90	12	102	56	45	45	SCD350-1090-2-2-140HA04-HP765	30421782
11,00	12	102	56	45	45	SCD350-1100-2-2-140HA04-HP765	30421783
11,10	12	102	56	45	45	SCD350-1110-2-2-140HA04-HP765	30421784
11,20*	12	102	56	45	45	SCD350-1120-2-2-140HA04-HP765	30421785
11,30	12	102	56	45	45	SCD350-1130-2-2-140HA04-HP765	30421786
11,40	12	102	56	45	45	SCD350-1140-2-2-140HA04-HP765	30421787
11,50	12	102	56	45	45	SCD350-1150-2-2-140HA04-HP765	30421788
11,60	12	102	56	45	45	SCD350-1160-2-2-140HA04-HP765	30421789
11,70	12	102	56	45	45	SCD350-1170-2-2-140HA04-HP765	30421790

ECU-Drill-Uni | Wiertła spiralne z węgla spiekanego SCD350 (4xD), zewnętrzne doprowadzenie chłodziwa

Wymiary						Typ chwytu HA	
d ₁ m7	d ₂ h6	l ₁	l ₂	l ₃	l ₄	Specyfikacja	Nr materiałowy
11,80	12	102	56	45	45	SCD350-1180-2-2-140HA04-HP765	30421791
12,00	12	102	56	45	45	SCD350-1200-2-2-140HA04-HP765	30421793
12,20	14	107	61	50	45	SCD350-1220-2-2-140HA04-HP765	30421794
12,50	14	107	61	50	45	SCD350-1250-2-2-140HA04-HP765	30421795
12,80	14	107	61	50	45	SCD350-1280-2-2-140HA04-HP765	30421798
13,00	14	107	61	50	45	SCD350-1300-2-2-140HA04-HP765	30421799
13,50	14	107	61	50	45	SCD350-1350-2-2-140HA04-HP765	30421800
13,80	14	107	61	50	45	SCD350-1380-2-2-140HA04-HP765	30421802
14,00	14	107	61	50	45	SCD350-1400-2-2-140HA04-HP765	30421803
14,20	16	115	65	51	48	SCD350-1420-2-2-140HA04-HP765	30421804
14,50	16	115	65	51	48	SCD350-1450-2-2-140HA04-HP765	30421805
14,80	16	115	65	51	48	SCD350-1480-2-2-140HA04-HP765	30421807
15,00	16	115	65	51	48	SCD350-1500-2-2-140HA04-HP765	30421808
15,10	16	115	65	51	48	SCD350-1510-2-2-140HA04-HP765	30421809
15,20	16	115	65	51	48	SCD350-1520-2-2-140HA04-HP765	30421810
15,50	16	115	65	51	48	SCD350-1550-2-2-140HA04-HP765	30421811
15,70	16	115	65	51	48	SCD350-1570-2-2-140HA04-HP765	30421813
15,80	16	115	65	51	48	SCD350-1580-2-2-140HA04-HP765	30421814
16,00	16	115	65	51	48	SCD350-1600-2-2-140HA04-HP765	30421815
16,50	18	123	73	53	48	SCD350-1650-2-2-140HA04-HP765	30421817
17,00	18	123	73	53	48	SCD350-1700-2-2-140HA04-HP765	30421818
17,50	18	123	73	53	48	SCD350-1750-2-2-140HA04-HP765	30421820
17,70	18	123	73	53	48	SCD350-1770-2-2-140HA04-HP765	30421821
18,00	18	123	73	53	48	SCD350-1800-2-2-140HA04-HP765	30421822
18,50	20	131	79	55	50	SCD350-1850-2-2-140HA04-HP765	30421823
19,00	20	131	79	55	50	SCD350-1900-2-2-140HA04-HP765	30421824
19,50	20	131	79	55	50	SCD350-1950-2-2-140HA04-HP765	30421826
20,00	20	131	79	55	50	SCD350-2000-2-2-140HA04-HP765	30421827

Możliwość konfiguracji parametrów



Typ chwytu:
Typ chwytu: HB | HE



Specyfikacja:
SCD350-0430-3-3-140[typ chwytu]04-HP765

Przykład:

SCD350-0430-3-3-140HE04-HP765

Typ chwytu HE

Wymiary podano w mm.

*Nadaje się w szczególności do wiercenia otworów pod gwinty wykonywanych gniotownikami.

Zalecane parametry skrawania - patrz koniec rozdziału.

Wersje specjalne i inne powłoki wg zapytania ofertowego.

ECU-Drill-Uni

Wiertła spiralne z węgliku spiekanego
SCD351 (6xD), wewnętrzne doprowadzenie chłodziwa

Wersja:

Średnica wiertła: 3,00 - 20,00 mm

Tolerancja otworu: \geq IT 9

Materiał skrawający: HP765

Liczba ostrzy: 2

Kąt wierzchołkowy: 140°

Kąt spirali: 30°

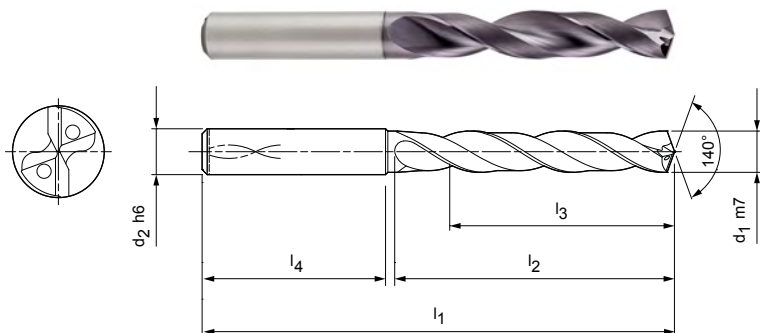

Magazynowa seria preferowana z typem chwytu HA

Wymiary						Typ chwytu HA	
d ₁ m7	d ₂ h6	l ₁	l ₂	l ₃	l ₄	Specyfikacja	Nr materiałowy
3,00	6	66	28	23	36	SCD351-0300-2-2-140HA06-HP765	30421958
3,10	6	66	28	23	36	SCD351-0310-2-2-140HA06-HP765	30421959
3,20	6	66	28	23	36	SCD351-0320-2-2-140HA06-HP765	30421960
3,30	6	66	28	23	36	SCD351-0330-2-2-140HA06-HP765	30421961
3,40	6	66	28	23	36	SCD351-0340-2-2-140HA06-HP765	30421962
3,50	6	66	28	23	36	SCD351-0350-2-2-140HA06-HP765	30421963
3,60	6	66	28	23	36	SCD351-0360-2-2-140HA06-HP765	30421964
3,70*	6	66	28	23	36	SCD351-0370-2-2-140HA06-HP765	30421965
3,80	6	74	36	29	36	SCD351-0380-2-2-140HA06-HP765	30421966
3,90	6	74	36	29	36	SCD351-0390-2-2-140HA06-HP765	30421967
4,00	6	74	36	29	36	SCD351-0400-2-2-140HA06-HP765	30421968
4,10	6	74	36	29	36	SCD351-0410-2-2-140HA06-HP765	30421969
4,20	6	74	36	29	36	SCD351-0420-2-2-140HA06-HP765	30421970
4,30	6	74	36	29	36	SCD351-0430-2-2-140HA06-HP765	30421971
4,40	6	74	36	29	36	SCD351-0440-2-2-140HA06-HP765	30421972
4,50	6	74	36	29	36	SCD351-0450-2-2-140HA06-HP765	30421973
4,60	6	74	36	29	36	SCD351-0460-2-2-140HA06-HP765	30421974
4,65*	6	74	36	29	36	SCD351-0465-2-2-140HA06-HP765	30421975
4,70	6	74	36	29	36	SCD351-0470-2-2-140HA06-HP765	30421976
4,80	6	82	44	35	36	SCD351-0480-2-2-140HA06-HP765	30421977
4,90	6	82	44	35	36	SCD351-0490-2-2-140HA06-HP765	30421978
5,00	6	82	44	35	36	SCD351-0500-2-2-140HA06-HP765	30421979
5,10	6	82	44	35	36	SCD351-0510-2-2-140HA06-HP765	30421980
5,20	6	82	44	35	36	SCD351-0520-2-2-140HA06-HP765	30421981
5,30	6	82	44	35	36	SCD351-0530-2-2-140HA06-HP765	30421982
5,40	6	82	44	35	36	SCD351-0540-2-2-140HA06-HP765	30421983
5,50	6	82	44	35	36	SCD351-0550-2-2-140HA06-HP765	30421984
5,55*	6	82	44	35	36	SCD351-0555-2-2-140HA06-HP765	30421985
5,60	6	82	44	35	36	SCD351-0560-2-2-140HA06-HP765	30421987
5,70	6	82	44	35	36	SCD351-0570-2-2-140HA06-HP765	30421988
5,80	6	82	44	35	36	SCD351-0580-2-2-140HA06-HP765	30421989
5,90	6	82	44	35	36	SCD351-0590-2-2-140HA06-HP765	30421990
6,00	6	82	44	35	36	SCD351-0600-2-2-140HA06-HP765	30421991
6,10	8	91	53	43	36	SCD351-0610-2-2-140HA06-HP765	30421992
6,20	8	91	53	43	36	SCD351-0620-2-2-140HA06-HP765	30421993

ECU-Drill-Uni | Wiertła spiralne z węgla spiekane SCD351 (6xD), wewnętrzne doprowadzenie chłodziwa

Wymiary						Typ chwytu HA	
d ₁ m7	d ₂ h6	l ₁	l ₂	l ₃	l ₄	Specyfikacja	Nr materiałowy
6,30	8	91	53	43	36	SCD351-0630-2-2-140HA06-HP765	30421994
6,40	8	91	53	43	36	SCD351-0640-2-2-140HA06-HP765	30421995
6,50	8	91	53	43	36	SCD351-0650-2-2-140HA06-HP765	30421996
6,60	8	91	53	43	36	SCD351-0660-2-2-140HA06-HP765	30421997
6,70	8	91	53	43	36	SCD351-0670-2-2-140HA06-HP765	30421998
6,80	8	91	53	43	36	SCD351-0680-2-2-140HA06-HP765	30421999
6,90	8	91	53	43	36	SCD351-0690-2-2-140HA06-HP765	30422000
7,00	8	91	53	43	36	SCD351-0700-2-2-140HA06-HP765	30422001
7,10	8	91	53	43	36	SCD351-0710-2-2-140HA06-HP765	30422002
7,20	8	91	53	43	36	SCD351-0720-2-2-140HA06-HP765	30422003
7,30	8	91	53	43	36	SCD351-0730-2-2-140HA06-HP765	30422004
7,40	8	91	53	43	36	SCD351-0740-2-2-140HA06-HP765	30422005
7,45*	8	91	53	43	36	SCD351-0745-2-2-140HA06-HP765	30569230
7,50	8	91	53	43	36	SCD351-0750-2-2-140HA06-HP765	30422006
7,60	8	91	53	43	36	SCD351-0760-2-2-140HA06-HP765	30422008
7,70	8	91	53	43	36	SCD351-0770-2-2-140HA06-HP765	30422009
7,80	8	91	53	43	36	SCD351-0780-2-2-140HA06-HP765	30422010
7,90	8	91	53	43	36	SCD351-0790-2-2-140HA06-HP765	30422011
8,00	8	91	53	43	36	SCD351-0800-2-2-140HA06-HP765	30422012
8,10	10	103	61	49	40	SCD351-0810-2-2-140HA06-HP765	30422013
8,20	10	103	61	49	40	SCD351-0820-2-2-140HA06-HP765	30422014
8,30	10	103	61	49	40	SCD351-0830-2-2-140HA06-HP765	30422015
8,40	10	103	61	49	40	SCD351-0840-2-2-140HA06-HP765	30422016
8,50	10	103	61	49	40	SCD351-0850-2-2-140HA06-HP765	30422017
8,60	10	103	61	49	40	SCD351-0860-2-2-140HA06-HP765	30422018
8,70	10	103	61	49	40	SCD351-0870-2-2-140HA06-HP765	30422019
8,80	10	103	61	49	40	SCD351-0880-2-2-140HA06-HP765	30422020
8,90	10	103	61	49	40	SCD351-0890-2-2-140HA06-HP765	30422021
9,00	10	103	61	49	40	SCD351-0900-2-2-140HA06-HP765	30422022
9,10	10	103	61	49	40	SCD351-0910-2-2-140HA06-HP765	30422023
9,20	10	103	61	49	40	SCD351-0920-2-2-140HA06-HP765	30422024
9,30*	10	103	61	49	40	SCD351-0930-2-2-140HA06-HP765	30422026
9,40	10	103	61	49	40	SCD351-0940-2-2-140HA06-HP765	30422027
9,50	10	103	61	49	40	SCD351-0950-2-2-140HA06-HP765	30422028
9,60	10	103	61	49	40	SCD351-0960-2-2-140HA06-HP765	30422029
9,70	10	103	61	49	40	SCD351-0970-2-2-140HA06-HP765	30422030
9,80	10	103	61	49	40	SCD351-0980-2-2-140HA06-HP765	30422031
9,90	10	103	61	49	40	SCD351-0990-2-2-140HA06-HP765	30422032
10,00	10	103	61	49	40	SCD351-1000-2-2-140HA06-HP765	30422033
10,10	12	118	71	56	45	SCD351-1010-2-2-140HA06-HP765	30422034
10,20	12	118	71	56	45	SCD351-1020-2-2-140HA06-HP765	30422035
10,30	12	118	71	56	45	SCD351-1030-2-2-140HA06-HP765	30422036
10,40	12	118	71	56	45	SCD351-1040-2-2-140HA06-HP765	30422037
10,50	12	118	71	56	45	SCD351-1050-2-2-140HA06-HP765	30422038
10,60	12	118	71	56	45	SCD351-1060-2-2-140HA06-HP765	30422039
10,70	12	118	71	56	45	SCD351-1070-2-2-140HA06-HP765	30422040
10,80	12	118	71	56	45	SCD351-1080-2-2-140HA06-HP765	30422041
10,90	12	118	71	56	45	SCD351-1090-2-2-140HA06-HP765	30422042
11,00	12	118	71	56	45	SCD351-1100-2-2-140HA06-HP765	30422043
11,10	12	118	71	56	45	SCD351-1110-2-2-140HA06-HP765	30422044
11,20*	12	118	71	56	45	SCD351-1120-2-2-140HA06-HP765	30422045
11,30	12	118	71	56	45	SCD351-1130-2-2-140HA06-HP765	30422046
11,50	12	118	71	56	45	SCD351-1150-2-2-140HA06-HP765	30422048
11,60	12	118	71	56	45	SCD351-1160-2-2-140HA06-HP765	30422049
11,80	12	118	71	56	45	SCD351-1180-2-2-140HA06-HP765	30422051
11,90	12	118	71	56	45	SCD351-1190-2-2-140HA06-HP765	30422052
12,00	12	118	71	56	45	SCD351-1200-2-2-140HA06-HP765	30422053

Ciąg dalszy na następnej stronie.

ECU-Drill-Uni | Wiertła spiralne z węgla spiekanego SCD351 (6xD), wewnętrzne doprowadzenie chłodziwa

Wymiary						Typ chwytu HA	
d ₁ m7	d ₂ h6	l ₁	l ₂	l ₃	l ₄	Specyfikacja	Nr materiałowy
12,20	14	124	77	60	45	SCD351-1220-2-2-140HA06-HP765	30422054
12,50	14	124	77	60	45	SCD351-1250-2-2-140HA06-HP765	30422055
12,70	14	124	77	60	45	SCD351-1270-2-2-140HA06-HP765	30422056
12,80	14	124	77	60	45	SCD351-1280-2-2-140HA06-HP765	30422057
13,00	14	124	77	60	45	SCD351-1300-2-2-140HA06-HP765	30422058
13,50	14	124	77	60	45	SCD351-1350-2-2-140HA06-HP765	30422059
13,70	14	124	77	60	45	SCD351-1370-2-2-140HA06-HP765	30422060
13,80	14	124	77	60	45	SCD351-1380-2-2-140HA06-HP765	30422061
14,00	14	124	77	60	45	SCD351-1400-2-2-140HA06-HP765	30422062
14,20	16	133	83	63	48	SCD351-1420-2-2-140HA06-HP765	30422063
14,50	16	133	83	63	48	SCD351-1450-2-2-140HA06-HP765	30422064
14,80	16	133	83	63	48	SCD351-1480-2-2-140HA06-HP765	30422066
15,00	16	133	83	63	48	SCD351-1500-2-2-140HA06-HP765	30422067
15,50	16	133	83	63	48	SCD351-1550-2-2-140HA06-HP765	30422069
15,70	16	133	83	63	48	SCD351-1570-2-2-140HA06-HP765	30422070
15,80	16	133	83	63	48	SCD351-1580-2-2-140HA06-HP765	30422071
16,00	16	133	83	63	48	SCD351-1600-2-2-140HA06-HP765	30422072
16,50	18	143	93	71	48	SCD351-1650-2-2-140HA06-HP765	30422073
17,00	18	143	93	71	48	SCD351-1700-2-2-140HA06-HP765	30422074
17,50	18	143	93	71	48	SCD351-1750-2-2-140HA06-HP765	30422075
18,00	18	143	93	71	48	SCD351-1800-2-2-140HA06-HP765	30422076
18,50	20	153	101	77	50	SCD351-1850-2-2-140HA06-HP765	30422077
19,00	20	153	101	77	50	SCD351-1900-2-2-140HA06-HP765	30422078
19,50	20	153	101	77	50	SCD351-1950-2-2-140HA06-HP765	30422079
20,00	20	153	101	77	50	SCD351-2000-2-2-140HA06-HP765	30422080

Możliwość konfiguracji parametrów



Typ chwytu:
Typ chwytu: HB | HE



Specyfikacja:
SCD351-0430-3-3-140[typ chwytu]06-HP765

Przykład:

SCD351-0430-3-3-140HE06-HP765

Typ chwytu HE

Wymiary podano w mm.

*Nadaje się w szczególności do wiercenia otworów pod gwinty wykonywanych gniotownikami.

Zalecane parametry skrawania - patrz koniec rozdziału.

Wersje specjalne i inne powłoki wg zapytania ofertowego.

MEGA-Drill-Steel-Plus

Wiertła spiralne z węgla spiekane

SCD600 (3xD), zewnętrzne doprowadzenie chłodziwa, następcą MEGA-Drill-Steel (SCD10)

Wersja:

Średnica wiertła: 3,00 – 25,00 mm
 Tolerancja otworu: \geq IT 9
 Materiał skrawający: HP358
 Liczba ostrzy: 2
 Liczba łysinek: 2
 Kąt wierzchołkowy: 140°
 Kąt spirali: 30°

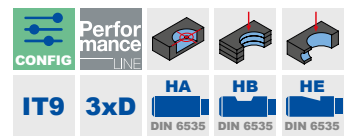
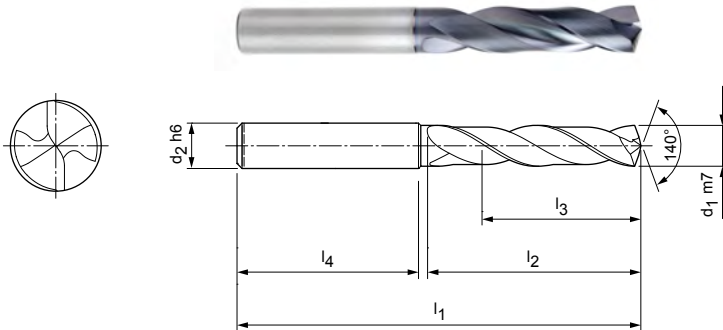

Magazynowa seria preferowana z typem chwytu HA

Wymiary						Typ chwytu HA	
d ₁ m7	d ₂ h6	l ₁	l ₂	l ₃	l ₄	Specyfikacja	Nr materiałowy
3,00	6	62	20	14	36	SCD600-0300-2-2-140HA03-HP358	30801131
3,10	6	62	20	14	36	SCD600-0310-2-2-140HA03-HP358	30801132
3,15	6	62	20	14	36	SCD600-0315-2-2-140HA03-HP358	30801133
3,20	6	62	20	14	36	SCD600-0320-2-2-140HA03-HP358	30801134
3,25	6	62	20	14	36	SCD600-0325-2-2-140HA03-HP358	30801136
3,30	6	62	20	14	36	SCD600-0330-2-2-140HA03-HP358	30801137
3,40	6	62	20	14	36	SCD600-0340-2-2-140HA03-HP358	30801138
3,50	6	62	20	14	36	SCD600-0350-2-2-140HA03-HP358	30801139
3,60	6	62	20	14	36	SCD600-0360-2-2-140HA03-HP358	30801140
3,70*	6	62	20	14	36	SCD600-0370-2-2-140HA03-HP358	30801141
3,80	6	66	24	17	36	SCD600-0380-2-2-140HA03-HP358	30801142
3,85	6	66	24	17	36	SCD600-0385-2-2-140HA03-HP358	30801143
3,90	6	66	24	17	36	SCD600-0390-2-2-140HA03-HP358	30801144
4,00	6	66	24	17	36	SCD600-0400-2-2-140HA03-HP358	30801145
4,10	6	66	24	17	36	SCD600-0410-2-2-140HA03-HP358	30801146
4,20	6	66	24	17	36	SCD600-0420-2-2-140HA03-HP358	30801147
4,25	6	66	24	17	36	SCD600-0425-2-2-140HA03-HP358	30801148
4,30	6	66	24	17	36	SCD600-0430-2-2-140HA03-HP358	30801149
4,35	6	66	24	17	36	SCD600-0435-2-2-140HA03-HP358	30801150
4,40	6	66	24	17	36	SCD600-0440-2-2-140HA03-HP358	30801151
4,45	6	66	24	17	36	SCD600-0445-2-2-140HA03-HP358	30801152
4,50	6	66	24	17	36	SCD600-0450-2-2-140HA03-HP358	30801153
4,60	6	66	24	17	36	SCD600-0460-2-2-140HA03-HP358	30801154
4,65*	6	66	24	17	36	SCD600-0465-2-2-140HA03-HP358	30801155
4,70	6	66	24	17	36	SCD600-0470-2-2-140HA03-HP358	30801156
4,80	6	66	28	20	36	SCD600-0480-2-2-140HA03-HP358	30801157
4,90	6	66	28	20	36	SCD600-0490-2-2-140HA03-HP358	30801158
4,95	6	66	28	20	36	SCD600-0495-2-2-140HA03-HP358	30801159
5,00	6	66	28	20	36	SCD600-0500-2-2-140HA03-HP358	30801160
5,05	6	66	28	20	36	SCD600-0505-2-2-140HA03-HP358	30801161
5,10	6	66	28	20	36	SCD600-0510-2-2-140HA03-HP358	30801162
5,20	6	66	28	20	36	SCD600-0520-2-2-140HA03-HP358	30801163
5,30	6	66	28	20	36	SCD600-0530-2-2-140HA03-HP358	30801164
5,40	6	66	28	20	36	SCD600-0540-2-2-140HA03-HP358	30801165
5,50	6	66	28	20	36	SCD600-0550-2-2-140HA03-HP358	30801166

MEGA-Drill-Steel-Plus | Wiertła spiralne z węgla spiekane SCD600 (3xD), zewnętrzne doprowadzenie chłodziwa

Wymiary						Typ chwytu HA	
d ₁ m7	d ₂ h6	l ₁	l ₂	l ₃	l ₄	Specyfikacja	Nr materiałowy
5,55*	6	66	28	20	36	SCD600-0555-2-2-140HA03-HP358	30801167
5,60	6	66	28	20	36	SCD600-0560-2-2-140HA03-HP358	30801168
5,70	6	66	28	20	36	SCD600-0570-2-2-140HA03-HP358	30801169
5,75	6	66	28	20	36	SCD600-0575-2-2-140HA03-HP358	30801170
5,80	6	66	28	20	36	SCD600-0580-2-2-140HA03-HP358	30801171
5,90	6	66	28	20	36	SCD600-0590-2-2-140HA03-HP358	30801172
5,95	6	66	28	20	36	SCD600-0595-2-2-140HA03-HP358	30801173
6,00	6	66	28	20	36	SCD600-0600-2-2-140HA03-HP358	30801174
6,10	8	79	34	24	36	SCD600-0610-2-2-140HA03-HP358	30801175
6,20	8	79	34	24	36	SCD600-0620-2-2-140HA03-HP358	30801176
6,30	8	79	34	24	36	SCD600-0630-2-2-140HA03-HP358	30801177
6,40	8	79	34	24	36	SCD600-0640-2-2-140HA03-HP358	30801178
6,50	8	79	34	24	36	SCD600-0650-2-2-140HA03-HP358	30801179
6,60	8	79	34	24	36	SCD600-0660-2-2-140HA03-HP358	30801180
6,70	8	79	34	24	36	SCD600-0670-2-2-140HA03-HP358	30801181
6,80	8	79	34	24	36	SCD600-0680-2-2-140HA03-HP358	30801182
6,90	8	79	34	24	36	SCD600-0690-2-2-140HA03-HP358	30801183
7,00	8	79	34	24	36	SCD600-0700-2-2-140HA03-HP358	30801184
7,10	8	79	41	29	36	SCD600-0710-2-2-140HA03-HP358	30801185
7,20	8	79	41	29	36	SCD600-0720-2-2-140HA03-HP358	30801186
7,30	8	79	41	29	36	SCD600-0730-2-2-140HA03-HP358	30801187
7,40	8	79	41	29	36	SCD600-0740-2-2-140HA03-HP358	30801188
7,45*	8	79	41	29	36	SCD600-0745-2-2-140HA03-HP358	30801189
7,50	8	79	41	29	36	SCD600-0750-2-2-140HA03-HP358	30801190
7,60	8	79	41	29	36	SCD600-0760-2-2-140HA03-HP358	30801191
7,70	8	79	41	29	36	SCD600-0770-2-2-140HA03-HP358	30801192
7,80	8	79	41	29	36	SCD600-0780-2-2-140HA03-HP358	30801193
7,90	8	79	41	29	36	SCD600-0790-2-2-140HA03-HP358	30801194
8,00	8	79	41	29	36	SCD600-0800-2-2-140HA03-HP358	30801195
8,10	10	89	47	35	40	SCD600-0810-2-2-140HA03-HP358	30801196
8,20	10	89	47	35	40	SCD600-0820-2-2-140HA03-HP358	30801197
9,10	10	89	47	35	40	SCD600-0910-2-2-140HA03-HP358	30801206
9,20	10	89	47	35	40	SCD600-0920-2-2-140HA03-HP358	30801207
9,30*	10	89	47	35	40	SCD600-0930-2-2-140HA03-HP358	30801208
9,35	10	89	47	35	40	SCD600-0935-2-2-140HA03-HP358	30801209
9,50	10	89	47	35	40	SCD600-0950-2-2-140HA03-HP358	30801212
9,60	10	89	47	35	40	SCD600-0960-2-2-140HA03-HP358	30801213
9,70	10	89	47	35	40	SCD600-0970-2-2-140HA03-HP358	30801214
9,80	10	89	47	35	40	SCD600-0980-2-2-140HA03-HP358	30801215
9,90	10	89	47	35	40	SCD600-0990-2-2-140HA03-HP358	30801216
10,00	10	89	47	35	40	SCD600-1000-2-2-140HA03-HP358	30801217
10,10	12	102	55	40	45	SCD600-1010-2-2-140HA03-HP358	30801218
10,20	12	102	55	40	45	SCD600-1020-2-2-140HA03-HP358	30801219
10,30	12	102	55	40	45	SCD600-1030-2-2-140HA03-HP358	30801220
10,40	12	102	55	40	45	SCD600-1040-2-2-140HA03-HP358	30801221
10,50	12	102	55	40	45	SCD600-1050-2-2-140HA03-HP358	30801222
10,55	12	102	55	40	45	SCD600-1055-2-2-140HA03-HP358	30801223
10,60	12	102	55	40	45	SCD600-1060-2-2-140HA03-HP358	30801224
10,70	12	102	55	40	45	SCD600-1070-2-2-140HA03-HP358	30801225
10,80	12	102	55	40	45	SCD600-1080-2-2-140HA03-HP358	30801227
10,90	12	102	55	40	45	SCD600-1090-2-2-140HA03-HP358	30801228
11,00	12	102	55	40	45	SCD600-1100-2-2-140HA03-HP358	30801229
11,10	12	102	55	40	45	SCD600-1110-2-2-140HA03-HP358	30801230
11,20*	12	102	55	40	45	SCD600-1120-2-2-140HA03-HP358	30801231
11,25	12	102	55	40	45	SCD600-1125-2-2-140HA03-HP358	30801232
11,30	12	102	55	40	45	SCD600-1130-2-2-140HA03-HP358	30801233
11,35	12	102	55	40	45	SCD600-1135-2-2-140HA03-HP358	30801234

MEGA-Drill-Steel-Plus | Wiertła spiralne z węgla spiekane SCD600 (3xD), zewnętrzne doprowadzenie chłodziwa

Wymiary						Typ chwytu HA	
d ₁ m7	d ₂ h6	l ₁	l ₂	l ₃	l ₄	Specyfikacja	Nr materiałowy
11,40	12	102	55	40	45	SCD600-1140-2-2-140HA03-HP358	30801235
11,50	12	102	55	40	45	SCD600-1150-2-2-140HA03-HP358	30801237
11,60	12	102	55	40	45	SCD600-1160-2-2-140HA03-HP358	30801238
11,70	12	102	55	40	45	SCD600-1170-2-2-140HA03-HP358	30801239
11,80	12	102	55	40	45	SCD600-1180-2-2-140HA03-HP358	30801240
11,90	12	102	55	40	45	SCD600-1190-2-2-140HA03-HP358	30801241
12,00	12	102	55	40	45	SCD600-1200-2-2-140HA03-HP358	30801242
12,15	14	107	60	43	45	SCD600-1215-2-2-140HA03-HP358	30801243
12,25	14	107	60	43	45	SCD600-1225-2-2-140HA03-HP358	30801244
12,50	14	107	60	43	45	SCD600-1250-2-2-140HA03-HP358	30801245
12,55	14	107	60	43	45	SCD600-1255-2-2-140HA03-HP358	30801246
12,70	14	107	60	43	45	SCD600-1270-2-2-140HA03-HP358	30801247
12,80	14	107	60	43	45	SCD600-1280-2-2-140HA03-HP358	30801248
13,00	14	107	60	43	45	SCD600-1300-2-2-140HA03-HP358	30801250
13,10	14	107	60	43	45	SCD600-1310-2-2-140HA03-HP358	30801251
13,30	14	107	60	43	45	SCD600-1330-2-2-140HA03-HP358	30801252
13,35	14	107	60	43	45	SCD600-1335-2-2-140HA03-HP358	30801253
13,50	14	107	60	43	45	SCD600-1350-2-2-140HA03-HP358	30801254
13,70	14	107	60	43	45	SCD600-1370-2-2-140HA03-HP358	30801255
13,80	14	107	60	43	45	SCD600-1380-2-2-140HA03-HP358	30801256
14,00	14	107	60	43	45	SCD600-1400-2-2-140HA03-HP358	30801257
14,20	16	115	65	45	48	SCD600-1420-2-2-140HA03-HP358	30801258
14,50	16	115	65	45	48	SCD600-1450-2-2-140HA03-HP358	30801259
14,80	16	115	65	45	48	SCD600-1480-2-2-140HA03-HP358	30801260
15,00	16	115	65	45	48	SCD600-1500-2-2-140HA03-HP358	30801261
15,10	16	115	65	45	48	SCD600-1510-2-2-140HA03-HP358	30801262
15,25	16	115	65	45	48	SCD600-1525-2-2-140HA03-HP358	30801263
15,30	16	115	65	45	48	SCD600-1530-2-2-140HA03-HP358	30801264
15,35	16	115	65	45	48	SCD600-1535-2-2-140HA03-HP358	30801265
15,50	16	115	65	45	48	SCD600-1550-2-2-140HA03-HP358	30801266
15,60	16	115	65	45	48	SCD600-1560-2-2-140HA03-HP358	30801267
15,80	16	115	65	45	48	SCD600-1580-2-2-140HA03-HP358	30801268
16,00	16	115	65	45	48	SCD600-1600-2-2-140HA03-HP358	30801269
16,05	18	123	73	51	48	SCD600-1605-2-2-140HA03-HP358	30801270
16,50	18	123	73	51	48	SCD600-1650-2-2-140HA03-HP358	30801271
16,80	18	123	73	51	48	SCD600-1680-2-2-140HA03-HP358	30801272
17,00	18	123	73	51	48	SCD600-1700-2-2-140HA03-HP358	30801274
17,50	18	123	73	51	48	SCD600-1750-2-2-140HA03-HP358	30801275
17,80	18	123	73	51	48	SCD600-1780-2-2-140HA03-HP358	30801277
18,00	18	123	73	51	48	SCD600-1800-2-2-140HA03-HP358	30801278
18,50	20	131	79	55	50	SCD600-1850-2-2-140HA03-HP358	30801279
19,00	20	131	79	55	50	SCD600-1900-2-2-140HA03-HP358	30801282
19,35	20	131	79	55	50	SCD600-1935-2-2-140HA03-HP358	30801283
19,60	20	131	79	55	50	SCD600-1960-2-2-140HA03-HP358	30801285
19,80	20	131	79	55	50	SCD600-1980-2-2-140HA03-HP358	30801286
20,00	20	131	79	55	50	SCD600-2000-2-2-140HA03-HP358	30801287

Ciąg dalszy na następnej stronie.

MEGA-Drill-Steel-Plus | Wiertła spiralne z węgla spiekane SCD600 (3xD), zewnętrzne doprowadzenie chłodziwa

Możliwość konfiguracji parametrów



Średnica:
możliwość wyboru średnicy w
krokach co 0,01 mm



Typ chwytu:
Typ chwytu: HB | HE

Specyfikacja:

SCD600-[średnica]-3-3-140[typ chwytu]03-HP358

Przykład:

SCD600-0431-3-3-140HE03-HP358

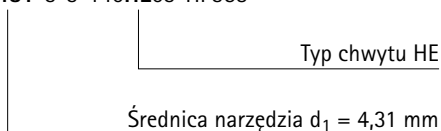

Wymiary typoszeregu z możliwością konfiguracji parametrów

d ₁ min.	d ₁ max.	d ₂ h6	l ₁	l ₂	l ₃	l ₄
3,00	3,70	6	62	20	14	36
3,71	4,70	6	66	24	17	36
4,71	6,00	6	66	28	20	36
6,01	7,00	8	79	34	24	36
7,01	8,00	8	79	41	29	36
8,01	10,00	10	89	47	35	40
10,01	12,00	12	102	55	40	45
12,01	14,00	14	107	60	43	45
14,01	16,00	16	115	65	45	48
16,01	18,00	18	123	73	51	48
18,01	20,00	20	131	79	55	50

Wymiary podano w mm.

* Nadaje się w szczególności do wiercenia otworów pod gwinty wykonywanych gniotownikami.

Zalecane parametry skrawania – patrz koniec rozdziału.

Wersje specjalne i inne powłoki wg zapytania ofertowego.

MEGA-Drill-Steel-Plus

Wiertła spiralne z węgla spiekanego

SCD601 (3xD), wewnętrzne doprowadzenie chłodziwa, następcą MEGA-Drill-Steel (SCD10)

Wersja:

Średnica wiertła: 3,00 – 25,00 mm
 Tolerancja otworu: ≥ IT 9
 Materiał skrawający: HP358
 Liczba ostrzy: 2
 Liczba łysinek: 2
 Kąt wierzchołkowy: 140°
 Kąt spirali: 30°

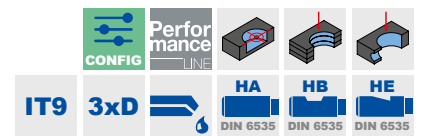
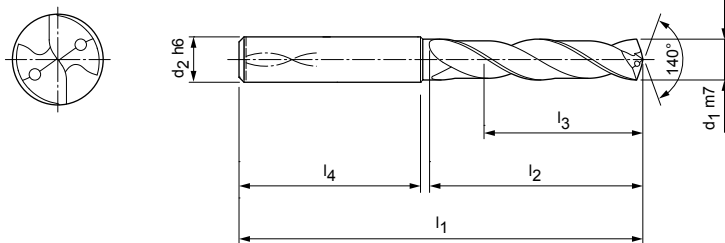

Magazynowa seria preferowana z typem chwytu HA

Wymiary						Typ chwytu HA	
d ₁ m7	d ₂ h6	l ₁	l ₂	l ₃	l ₄	Specyfikacja	Nr materiałowy
3,00	6	62	20	14	36	SCD601-0300-2-2-140HA03-HP358	30802107
3,10	6	62	20	14	36	SCD601-0310-2-2-140HA03-HP358	30802108
3,15	6	62	20	14	36	SCD601-0315-2-2-140HA03-HP358	30802109
3,20	6	62	20	14	36	SCD601-0320-2-2-140HA03-HP358	30802110
3,22	6	62	20	14	36	SCD601-0322-2-2-140HA03-HP358	30802111
3,25	6	62	20	14	36	SCD601-0325-2-2-140HA03-HP358	30802112
3,30	6	62	20	14	36	SCD601-0330-2-2-140HA03-HP358	30802113
3,40	6	62	20	14	36	SCD601-0340-2-2-140HA03-HP358	30802115
3,50	6	62	20	14	36	SCD601-0350-2-2-140HA03-HP358	30802116
3,60	6	62	20	14	36	SCD601-0360-2-2-140HA03-HP358	30802117
3,70*	6	62	20	14	36	SCD601-0370-2-2-140HA03-HP358	30802118
3,80	6	66	24	17	36	SCD601-0380-2-2-140HA03-HP358	30802119
3,85	6	66	24	17	36	SCD601-0385-2-2-140HA03-HP358	30802120
3,90	6	66	24	17	36	SCD601-0390-2-2-140HA03-HP358	30802121
4,00	6	66	24	17	36	SCD601-0400-2-2-140HA03-HP358	30802122
4,10	6	66	24	17	36	SCD601-0410-2-2-140HA03-HP358	30802123
4,20	6	66	24	17	36	SCD601-0420-2-2-140HA03-HP358	30802124
4,25	6	66	24	17	36	SCD601-0425-2-2-140HA03-HP358	30802125
4,30	6	66	24	17	36	SCD601-0430-2-2-140HA03-HP358	30802126
4,40	6	66	24	17	36	SCD601-0440-2-2-140HA03-HP358	30802129
4,50	6	66	24	17	36	SCD601-0450-2-2-140HA03-HP358	30802131
4,60	6	66	24	17	36	SCD601-0460-2-2-140HA03-HP358	30802132
4,65*	6	66	24	17	36	SCD601-0465-2-2-140HA03-HP358	30802133
4,70	6	66	24	17	36	SCD601-0470-2-2-140HA03-HP358	30802134
4,80	6	66	28	20	36	SCD601-0480-2-2-140HA03-HP358	30802135
4,90	6	66	28	20	36	SCD601-0490-2-2-140HA03-HP358	30802136
4,95	6	66	28	20	36	SCD601-0495-2-2-140HA03-HP358	30802137
5,00	6	66	28	20	36	SCD601-0500-2-2-140HA03-HP358	30802138
5,05	6	66	28	20	36	SCD601-0505-2-2-140HA03-HP358	30802139
5,10	6	66	28	20	36	SCD601-0510-2-2-140HA03-HP358	30802140
5,20	6	66	28	20	36	SCD601-0520-2-2-140HA03-HP358	30802141
5,30	6	66	28	20	36	SCD601-0530-2-2-140HA03-HP358	30802142
5,40	6	66	28	20	36	SCD601-0540-2-2-140HA03-HP358	30802143
5,50	6	66	28	20	36	SCD601-0550-2-2-140HA03-HP358	30802144
5,55*	6	66	28	20	36	SCD601-0555-2-2-140HA03-HP358	30802145

MEGA-Drill-Steel-Plus | Wiertło spiralne z węgla spiekane SCD601 (3xD), wewnętrzny dopływ środka chłodzącego

Wymiary						Typ chwytu HA	
d ₁ m7	d ₂ h6	l ₁	l ₂	l ₃	l ₄	Specyfikacja	Nr materiałowy
5,60	6	66	28	20	36	SCD601-0560-2-2-140HA03-HP358	30802146
5,70	6	66	28	20	36	SCD601-0570-2-2-140HA03-HP358	30802147
5,75	6	66	28	20	36	SCD601-0575-2-2-140HA03-HP358	30802148
5,80	6	66	28	20	36	SCD601-0580-2-2-140HA03-HP358	30802149
5,90	6	66	28	20	36	SCD601-0590-2-2-140HA03-HP358	30802150
5,95	6	66	28	20	36	SCD601-0595-2-2-140HA03-HP358	30802151
6,00	6	66	28	20	36	SCD601-0600-2-2-140HA03-HP358	30802152
6,10	8	79	34	24	36	SCD601-0610-2-2-140HA03-HP358	30802153
6,20	8	79	34	24	36	SCD601-0620-2-2-140HA03-HP358	30802154
6,30	8	79	34	24	36	SCD601-0630-2-2-140HA03-HP358	30802155
6,40	8	79	34	24	36	SCD601-0640-2-2-140HA03-HP358	30802156
6,50	8	79	34	24	36	SCD601-0650-2-2-140HA03-HP358	30802157
6,60	8	79	34	24	36	SCD601-0660-2-2-140HA03-HP358	30802158
6,70	8	79	34	24	36	SCD601-0670-2-2-140HA03-HP358	30802159
6,80	8	79	34	24	36	SCD601-0680-2-2-140HA03-HP358	30802160
6,90	8	79	34	24	36	SCD601-0690-2-2-140HA03-HP358	30802161
7,00	8	79	34	24	36	SCD601-0700-2-2-140HA03-HP358	30802162
7,10	8	79	41	29	36	SCD601-0710-2-2-140HA03-HP358	30802163
7,20	8	79	41	29	36	SCD601-0720-2-2-140HA03-HP358	30802164
7,30	8	79	41	29	36	SCD601-0730-2-2-140HA03-HP358	30802165
7,40	8	79	41	29	36	SCD601-0740-2-2-140HA03-HP358	30802166
7,45*	8	79	41	29	36	SCD601-0745-2-2-140HA03-HP358	30802167
7,50	8	79	41	29	36	SCD601-0750-2-2-140HA03-HP358	30802168
7,60	8	79	41	29	36	SCD601-0760-2-2-140HA03-HP358	30802169
7,70	8	79	41	29	36	SCD601-0770-2-2-140HA03-HP358	30802170
7,80	8	79	41	29	36	SCD601-0780-2-2-140HA03-HP358	30802171
7,90	8	79	41	29	36	SCD601-0790-2-2-140HA03-HP358	30802172
8,00	8	79	41	29	36	SCD601-0800-2-2-140HA03-HP358	30802173
8,10	10	89	47	35	40	SCD601-0810-2-2-140HA03-HP358	30802174
8,20	10	89	47	35	40	SCD601-0820-2-2-140HA03-HP358	30802175
8,30	10	89	47	35	40	SCD601-0830-2-2-140HA03-HP358	30802176
8,40	10	89	47	35	40	SCD601-0840-2-2-140HA03-HP358	30802177
8,50	10	89	47	35	40	SCD601-0850-2-2-140HA03-HP358	30802178
8,60	10	89	47	35	40	SCD601-0860-2-2-140HA03-HP358	30802179
8,70	10	89	47	35	40	SCD601-0870-2-2-140HA03-HP358	30802180
8,80	10	89	47	35	40	SCD601-0880-2-2-140HA03-HP358	30802181
8,90	10	89	47	35	40	SCD601-0890-2-2-140HA03-HP358	30802182
9,00	10	89	47	35	40	SCD601-0900-2-2-140HA03-HP358	30802183
9,10	10	89	47	35	40	SCD601-0910-2-2-140HA03-HP358	30802184
9,20	10	89	47	35	40	SCD601-0920-2-2-140HA03-HP358	30802185
9,30*	10	89	47	35	40	SCD601-0930-2-2-140HA03-HP358	30802186
9,35	10	89	47	35	40	SCD601-0935-2-2-140HA03-HP358	30802187
9,40	10	89	47	35	40	SCD601-0940-2-2-140HA03-HP358	30802188
9,50	10	89	47	35	40	SCD601-0950-2-2-140HA03-HP358	30802190
9,60	10	89	47	35	40	SCD601-0960-2-2-140HA03-HP358	30802191
9,70	10	89	47	35	40	SCD601-0970-2-2-140HA03-HP358	30802192
9,80	10	89	47	35	40	SCD601-0980-2-2-140HA03-HP358	30802193
9,90	10	89	47	35	40	SCD601-0990-2-2-140HA03-HP358	30802194
10,00	10	89	47	35	40	SCD601-1000-2-2-140HA03-HP358	30802195
10,10	12	102	55	40	45	SCD601-1010-2-2-140HA03-HP358	30802196
10,20	12	102	55	40	45	SCD601-1020-2-2-140HA03-HP358	30802197
10,30	12	102	55	40	45	SCD601-1030-2-2-140HA03-HP358	30802198
10,40	12	102	55	40	45	SCD601-1040-2-2-140HA03-HP358	30802199
10,50	12	102	55	40	45	SCD601-1050-2-2-140HA03-HP358	30802200
10,55	12	102	55	40	45	SCD601-1055-2-2-140HA03-HP358	30802201
10,60	12	102	55	40	45	SCD601-1060-2-2-140HA03-HP358	30802202
10,70	12	102	55	40	45	SCD601-1070-2-2-140HA03-HP358	30802203

MEGA-Drill-Steel-Plus | Wiertło spiralne z węgla spiekane SCD601 (3xD), wewnętrzny dopływ środka chłodzącego

Wymiary						Typ chwytu HA	
d ₁ m7	d ₂ h6	l ₁	l ₂	l ₃	l ₄	Specyfikacja	Nr materiałowy
10,75	12	102	55	40	45	SCD601-1075-2-2-140HA03-HP358	30802204
10,80	12	102	55	40	45	SCD601-1080-2-2-140HA03-HP358	30802205
10,90	12	102	55	40	45	SCD601-1090-2-2-140HA03-HP358	30802206
11,00	12	102	55	40	45	SCD601-1100-2-2-140HA03-HP358	30802207
11,10	12	102	55	40	45	SCD601-1110-2-2-140HA03-HP358	30802208
11,20*	12	102	55	40	45	SCD601-1120-2-2-140HA03-HP358	30802209
11,25	12	102	55	40	45	SCD601-1125-2-2-140HA03-HP358	30802210
11,30	12	102	55	40	45	SCD601-1130-2-2-140HA03-HP358	30802211
11,45	12	102	55	40	45	SCD601-1145-2-2-140HA03-HP358	30802214
11,50	12	102	55	40	45	SCD601-1150-2-2-140HA03-HP358	30802215
11,60	12	102	55	40	45	SCD601-1160-2-2-140HA03-HP358	30802216
11,70	12	102	55	40	45	SCD601-1170-2-2-140HA03-HP358	30802217
11,80	12	102	55	40	45	SCD601-1180-2-2-140HA03-HP358	30802218
11,90	12	102	55	40	45	SCD601-1190-2-2-140HA03-HP358	30802219
12,00	12	102	55	40	45	SCD601-1200-2-2-140HA03-HP358	30802220
12,15	14	107	60	43	45	SCD601-1215-2-2-140HA03-HP358	30802221
12,20	14	107	60	43	45	SCD601-1220-2-2-140HA03-HP358	31307544
12,25	14	107	60	43	45	SCD601-1225-2-2-140HA03-HP358	30802222
12,50	14	107	60	43	45	SCD601-1250-2-2-140HA03-HP358	30802223
12,55	14	107	60	43	45	SCD601-1255-2-2-140HA03-HP358	30802224
12,70	14	107	60	43	45	SCD601-1270-2-2-140HA03-HP358	30802225
12,80	14	107	60	43	45	SCD601-1280-2-2-140HA03-HP358	30802226
12,90	14	107	60	43	45	SCD601-1290-2-2-140HA03-HP358	30802227
13,00	14	107	60	43	45	SCD601-1300-2-2-140HA03-HP358	30802228
13,10	14	107	60	43	45	SCD601-1310-2-2-140HA03-HP358	30802229
13,30	14	107	60	43	45	SCD601-1330-2-2-140HA03-HP358	30802230
13,35	14	107	60	43	45	SCD601-1335-2-2-140HA03-HP358	30802231
13,50	14	107	60	43	45	SCD601-1350-2-2-140HA03-HP358	30802232
13,70	14	107	60	43	45	SCD601-1370-2-2-140HA03-HP358	30802233
13,80	14	107	60	43	45	SCD601-1380-2-2-140HA03-HP358	30802234
14,00	14	107	60	43	45	SCD601-1400-2-2-140HA03-HP358	30802235
14,20	16	115	65	45	48	SCD601-1420-2-2-140HA03-HP358	30802236
14,50	16	115	65	45	48	SCD601-1450-2-2-140HA03-HP358	30802237
14,80	16	115	65	45	48	SCD601-1480-2-2-140HA03-HP358	30802238
15,00	16	115	65	45	48	SCD601-1500-2-2-140HA03-HP358	30802239
15,10	16	115	65	45	48	SCD601-1510-2-2-140HA03-HP358	30802240
15,25	16	115	65	45	48	SCD601-1525-2-2-140HA03-HP358	30802241
15,30	16	115	65	45	48	SCD601-1530-2-2-140HA03-HP358	30802242
15,35	16	115	65	45	48	SCD601-1535-2-2-140HA03-HP358	30802243
15,50	16	115	65	45	48	SCD601-1550-2-2-140HA03-HP358	30802244
15,60	16	115	65	45	48	SCD601-1560-2-2-140HA03-HP358	30802245
15,80	16	115	65	45	48	SCD601-1580-2-2-140HA03-HP358	30802246
16,00	16	115	65	45	48	SCD601-1600-2-2-140HA03-HP358	30802247
16,05	18	123	73	51	48	SCD601-1605-2-2-140HA03-HP358	30802248
16,50	18	123	73	51	48	SCD601-1650-2-2-140HA03-HP358	30802249
16,60	18	123	73	51	48	SCD601-1660-2-2-140HA03-HP358	31307545
16,90	18	123	73	51	48	SCD601-1690-2-2-140HA03-HP358	30802251
17,00	18	123	73	51	48	SCD601-1700-2-2-140HA03-HP358	30802252
17,50	18	123	73	51	48	SCD601-1750-2-2-140HA03-HP358	30802253
17,60	18	123	73	51	48	SCD601-1760-2-2-140HA03-HP358	30802254
17,80	18	123	73	51	48	SCD601-1780-2-2-140HA03-HP358	30802255
18,00	18	123	73	51	48	SCD601-1800-2-2-140HA03-HP358	30802256
18,50	20	131	79	55	50	SCD601-1850-2-2-140HA03-HP358	30802257
18,90	20	131	79	55	50	SCD601-1890-2-2-140HA03-HP358	30802259
19,00	20	131	79	55	50	SCD601-1900-2-2-140HA03-HP358	30802260
19,35	20	131	79	55	50	SCD601-1935-2-2-140HA03-HP358	30802261
19,50	20	131	79	55	50	SCD601-1950-2-2-140HA03-HP358	30802262

MEGA-Drill-Steel-Plus | Wiertło spiralne z węgliką spiekane SCD601 (3xD), wewnętrzny dopływ środka chłodzącego

Wymiary						Typ chwytu HA	
d ₁ m7	d ₂ h6	l ₁	l ₂	l ₃	l ₄	Specyfikacja	Nr materiałowy
19,80	20	131	79	55	50	SCD601-1980-2-2-140HA03-HP358	30802264
20,00	20	131	79	55	50	SCD601-2000-2-2-140HA03-HP358	30802265
21,00	25	151	93	66	56	SCD601-2100-2-2-140HA03-HP358	30802267
21,50	25	151	93	66	56	SCD601-2150-2-2-140HA03-HP358	30802268
22,00	25	151	93	66	56	SCD601-2200-2-2-140HA03-HP358	30802269
23,50	25	151	93	66	56	SCD601-2350-2-2-140HA03-HP358	30802272

Możliwość konfiguracji parametrów



Średnica:
możliwość wyboru średnicy w krokach
co 0,01 mm





Typ chwytu:
Typ chwytu: HB | HE

Specyfikacja:
SCD601-[średnica]-3-3-140[typ chwytu]03-HP358

Przykład:
SCD601-0431-3-3-140HE03-HP358

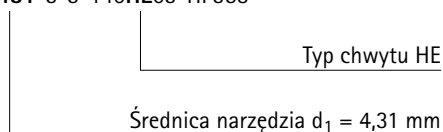

Wymiary typoszeregu z możliwością konfiguracji parametrów

d ₁ min.	d ₁ max.	d ₂ h6	l ₁	l ₂	l ₃	l ₄
3,00	3,70	6	62	20	14	36
3,71	4,70	6	66	24	17	36
4,71	6,00	6	66	28	20	36
6,01	7,00	8	79	34	24	36
7,01	8,00	8	79	41	29	36
8,01	10,00	10	89	47	35	40
10,01	12,00	12	102	55	40	45
12,01	14,00	14	107	60	43	45
14,01	16,00	16	115	65	45	48
16,01	18,00	18	123	73	51	48
18,01	20,00	20	131	79	55	50
20,01	25,00	25	151	93	66	56

Wymiary podano w mm.

* Nadaje się w szczególności do wiercenia otworów pod gwinty wykonywanych gniotownikami.

Zalecane parametry skrawania - patrz koniec rozdziału.

Wersje specjalne i inne powłoki wg zapytania ofertowego.

MEGA-Drill-Steel-Plus

Wiertła spiralne z węgla spiekane

SCD600 (5xD), zewnętrzne doprowadzenie chłodziwa, następcą MEGA-Drill-Steel (SCD10)

Wersja:

Średnica wiertła:	3,00 – 20,00 mm
Tolerancja otworu:	≥ IT 9
Materiał skrawający:	HP358
Liczba ostrzy:	2
Liczba łysinek:	2
Kąt wierzchołkowy:	140°
Kąt spirali:	30°

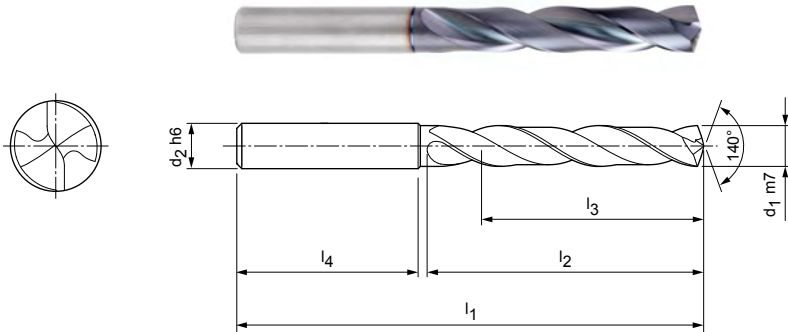

Magazynowa seria preferowana z typem chwytu HA

Wymiary						Typ chwytu HA	
d ₁ m7	d ₂ h6	l ₁	l ₂	l ₃	l ₄	Specyfikacja	Nr materiałowy
3,00	6	66	28	23	36	SCD600-0300-2-2-140HA05-HP358	30801634
3,10	6	66	28	23	36	SCD600-0310-2-2-140HA05-HP358	30801635
3,15	6	66	28	23	36	SCD600-0315-2-2-140HA05-HP358	30801636
3,20	6	66	28	23	36	SCD600-0320-2-2-140HA05-HP358	30801637
3,25	6	66	28	23	36	SCD600-0325-2-2-140HA05-HP358	30801639
3,30	6	66	28	23	36	SCD600-0330-2-2-140HA05-HP358	30801640
3,40	6	66	28	23	36	SCD600-0340-2-2-140HA05-HP358	30801641
3,50	6	66	28	23	36	SCD600-0350-2-2-140HA05-HP358	30801642
3,60	6	66	28	23	36	SCD600-0360-2-2-140HA05-HP358	30801643
3,70	6	66	28	23	36	SCD600-0370-2-2-140HA05-HP358	30801644
3,80	6	74	36	29	36	SCD600-0380-2-2-140HA05-HP358	30801645
3,90	6	74	36	29	36	SCD600-0390-2-2-140HA05-HP358	30801647
4,00	6	74	36	29	36	SCD600-0400-2-2-140HA05-HP358	30801648
4,10	6	74	36	29	36	SCD600-0410-2-2-140HA05-HP358	30801649
4,20	6	74	36	29	36	SCD600-0420-2-2-140HA05-HP358	30801650
4,25	6	74	36	29	36	SCD600-0425-2-2-140HA05-HP358	30801651
4,30	6	74	36	29	36	SCD600-0430-2-2-140HA05-HP358	30801652
4,35	6	74	36	29	36	SCD600-0435-2-2-140HA05-HP358	30801653
4,40	6	74	36	29	36	SCD600-0440-2-2-140HA05-HP358	30801654
4,50	6	74	36	29	36	SCD600-0450-2-2-140HA05-HP358	30801656
4,60	6	74	36	29	36	SCD600-0460-2-2-140HA05-HP358	30801657
4,65	6	74	36	29	36	SCD600-0465-2-2-140HA05-HP358	30801658
4,70	6	74	36	29	36	SCD600-0470-2-2-140HA05-HP358	30801659
4,80	6	82	44	35	36	SCD600-0480-2-2-140HA05-HP358	30801660
4,90	6	82	44	35	36	SCD600-0490-2-2-140HA05-HP358	30801662
4,95	6	82	44	35	36	SCD600-0495-2-2-140HA05-HP358	30801663
5,00	6	82	44	35	36	SCD600-0500-2-2-140HA05-HP358	30801664
5,05	6	82	44	35	36	SCD600-0505-2-2-140HA05-HP358	30801665
5,10	6	82	44	35	36	SCD600-0510-2-2-140HA05-HP358	30801666
5,20	6	82	44	35	36	SCD600-0520-2-2-140HA05-HP358	30801667
5,30	6	82	44	35	36	SCD600-0530-2-2-140HA05-HP358	30801668
5,40	6	82	44	35	36	SCD600-0540-2-2-140HA05-HP358	30801669
5,50	6	82	44	35	36	SCD600-0550-2-2-140HA05-HP358	30801670
5,55	6	82	44	35	36	SCD600-0555-2-2-140HA05-HP358	30801671
5,60	6	82	44	35	36	SCD600-0560-2-2-140HA05-HP358	30801672

MEGA-Drill-Steel-Plus | Wiertła spiralne z węgliką spiekane SCD600 (5xD), zewnętrzne doprowadzenie chłodziwa

Wymiary						Typ chwytu HA	
d ₁ m7	d ₂ h6	l ₁	l ₂	l ₃	l ₄	Specyfikacja	Nr materiałowy
5,70	6	82	44	35	36	SCD600-0570-2-2-140HA05-HP358	30801673
5,75	6	82	44	35	36	SCD600-0575-2-2-140HA05-HP358	30801674
5,80	6	82	44	35	36	SCD600-0580-2-2-140HA05-HP358	30801675
5,90	6	82	44	35	36	SCD600-0590-2-2-140HA05-HP358	30801676
5,95	6	82	44	35	36	SCD600-0595-2-2-140HA05-HP358	30801677
6,00	6	82	44	35	36	SCD600-0600-2-2-140HA05-HP358	30801678
6,10	8	91	53	43	36	SCD600-0610-2-2-140HA05-HP358	30801679
6,20	8	91	53	43	36	SCD600-0620-2-2-140HA05-HP358	30801680
6,30	8	91	53	43	36	SCD600-0630-2-2-140HA05-HP358	30801681
6,40	8	91	53	43	36	SCD600-0640-2-2-140HA05-HP358	30801682
6,50	8	91	53	43	36	SCD600-0650-2-2-140HA05-HP358	30801683
6,60	8	91	53	43	36	SCD600-0660-2-2-140HA05-HP358	30801684
6,70	8	91	53	43	36	SCD600-0670-2-2-140HA05-HP358	30801685
6,80	8	91	53	43	36	SCD600-0680-2-2-140HA05-HP358	30801686
6,90	8	91	53	43	36	SCD600-0690-2-2-140HA05-HP358	30801687
7,00	8	91	53	43	36	SCD600-0700-2-2-140HA05-HP358	30801688
7,10	8	91	53	43	36	SCD600-0710-2-2-140HA05-HP358	30801689
7,20	8	91	53	43	36	SCD600-0720-2-2-140HA05-HP358	30801690
7,30	8	91	53	43	36	SCD600-0730-2-2-140HA05-HP358	30801691
7,40	8	91	53	43	36	SCD600-0740-2-2-140HA05-HP358	30801692
7,45	8	91	53	43	36	SCD600-0745-2-2-140HA05-HP358	30801693
7,50	8	91	53	43	36	SCD600-0750-2-2-140HA05-HP358	30801694
7,60	8	91	53	43	36	SCD600-0760-2-2-140HA05-HP358	30801695
7,80	8	91	53	43	36	SCD600-0780-2-2-140HA05-HP358	30801697
7,90	8	91	53	43	36	SCD600-0790-2-2-140HA05-HP358	30801698
8,00	8	91	53	43	36	SCD600-0800-2-2-140HA05-HP358	30801699
8,10	10	103	61	49	40	SCD600-0810-2-2-140HA05-HP358	30801700
8,20	10	103	61	49	40	SCD600-0820-2-2-140HA05-HP358	30801701
8,30	10	103	61	49	40	SCD600-0830-2-2-140HA05-HP358	30801702
8,40	10	103	61	49	40	SCD600-0840-2-2-140HA05-HP358	30801703
8,50	10	103	61	49	40	SCD600-0850-2-2-140HA05-HP358	30801704
8,60	10	103	61	49	40	SCD600-0860-2-2-140HA05-HP358	30801705
8,70	10	103	61	49	40	SCD600-0870-2-2-140HA05-HP358	30801706
8,80	10	103	61	49	40	SCD600-0880-2-2-140HA05-HP358	30801707
8,90	10	103	61	49	40	SCD600-0890-2-2-140HA05-HP358	30801708
9,00	10	103	61	49	40	SCD600-0900-2-2-140HA05-HP358	30801709
9,10	10	103	61	49	40	SCD600-0910-2-2-140HA05-HP358	30801710
9,20	10	103	61	49	40	SCD600-0920-2-2-140HA05-HP358	30801711
9,30	10	103	61	49	40	SCD600-0930-2-2-140HA05-HP358	30801712
9,50	10	103	61	49	40	SCD600-0950-2-2-140HA05-HP358	30801716
9,60	10	103	61	49	40	SCD600-0960-2-2-140HA05-HP358	30801717
9,70	10	103	61	49	40	SCD600-0970-2-2-140HA05-HP358	30801718
9,80	10	103	61	49	40	SCD600-0980-2-2-140HA05-HP358	30801719
9,90	10	103	61	49	40	SCD600-0990-2-2-140HA05-HP358	30801720
10,00	10	103	61	49	40	SCD600-1000-2-2-140HA05-HP358	30801721
10,10	12	118	71	56	45	SCD600-1010-2-2-140HA05-HP358	30801722
10,20	12	118	71	56	45	SCD600-1020-2-2-140HA05-HP358	30801723
10,30	12	118	71	56	45	SCD600-1030-2-2-140HA05-HP358	30801724
10,40	12	118	71	56	45	SCD600-1040-2-2-140HA05-HP358	30801725
10,50	12	118	71	56	45	SCD600-1050-2-2-140HA05-HP358	30801726
10,70	12	118	71	56	45	SCD600-1070-2-2-140HA05-HP358	30801729
10,75	12	118	71	56	45	SCD600-1075-2-2-140HA05-HP358	30801731
10,80	12	118	71	56	45	SCD600-1080-2-2-140HA05-HP358	30801732
11,00	12	118	71	56	45	SCD600-1100-2-2-140HA05-HP358	30801734
11,20	12	118	71	56	45	SCD600-1120-2-2-140HA05-HP358	30801736
11,25	12	118	71	56	45	SCD600-1125-2-2-140HA05-HP358	30801737
11,30	12	118	71	56	45	SCD600-1130-2-2-140HA05-HP358	30801738

MEGA-Drill-Steel-Plus | Wiertła spiralne z węgliką spiekane SCD600 (5xD), zewnętrzne doprowadzenie chłodziwa

Wymiary						Typ chwytu HA	
d ₁ m7	d ₂ h6	l ₁	l ₂	l ₃	l ₄	Specyfikacja	Nr materiałowy
11,35	12	118	71	56	45	SCD600-1135-2-2-140HA05-HP358	30801739
11,50	12	118	71	56	45	SCD600-1150-2-2-140HA05-HP358	30801742
11,80	12	118	71	56	45	SCD600-1180-2-2-140HA05-HP358	30801745
11,90	12	118	71	56	45	SCD600-1190-2-2-140HA05-HP358	30801746
12,00	12	118	71	56	45	SCD600-1200-2-2-140HA05-HP358	30801747
12,15	14	124	77	60	45	SCD600-1215-2-2-140HA05-HP358	30801748
12,25	14	124	77	60	45	SCD600-1225-2-2-140HA05-HP358	30801749
12,50	14	124	77	60	45	SCD600-1250-2-2-140HA05-HP358	30801750
12,70	14	124	77	60	45	SCD600-1270-2-2-140HA05-HP358	30801752
12,80	14	124	77	60	45	SCD600-1280-2-2-140HA05-HP358	30801753
12,90	14	124	77	60	45	SCD600-1290-2-2-140HA05-HP358	30801754
13,00	14	124	77	60	45	SCD600-1300-2-2-140HA05-HP358	30801755
13,10	14	124	77	60	45	SCD600-1310-2-2-140HA05-HP358	30801756
13,30	14	124	77	60	45	SCD600-1330-2-2-140HA05-HP358	30801757
13,35	14	124	77	60	45	SCD600-1335-2-2-140HA05-HP358	30801758
13,50	14	124	77	60	45	SCD600-1350-2-2-140HA05-HP358	30801759
13,80	14	124	77	60	45	SCD600-1380-2-2-140HA05-HP358	30801761
14,00	14	124	77	60	45	SCD600-1400-2-2-140HA05-HP358	30801762
14,20	16	133	83	63	48	SCD600-1420-2-2-140HA05-HP358	30801763
14,50	16	133	83	63	48	SCD600-1450-2-2-140HA05-HP358	30801764
14,80	16	133	83	63	48	SCD600-1480-2-2-140HA05-HP358	30801765
15,00	16	133	83	63	48	SCD600-1500-2-2-140HA05-HP358	30801766
15,10	16	133	83	63	48	SCD600-1510-2-2-140HA05-HP358	30801767
15,25	16	133	83	63	48	SCD600-1525-2-2-140HA05-HP358	30801768
15,30	16	133	83	63	48	SCD600-1530-2-2-140HA05-HP358	30801769
15,50	16	133	83	63	48	SCD600-1550-2-2-140HA05-HP358	30801771
15,80	16	133	83	63	48	SCD600-1580-2-2-140HA05-HP358	30801773
16,00	16	133	83	63	48	SCD600-1600-2-2-140HA05-HP358	30801774
16,50	18	143	93	71	48	SCD600-1650-2-2-140HA05-HP358	30801776
16,80	18	143	93	71	48	SCD600-1680-2-2-140HA05-HP358	30801777
17,00	18	143	93	71	48	SCD600-1700-2-2-140HA05-HP358	30801779
17,50	18	143	93	71	48	SCD600-1750-2-2-140HA05-HP358	30801780
17,60	18	143	93	71	48	SCD600-1760-2-2-140HA05-HP358	30801781
18,00	18	143	93	71	48	SCD600-1800-2-2-140HA05-HP358	30801783
18,50	20	153	101	77	50	SCD600-1850-2-2-140HA05-HP358	30801784
18,80	20	153	101	77	50	SCD600-1880-2-2-140HA05-HP358	30801785
18,90	20	153	101	77	50	SCD600-1890-2-2-140HA05-HP358	30801786
19,00	20	153	101	77	50	SCD600-1900-2-2-140HA05-HP358	30801787
19,50	20	153	101	77	50	SCD600-1950-2-2-140HA05-HP358	30801789
19,80	20	153	101	77	50	SCD600-1980-2-2-140HA05-HP358	30801791
20,00	20	153	101	77	50	SCD600-2000-2-2-140HA05-HP358	30801792

Ciąg dalszy na następnej stronie.

MEGA-Drill-Steel-Plus | Wiertła spiralne z węgliku spiekane SCD600 (5xD), zewnętrzne doprowadzenie chłodziwa

Możliwość konfiguracji parametrów



Średnica:
możliwość wyboru średnicy w
krokach co 0,01 mm



Typ chwytu:
Typ chwytu: HB | HE

Specyfikacja:

SCD600-[średnica]-3-3-140[typ chwytu]05-HP358

Wymiary typoszeregu z możliwością konfiguracji parametrów

d ₁ min.	d ₁ max.	d ₂ h6	l ₁	l ₂	l ₃	l ₄
3,00	3,70	6	66	28	23	36
3,71	4,70	6	74	36	29	36
4,71	6,00	6	82	44	35	36
6,01	8,00	8	91	53	43	36
8,01	10,00	10	103	61	49	40
10,01	12,00	12	118	71	56	45
12,01	14,00	14	124	77	60	45
14,01	16,00	16	133	83	63	48
16,01	18,00	18	143	93	71	48
18,01	20,00	20	153	101	77	50

Przykład:

SCD600-0431-3-3-140HE05-HP358

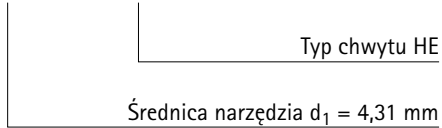

MEGA-Drill-Steel-Plus

Wiertła spiralne z węgla spiekane

SCD601 (5xD), wewnętrzne doprowadzenie chłodziwa, następcą MEGA-Drill-Steel (SCD10)

Wersja:

Średnica wiertła: 3,00 – 25,00 mm
 Tolerancja otworu: \geq IT 9
 Materiał skrawający: HP358
 Liczba ostrzy: 2
 Liczba tyśnek: 2
 Kąt wierzchołkowy: 140°
 Kąt spirali: 30°

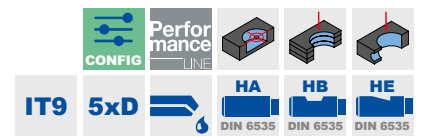
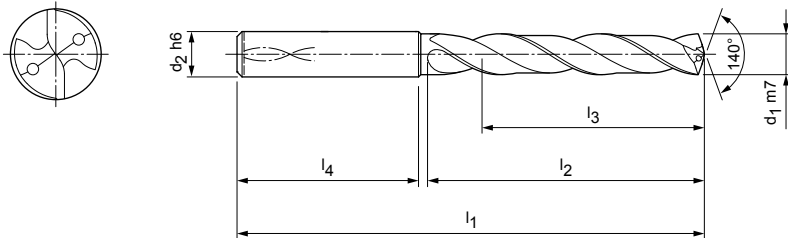

Magazynowa seria preferowana z typem chwytu HA

Wymiary						Typ chwytu HA	
d ₁ m7	d ₂ h6	l ₁	l ₂	l ₃	l ₄	Specyfikacja	Nr materiałowy
3,00	6	66	28	23	36	SCD601-0300-2-2-140HA05-HP358	30802611
3,10	6	66	28	23	36	SCD601-0310-2-2-140HA05-HP358	30802612
3,15	6	66	28	23	36	SCD601-0315-2-2-140HA05-HP358	30802613
3,20	6	66	28	23	36	SCD601-0320-2-2-140HA05-HP358	30802614
3,25	6	66	28	23	36	SCD601-0325-2-2-140HA05-HP358	30802616
3,30	6	66	28	23	36	SCD601-0330-2-2-140HA05-HP358	30802617
3,40	6	66	28	23	36	SCD601-0340-2-2-140HA05-HP358	30802618
3,50	6	66	28	23	36	SCD601-0350-2-2-140HA05-HP358	30802619
3,60	6	66	28	23	36	SCD601-0360-2-2-140HA05-HP358	30802620
3,65	6	66	28	23	36	SCD601-0365-2-2-140HA05-HP358	31307546
3,70*	6	66	28	23	36	SCD601-0370-2-2-140HA05-HP358	30802621
3,80	6	74	36	29	36	SCD601-0380-2-2-140HA05-HP358	30802622
3,85	6	74	36	29	36	SCD601-0385-2-2-140HA05-HP358	30802623
3,90	6	74	36	29	36	SCD601-0390-2-2-140HA05-HP358	30802624
4,00	6	74	36	29	36	SCD601-0400-2-2-140HA05-HP358	30802625
4,10	6	74	36	29	36	SCD601-0410-2-2-140HA05-HP358	30802626
4,20	6	74	36	29	36	SCD601-0420-2-2-140HA05-HP3583	30802627
4,25	6	74	36	29	36	SCD601-0425-2-2-140HA05-HP358	30802628
4,30	6	74	36	29	36	SCD601-0430-2-2-140HA05-HP358	30802629
4,35	6	74	36	29	36	SCD601-0435-2-2-140HA05-HP358	30802630
4,40	6	74	36	29	36	SCD601-0440-2-2-140HA05-HP358	30802631
4,45	6	74	36	29	36	SCD601-0445-2-2-140HA05-HP358	30802632
4,50	6	74	36	29	36	SCD601-0450-2-2-140HA05-HP358	30802633
4,60	6	74	36	29	36	SCD601-0460-2-2-140HA05-HP358	30802634
4,65*	6	74	36	29	36	SCD601-0465-2-2-140HA05-HP358	30802635
4,70	6	74	36	29	36	SCD601-0470-2-2-140HA05-HP358	30802636
4,80	6	82	44	35	36	SCD601-0480-2-2-140HA05-HP358	30802637
4,90	6	82	44	35	36	SCD601-0490-2-2-140HA05-HP358	30802638
4,95	6	82	44	35	36	SCD601-0495-2-2-140HA05-HP358	30802639
5,00	6	82	44	35	36	SCD601-0500-2-2-140HA05-HP358	30802640
5,05	6	82	44	35	36	SCD601-0505-2-2-140HA05-HP358	30802641
5,10	6	82	44	35	36	SCD601-0510-2-2-140HA05-HP358	30802642
5,20	6	82	44	35	36	SCD601-0520-2-2-140HA05-HP358	30802643
5,30	6	82	44	35	36	SCD601-0530-2-2-140HA05-HP358	30802644
5,40	6	82	44	35	36	SCD601-0540-2-2-140HA05-HP358	30802645

MEGA-Drill-Steel-Plus | wiertło spiralne z węglika spiekane SCD601 (5xD), wewnętrzny dopływ środka chłodzącego

Wymiary						Typ chwytu HA	
d ₁ m7	d ₂ h6	l ₁	l ₂	l ₃	l ₄	Specyfikacja	Nr materiałowy
5,50	6	82	44	35	36	SCD601-0550-2-2-140HA05-HP358	30802646
5,55*	6	82	44	35	36	SCD601-0555-2-2-140HA05-HP358	30802647
5,60	6	82	44	35	36	SCD601-0560-2-2-140HA05-HP358	30802648
5,70	6	82	44	35	36	SCD601-0570-2-2-140HA05-HP358	30802649
5,75	6	82	44	35	36	SCD601-0575-2-2-140HA05-HP358	30802650
5,80	6	82	44	35	36	SCD601-0580-2-2-140HA05-HP358	30802651
5,90	6	82	44	35	36	SCD601-0590-2-2-140HA05-HP358	30802652
5,95	6	82	44	35	36	SCD601-0595-2-2-140HA05-HP358	30802653
6,00	6	82	44	35	36	SCD601-0600-2-2-140HA05-HP358	30802654
6,10	8	91	53	43	36	SCD601-0610-2-2-140HA05-HP358	30802655
6,20	8	91	53	43	36	SCD601-0620-2-2-140HA05-HP358	30802656
6,30	8	91	53	43	36	SCD601-0630-2-2-140HA05-HP358	30802657
6,40	8	91	53	43	36	SCD601-0640-2-2-140HA05-HP358	30802658
6,50	8	91	53	43	36	SCD601-0650-2-2-140HA05-HP358	30802659
6,60	8	91	53	43	36	SCD601-0660-2-2-140HA05-HP358	30802660
6,70	8	91	53	43	36	SCD601-0670-2-2-140HA05-HP358	30802661
6,80	8	91	53	43	36	SCD601-0680-2-2-140HA05-HP358	30802662
6,90	8	91	53	43	36	SCD601-0690-2-2-140HA05-HP358	30802663
7,00	8	91	53	43	36	SCD601-0700-2-2-140HA05-HP358	30802664
7,10	8	91	53	43	36	SCD601-0710-2-2-140HA05-HP358	30802665
7,20	8	91	53	43	36	SCD601-0720-2-2-140HA05-HP358	30802666
7,30	8	91	53	43	36	SCD601-0730-2-2-140HA05-HP358	30802667
7,40	8	91	53	43	36	SCD601-0740-2-2-140HA05-HP358	30802668
7,45*	8	91	53	43	36	SCD601-0745-2-2-140HA05-HP358	30802669
7,50	8	91	53	43	36	SCD601-0750-2-2-140HA05-HP358	30802670
7,60	8	91	53	43	36	SCD601-0760-2-2-140HA05-HP358	30802671
7,70	8	91	53	43	36	SCD601-0770-2-2-140HA05-HP358	30802672
7,80	8	91	53	43	36	SCD601-0780-2-2-140HA05-HP358	30802673
7,90	8	91	53	43	36	SCD601-0790-2-2-140HA05-HP358	30802674
8,00	8	91	53	43	36	SCD601-0800-2-2-140HA05-HP358	30802675
8,10	10	103	61	49	40	SCD601-0810-2-2-140HA05-HP358	30802676
8,20	10	103	61	49	40	SCD601-0820-2-2-140HA05-HP358	30802677
8,30	10	103	61	49	40	SCD601-0830-2-2-140HA05-HP358	30802678
8,40	10	103	61	49	40	SCD601-0840-2-2-140HA05-HP358	30802679
8,50	10	103	61	49	40	SCD601-0850-2-2-140HA05-HP358	30802680
8,60	10	103	61	49	40	SCD601-0860-2-2-140HA05-HP358	30802681
8,70	10	103	61	49	40	SCD601-0870-2-2-140HA05-HP358	30802682
8,80	10	103	61	49	40	SCD601-0880-2-2-140HA05-HP358	30802683
8,90	10	103	61	49	40	SCD601-0890-2-2-140HA05-HP358	30802684
9,00	10	103	61	49	40	SCD601-0900-2-2-140HA05-HP358	30802685
9,10	10	103	61	49	40	SCD601-0910-2-2-140HA05-HP358	30802686
9,20	10	103	61	49	40	SCD601-0920-2-2-140HA05-HP358	30802687
9,30*	10	103	61	49	40	SCD601-0930-2-2-140HA05-HP358	30802688
9,35	10	103	61	49	40	SCD601-0935-2-2-140HA05-HP358	30802689
9,40	10	103	61	49	40	SCD601-0940-2-2-140HA05-HP358	30802690
9,45	10	103	61	49	40	SCD601-0945-2-2-140HA05-HP358	30802691
9,50	10	103	61	49	40	SCD601-0950-2-2-140HA05-HP358	30802692
9,60	10	103	61	49	40	SCD601-0960-2-2-140HA05-HP358	30802693
9,70	10	103	61	49	40	SCD601-0970-2-2-140HA05-HP358	30802694
9,80	10	103	61	49	40	SCD601-0980-2-2-140HA05-HP358	30802695
9,90	10	103	61	49	40	SCD601-0990-2-2-140HA05-HP358	30802696
10,00	10	103	61	49	40	SCD601-1000-2-2-140HA05-HP358	30802697
10,10	12	118	71	56	45	SCD601-1010-2-2-140HA05-HP358	30802698
10,20	12	118	71	56	45	SCD601-1020-2-2-140HA05-HP358	30802699
10,30	12	118	71	56	45	SCD601-1030-2-2-140HA05-HP358	30802700
10,40	12	118	71	56	45	SCD601-1040-2-2-140HA05-HP358	30802701
10,50	12	118	71	56	45	SCD601-1050-2-2-140HA05-HP358	30802702

MEGA-Drill-Steel-Plus | wiertło spiralne z węgla spiekane SCD601 (5xD), wewnętrzny dopływ środka chłodzącego

Wymiary						Typ chwytu HA	
d ₁ m7	d ₂ h6	l ₁	l ₂	l ₃	l ₄	Specyfikacja	Nr materiałowy
10,55	12	118	71	56	45	SCD601-1055-2-2-140HA05-HP358	30802703
10,60	12	118	71	56	45	SCD601-1060-2-2-140HA05-HP358	30802704
10,70	12	118	71	56	45	SCD601-1070-2-2-140HA05-HP358	30802705
10,80	12	118	71	56	45	SCD601-1080-2-2-140HA05-HP358	30802707
10,90	12	118	71	56	45	SCD601-1090-2-2-140HA05-HP358	30802708
11,00	12	118	71	56	45	SCD601-1100-2-2-140HA05-HP358	30802709
11,10	12	118	71	56	45	SCD601-1110-2-2-140HA05-HP358	30802710
11,20*	12	118	71	56	45	SCD601-1120-2-2-140HA05-HP358	30802711
11,25	12	118	71	56	45	SCD601-1125-2-2-140HA05-HP358	30802712
11,30	12	118	71	56	45	SCD601-1130-2-2-140HA05-HP358	30802713
11,40	12	118	71	56	45	SCD601-1140-2-2-140HA05-HP358	30802715
11,50	12	118	71	56	45	SCD601-1150-2-2-140HA05-HP358	30802717
11,60	12	118	71	56	45	SCD601-1160-2-2-140HA05-HP358	30802718
11,70	12	118	71	56	45	SCD601-1170-2-2-140HA05-HP358	30802719
11,80	12	118	71	56	45	SCD601-1180-2-2-140HA05-HP358	30802720
11,90	12	118	71	56	45	SCD601-1190-2-2-140HA05-HP358	30802721
12,00	12	118	71	56	45	SCD601-1200-2-2-140HA05-HP358	30802722
12,15	14	124	77	60	45	SCD601-1215-2-2-140HA05-HP358	30802723
12,25	14	124	77	60	45	SCD601-1225-2-2-140HA05-HP358	30802724
12,30	14	124	77	60	45	SCD601-1230-2-2-140HA05-HP358	31201193
12,50	14	124	77	60	45	SCD601-1250-2-2-140HA05-HP358	30802725
12,55	14	124	77	60	45	SCD601-1255-2-2-140HA05-HP358	30802726
12,70	14	124	77	60	45	SCD601-1270-2-2-140HA05-HP358	30802727
12,80	14	124	77	60	45	SCD601-1280-2-2-140HA05-HP358	30802728
12,90	14	124	77	60	45	SCD601-1290-2-2-140HA05-HP358	30802729
13,00	14	124	77	60	45	SCD601-1300-2-2-140HA05-HP358	30802730
13,10	14	124	77	60	45	SCD601-1310-2-2-140HA05-HP358	30802731
13,30	14	124	77	60	45	SCD601-1330-2-2-140HA05-HP358	30802732
13,35	14	124	77	60	45	SCD601-1335-2-2-140HA05-HP358	30802733
13,50	14	124	77	60	45	SCD601-1350-2-2-140HA05-HP358	30802734
13,70	14	124	77	60	45	SCD601-1370-2-2-140HA05-HP358	30802735
13,80	14	124	77	60	45	SCD601-1380-2-2-140HA05-HP358	30802736
14,00	14	124	77	60	45	SCD601-1400-2-2-140HA05-HP358	30802737
14,20	16	133	83	63	48	SCD601-1420-2-2-140HA05-HP358	30802738
14,50	16	133	83	63	48	SCD601-1450-2-2-140HA05-HP358	30802739
14,80	16	133	83	63	48	SCD601-1480-2-2-140HA05-HP358	30802740
15,00	16	133	83	63	48	SCD601-1500-2-2-140HA05-HP358	30802741
15,10	16	133	83	63	48	SCD601-1510-2-2-140HA05-HP358	30802742
15,25	16	133	83	63	48	SCD601-1525-2-2-140HA05-HP358	30802743
15,30	16	133	83	63	48	SCD601-1530-2-2-140HA05-HP358	30802744
15,35	16	133	83	63	48	SCD601-1535-2-2-140HA05-HP358	30802745
15,50	16	133	83	63	48	SCD601-1550-2-2-140HA05-HP358	30802746
15,60	16	133	83	63	48	SCD601-1560-2-2-140HA05-HP358	30802747
15,80	16	133	83	63	48	SCD601-1580-2-2-140HA05-HP358	30802748
16,00	16	133	83	63	48	SCD601-1600-2-2-140HA05-HP358	30802749
16,05	18	143	93	71	48	SCD601-1605-2-2-140HA05-HP358	30802750
16,50	18	143	93	71	48	SCD601-1650-2-2-140HA05-HP358	30802751
16,80	18	143	93	71	48	SCD601-1680-2-2-140HA05-HP358	30802752
16,90	18	143	93	71	48	SCD601-1690-2-2-140HA05-HP358	30802753
17,00	18	143	93	71	48	SCD601-1700-2-2-140HA05-HP358	30802754

Ciąg dalszy na następnej stronie.

MEGA-Drill-Steel-Plus | wiertło spiralne z węgla spiekane SCD601 (5xD), wewnętrzny dopływ środka chłodzącego

Możliwość konfiguracji parametrów



Średnica:
możliwość wyboru średnicy w krokach
co 0,01 mm



Typ chwytu:
Typ chwytu: HB | HE

Specyfikacja:

SCD601-[średnica]-3-3-140[typ chwytu]05-HP358

Przykład:

SCD601-0431-3-3-140HE05-HP358

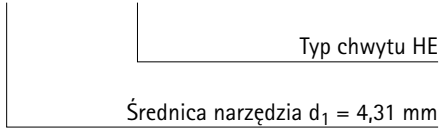

Wymiary typoszeregu z możliwością konfiguracji parametrów

d ₁ min.	d ₁ max.	d ₂ h6	l ₁	l ₂	l ₃	l ₄
3,00	3,70	6	66	28	23	36
3,71	4,70	6	74	36	29	36
4,71	6,00	6	82	44	35	36
6,01	8,00	8	91	53	43	36
8,01	10,00	10	103	61	49	40
10,01	12,00	12	118	71	56	45
12,01	14,00	14	124	77	60	45
14,01	16,00	16	133	83	63	48
16,01	18,00	18	143	93	71	48
18,01	20,00	20	153	101	77	50
20,01	22,00	25	200	135	110	56
22,01	25,00	25	200	140	120	56

Wymiary podano w mm.

* Nadaje się w szczególności do wiercenia otworów pod gwinty wykonywanych gniotownikami.

Zalecane parametry skrawania - patrz koniec rozdziału.

Wersje specjalne i inne powłoki wg zapytania ofertowego.

MEGA-Drill-Steel-Plus

Wiertła spiralne z węgla spiekane

SCD601 (8xD), wewnętrzne doprowadzenie chłodziwa, następcza MEGA-Drill-Steel (SCD10)

Wersja:

Średnica wiertła: 3,00 – 20,00 mm
 Tolerancja otworu: \geq IT 9
 Materiał skrawający: HP358
 Liczba ostrzy: 2
 Liczba łysinek: 2
 Kąt wierzchołkowy: 135°
 Kąt spirali: 30°

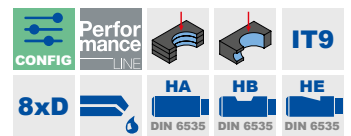
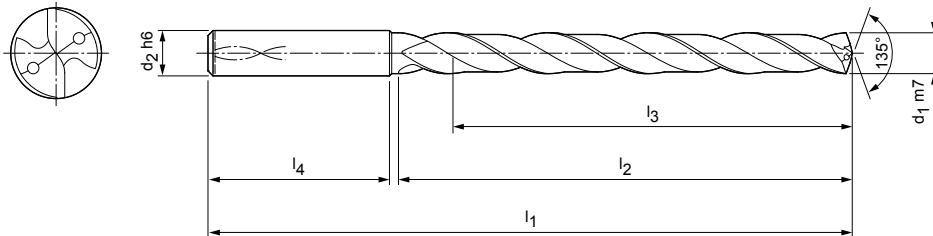

Magazynowa seria preferowana z typem chwytu HA

Wymiary						Typ chwytu HA	
d ₁ m7	d ₂ h6	l ₁	l ₂	l ₃	l ₄	Specyfikacja	Nr materiałowy
3,00	6	72	34	29	36	SCD601-0300-2-2-135HA08-HP358	30803112
3,10	6	72	34	29	36	SCD601-0310-2-2-135HA08-HP358	30803113
3,20	6	72	34	29	36	SCD601-0320-2-2-135HA08-HP358	30803114
3,30	6	72	34	29	36	SCD601-0330-2-2-135HA08-HP358	30803115
3,40	6	72	34	29	36	SCD601-0340-2-2-135HA08-HP358	30803116
3,50	6	72	34	29	36	SCD601-0350-2-2-135HA08-HP358	30803117
3,60	6	72	34	29	36	SCD601-0360-2-2-135HA08-HP358	30803118
3,70	6	72	34	29	36	SCD601-0370-2-2-135HA08-HP358	30803119
3,80	6	81	43	36	36	SCD601-0380-2-2-135HA08-HP358	30803120
3,90	6	81	43	36	36	SCD601-0390-2-2-135HA08-HP358	30803121
4,00	6	81	43	36	36	SCD601-0400-2-2-135HA08-HP358	30803122
4,10	6	81	43	36	36	SCD601-0410-2-2-135HA08-HP358	30803123
4,20	6	81	43	36	36	SCD601-0420-2-2-135HA08-HP358	30803124
4,30	6	81	43	36	36	SCD601-0430-2-2-135HA08-HP358	30803125
4,40	6	81	43	36	36	SCD601-0440-2-2-135HA08-HP358	30803126
4,50	6	81	43	36	36	SCD601-0450-2-2-135HA08-HP358	30803127
4,60	6	81	43	36	36	SCD601-0460-2-2-135HA08-HP358	30803128
4,70	6	81	43	36	36	SCD601-0470-2-2-135HA08-HP358	30803129
4,80	6	95	57	48	36	SCD601-0480-2-2-135HA08-HP358	30803130
4,90	6	95	57	48	36	SCD601-0490-2-2-135HA08-HP358	30803131
5,00	6	95	57	48	36	SCD601-0500-2-2-135HA08-HP358	30803132
5,10	6	95	57	48	36	SCD601-0510-2-2-135HA08-HP358	30803133
5,20	6	95	57	48	36	SCD601-0520-2-2-135HA08-HP358	30803134
5,30	6	95	57	48	36	SCD601-0530-2-2-135HA08-HP358	30803135
5,40	6	95	57	48	36	SCD601-0540-2-2-135HA08-HP358	30803136
5,50	6	95	57	48	36	SCD601-0550-2-2-135HA08-HP358	30803137
5,60	6	95	57	48	36	SCD601-0560-2-2-135HA08-HP358	30803138
5,70	6	95	57	48	36	SCD601-0570-2-2-135HA08-HP358	30803139
5,80	6	95	57	48	36	SCD601-0580-2-2-135HA08-HP358	30803140
5,90	6	95	57	48	36	SCD601-0590-2-2-135HA08-HP358	30803141
6,00	6	95	57	48	36	SCD601-0600-2-2-135HA08-HP358	30803142
6,10	8	114	76	64	36	SCD601-0610-2-2-135HA08-HP358	30803143
6,20	8	114	76	64	36	SCD601-0620-2-2-135HA08-HP358	30803144
6,30	8	114	76	64	36	SCD601-0630-2-2-135HA08-HP358	30803145
6,40	8	114	76	64	36	SCD601-0640-2-2-135HA08-HP358	30803146

MEGA-Drill-Steel-Plus | wiertło spiralne z węgliku spiekane SCD601 (8xD), wewnętrzny dopływ środka chłodzącego

Wymiary						Typ chwytu HA	
d ₁ m7	d ₂ h6	l ₁	l ₂	l ₃	l ₄	Specyfikacja	Nr materiałowy
6,50	8	114	76	64	36	SCD601-0650-2-2-135HA08-HP358	30803147
6,60	8	114	76	64	36	SCD601-0660-2-2-135HA08-HP358	30803148
6,70	8	114	76	64	36	SCD601-0670-2-2-135HA08-HP358	30803149
6,80	8	114	76	64	36	SCD601-0680-2-2-135HA08-HP358	30803150
6,90	8	114	76	64	36	SCD601-0690-2-2-135HA08-HP358	30803151
7,00	8	114	76	64	36	SCD601-0700-2-2-135HA08-HP358	30803152
7,10	8	114	76	64	36	SCD601-0710-2-2-135HA08-HP358	30803153
7,20	8	114	76	64	36	SCD601-0720-2-2-135HA08-HP358	30803154
7,30	8	114	76	64	36	SCD601-0730-2-2-135HA08-HP358	30803155
7,40	8	114	76	64	36	SCD601-0740-2-2-135HA08-HP358	30803156
7,50	8	114	76	64	36	SCD601-0750-2-2-135HA08-HP358	30803157
7,60	8	114	76	64	36	SCD601-0760-2-2-135HA08-HP358	30803158
7,70	8	114	76	64	36	SCD601-0770-2-2-135HA08-HP358	30803159
7,80	8	114	76	64	36	SCD601-0780-2-2-135HA08-HP358	30803160
7,90	8	114	76	64	36	SCD601-0790-2-2-135HA08-HP358	30803161
8,00	8	114	76	64	36	SCD601-0800-2-2-135HA08-HP358	30803162
8,10	10	142	95	80	40	SCD601-0810-2-2-135HA08-HP358	30803163
8,20	10	142	95	80	40	SCD601-0820-2-2-135HA08-HP358	30803164
8,40	10	142	95	80	40	SCD601-0840-2-2-135HA08-HP358	30803166
8,50	10	142	95	80	40	SCD601-0850-2-2-135HA08-HP358	30803167
8,60	10	142	95	80	40	SCD601-0860-2-2-135HA08-HP358	30803168
8,70	10	142	95	80	40	SCD601-0870-2-2-135HA08-HP358	30803169
8,80	10	142	95	80	40	SCD601-0880-2-2-135HA08-HP358	30803170
8,90	10	142	95	80	40	SCD601-0890-2-2-135HA08-HP358	30803171
9,00	10	142	95	80	40	SCD601-0900-2-2-135HA08-HP358	30803172
9,10	10	142	95	80	40	SCD601-0910-2-2-135HA08-HP358	30803173
9,20	10	142	95	80	40	SCD601-0920-2-2-135HA08-HP358	30803174
9,30	10	142	95	80	40	SCD601-0930-2-2-135HA08-HP358	30803175
9,40	10	142	95	80	40	SCD601-0940-2-2-135HA08-HP358	30803176
9,50	10	142	95	80	40	SCD601-0950-2-2-135HA08-HP358	30803177
9,60	10	142	95	80	40	SCD601-0960-2-2-135HA08-HP358	30803178
9,80	10	142	95	80	40	SCD601-0980-2-2-135HA08-HP358	30803180
9,90	10	142	95	80	40	SCD601-0990-2-2-135HA08-HP358	30803181
10,00	10	142	95	80	40	SCD601-1000-2-2-135HA08-HP358	30803182
10,10	12	162	114	96	45	SCD601-1010-2-2-135HA08-HP358	30803183
10,20	12	162	114	96	45	SCD601-1020-2-2-135HA08-HP358	30803184
10,30	12	162	114	95	45	SCD601-1030-2-2-135HA08-HP358	30803185
10,40	12	162	114	96	45	SCD601-1040-2-2-135HA08-HP358	30803186
10,50	12	162	114	96	45	SCD601-1050-2-2-135HA08-HP358	30803187
10,70	12	162	114	96	45	SCD601-1070-2-2-135HA08-HP358	30803189
10,80	12	162	114	96	45	SCD601-1080-2-2-135HA08-HP358	30803190
11,00	12	162	114	96	45	SCD601-1100-2-2-135HA08-HP358	30803192
11,10	12	162	114	96	45	SCD601-1110-2-2-135HA08-HP358	30803193
11,20	12	162	114	96	45	SCD601-1120-2-2-135HA08-HP358	30803194
11,30	12	162	114	96	45	SCD601-1130-2-2-135HA08-HP358	30803195
11,40	12	162	114	96	45	SCD601-1140-2-2-135HA08-HP358	30803196
11,50	12	162	114	96	45	SCD601-1150-2-2-135HA08-HP358	30803197
11,80	12	162	114	96	45	SCD601-1180-2-2-135HA08-HP358	30803200
12,00	12	162	114	96	45	SCD601-1200-2-2-135HA08-HP358	30803202
12,50	14	178	133	112	45	SCD601-1250-2-2-135HA08-HP358	30803203
12,80	14	178	133	112	45	SCD601-1280-2-2-135HA08-HP358	30803204
13,00	14	178	133	112	45	SCD601-1300-2-2-135HA08-HP358	30803205
13,50	14	178	133	112	45	SCD601-1350-2-2-135HA08-HP358	30803206
13,80	14	178	133	112	45	SCD601-1380-2-2-135HA08-HP358	30803207
14,00	14	178	133	112	45	SCD601-1400-2-2-135HA08-HP358	30803208
14,50	16	203	152	128	48	SCD601-1450-2-2-135HA08-HP358	30803209
14,80	16	203	152	128	48	SCD601-1480-2-2-135HA08-HP358	30803210

MEGA-Drill-Steel-Plus | wiertło spiralne z węgla spiekane SCD601 (8xD), wewnętrzny dopływ środka chłodzącego

Wymiary						Typ chwytu HA	
d ₁ m7	d ₂ h6	l ₁	l ₂	l ₃	l ₄	Specyfikacja	Nr materiałowy
15,00	16	203	152	128	48	SCD601-1500-2-2-135HA08-HP358	30803211
15,50	16	203	152	128	48	SCD601-1550-2-2-135HA08-HP358	30803212
15,80	16	203	152	128	48	SCD601-1580-2-2-135HA08-HP358	30803213
16,00	16	203	152	128	48	SCD601-1600-2-2-135HA08-HP358	30803214
17,00	18	222	171	144	48	SCD601-1700-2-2-135HA08-HP358	30803217
17,50	18	222	171	144	48	SCD601-1750-2-2-135HA08-HP358	30803218
17,80	18	222	171	144	48	SCD601-1780-2-2-135HA08-HP358	30803219
18,00	18	222	171	144	48	SCD601-1800-2-2-135HA08-HP358	30803220
18,50	20	243	190	160	50	SCD601-1850-2-2-135HA08-HP358	30803221
18,80	20	243	190	160	50	SCD601-1880-2-2-135HA08-HP358	30803222
19,50	20	243	190	160	50	SCD601-1950-2-2-135HA08-HP358	30803224
19,80	20	243	190	160	50	SCD601-1980-2-2-135HA08-HP358	30803225
20,00	20	243	190	160	50	SCD601-2000-2-2-135HA08-HP358	30803226

Możliwość konfiguracji parametrów



Średnica:
możliwość wyboru średnicy w krokach co 0,01 mm





Typ chwytu:
Typ chwytu: HB | HE

Specyfikacja:
SCD601-[średnica]-2-2-135[typ chwytu]08-HP358

Wymiary typoszeregu z możliwością konfiguracji parametrów

d ₁ min.	d ₁ max.	d ₂ h6	l ₁	l ₂	l ₃	l ₄
3,00	3,70	6	72	34	29	36
3,71	4,70	6	81	43	36	36
4,71	6,00	6	95	57	48	36
6,01	8,00	8	114	76	64	36
8,01	10,00	10	142	95	80	40
10,01	12,00	12	162	114	96	45
12,01	14,00	14	178	133	112	45
14,01	16,00	16	203	152	128	48
16,01	18,00	18	222	171	144	48
18,01	20,00	20	243	190	160	50

Przykład:

SCD601-0431-2-2-135HE08-HP358

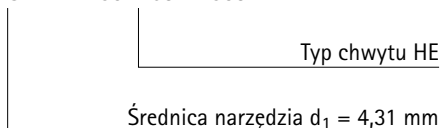

Wymiary podano w mm.

Zalecane parametry skrawania - patrz koniec rozdziału.

Wersje specjalne i inne powłoki wg zapytania ofertowego.

MEGA-Quadro-Drill-Plus

Wiertła spiralne z węgliku spiekanego

SCD610 (5xD), zewnętrzne doprowadzenie chłodziwa, następcą MEGA-Quadro-Drill (SCD16)

Wersja:

Średnica wiertła: 3,00 – 20,00 mm

Tolerancja otworu: \geq IT 8

Materiał skrawający: HP358

Liczba ostrzy: 2

Liczba łysinek: 4

Kąt wierzchołkowy: 140°

Kąt spirali: 30°

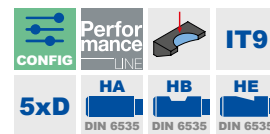
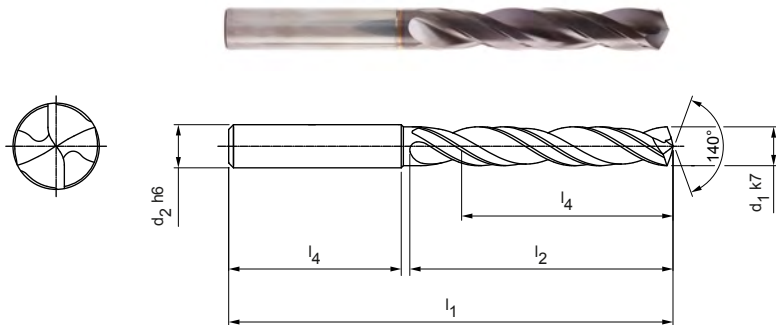

Magazynowa seria preferowana z typem chwytu HA

Wymiary						Typ chwytu HA	
d ₁ k7	d ₂ h6	l ₁	l ₂	l ₃	l ₄	Specyfikacja	Nr materiałowy
3,00	6	66	28	23	36	SCD610-0300-2-4-140HA05-HP358	31052631
3,10	6	66	28	23	36	SCD610-0310-2-4-140HA05-HP358	31052632
3,20	6	66	28	23	36	SCD610-0320-2-4-140HA05-HP358	31052633
3,30	6	66	28	23	36	SCD610-0330-2-4-140HA05-HP358	31052634
3,40	6	66	28	23	36	SCD610-0340-2-4-140HA05-HP358	31052635
3,50	6	66	28	23	36	SCD610-0350-2-4-140HA05-HP358	31052636
3,70	6	66	28	23	36	SCD610-0370-2-4-140HA05-HP358	31052638
4,00	6	74	36	29	36	SCD610-0400-2-4-140HA05-HP358	31052641
4,20	6	74	36	29	36	SCD610-0420-2-4-140HA05-HP358	31052643
4,30	6	74	36	29	36	SCD610-0430-2-4-140HA05-HP358	31052644
4,50	6	74	36	29	36	SCD610-0450-2-4-140HA05-HP358	31052646
4,80	6	82	44	35	36	SCD610-0480-2-4-140HA05-HP358	31052649
5,00	6	82	44	35	36	SCD610-0500-2-4-140HA05-HP358	31052651
5,10	6	82	44	35	36	SCD610-0510-2-4-140HA05-HP358	31052652
5,20	6	82	44	35	36	SCD610-0520-2-4-140HA05-HP358	31052653
5,50	6	82	44	35	36	SCD610-0550-2-4-140HA05-HP358	31052656
5,60	6	82	44	35	36	SCD610-0560-2-4-140HA05-HP358	31052657
5,80	6	82	44	35	36	SCD610-0580-2-4-140HA05-HP358	31052659
6,00	6	82	44	35	36	SCD610-0600-2-4-140HA05-HP358	31052661
6,40	8	91	53	43	36	SCD610-0640-2-4-140HA05-HP358	31052665
6,50	8	91	53	43	36	SCD610-0650-2-4-140HA05-HP358	31052666
6,80	8	91	53	43	36	SCD610-0680-2-4-140HA05-HP358	31052669
6,90	8	91	53	43	36	SCD610-0690-2-4-140HA05-HP358	31052670
7,00	8	91	53	43	36	SCD610-0700-2-4-140HA05-HP358	31052671
7,40	8	91	53	43	36	SCD610-0740-2-4-140HA05-HP358	31052675
7,50	8	91	53	43	36	SCD610-0750-2-4-140HA05-HP358	31052676
7,80	8	91	53	43	36	SCD610-0780-2-4-140HA05-HP358	31052679
8,00	8	91	53	43	36	SCD610-0800-2-4-140HA05-HP358	31052681
8,50	10	103	61	49	40	SCD610-0850-2-4-140HA05-HP358	31052686
8,60	10	103	61	49	40	SCD610-0860-2-4-140HA05-HP358	31052687
8,80	10	103	61	49	40	SCD610-0880-2-4-140HA05-HP358	31052689
9,00	10	103	61	49	40	SCD610-0900-2-4-140HA05-HP358	31052691
9,50	10	103	61	49	40	SCD610-0950-2-4-140HA05-HP358	31052696
9,80	10	103	61	49	40	SCD610-0980-2-4-140HA05-HP358	31052699
10,00	10	103	61	49	40	SCD610-1000-2-4-140HA05-HP358	31052701

MEGA-Quadro-Drill-Plus | Wiertła spiralne z węgla spiekane SCD610 (5xD), zewnętrzne doprowadzenie chłodziwa

Wymiary						Typ chwytu HA	
d ₁ k7	d ₂ h6	l ₁	l ₂	l ₃	l ₄	Specyfikacja	Nr materiałowy
10,20	12	118	71	56	45	SCD610-1020-2-4-140HA05-HP358	31052703
10,30	12	118	71	56	45	SCD610-1030-2-4-140HA05-HP358	31052704
10,50	12	118	71	56	45	SCD610-1050-2-4-140HA05-HP358	31052706
10,90	12	118	71	56	45	SCD610-1090-2-4-140HA05-HP358	31052710
11,00	12	118	71	56	45	SCD610-1100-2-4-140HA05-HP358	31052711
11,50	12	118	71	56	45	SCD610-1150-2-4-140HA05-HP358	31052716
11,80	12	118	71	56	45	SCD610-1180-2-4-140HA05-HP358	31052719
12,00	12	118	71	56	45	SCD610-1200-2-4-140HA05-HP358	31052721
12,50	14	124	77	60	45	SCD610-1250-2-4-140HA05-HP358	31052722
13,00	14	124	77	60	45	SCD610-1300-2-4-140HA05-HP358	31052724
13,50	14	124	77	60	45	SCD610-1350-2-4-140HA05-HP358	31052725
14,00	14	124	77	60	45	SCD610-1400-2-4-140HA05-HP358	31052727
14,50	16	133	83	63	48	SCD610-1450-2-4-140HA05-HP358	31052728
15,00	16	133	83	63	48	SCD610-1500-2-4-140HA05-HP358	31052730
16,00	16	133	83	63	48	SCD610-1600-2-4-140HA05-HP358	31052733
17,00	18	143	93	71	48	SCD610-1700-2-4-140HA05-HP358	31052736
17,50	18	143	93	71	48	SCD610-1750-2-4-140HA05-HP358	31052737
18,00	18	143	93	71	48	SCD610-1800-2-4-140HA05-HP358	31052739
18,50	20	153	101	77	50	SCD610-1850-2-4-140HA05-HP358	31052740
20,00	20	153	101	77	50	SCD610-2000-2-4-140HA05-HP358	31052745

Możliwość konfiguracji parametrów



Średnica:
możliwość wyboru średnicy w
krokach co 0,01 mm





Typ chwytu:
Typ chwytu: HB | HE

Specyfikacja:
SCD610-[średnica]-3-3-140[typ chwytu]05-HP358

Wymiary typoszeregu z możliwością konfiguracji parametrów

d ₁ min.	d ₁ max.	d ₂ h6	l ₁	l ₂	l ₃	l ₄
3,00	3,70	6	66	28	23	36
3,71	4,70	6	74	36	29	36
4,71	6,00	6	82	44	35	36
6,01	8,00	8	91	53	43	36
8,01	10,00	10	103	61	49	40
10,01	12,00	12	118	71	56	45
12,01	14,00	14	124	77	60	45
14,01	16,00	16	133	83	63	48
16,01	18,00	18	143	93	71	48
18,01	20,00	20	153	101	77	50

Przykład:

SCD610-0431-3-3-140HE05-HP358

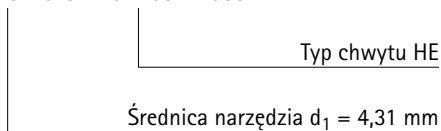

Wymiary podane w mm.

Zalecane dane techniczne dla narzędzi przeznaczonych do obróbki.

Specjalne sterowanie i inne podokreślenia są dostępne u producenta.

MEGA-Quadro-Drill-Plus

Wiertła spiralne z węglika spiekane

SCD611 (5xD), wewnętrzne doprowadzenie chłodziwa, następcą MEGA-Quadro-Drill (SCD16)

Wersja:

Średnica wiertła: 3,00 – 20,00 mm

Tolerancja otworu: \geq IT 8

Materiał skrawający: HP358

Liczba ostrzy: 2

Liczba łysinek: 4

Kąt wierzchołkowy: 140°

Kąt spirali: 30°

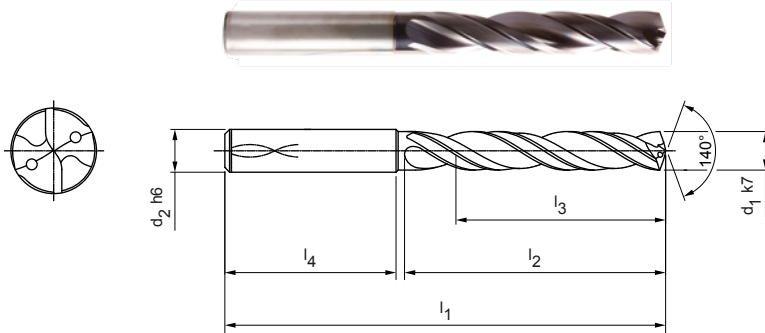

Magazynowa seria preferowana z typem chwytu HA

Wymiary						Typ chwytu HA	
d ₁ k7	d ₂ h6	l ₁	l ₂	l ₃	l ₄	Specyfikacja	Nr materiałowy
3,00	6	66	28	23	36	SCD611-0300-2-4-140HA05-HP358	31052795
3,10	6	66	28	23	36	SCD611-0310-2-4-140HA05-HP358	31052796
3,20	6	66	28	23	36	SCD611-0320-2-4-140HA05-HP358	31052797
3,30	6	66	28	23	36	SCD611-0330-2-4-140HA05-HP358	31052798
3,40	6	66	28	23	36	SCD611-0340-2-4-140HA05-HP358	31052799
3,50	6	66	28	23	36	SCD611-0350-2-4-140HA05-HP358	31052800
3,70	6	66	28	23	36	SCD611-0370-2-4-140HA05-HP358	31052802
3,80	6	74	36	29	36	SCD611-0380-2-4-140HA05-HP358	31052803
3,90	6	74	36	29	36	SCD611-0390-2-4-140HA05-HP358	31052804
4,00	6	74	36	29	36	SCD611-0400-2-4-140HA05-HP358	31052805
4,20	6	74	36	29	36	SCD611-0420-2-4-140HA05-HP358	31052807
4,30	6	74	36	29	36	SCD611-0430-2-4-140HA05-HP358	31052808
4,50	6	74	36	29	36	SCD611-0450-2-4-140HA05-HP358	31052810
4,80	6	82	44	35	36	SCD611-0480-2-4-140HA05-HP358	31052813
5,00	6	82	44	35	36	SCD611-0500-2-4-140HA05-HP358	31052815
5,10	6	82	44	35	36	SCD611-0510-2-4-140HA05-HP358	31052816
5,20	6	82	44	35	36	SCD611-0520-2-4-140HA05-HP358	31052817
5,30	6	82	44	35	36	SCD611-0530-2-4-140HA05-HP358	31052818
5,50	6	82	44	35	36	SCD611-0550-2-4-140HA05-HP358	31052820
5,60	6	82	44	35	36	SCD611-0560-2-4-140HA05-HP358	31052821
5,80	6	82	44	35	36	SCD611-0580-2-4-140HA05-HP358	31052823
5,90	6	82	44	35	36	SCD611-0590-2-4-140HA05-HP358	31052824
6,00	6	82	44	35	36	SCD611-0600-2-4-140HA05-HP358	31052825
6,40	8	91	53	43	36	SCD611-0640-2-4-140HA05-HP358	31052829
6,50	8	91	53	43	36	SCD611-0650-2-4-140HA05-HP358	31052830
6,60	8	91	53	43	36	SCD611-0660-2-4-140HA05-HP358	31052831
6,70	8	91	53	43	36	SCD611-0670-2-4-140HA05-HP358	31052832
6,80	8	91	53	43	36	SCD611-0680-2-4-140HA05-HP358	31052833
6,90	8	91	53	43	36	SCD611-0690-2-4-140HA05-HP358	31052834
7,00	8	91	53	43	36	SCD611-0700-2-4-140HA05-HP358	31052835
7,20	8	91	53	43	36	SCD611-0720-2-4-140HA05-HP358	31052837
7,40	8	91	53	43	36	SCD611-0740-2-4-140HA05-HP358	31052839
7,50	8	91	53	43	36	SCD611-0750-2-4-140HA05-HP358	31052840
7,80	8	91	53	43	36	SCD611-0780-2-4-140HA05-HP358	31052843
7,90	8	91	53	43	36	SCD611-0790-2-4-140HA05-HP358	31052844

MEGA-Quadro-Drill-Plus | Wiertła spiralne z węgla spiekane SCD611 (5xD), wewnętrzne doprowadzenie chłodziwa

Wymiary						Typ chwytu HA	
d ₁ k7	d ₂ h6	l ₁	l ₂	l ₃	l ₄	Specyfikacja	Nr materiałowy
8,00	8	91	53	43	36	SCD611-0800-2-4-140HA05-HP358	31052845
8,10	10	103	61	49	40	SCD611-0810-2-4-140HA05-HP358	31052846
8,30	10	103	61	49	40	SCD611-0830-2-4-140HA05-HP358	31052848
8,40	10	103	61	49	40	SCD611-0840-2-4-140HA05-HP358	31052849
8,50	10	103	61	49	40	SCD611-0850-2-4-140HA05-HP358	31052850
8,60	10	103	61	49	40	SCD611-0860-2-4-140HA05-HP358	31052851
8,80	10	103	61	49	40	SCD611-0880-2-4-140HA05-HP358	31052853
9,00	10	103	61	49	40	SCD611-0900-2-4-140HA05-HP358	31052855
9,20	10	103	61	49	40	SCD611-0920-2-4-140HA05-HP358	31052857
9,30	10	103	61	49	40	SCD611-0930-2-4-140HA05-HP358	31052858
9,50	10	103	61	49	40	SCD611-0950-2-4-140HA05-HP358	31052860
9,80	10	103	61	49	40	SCD611-0980-2-4-140HA05-HP358	31052863
9,90	10	103	61	49	40	SCD611-0990-2-4-140HA05-HP358	31052864
10,00	10	103	61	49	40	SCD611-1000-2-4-140HA05-HP358	31052865
10,20	12	118	71	56	45	SCD611-1020-2-4-140HA05-HP358	31052867
10,30	12	118	71	56	45	SCD611-1030-2-4-140HA05-HP358	31052868
10,40	12	118	71	56	45	SCD611-1040-2-4-140HA05-HP358	31052869
10,50	12	118	71	56	45	SCD611-1050-2-4-140HA05-HP358	31052870
10,90	12	118	71	56	45	SCD611-1090-2-4-140HA05-HP358	31052874
11,00	12	118	71	56	45	SCD611-1100-2-4-140HA05-HP358	31052875
11,50	12	118	71	56	45	SCD611-1150-2-4-140HA05-HP358	31052880
11,70	12	118	71	56	45	SCD611-1170-2-4-140HA05-HP358	31052882
11,80	12	118	71	56	45	SCD611-1180-2-4-140HA05-HP358	31052883

Możliwość konfiguracji parametrów



Średnica:
możliwość wyboru średnicy w krokach
co 0,01 mm





Typ chwytu:
Typ chwytu: HB | HE

Specyfikacja:
SCD611-[średnica]-3-3-140[typ chwytu]05-HP358

Wymiary typoszeroku z możliwością konfiguracji parametrów

d ₁ min.	d ₁ max.	d ₂ h6	l ₁	l ₂	l ₃	l ₄
3,00	3,70	6	66	28	23	36
3,71	4,70	6	74	36	29	36
4,71	6,00	6	82	44	35	36
6,01	8,00	8	91	53	43	36
8,01	10,00	10	103	61	49	40
10,01	12,00	12	118	71	56	45
12,01	14,00	14	124	77	60	45
14,01	16,00	16	133	83	63	48
16,01	18,00	18	143	93	71	48
18,01	20,00	20	153	101	77	50

Przykład:

SCD611-0431-3-3-140HE05-HP358

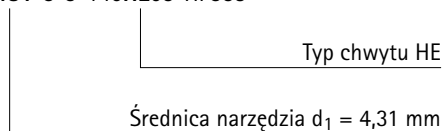

Wymiary podano w mm.

Zalecane parametry skrawania - patrz koniec rozdziału.

Wersje specjalne i inne powłoki wg zapytania ofertowego.

MEGA-Quadro-Drill-Plus

Wiertła spiralne z węgliku spiekane

SCD611 (8xD), wewnętrzne doprowadzenie chłodziwa, następcą MEGA-Quadro-Drill (SCD16)

Wersja:

Średnica wiertła:	3,00 – 20,00 mm
Tolerancja otworu:	≥ IT 8
Materiał skrawający:	HP358
Liczba ostrzy:	2
Liczba łysinek:	4
Kąt wierzchołkowy:	140°
Kąt spirali:	30°

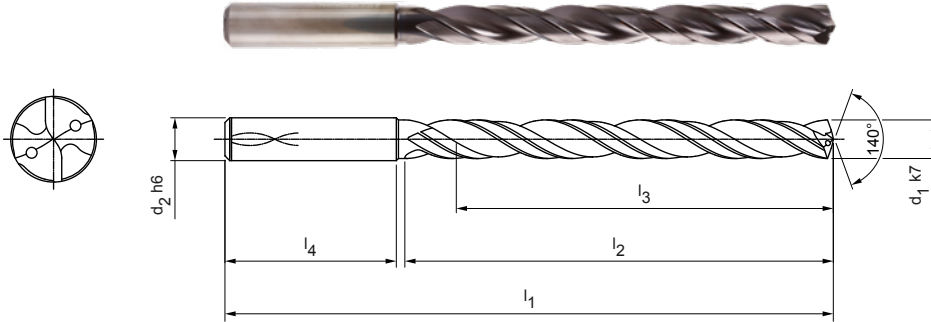

Magazynowa seria preferowana z typem chwytu HA

Wymiary						Typ chwytu HA	
d ₁ k7	d ₂ h6	l ₁	l ₂	l ₃	l ₄	Specyfikacja	Nr materiałowy
3,00	6	72	34	29	36	SCD611-0300-2-4-140HA08-HP358	31052910
3,10	6	72	34	29	36	SCD611-0310-2-4-140HA08-HP358	31052911
3,20	6	72	34	29	36	SCD611-0320-2-4-140HA08-HP358	31052912
3,30	6	72	34	29	36	SCD611-0330-2-4-140HA08-HP358	31052913
3,40	6	72	34	29	36	SCD611-0340-2-4-140HA08-HP358	31052914
3,50	6	72	34	29	36	SCD611-0350-2-4-140HA08-HP358	31052915
3,60	6	72	34	29	36	SCD611-0360-2-4-140HA08-HP358	31052916
3,70	6	72	34	29	36	SCD611-0370-2-4-140HA08-HP358	31052917
3,80	6	81	43	36	36	SCD611-0380-2-4-140HA08-HP358	31052918
3,90	6	81	43	36	36	SCD611-0390-2-4-140HA08-HP358	31052919
4,00	6	81	43	36	36	SCD611-0400-2-4-140HA08-HP358	31052920
4,10	6	81	43	36	36	SCD611-0410-2-4-140HA08-HP358	31052921
4,20	6	81	43	36	36	SCD611-0420-2-4-140HA08-HP358	31052922
4,30	6	81	43	36	36	SCD611-0430-2-4-140HA08-HP358	31052923
4,40	6	81	43	36	36	SCD611-0440-2-4-140HA08-HP358	31052924
4,50	6	81	43	36	36	SCD611-0450-2-4-140HA08-HP358	31052925
4,60	6	81	43	36	36	SCD611-0460-2-4-140HA08-HP358	31052926
4,80	6	95	57	48	36	SCD611-0480-2-4-140HA08-HP358	31052928
4,90	6	95	57	48	36	SCD611-0490-2-4-140HA08-HP358	31052929
5,00	6	95	57	48	36	SCD611-0500-2-4-140HA08-HP358	31052930
5,10	6	95	57	48	36	SCD611-0510-2-4-140HA08-HP358	31052931
5,20	6	95	57	48	36	SCD611-0520-2-4-140HA08-HP358	31052932
5,40	6	95	57	48	36	SCD611-0540-2-4-140HA08-HP358	31052934
5,50	6	95	57	48	36	SCD611-0550-2-4-140HA08-HP358	31052935
5,60	6	95	57	48	36	SCD611-0560-2-4-140HA08-HP358	31052936
5,70	6	95	57	48	36	SCD611-0570-2-4-140HA08-HP358	31052937
5,80	6	95	57	48	36	SCD611-0580-2-4-140HA08-HP358	31052938
6,00	6	95	57	48	36	SCD611-0600-2-4-140HA08-HP358	31052940
6,10	8	114	76	64	36	SCD611-0610-2-4-140HA08-HP358	31052941
6,20	8	114	76	64	36	SCD611-0620-2-4-140HA08-HP358	31052942
6,50	8	114	76	64	36	SCD611-0650-2-4-140HA08-HP358	31052945
6,60	8	114	76	64	36	SCD611-0660-2-4-140HA08-HP358	31052946
6,80	8	114	76	64	36	SCD611-0680-2-4-140HA08-HP358	31052948
6,90	8	114	76	64	36	SCD611-0690-2-4-140HA08-HP358	31052949
7,00	8	114	76	64	36	SCD611-0700-2-4-140HA08-HP358	31052950

MEGA-Quadro-Drill-Plus | Wiertła spiralne z węgla spiekane SCD611 (8xD), wewnętrzne doprowadzenie chłodziwa

Wymiary						Typ chwytu HA	
d ₁ k7	d ₂ h6	l ₁	l ₂	l ₃	l ₄	Specyfikacja	Nr materiałowy
7,20	8	114	76	64	36	SCD611-0720-2-4-140HA08-HP358	31052952
7,40	8	114	76	64	36	SCD611-0740-2-4-140HA08-HP358	31052954
7,50	8	114	76	64	36	SCD611-0750-2-4-140HA08-HP358	31052955
7,60	8	114	76	64	36	SCD611-0760-2-4-140HA08-HP358	31052956
7,80	8	114	76	64	36	SCD611-0780-2-4-140HA08-HP358	31052958
8,00	8	114	76	64	36	SCD611-0800-2-4-140HA08-HP358	31052960
8,20	10	142	95	80	40	SCD611-0820-2-4-140HA08-HP358	31052962
8,50	10	142	95	80	40	SCD611-0850-2-4-140HA08-HP358	31052965
8,60	10	142	95	80	40	SCD611-0860-2-4-140HA08-HP358	31052966
8,70	10	142	95	80	40	SCD611-0870-2-4-140HA08-HP358	31052967
8,90	10	142	95	80	40	SCD611-0890-2-4-140HA08-HP358	31052969
9,00	10	142	95	80	40	SCD611-0900-2-4-140HA08-HP358	31052970
9,50	10	142	95	80	40	SCD611-0950-2-4-140HA08-HP358	31052975
9,60	10	142	95	80	40	SCD611-0960-2-4-140HA08-HP358	31052976
9,70	10	142	95	80	40	SCD611-0970-2-4-140HA08-HP358	31052977
9,80	10	142	95	80	40	SCD611-0980-2-4-140HA08-HP358	31052978
9,90	10	142	95	80	40	SCD611-0990-2-4-140HA08-HP358	31052979
10,00	10	142	95	80	40	SCD611-1000-2-4-140HA08-HP358	31052980
10,10	12	162	114	96	45	SCD611-1010-2-4-140HA08-HP358	31052981
10,20	12	162	114	96	45	SCD611-1020-2-4-140HA08-HP358	31052982
10,50	12	162	114	96	45	SCD611-1050-2-4-140HA08-HP358	31052985
10,60	12	162	114	96	45	SCD611-1060-2-4-140HA08-HP358	31052986
10,70	12	162	114	96	45	SCD611-1070-2-4-140HA08-HP358	31052987
11,00	12	162	114	96	45	SCD611-1100-2-4-140HA08-HP358	31052990
11,30	12	162	114	96	45	SCD611-1130-2-4-140HA08-HP358	31052993
11,70	12	162	114	96	45	SCD611-1170-2-4-140HA08-HP358	31052997
11,80	12	162	114	96	45	SCD611-1180-2-4-140HA08-HP358	31052998
12,00	12	162	114	96	45	SCD611-1200-2-4-140HA08-HP358	31053000
12,50	14	178	133	112	45	SCD611-1250-2-4-140HA08-HP358	31053001
12,80	14	178	133	112	45	SCD611-1280-2-4-140HA08-HP358	31053002
13,00	14	178	133	112	45	SCD611-1300-2-4-140HA08-HP358	31053003
13,50	14	178	133	112	45	SCD611-1350-2-4-140HA08-HP358	31053004
14,00	14	178	133	112	45	SCD611-1400-2-4-140HA08-HP358	31053006
15,00	16	203	152	128	48	SCD611-1500-2-4-140HA08-HP358	31053009
15,80	16	203	152	128	48	SCD611-1580-2-4-140HA08-HP358	31053011
16,00	16	203	152	128	48	SCD611-1600-2-4-140HA08-HP358	31053012
16,50	18	222	171	144	48	SCD611-1650-2-4-140HA08-HP358	31053013
20,00	20	243	190	160	50	SCD611-2000-2-4-140HA08-HP358	31053024

Możliwość konfiguracji parametrów



Średnica:
możliwość wyboru średnicy w krokach co 0,01 mm





Typ chwytu:
Typ chwytu: HB | HE

Specyfikacja:
SCD611-[średnica]-3-3-140[typ chwytu]08-HP358

Wymiary typoszeregu z możliwością konfiguracji parametrów

d ₁ min.	d ₁ max.	d ₂ h6	l ₁	l ₂	l ₃	l ₄
3,00	3,70	6	72	34	29	36
3,71	4,70	6	81	43	36	36
4,71	6,00	6	95	57	48	36
6,01	8,00	8	114	76	64	36
8,01	10,00	10	142	95	80	40
10,01	12,00	12	162	114	96	45
12,01	14,00	14	178	133	112	45
14,01	16,00	16	203	152	128	48
16,01	18,00	18	222	171	144	48
18,01	20,00	20	243	190	160	50

Wymiary podano w mm.

Zalecane parametry skrawania - patrz koniec rozdziału.

Wersje specjalne i inne powłoki wg zapytania ofertowego.

Przykład:

SCD611-0431-2-4-140HE08-HP358

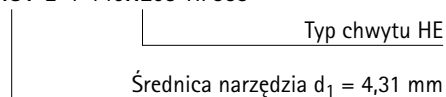

MEGA-Quadro-Drill-Plus

Wiertła spiralne z węgla spiekane

SCD611 (12xD), wewnętrzne doprowadzenie chłodziwa, następca MEGA-Quadro-Drill (SCD16)

Wersja:

Średnica wiertła: 3,00 – 20,00 mm

Tolerancja otworu: \geq IT 8

Materiał skrawający: HP358

Liczba ostrzy: 2

Liczba łysinek: 4

Kąt wierzchołkowy: 140°

Kąt spirali: 30°

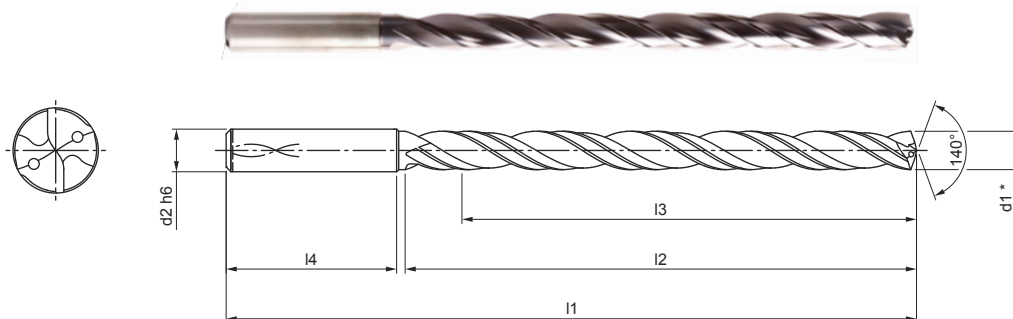

Magazynowa seria preferowana z typem chwytu HA

Wymiary						Typ chwytu HA	
d ₁ k7	d ₂ h6	l ₁	l ₂	l ₃	l ₄	Specyfikacja	Nr materiałowy
3,00	6	92	54	48	36	SCD611-0300-2-4-140HA12-HP358	31053025
3,10	6	92	54	48	36	SCD611-0310-2-4-140HA12-HP358	31053026
3,20	6	92	54	48	36	SCD611-0320-2-4-140HA12-HP358	31053027
3,30	6	92	54	48	36	SCD611-0330-2-4-140HA12-HP358	31053028
3,40	6	92	54	48	36	SCD611-0340-2-4-140HA12-HP358	31053029
3,50	6	92	54	48	36	SCD611-0350-2-4-140HA12-HP358	31053030
3,60	6	92	54	48	36	SCD611-0360-2-4-140HA12-HP358	31053031
3,70	6	92	54	48	36	SCD611-0370-2-4-140HA12-HP358	31053032
3,80	6	102	64	58	36	SCD611-0380-2-4-140HA12-HP358	31053033
3,90	6	102	64	58	36	SCD611-0390-2-4-140HA12-HP358	31053034
4,00	6	102	64	58	36	SCD611-0400-2-4-140HA12-HP358	31053035
4,05	6	102	64	58	36	SCD611-0405-2-4-140HA12-HP358	31300718
4,10	6	102	64	58	36	SCD611-0410-2-4-140HA12-HP358	31053036
4,20	6	102	64	58	36	SCD611-0420-2-4-140HA12-HP358	31053037
4,30	6	102	64	58	36	SCD611-0430-2-4-140HA12-HP358	31053038
4,40	6	102	64	58	36	SCD611-0440-2-4-140HA12-HP358	31053039
4,50	6	102	64	58	36	SCD611-0450-2-4-140HA12-HP358	31053040
4,60	6	102	64	58	36	SCD611-0460-2-4-140HA12-HP358	31053041
4,65	6	116	78	58	36	SCD611-0465-2-4-140HA12-HP358	31179333
4,70	6	102	64	58	36	SCD611-0470-2-4-140HA12-HP358	31053042
4,80	6	116	78	70	36	SCD611-0480-2-4-140HA12-HP358	31053043
5,00	6	116	78	70	36	SCD611-0500-2-4-140HA12-HP358	31053045
5,05	6	116	78	70	36	SCD611-0505-2-4-140HA12-HP358	31245107
5,10	6	116	78	70	36	SCD611-0510-2-4-140HA12-HP358	31053046
5,20	6	116	78	70	36	SCD611-0520-2-4-140HA12-HP358	31053047
5,40	6	116	78	70	36	SCD611-0540-2-4-140HA12-HP358	31053049
5,50	6	116	78	70	36	SCD611-0550-2-4-140HA12-HP358	31053050
5,60	6	116	78	70	36	SCD611-0560-2-4-140HA12-HP358	31053051
5,70	6	116	78	70	36	SCD611-0570-2-4-140HA12-HP358	31053052
5,80	6	116	78	70	36	SCD611-0580-2-4-140HA12-HP358	31053053
6,00	6	116	78	70	36	SCD611-0600-2-4-140HA12-HP358	31053055
6,10	8	146	108	94	36	SCD611-0610-2-4-140HA12-HP358	31053056
6,40	8	146	108	94	36	SCD611-0640-2-4-140HA12-HP358	31053059
6,50	8	146	108	94	36	SCD611-0650-2-4-140HA12-HP358	31053060
6,80	8	146	108	94	36	SCD611-0680-2-4-140HA12-HP358	31053063

MEGA-Quadro-Drill-Plus | Wiertła spiralne z węgla spiekane SCD611 (12xD), wewnętrzne doprowadzenie chłodziwa

Wymiary						Typ chwytu HA	
d ₁ k7	d ₂ h6	l ₁	l ₂	l ₃	l ₄	Specyfikacja	Nr materiałowy
6,90	8	146	108	94	36	SCD611-0690-2-4-140HA12-HP358	31053064
7,00	8	146	108	94	36	SCD611-0700-2-4-140HA12-HP358	31053065
7,10	8	146	108	94	36	SCD611-0710-2-4-140HA12-HP358	31053066
7,50	8	146	108	94	36	SCD611-0750-2-4-140HA12-HP358	31053070
7,60	8	146	108	94	36	SCD611-0760-2-4-140HA12-HP358	31053071
7,70	8	146	108	94	36	SCD611-0770-2-4-140HA12-HP358	31053072
7,80	8	146	108	94	36	SCD611-0780-2-4-140HA12-HP358	31053073
7,90	8	146	108	94	36	SCD611-0790-2-4-140HA12-HP358	31053074
8,00	8	146	108	94	36	SCD611-0800-2-4-140HA12-HP358	31053075
8,20	10	162	120	110	40	SCD611-0820-2-4-140HA12-HP358	31053077
8,30	10	162	120	110	40	SCD611-0830-2-4-140HA12-HP358	31053078
8,40	10	162	120	110	40	SCD611-0840-2-4-140HA12-HP358	31053079
8,50	10	162	120	110	40	SCD611-0850-2-4-140HA12-HP358	31053080
8,60	10	162	120	110	40	SCD611-0860-2-4-140HA12-HP358	31053081
8,70	10	162	120	110	40	SCD611-0870-2-4-140HA12-HP358	31053082
9,00	10	162	120	110	40	SCD611-0900-2-4-140HA12-HP358	31053085
9,50	10	162	120	110	40	SCD611-0950-2-4-140HA12-HP358	31053090
9,60	10	162	120	110	40	SCD611-0960-2-4-140HA12-HP358	31053091
9,80	10	162	120	110	40	SCD611-0980-2-4-140HA12-HP358	31053093
9,90	10	162	120	110	40	SCD611-0990-2-4-140HA12-HP358	31053094
10,00	10	162	120	110	40	SCD611-1000-2-4-140HA12-HP358	31053095
10,20	12	204	156	142	45	SCD611-1020-2-4-140HA12-HP358	31053097
10,50	12	204	156	142	45	SCD611-1050-2-4-140HA12-HP358	31053100
10,60	12	204	156	142	45	SCD611-1060-2-4-140HA12-HP358	31053101
11,00	12	204	156	142	45	SCD611-1100-2-4-140HA12-HP358	31053105
11,20	12	204	156	142	45	SCD611-1120-2-4-140HA12-HP358	31053107
11,70	12	204	156	142	45	SCD611-1170-2-4-140HA12-HP358	31053112
11,80	12	204	156	142	45	SCD611-1180-2-4-140HA12-HP358	31053113
12,00	12	204	156	142	45	SCD611-1200-2-4-140HA12-HP358	31053115
12,50	14	230	182	166	45	SCD611-1250-2-4-140HA12-HP358	31053116
13,00	14	230	182	166	45	SCD611-1300-2-4-140HA12-HP358	31053118
13,50	14	230	182	166	45	SCD611-1350-2-4-140HA12-HP358	31053119
14,00	14	230	182	166	45	SCD611-1400-2-4-140HA12-HP358	31053121
14,50	16	260	208	192	48	SCD611-1450-2-4-140HA12-HP358	31053122
15,00	16	260	208	192	48	SCD611-1500-2-4-140HA12-HP358	31053124
16,00	16	260	208	192	48	SCD611-1600-2-4-140HA12-HP358	31053127
16,50	18	285	234	216	48	SCD611-1650-2-4-140HA12-HP358	31053128
17,50	18	285	234	216	48	SCD611-1750-2-4-140HA12-HP358	31053131
19,50	20	310	258	240	50	SCD611-1950-2-4-140HA12-HP358	31053137

Ciąg dalszy na następnej stronie.

MEGA-Quadro-Drill-Plus | Wiertła spiralne z węgla spiekane SCD611 (12xD), wewnętrzne doprowadzenie chłodziwa

Możliwość konfiguracji parametrów



Średnica:
możliwość wyboru średnicy w krokach
co 0,01 mm



Typ chwytu:
Typ chwytu: HB | HE

Specyfikacja:

SCD611-[średnica]-2-4-140[typ chwytu]12-HP358

Wymiary typoszeregu z możliwością konfiguracji parametrów

d ₁ min.	d ₁ max.	d ₂ h6	l ₁	l ₂	l ₃	l ₄
3,00	3,70	6	92	54	48	36
3,71	4,70	6	102	64	58	36
4,71	6,00	6	116	78	70	36
6,01	8,00	8	146	108	94	36
8,01	10,00	10	162	120	110	40
10,01	12,00	12	204	156	142	45
12,01	14,00	14	230	182	166	45
14,01	16,00	16	260	208	192	48
16,01	18,00	18	285	234	216	48
18,01	20,00	20	310	258	240	50

Przykład:

SCD611-0431-2-4-140HE12-HP358

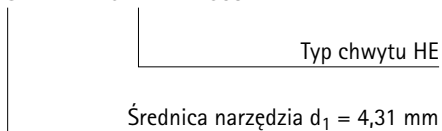

MICRO-Drill-Steel

Wiertła spiralne z węglika spiekane
SCD371 (5xD), wewnętrzne doprowadzenie chłodziwa

Wersja:
Średnica wiertła: 0,80 – 2,99 mm
Tolerancja otworu: IT9 (osiągalna)
Materiał skrawający: HP246
Liczba ostrzy: 2
Liczba łysinek: 4
Kąt wierzchołkowy: 142°
Kąt spirali: 30°

Zastosowanie:
Wiertło pilotujące, dostosowane do MEGA-Deep-Drill
Maksymalny zakres zastosowania do < średnicy 3,00 mm.

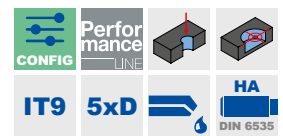
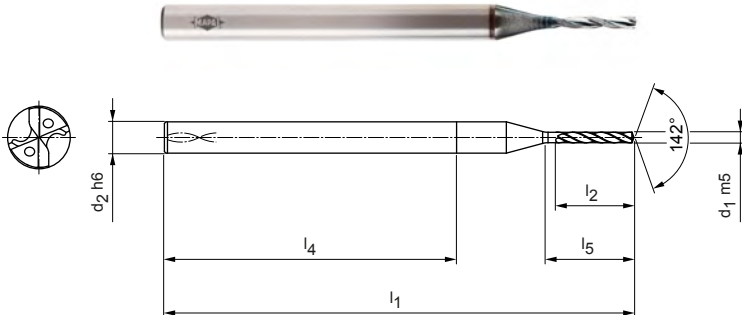

Magazynowa seria preferowana z typem chwytu HA

Wymiary						Typ chwytu HA	
d ₁ m5	d ₂ h6	l ₁	l ₂	l ₃	l ₄	Specyfikacja	Nr materiałowy
0,80	3	45	6	4	28	SCD371-0080-2-4-142HA05-HP246	31238823
1,00	3	45	7,5	5	28	SCD371-0100-2-4-142HA05-HP246	31238825
1,20	3	45	9	6	28	SCD371-0120-2-4-142HA05-HP246	31238827
1,50	3	45	11,3	7,5	28	SCD371-0150-2-4-142HA05-HP246	31238890
1,60	3	50	12	8	28	SCD371-0160-2-4-142HA05-HP246	31238891
2,00	3	50	15	10	28	SCD371-0200-2-4-142HA05-HP246	31238895
2,40	3	52	18	12	28	SCD371-0240-2-4-142HA05-HP246	31238899
2,50	3	52	18,8	12,5	28	SCD371-0250-2-4-142HA05-HP246	31238900
2,60	3	55	19,5	13	28	SCD371-0260-2-4-142HA05-HP246	31238901
2,80	3	55	21	14	28	SCD371-0280-2-4-142HA05-HP246	31238903

Możliwość konfiguracji parametrów

Średnica:
możliwość wyboru średnicy w krokach co 0,01 mm

Specyfikacja:
SCD371-[średnica]-2-4-142HA05-HP246

Wymiary typoszeregu z możliwością konfiguracji parametrów

d ₁ min.	d ₁ max.	d ₂ h6	l ₁	l ₂	l ₃	l ₄
0,80	0,99	3	45	6,0	4,0	28
1,00	1,29	3	45	7,5	5,0	28
1,30	1,59	3	45	9,8	6,5	28
1,60	1,89	3	50	12,0	8,0	28
1,90	2,19	3	50	14,3	9,5	28
2,20	2,59	3	52	16,5	11,0	28
2,60	2,99	3	55	19,5	13,0	28

Przykład:
SCD371-0221-2-4-142HA05-HP246

Średnica narzędzia d₁ = 2,21 mm

Wymiary podano w mm.
Zalecane parametry skrawania - patrz koniec rozdziału.
Wersje specjalne i inne powłoki wg zapytania ofertowego.

MICRO-Drill-Steel

Wiertła spiralne z węgla spiekane
SCD371 (8xD), wewnętrzne doprowadzenie chłodziwa

Wersja:

Średnica wiertła: 1,00 – 2,99 mm
Tolerancja otworu: IT9 (osiągalna)
Materiał skrawający: HP246
Liczba ostrzy: 2
Liczba łysinek: 4
Kąt wierzchołkowy: 142°
Kąt spirali: 30°

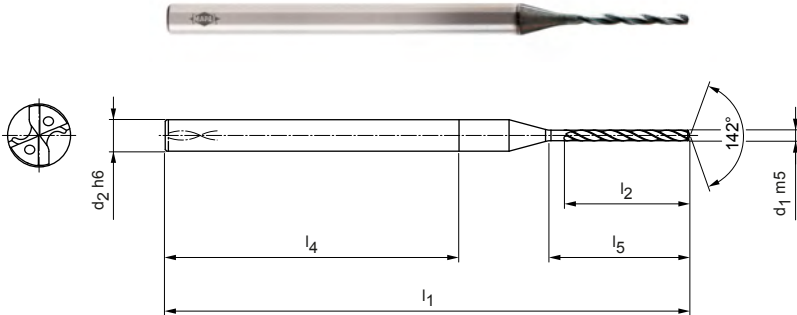

Magazynowa seria preferowana z typem chwytu HA

Wymiary						Typ chwytu HA	
d ₁ m5	d ₂ h6	l ₁	l ₂	l ₃	l ₄	Specyfikacja	Nr materiałowy
1,00	3	50	12	8	28	SCD371-0100-2-4-142HA08-HP246	31238905
1,20	3	50	14,4	9,6	28	SCD371-0120-2-4-142HA08-HP246	31238907
1,50	3	52	18	12	28	SCD371-0150-2-4-142HA08-HP246	31238910
1,60	3	55	19,2	12,8	28	SCD371-0160-2-4-142HA08-HP246	31238911
2,00	3	60	24	16	28	SCD371-0200-2-4-142HA08-HP246	31238915
2,50	3	62	30	20	28	SCD371-0250-2-4-142HA08-HP246	31238920

Możliwość konfiguracji parametrów



Średnica:
możliwość wyboru średnicy w krokach co 0,01 mm

Specyfikacja:
SCD371-[średnica]-2-4-142HA08-HP246

Wymiary typoszeregu z możliwością konfiguracji parametrów

d ₁ min.	d ₁ max.	d ₂ h6	l ₁	l ₂	l ₃	l ₄
1,00	1,29	3	50	12,0	8,0	28
1,30	1,59	3	52	15,6	10,4	28
1,60	1,89	3	55	19,2	12,8	28
1,90	2,19	3	60	22,8	15,2	28
2,20	2,59	3	62	26,4	17,6	28
2,60	2,99	3	66	31,2	20,8	28

Przykład:

SCD371-0221-2-4-142HA08-HP246

Średnica narzędzia d₁ = 2,21 mm

Wymiary podano w mm.

Zalecane parametry skrawania - patrz koniec rozdziału.

Wersje specjalne i inne powłoki wg zapytania ofertowego.

MICRO-Drill-Steel

Wiertła spiralne z węgla spiekanego
SCD371 (12xD), wewnętrzne doprowadzenie chłodziwa

Wersja:
Średnica wiertła: 1,00 – 2,99 mm
Tolerancja otworu: IT9 (osiągalna)
Materiał skrawający: HP246
Liczba ostrzy: 2
Liczba łysinek: 4
Kąt wierzchołkowy: 142°
Kąt spirali: 30°

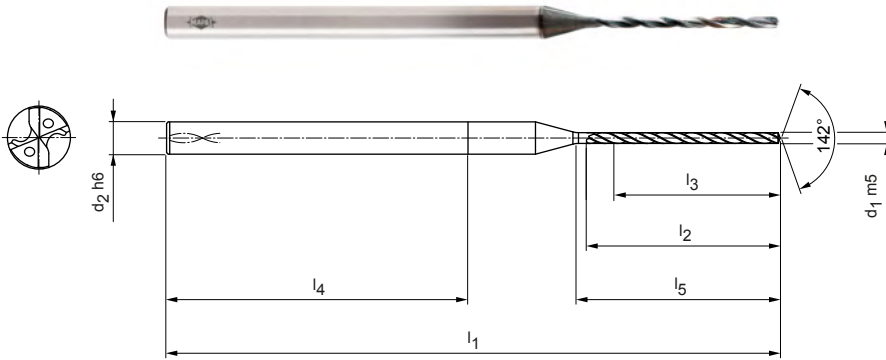

Magazynowa seria preferowana z typem chwytu HA

Wymiary						Typ chwytu HA	
d ₁ m5	d ₂ h6	l ₁	l ₂	l ₃	l ₄	Specyfikacja	Nr materiałowy
1,00	3	57	18	12	28	SCD371-0100-2-4-142HA12-HP246	31238925
1,20	3	57	21,6	14,4	28	SCD371-0120-2-4-142HA12-HP246	31238927
1,30	3	62	23,4	15,6	28	SCD371-0130-2-4-142HA12-HP246	31238928
1,50	3	62	27	18	28	SCD371-0150-2-4-142HA12-HP246	31238930
2,00	3	72	36	24	28	SCD371-0200-2-4-142HA12-HP246	31238935
2,50	3	79	45	30	28	SCD371-0250-2-4-142HA12-HP246	31238940

Możliwość konfiguracji parametrów

Średnica:
możliwość wyboru średnicy w krokach co 0,01 mm

Specyfikacja:
SCD371-[średnica]-2-4-142HA12-HP246

Wymiary typoszeregu z możliwością konfiguracji parametrów

d ₁ min.	d ₁ max.	d ₂ h6	l ₁	l ₂	l ₃	l ₄
1,00	1,29	3	57	18,0	12,0	28
1,30	1,59	3	62	23,4	15,6	28
1,60	1,89	3	66	28,8	19,2	28
1,90	2,19	3	72	34,2	22,8	28
2,20	2,59	3	79	39,6	26,4	28
2,60	2,99	3	85	46,8	31,2	28

Przykład:
SCD371-0221-2-4-142HA12-HP246

Średnica narzędzia d₁ = 2,21 mm

Wymiary podano w mm.
Zalecane parametry skrawania - patrz koniec rozdziału.
Wersje specjalne i inne powłoki wg zapytania ofertowego.

MEGA-Drill-Hardened

Wiertła spiralne z węgla spiekanego
SCD140 (3xD)

Wersja:

Średnica wiertła: 2,55 – 20,00 mm
Tolerancja otworu: IT 9 (osiągalne)
Materiał skrawający: HP809
Liczba ostrzy: 2
Liczba łysinek: 2
Kąt wierzchołkowy: 140°
Kąt spirali: 15°

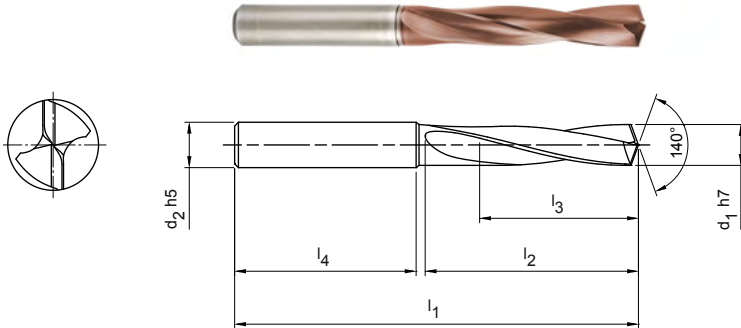

Magazynowa seria preferowana z typem chwytu HA

Wymiary						Typ chwytu HA	
d ₁ h7	d ₂ h5	l ₁	l ₂	l ₃	l ₄	Specyfikacja	Nr materiałowy
2,55	6	62	20	14	36	SCD140-0255-2-2-140HA03-HP809	31198190
2,60	6	62	20	14	36	SCD140-0260-2-2-140HA03-HP809	31198191
2,70	6	62	20	14	36	SCD140-0270-2-2-140HA03-HP809	31198192
2,80	6	62	20	14	36	SCD140-0280-2-2-140HA03-HP809	31198194
2,90	6	62	20	14	36	SCD140-0290-2-2-140HA03-HP809	31198196
3,00	6	62	20	14	36	SCD140-0300-2-2-140HA03-HP809	31151191
3,10	6	62	20	14	36	SCD140-0310-2-2-140HA03-HP809	31151192
3,20	6	62	20	14	36	SCD140-0320-2-2-140HA03-HP809	31151193
3,30	6	62	20	14	36	SCD140-0330-2-2-140HA03-HP809	31151194
3,40	6	62	20	14	36	SCD140-0340-2-2-140HA03-HP809	31151195
3,50	6	62	20	14	36	SCD140-0350-2-2-140HA03-HP809	31151196
3,60	6	62	20	14	36	SCD140-0360-2-2-140HA03-HP809	31151197
3,70	6	62	20	14	36	SCD140-0370-2-2-140HA03-HP809	31151198
3,80	6	66	24	17	36	SCD140-0380-2-2-140HA03-HP809	31151199
3,90	6	66	24	17	36	SCD140-0390-2-2-140HA03-HP809	31151330
4,00	6	66	24	17	36	SCD140-0400-2-2-140HA03-HP809	31151331
4,10	6	66	24	17	36	SCD140-0410-2-2-140HA03-HP809	31151332
4,20	6	66	24	17	36	SCD140-0420-2-2-140HA03-HP809	31151333
4,30	6	66	24	17	36	SCD140-0430-2-2-140HA03-HP809	31151334
4,40	6	66	24	17	36	SCD140-0440-2-2-140HA03-HP809	31151335
4,50	6	66	24	17	36	SCD140-0450-2-2-140HA03-HP809	31151336
4,60	6	66	24	17	36	SCD140-0460-2-2-140HA03-HP809	31151337
4,70	6	66	24	17	36	SCD140-0470-2-2-140HA03-HP809	31151339
4,80	6	66	28	20	36	SCD140-0480-2-2-140HA03-HP809	31151340
4,90	6	66	28	20	36	SCD140-0490-2-2-140HA03-HP809	31151341
5,00	6	66	28	20	36	SCD140-0500-2-2-140HA03-HP809	31151342
5,10	6	66	28	20	36	SCD140-0510-2-2-140HA03-HP809	31151343
5,20	6	66	28	20	36	SCD140-0520-2-2-140HA03-HP809	31151344
5,30	6	66	28	20	36	SCD140-0530-2-2-140HA03-HP809	31151345
5,40	6	66	28	20	36	SCD140-0540-2-2-140HA03-HP809	31151346
5,50	6	66	28	20	36	SCD140-0550-2-2-140HA03-HP809	31151347
5,55	6	66	28	20	36	SCD140-0555-2-2-140HA03-HP809	31151348
5,60	6	66	28	20	36	SCD140-0560-2-2-140HA03-HP809	31151349
5,70	6	66	28	20	36	SCD140-0570-2-2-140HA03-HP809	31151350
5,80	6	66	28	20	36	SCD140-0580-2-2-140HA03-HP809	31151351

MEGA-Drill-Hardened | Wiertło spiralne z węgla spiekane SCD140 (3xD)

Wymiary						Typ chwytu HA	
d ₁ h7	d ₂ h5	l ₁	l ₂	l ₃	l ₄	Specyfikacja	Nr materiałowy
5,90	6	66	28	20	36	SCD140-0590-2-2-140HA03-HP809	31151352
6,00	6	66	28	20	36	SCD140-0600-2-2-140HA03-HP809	31151353
6,10	8	79	34	24	36	SCD140-0610-2-2-140HA03-HP809	31151354
6,20	8	79	34	24	36	SCD140-0620-2-2-140HA03-HP809	31151355
6,30	8	79	34	24	36	SCD140-0630-2-2-140HA03-HP809	31151356
6,40	8	79	34	24	36	SCD140-0640-2-2-140HA03-HP809	31151357
6,50	8	79	34	24	36	SCD140-0650-2-2-140HA03-HP809	31151358
6,60	8	79	34	24	36	SCD140-0660-2-2-140HA03-HP809	31151359
6,70	8	79	34	24	36	SCD140-0670-2-2-140HA03-HP809	31151360
6,80	8	79	34	24	36	SCD140-0680-2-2-140HA03-HP809	31151361
6,90	8	79	34	24	36	SCD140-0690-2-2-140HA03-HP809	31151362
7,00	8	79	34	24	36	SCD140-0700-2-2-140HA03-HP809	31151363
7,10	8	79	41	29	36	SCD140-0710-2-2-140HA03-HP809	31151364
7,30	8	79	41	29	36	SCD140-0730-2-2-140HA03-HP809	31151366
7,40	8	79	41	29	36	SCD140-0740-2-2-140HA03-HP809	31151367
7,50	8	79	41	29	36	SCD140-0750-2-2-140HA03-HP809	31151368
7,80	8	79	41	29	36	SCD140-0780-2-2-140HA03-HP809	31151371
7,90	8	79	41	29	36	SCD140-0790-2-2-140HA03-HP809	31151372
8,00	8	79	41	29	36	SCD140-0800-2-2-140HA03-HP809	31151373
8,10	10	89	47	35	40	SCD140-0810-2-2-140HA03-HP809	31151374
8,20	10	89	47	35	40	SCD140-0820-2-2-140HA03-HP809	31151375
8,50	10	89	47	35	40	SCD140-0850-2-2-140HA03-HP809	31151378
8,60	10	89	47	35	40	SCD140-0860-2-2-140HA03-HP809	31151379
8,80	10	89	47	35	40	SCD140-0880-2-2-140HA03-HP809	31151381
9,00	10	89	47	35	40	SCD140-0900-2-2-140HA03-HP809	31151383
9,30	10	89	47	35	40	SCD140-0930-2-2-140HA03-HP809	31151386
9,50	10	89	47	35	40	SCD140-0950-2-2-140HA03-HP809	31151388
9,60	10	89	47	35	40	SCD140-0960-2-2-140HA03-HP809	31151389
9,70	10	89	47	35	40	SCD140-0970-2-2-140HA03-HP809	31151390
9,80	10	89	47	35	40	SCD140-0980-2-2-140HA03-HP809	31151391
10,00	10	89	47	35	40	SCD140-1000-2-2-140HA03-HP809	31151393
10,10	12	102	55	40	45	SCD140-1010-2-2-140HA03-HP809	31151394
10,20	12	102	55	40	45	SCD140-1020-2-2-140HA03-HP809	31151395
10,30	12	102	55	40	45	SCD140-1030-2-2-140HA03-HP809	31151396
10,40	12	102	55	40	45	SCD140-1040-2-2-140HA03-HP809	31151397
10,50	12	102	55	40	45	SCD140-1050-2-2-140HA03-HP809	31151398
11,00	12	102	55	40	45	SCD140-1100-2-2-140HA03-HP809	31151403
11,50	12	102	55	40	45	SCD140-1150-2-2-140HA03-HP809	31151408
11,80	12	102	55	40	45	SCD140-1180-2-2-140HA03-HP809	31151411
11,90	12	102	55	40	45	SCD140-1190-2-2-140HA03-HP809	31151412
12,00	12	102	55	40	45	SCD140-1200-2-2-140HA03-HP809	31151413
12,50	14	107	60	43	45	SCD140-1250-2-2-140HA03-HP809	31151415
12,80	14	107	60	43	45	SCD140-1280-2-2-140HA03-HP809	31151416
13,00	14	107	60	43	45	SCD140-1300-2-2-140HA03-HP809	31151417
13,50	14	107	60	43	45	SCD140-1350-2-2-140HA03-HP809	31151418
14,00	14	107	60	43	45	SCD140-1400-2-2-140HA03-HP809	31151420
14,20	16	115	65	45	48	SCD140-1420-2-2-140HA03-HP809	31151421
14,50	16	115	65	45	48	SCD140-1450-2-2-140HA03-HP809	31151422
14,80	16	115	65	45	48	SCD140-1480-2-2-140HA03-HP809	31151423
15,00	16	115	65	45	48	SCD140-1500-2-2-140HA03-HP809	31151424
15,50	16	115	65	45	48	SCD140-1550-2-2-140HA03-HP809	31151426
16,00	16	115	65	45	48	SCD140-1600-2-2-140HA03-HP809	31151428
17,50	18	123	73	51	48	SCD140-1750-2-2-140HA03-HP809	31151432

Ciąg dalszy na następnej stronie.

MEGA-Drill-Hardened | Wiertło spiralne z węgla spiekane SCD140 (3xD)

Możliwość konfiguracji parametrów



Średnica:
możliwość wyboru średnicy w
krokach co 0,01 mm



Typ chwytu:
Typ chwytu: HB | HE

Specyfikacja:

SCD140-[średnica]-2-2-140[typ chwytu]03-HP809

Przykład:

SCD140-0431-2-2-140HE03-HP809

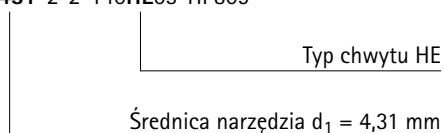

Wymiary typoszeregu z możliwością konfiguracji parametrów

d ₁ min.	d ₁ max.	d ₂ h6	l ₁	l ₂	l ₃	l ₄
2,55	3,79	6	62	20	14	36
3,80	4,79	6	66	24	17	36
4,80	6,00	6	66	28	20	36
6,01	7,00	8	79	34	24	36
7,01	8,00	8	79	41	29	36
8,01	10,00	10	89	47	35	40
10,01	12,00	12	102	55	40	45
12,01	14,00	14	107	60	43	45
14,01	16,00	16	115	65	45	48
16,01	18,00	18	123	73	51	48
18,01	20,00	20	131	79	55	50

Wymiary podano w mm.

Zalecane parametry skrawania - patrz koniec rozdziału.

Wersje specjalne i inne powłoki wg zapytania ofertowego.

Tritan-Drill-Steel

Wiertła spiralne z węgla spiekane
SCD661 (3xD), wewnętrzne doprowadzenie chłodziwa

Wersja:

Średnica wiertła: 4,00 – 20,00 mm
Tolerancja otworu: ≥ IT 9
Materiał skrawający: HP358
Liczba ostrzy: 3
Liczba łysinek: 3
Kąt wierzchołkowy: 145°
Kąt spirali: 30°

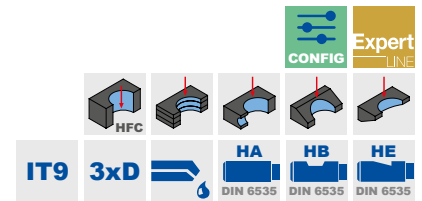
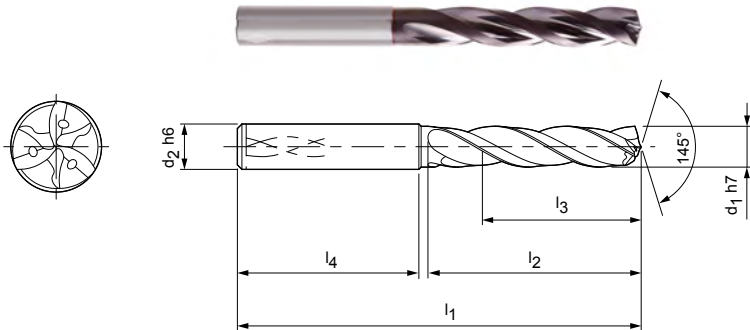

Magazynowa seria preferowana z typem chwytu HA

Wymiary						Typ chwytu HA	
d ₁ h7	d ₂ h6	l ₁	l ₂	l ₃	l ₄	Specyfikacja	Nr materiałowy
4,00	6	66	24	17	36	SCD661-0400-3-3-145HA03-HP358	30902036
4,10	6	66	24	17	36	SCD661-0410-3-3-145HA03-HP358	30902037
4,20	6	66	24	17	36	SCD661-0420-3-3-145HA03-HP358	30902038
4,30	6	66	24	17	36	SCD661-0430-3-3-145HA03-HP358	30902039
4,40	6	66	24	17	36	SCD661-0440-3-3-145HA03-HP358	30902040
4,50	6	66	24	17	36	SCD661-0450-3-3-145HA03-HP358	30902041
4,60	6	66	24	17	36	SCD661-0460-3-3-145HA03-HP358	30902042
4,65	6	66	24	17	36	SCD661-0465-3-3-145HA03-HP358	30902043
4,70	6	66	24	17	36	SCD661-0470-3-3-145HA03-HP358	30902044
4,80	6	66	28	20	36	SCD661-0480-3-3-145HA03-HP358	30902045
4,90	6	66	28	20	36	SCD661-0490-3-3-145HA03-HP358	30902046
5,00	6	66	28	20	36	SCD661-0500-3-3-145HA03-HP358	30902047
5,10	6	66	28	20	36	SCD661-0510-3-3-145HA03-HP358	30902048
5,20	6	66	28	20	36	SCD661-0520-3-3-145HA03-HP358	30902049
5,30	6	66	28	20	36	SCD661-0530-3-3-145HA03-HP358	30902050
5,40	6	66	28	20	36	SCD661-0540-3-3-145HA03-HP358	30902051
5,50	6	66	28	20	36	SCD661-0550-3-3-145HA03-HP358	30902052
5,55	6	66	28	20	36	SCD661-0555-3-3-145HA03-HP358	30902053
5,60	6	66	28	20	36	SCD661-0560-3-3-145HA03-HP358	30902054
5,70	6	66	28	20	36	SCD661-0570-3-3-145HA03-HP358	30902055
5,80	6	66	28	20	36	SCD661-0580-3-3-145HA03-HP358	30902056
5,90	6	66	28	20	36	SCD661-0590-3-3-145HA03-HP358	30902057
6,00	6	66	28	20	36	SCD661-0600-3-3-145HA03-HP358	30902058
6,10	8	79	34	24	36	SCD661-0610-3-3-145HA03-HP358	30902059
6,20	8	79	34	24	36	SCD661-0620-3-3-145HA03-HP358	30902060
6,30	8	79	34	24	36	SCD661-0630-3-3-145HA03-HP358	30902061
6,35	8	79	34	24	36	SCD661-0635-3-3-145HA03-HP358	31307522
6,40	8	79	34	24	36	SCD661-0640-3-3-145HA03-HP358	30902062
6,50	8	79	34	24	36	SCD661-0650-3-3-145HA03-HP358	30902063
6,60	8	79	34	24	36	SCD661-0660-3-3-145HA03-HP358	30902064
6,70	8	79	34	24	36	SCD661-0670-3-3-145HA03-HP358	30902065
6,80	8	79	34	24	36	SCD661-0680-3-3-145HA03-HP358	30902066
6,90	8	79	34	24	36	SCD661-0690-3-3-145HA03-HP358	30902067
7,00	8	79	34	24	36	SCD661-0700-3-3-145HA03-HP358	30902068
7,10	8	79	41	29	36	SCD661-0710-3-3-145HA03-HP358	30902069

Tritan-Drill-Steel | Wiertło spiralne z węgla spiekane SCD661 (3xD), wewnętrzne doprowadzenie chłodziwa

Wymiary						Typ chwytu HA	
d ₁ h7	d ₂ h6	l ₁	l ₂	l ₃	l ₄	Specyfikacja	Nr materiałowy
7,20	8	79	41	29	36	SCD661-0720-3-3-145HA03-HP358	30902070
7,30	8	79	41	29	36	SCD661-0730-3-3-145HA03-HP358	30902071
7,40	8	79	41	29	36	SCD661-0740-3-3-145HA03-HP358	30902072
7,45	8	79	41	29	36	SCD661-0745-3-3-145HA03-HP358	30902073
7,50	8	79	41	29	36	SCD661-0750-3-3-145HA03-HP358	30902074
7,60	8	79	41	29	36	SCD661-0760-3-3-145HA03-HP358	30902075
7,70	8	79	41	29	36	SCD661-0770-3-3-145HA03-HP358	30902076
7,80	8	79	41	29	36	SCD661-0780-3-3-145HA03-HP358	30902077
7,90	8	79	41	29	36	SCD661-0790-3-3-145HA03-HP358	30902078
8,00	8	79	41	29	36	SCD661-0800-3-3-145HA03-HP358	30902079
8,10	10	89	47	35	40	SCD661-0810-3-3-145HA03-HP358	30902080
8,20	10	89	47	35	40	SCD661-0820-3-3-145HA03-HP358	30902081
8,30	10	89	47	35	40	SCD661-0830-3-3-145HA03-HP358	30902082
8,40	10	89	47	35	40	SCD661-0840-3-3-145HA03-HP358	30902083
8,50	10	89	47	35	40	SCD661-0850-3-3-145HA03-HP358	30902084
8,60	10	89	47	35	40	SCD661-0860-3-3-145HA03-HP358	30902085
8,70	10	89	47	35	40	SCD661-0870-3-3-145HA03-HP358	30902086
8,80	10	89	47	35	40	SCD661-0880-3-3-145HA03-HP358	30902087
9,00	10	89	47	35	40	SCD661-0900-3-3-145HA03-HP358	30902089
9,10	10	89	47	35	40	SCD661-0910-3-3-145HA03-HP358	30902090
9,20	10	89	47	35	40	SCD661-0920-3-3-145HA03-HP358	30902091
9,30	10	89	47	35	40	SCD661-0930-3-3-145HA03-HP358	30902092
9,35	10	89	47	35	40	SCD661-0935-3-3-145HA03-HP358	31307523
9,40	10	89	47	35	40	SCD661-0940-3-3-145HA03-HP358	30902093
9,50	10	89	47	35	40	SCD661-0950-3-3-145HA03-HP358	30902094
9,60	10	89	47	35	40	SCD661-0960-3-3-145HA03-HP358	30902095
9,70	10	89	47	35	40	SCD661-0970-3-3-145HA03-HP358	30902096
9,80	10	89	47	35	40	SCD661-0980-3-3-145HA03-HP358	30902097
9,90	10	89	47	35	40	SCD661-0990-3-3-145HA03-HP358	30902098
10,00	10	89	47	35	40	SCD661-1000-3-3-145HA03-HP358	30902099
10,10	12	102	55	40	45	SCD661-1010-3-3-145HA03-HP358	30902100
10,20	12	102	55	40	45	SCD661-1020-3-3-145HA03-HP358	30902101
10,30	12	102	55	40	45	SCD661-1030-3-3-145HA03-HP358	30902102
10,40	12	102	55	40	45	SCD661-1040-3-3-145HA03-HP358	30902103
10,50	12	102	55	40	45	SCD661-1050-3-3-145HA03-HP358	30902104
10,80	12	102	55	40	45	SCD661-1080-3-3-145HA03-HP358	30902107
10,90	12	102	55	40	45	SCD661-1090-3-3-145HA03-HP358	30902108
11,00	12	102	55	40	45	SCD661-1100-3-3-145HA03-HP358	30902109
11,10	12	102	55	40	45	SCD661-1110-3-3-145HA03-HP358	30902110
11,20	12	102	55	40	45	SCD661-1120-3-3-145HA03-HP358	30902111
11,30	12	102	55	40	45	SCD661-1130-3-3-145HA03-HP358	30902112
11,40	12	102	55	40	45	SCD661-1140-3-3-145HA03-HP358	30902113
11,50	12	102	55	40	45	SCD661-1150-3-3-145HA03-HP358	30902114
11,60	12	102	55	40	45	SCD661-1160-3-3-145HA03-HP358	30902115
11,70	12	102	55	40	45	SCD661-1170-3-3-145HA03-HP358	30902116
11,80	12	102	55	40	45	SCD661-1180-3-3-145HA03-HP358	30902117
11,90	12	102	55	40	45	SCD661-1190-3-3-145HA03-HP358	30902118
12,00	12	102	55	40	45	SCD661-1200-3-3-145HA03-HP358	30902119
12,20	14	107	60	43	45	SCD661-1220-3-3-145HA03-HP358	30902120
12,23	14	107	60	43	45	SCD661-1223-3-3-145HA03-HP358	31271441
12,50	14	107	60	43	45	SCD661-1250-3-3-145HA03-HP358	30902121
12,70	14	107	60	43	45	SCD661-1270-3-3-145HA03-HP358	31307524
13,00	14	107	60	43	45	SCD661-1300-3-3-145HA03-HP358	30902123
13,50	14	107	60	43	45	SCD661-1350-3-3-145HA03-HP358	30902125
13,80	14	107	60	43	45	SCD661-1380-3-3-145HA03-HP358	30902126
14,00	14	107	60	43	45	SCD661-1400-3-3-145HA03-HP358	30902127
14,20	16	115	65	45	48	SCD661-1420-3-3-145HA03-HP358	30902128

Tritan-Drill-Steel | Wiertło spiralne z węgla spiekane SCD661 (3xD), wewnętrzne doprowadzenie chłodziwa

Wymiary						Typ chwytu HA	
d ₁ h7	d ₂ h6	l ₁	l ₂	l ₃	l ₄	Specyfikacja	Nr materiałowy
14,50	16	115	65	45	48	SCD661-1450-3-3-145HA03-HP358	30902129
14,80	16	115	65	45	48	SCD661-1480-3-3-145HA03-HP358	30902130
15,00	16	115	65	45	48	SCD661-1500-3-3-145HA03-HP358	30902131
15,20	16	115	65	45	48	SCD661-1520-3-3-145HA03-HP358	30902132
15,50	16	115	65	45	48	SCD661-1550-3-3-145HA03-HP358	30902133
15,80	16	115	65	45	48	SCD661-1580-3-3-145HA03-HP358	30902134
16,00	16	115	65	45	48	SCD661-1600-3-3-145HA03-HP358	30902135
16,20	18	123	73	51	48	SCD661-1620-3-3-145HA03-HP358	30902136
16,50	18	123	73	51	48	SCD661-1650-3-3-145HA03-HP358	30902137
17,00	18	123	73	51	48	SCD661-1700-3-3-145HA03-HP358	30902139
17,35	18	123	73	51	48	SCD661-1735-3-3-145HA03-HP358	31307525
17,50	18	123	73	51	48	SCD661-1750-3-3-145HA03-HP358	30902141
17,80	18	123	73	51	48	SCD661-1780-3-3-145HA03-HP358	30902142
18,00	18	123	73	51	48	SCD661-1800-3-3-145HA03-HP358	30902143
18,50	20	131	79	55	50	SCD661-1850-3-3-145HA03-HP358	30902145
18,80	20	131	79	55	50	SCD661-1880-3-3-145HA03-HP358	30902146
19,00	20	131	79	55	50	SCD661-1900-3-3-145HA03-HP358	30902147
19,50	20	131	79	55	50	SCD661-1950-3-3-145HA03-HP358	30902149
20,00	20	131	79	55	50	SCD661-2000-3-3-145HA03-HP358	30902151

Możliwość konfiguracji parametrów



Średnica:
możliwość wyboru średnicy w krokach co 0,01 mm





Typ chwytu:
Typ chwytu: HB | HE

Specyfikacja:
SCD661-[średnica]-3-3-140[typ chwytu]03-HP358

Wymiary typoszeregu z możliwością konfiguracji parametrów

d ₁ min.	d ₁ max.	d ₂ h6	l ₁	l ₂	l ₃	l ₄
4,00	4,70	6	66	24	17	36
4,71	6,00	6	66	28	20	36
6,01	7,00	8	79	34	24	36
7,01	8,00	8	79	41	29	36
8,01	10,00	10	89	47	35	40
10,01	12,00	12	102	55	40	45
12,01	14,00	14	107	60	43	45
14,01	16,00	16	115	65	45	48
16,01	18,00	18	123	73	51	48
18,01	20,00	20	131	79	55	50

Przykład:

SCD661-0431-3-3-140HE03-HP358

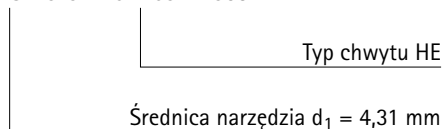

Wymiary podano w mm.

Zalecane parametry skrawania - patrz koniec rozdziału.

Wersje specjalne i inne powłoki wg zapytania ofertowego.

Tritan-Drill-Steel

Wiertła spiralne z węgla spiekane
SCD661 (5xD), wewnętrzne doprowadzenie chłodziwa

Wersja:

Średnica wiertła: 4,00 – 20,00 mm
Tolerancja otworu: \geq IT 9
Materiał skrawający: HP358
Liczba ostrzy: 3
Liczba łysinek: 3
Kąt wierchołkowy: 145°
Kąt spirali: 30°

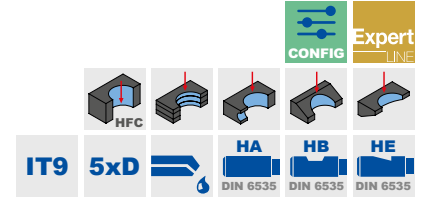
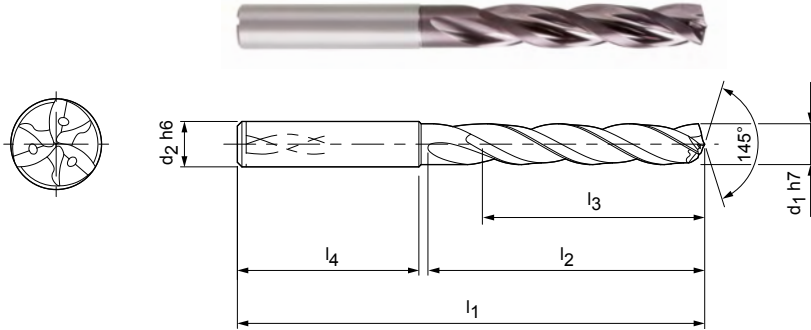

Magazynowa seria preferowana z typem chwytu HA

Wymiary						Typ chwytu HA	
d_1 h7	d_2 h6	l_1	l_2	l_3	l_4	Specyfikacja	Nr materiałowy
4,00	6	74	36	29	36	SCD661-0400-3-3-145HA05-HP358	30902152
4,10	6	74	36	29	36	SCD661-0410-3-3-145HA05-HP358	30902153
4,20	6	74	36	29	36	SCD661-0420-3-3-145HA05-HP358	30902154
4,30	6	74	36	29	36	SCD661-0430-3-3-145HA05-HP358	30902155
4,40	6	74	36	29	36	SCD661-0440-3-3-145HA05-HP358	30902156
4,50	6	74	36	29	36	SCD661-0450-3-3-145HA05-HP358	30902157
4,60	6	74	36	29	36	SCD661-0460-3-3-145HA05-HP358	30902158
4,65	6	74	36	29	36	SCD661-0465-3-3-145HA05-HP358	30902159
4,70	6	74	36	29	36	SCD661-0470-3-3-145HA05-HP358	30902160
4,80	6	82	44	35	36	SCD661-0480-3-3-145HA05-HP358	30902161
4,90	6	82	44	35	36	SCD661-0490-3-3-145HA05-HP358	30902162
5,00	6	82	44	35	36	SCD661-0500-3-3-145HA05-HP358	30902163
5,10	6	82	44	35	36	SCD661-0510-3-3-145HA05-HP358	30902164
5,20	6	82	44	35	36	SCD661-0520-3-3-145HA05-HP358	30902165
5,30	6	82	44	35	36	SCD661-0530-3-3-145HA05-HP358	30902166
5,40	6	82	44	35	36	SCD661-0540-3-3-145HA05-HP358	30902167
5,50	6	82	44	35	36	SCD661-0550-3-3-145HA05-HP358	30902168
5,55	6	82	44	35	36	SCD661-0555-3-3-145HA05-HP358	30902169
5,60	6	82	44	35	36	SCD661-0560-3-3-145HA05-HP358	30902170
5,70	6	82	44	35	36	SCD661-0570-3-3-145HA05-HP358	30902171
5,80	6	82	44	35	36	SCD661-0580-3-3-145HA05-HP358	30902172
5,90	6	82	44	35	36	SCD661-0590-3-3-145HA05-HP358	30902173
6,00	6	82	44	35	36	SCD661-0600-3-3-145HA05-HP358	30902174
6,05	8	91	53	43	36	SCD661-0605-3-3-145HA05-HP358	31307526
6,10	8	91	53	43	36	SCD661-0610-3-3-145HA05-HP358	30902175
6,20	8	91	53	43	36	SCD661-0620-3-3-145HA05-HP358	30902176
6,30	8	91	53	43	36	SCD661-0630-3-3-145HA05-HP358	30902177
6,40	8	91	53	43	36	SCD661-0640-3-3-145HA05-HP358	30902178
6,50	8	91	53	43	36	SCD661-0650-3-3-145HA05-HP358	30902179
6,60	8	91	53	43	36	SCD661-0660-3-3-145HA05-HP358	30902180
6,80	8	91	53	43	36	SCD661-0680-3-3-145HA05-HP358	30902182
6,90	8	91	53	43	36	SCD661-0690-3-3-145HA05-HP358	30902183
7,00	8	91	53	43	36	SCD661-0700-3-3-145HA05-HP358	30902184
7,10	8	91	53	43	36	SCD661-0710-3-3-145HA05-HP358	30902185
7,20	8	91	53	43	36	SCD661-0720-3-3-145HA05-HP358	30902186

Tritan-Drill-Steel | Wiertło spiralne z węgla spiekane SCD661 (5xD), wewnętrzne doprowadzenie chłodziwa

Wymiary						Typ chwytu HA	
d ₁ h7	d ₂ h6	l ₁	l ₂	l ₃	l ₄	Specyfikacja	Nr materiałowy
7,30	8	91	53	43	36	SCD661-0730-3-3-145HA05-HP358	30902187
7,40	8	91	53	43	36	SCD661-0740-3-3-145HA05-HP358	30902188
7,45	8	91	53	43	36	SCD661-0745-3-3-145HA05-HP358	30902189
7,50	8	91	53	43	36	SCD661-0750-3-3-145HA05-HP358	30902190
7,60	8	91	53	43	36	SCD661-0760-3-3-145HA05-HP358	30902191
7,70	8	91	53	43	36	SCD661-0770-3-3-145HA05-HP358	30902192
7,80	8	91	53	43	36	SCD661-0780-3-3-145HA05-HP358	30902193
7,90	8	91	53	43	36	SCD661-0790-3-3-145HA05-HP358	30902194
8,00	8	91	53	43	36	SCD661-0800-3-3-145HA05-HP358	30902195
8,10	10	103	61	49	40	SCD661-0810-3-3-145HA05-HP358	30902196
8,20	10	103	61	49	40	SCD661-0820-3-3-145HA05-HP358	30902197
8,30	10	103	61	49	40	SCD661-0830-3-3-145HA05-HP358	30902198
8,40	10	103	61	49	40	SCD661-0840-3-3-145HA05-HP358	30902199
8,50	10	103	61	49	40	SCD661-0850-3-3-145HA05-HP358	30902200
8,60	10	103	61	49	40	SCD661-0860-3-3-145HA05-HP358	30902201
8,70	10	103	61	49	40	SCD661-0870-3-3-145HA05-HP358	30902202
8,80	10	103	61	49	40	SCD661-0880-3-3-145HA05-HP358	30902203
8,90	10	103	61	49	40	SCD661-0890-3-3-145HA05-HP358	30902204
9,00	10	103	61	49	40	SCD661-0900-3-3-145HA05-HP358	30902205
9,10	10	103	61	49	40	SCD661-0910-3-3-145HA05-HP358	30902206
9,20	10	103	61	49	40	SCD661-0920-3-3-145HA05-HP358	30902207
9,30	10	103	61	49	40	SCD661-0930-3-3-145HA05-HP358	30902208
9,35	10	103	61	49	40	SCD661-0935-3-3-145HA05-HP358	30902209
9,40	10	103	61	49	40	SCD661-0940-3-3-145HA05-HP358	30902210
9,50	10	103	61	49	40	SCD661-0950-3-3-145HA05-HP358	30902211
9,70	10	103	61	49	40	SCD661-0970-3-3-145HA05-HP358	30902214
9,80	10	103	61	49	40	SCD661-0980-3-3-145HA05-HP358	30902215
9,90	10	103	61	49	40	SCD661-0990-3-3-145HA05-HP358	30902216
10,00	10	103	61	49	40	SCD661-1000-3-3-145HA05-HP358	30902217
10,10	12	118	71	56	45	SCD661-1010-3-3-145HA05-HP358	30902218
10,20	12	118	71	56	45	SCD661-1020-3-3-145HA05-HP358	30902219
10,30	12	118	71	56	45	SCD661-1030-3-3-145HA05-HP358	30902220
10,40	12	118	71	56	45	SCD661-1040-3-3-145HA05-HP358	30902221
10,50	12	118	71	56	45	SCD661-1050-3-3-145HA05-HP358	30902222
10,80	12	118	71	56	45	SCD661-1080-3-3-145HA05-HP358	30902225
11,00	12	118	71	56	45	SCD661-1100-3-3-145HA05-HP358	30902227
11,10	12	118	71	56	45	SCD661-1110-3-3-145HA05-HP358	30902228
11,20	12	118	71	56	45	SCD661-1120-3-3-145HA05-HP358	30902229
11,30	12	118	71	56	45	SCD661-1130-3-3-145HA05-HP358	30902230
11,40	12	118	71	56	45	SCD661-1140-3-3-145HA05-HP358	30902231
11,50	12	118	71	56	45	SCD661-1150-3-3-145HA05-HP358	30902232
11,80	12	118	71	56	45	SCD661-1180-3-3-145HA05-HP358	30902235
11,90	12	118	71	56	45	SCD661-1190-3-3-145HA05-HP358	30902236
12,00	12	118	71	56	45	SCD661-1200-3-3-145HA05-HP358	30902237
12,20	14	124	77	60	45	SCD661-1220-3-3-145HA05-HP358	30902238
12,50	14	124	77	60	45	SCD661-1250-3-3-145HA05-HP358	30902239
12,80	14	124	77	60	45	SCD661-1280-3-3-145HA05-HP358	30902240
13,00	14	124	77	60	45	SCD661-1300-3-3-145HA05-HP358	30902241
13,50	14	124	77	60	45	SCD661-1350-3-3-145HA05-HP358	30902243
13,80	14	124	77	60	45	SCD661-1380-3-3-145HA05-HP358	30902244
14,00	14	124	77	60	45	SCD661-1400-3-3-145HA05-HP358	30902245
14,20	16	133	83	63	48	SCD661-1420-3-3-145HA05-HP358	30902246
14,50	16	133	83	63	48	SCD661-1450-3-3-145HA05-HP358	30902247
14,80	16	133	83	63	48	SCD661-1480-3-3-145HA05-HP358	30902248
15,00	16	133	83	63	48	SCD661-1500-3-3-145HA05-HP358	30902249
15,10	16	133	83	63	48	SCD661-1510-3-3-145HA05-HP358	30902250
15,20	16	133	83	63	48	SCD661-1520-3-3-145HA05-HP358	30902251

Ciąg dalszy na następnej stronie.

Tritan-Drill-Steel | Wiertło spiralne z węgla spiekane SCD661 (5xD), wewnętrzne doprowadzenie chłodziwa

Wymiary						Typ chwytu HA	
d ₁ h7	d ₂ h6	l ₁	l ₂	l ₃	l ₄	Specyfikacja	Nr materiałowy
15,25	16	133	83	63	48	SCD661-1525-3-3-145HA05-HP358	30902252
15,50	16	133	83	63	48	SCD661-1550-3-3-145HA05-HP358	30902253
15,80	16	133	83	63	48	SCD661-1580-3-3-145HA05-HP358	30902254
16,00	16	133	83	63	48	SCD661-1600-3-3-145HA05-HP358	30902255
16,20	18	143	93	71	48	SCD661-1620-3-3-145HA05-HP358	30902256
16,50	18	143	93	71	48	SCD661-1650-3-3-145HA05-HP358	30902257
16,80	18	143	93	71	48	SCD661-1680-3-3-145HA05-HP358	30902258
17,00	18	143	93	71	48	SCD661-1700-3-3-145HA05-HP358	30902259
17,50	18	143	93	71	48	SCD661-1750-3-3-145HA05-HP358	30902261
18,00	18	143	93	71	48	SCD661-1800-3-3-145HA05-HP358	30902263
18,50	20	153	101	77	50	SCD661-1850-3-3-145HA05-HP358	30902265
18,80	20	153	101	77	50	SCD661-1880-3-3-145HA05-HP358	30902266
19,00	20	153	101	77	50	SCD661-1900-3-3-145HA05-HP358	30902267
19,50	20	153	101	77	50	SCD661-1950-3-3-145HA05-HP358	30902269
19,80	20	153	101	77	50	SCD661-1980-3-3-145HA05-HP358	30902270
20,00	20	153	101	77	50	SCD661-2000-3-3-145HA05-HP358	30902271

Możliwość konfiguracji parametrów



Średnica:
możliwość wyboru średnicy w
krokach co 0,01 mm





Typ chwytu:
Typ chwytu: HB | HE

Specyfikacja:
SCD661-[średnica]-3-3-145[typ chwytu]05-HP358

Wymiary typoszeregu z możliwością konfiguracji parametrów

d ₁ min.	d ₁ max.	d ₂ h6	l ₁	l ₂	l ₃	l ₄
4,00	4,70	6	74	36	29	36
4,71	6,00	6	82	44	35	36
6,01	8,00	8	91	53	43	36
8,01	10,00	10	103	61	49	40
10,01	12,00	12	118	71	56	45
12,01	14,00	14	124	77	60	45
14,01	16,00	16	133	83	63	48
16,01	18,00	18	143	93	71	48
18,01	20,00	20	153	101	77	50

Przykład:

SCD661-0431-3-3-145HE05-HP358

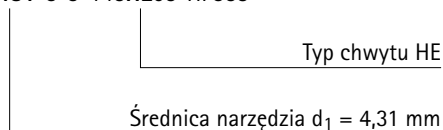

Wymiary podano w mm.

Zalecane parametry skrawania - patrz koniec rozdziału.

Wersje specjalne i inne powłoki wg zapytania ofertowego.

Tritan-Drill-Steel

Wiertła spiralne z węgla spiekane
SCD661 (8xD), wewnętrzne doprowadzenie chłodziwa

Wersja:

Średnica wiertła: 4,00 – 20,00 mm
Tolerancja otworu: \geq IT 9
Materiał skrawający: HP358
Liczba ostrzy: 3
Liczba łysinek: 3
Kąt wierchołkowy: 140°
Kąt spirali: 30°

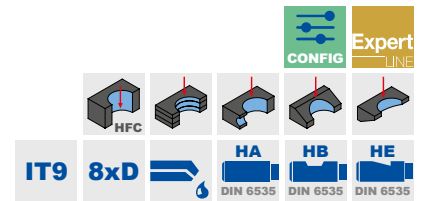
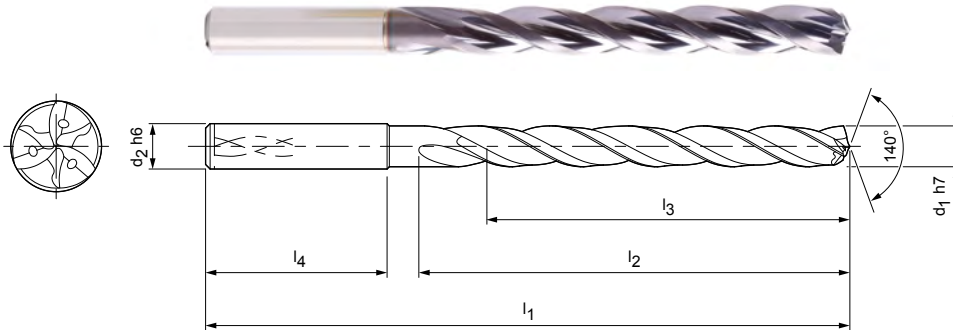

Magazynowa seria preferowana z typem chwytu HA

Wymiary						Typ chwytu HA	
d ₁ h7	d ₂ h6	l ₁	l ₂	l ₃	l ₄	Specyfikacja	Nr materiałowy
4,00	6	81	43	36	36	SCD661-0400-3-3-140HA08-HP358	30902272
4,10	6	81	43	36	36	SCD661-0410-3-3-140HA08-HP358	30902273
4,20	6	81	43	36	36	SCD661-0420-3-3-140HA08-HP358	30902274
4,30	6	81	43	36	36	SCD661-0430-3-3-140HA08-HP358	30902275
4,50	6	81	43	36	36	SCD661-0450-3-3-140HA08-HP358	30902277
4,60	6	81	43	36	36	SCD661-0460-3-3-140HA08-HP358	30902278
4,70	6	81	43	36	36	SCD661-0470-3-3-140HA08-HP358	30902279
4,80	6	95	57	48	36	SCD661-0480-3-3-140HA08-HP358	30902280
5,00	6	95	57	48	36	SCD661-0500-3-3-140HA08-HP358	30902282
5,10	6	95	57	48	36	SCD661-0510-3-3-140HA08-HP358	30902283
5,20	6	95	57	48	36	SCD661-0520-3-3-140HA08-HP358	30902284
5,40	6	95	57	48	36	SCD661-0540-3-3-140HA08-HP358	30902286
5,50	6	95	57	48	36	SCD661-0550-3-3-140HA08-HP358	30902287
5,60	6	95	57	48	36	SCD661-0560-3-3-140HA08-HP358	30902288
5,80	6	95	57	48	36	SCD661-0580-3-3-140HA08-HP358	30902290
5,90	6	95	57	48	36	SCD661-0590-3-3-140HA08-HP358	30902291
6,00	6	95	57	48	36	SCD661-0600-3-3-140HA08-HP358	30902292
6,10	8	114	76	64	36	SCD661-0610-3-3-140HA08-HP358	30902293
6,50	8	114	76	64	36	SCD661-0650-3-3-140HA08-HP358	30902297
6,60	8	114	76	64	36	SCD661-0660-3-3-140HA08-HP358	30902298
6,80	8	114	76	64	36	SCD661-0680-3-3-140HA08-HP358	30902300
6,90	8	114	76	64	36	SCD661-0690-3-3-140HA08-HP358	30902301
7,00	8	114	76	64	36	SCD661-0700-3-3-140HA08-HP358	30902302
7,50	8	114	76	64	36	SCD661-0750-3-3-140HA08-HP358	30902307
7,80	8	114	76	64	36	SCD661-0780-3-3-140HA08-HP358	30902310
7,90	8	114	76	64	36	SCD661-0790-3-3-140HA08-HP358	30902311
8,00	8	114	76	64	36	SCD661-0800-3-3-140HA08-HP358	30902312
8,10	10	142	95	80	40	SCD661-0810-3-3-140HA08-HP358	30902313
8,20	10	142	95	80	40	SCD661-0820-3-3-140HA08-HP358	30902314
8,50	10	142	95	80	40	SCD661-0850-3-3-140HA08-HP358	30902317
8,60	10	142	95	80	40	SCD661-0860-3-3-140HA08-HP358	30902318
8,80	10	142	95	80	40	SCD661-0880-3-3-140HA08-HP358	30902320
9,00	10	142	95	80	40	SCD661-0900-3-3-140HA08-HP358	30902322
9,10	10	142	95	80	40	SCD661-0910-3-3-140HA08-HP358	30902323
9,50	10	142	95	80	40	SCD661-0950-3-3-140HA08-HP358	30902327

Tritan-Drill-Steel-Plus | Wiertło kręte z węgla spiekane SCD661 (8xD), wewnętrzne doprowadzenie chłodziwa

Wymiary						Typ chwytu HA	
d ₁ h7	d ₂ h6	l ₁	l ₂	l ₃	l ₄	Specyfikacja	Nr materiałowy
9,80	10	142	95	80	40	SCD661-0980-3-3-140HA08-HP358	30902330
10,00	10	142	95	80	40	SCD661-1000-3-3-140HA08-HP358	30902332
10,20	12	162	114	96	45	SCD661-1020-3-3-140HA08-HP358	30902334
10,30	12	162	114	96	45	SCD661-1030-3-3-140HA08-HP358	30902335
10,50	12	162	114	96	45	SCD661-1050-3-3-140HA08-HP358	30902337
11,00	12	162	114	96	45	SCD661-1100-3-3-140HA08-HP358	30902342
11,50	12	162	114	96	45	SCD661-1150-3-3-140HA08-HP358	30902347
11,80	12	162	114	96	45	SCD661-1180-3-3-140HA08-HP358	30902350
11,90	12	162	114	96	45	SCD661-1190-3-3-140HA08-HP358	30902351
12,00	12	162	114	96	45	SCD661-1200-3-3-140HA08-HP358	30902352
12,20	14	178	133	112	45	SCD661-1220-3-3-140HA08-HP358	30902353
12,50	14	178	133	112	45	SCD661-1250-3-3-140HA08-HP358	30902354
13,00	14	178	133	112	45	SCD661-1300-3-3-140HA08-HP358	30902356
13,50	14	178	133	112	45	SCD661-1350-3-3-140HA08-HP358	30902358
13,80	14	178	133	112	45	SCD661-1380-3-3-140HA08-HP358	30902359
14,00	14	178	133	112	45	SCD661-1400-3-3-140HA08-HP358	30902360
14,20	16	203	152	128	48	SCD661-1420-3-3-140HA08-HP358	30902361
14,50	16	203	152	128	48	SCD661-1450-3-3-140HA08-HP358	30902362
15,00	16	203	152	128	48	SCD661-1500-3-3-140HA08-HP358	30902364
15,50	16	203	152	128	48	SCD661-1550-3-3-140HA08-HP358	30902366
15,80	16	203	152	128	48	SCD661-1580-3-3-140HA08-HP358	30902367
16,00	16	203	152	128	48	SCD661-1600-3-3-140HA08-HP358	30902368
17,00	18	222	171	144	48	SCD661-1700-3-3-140HA08-HP358	30902372
17,50	18	222	171	144	48	SCD661-1750-3-3-140HA08-HP358	30902374
18,00	18	222	171	144	48	SCD661-1800-3-3-140HA08-HP358	30902376
18,50	20	243	190	160	50	SCD661-1850-3-3-140HA08-HP358	30902378
19,00	20	243	190	160	50	SCD661-1900-3-3-140HA08-HP358	30902380
19,20	20	243	190	160	50	SCD661-1920-3-3-140HA08-HP358	30902381
19,50	20	243	190	160	50	SCD661-1950-3-3-140HA08-HP358	30902382
20,00	20	243	190	160	50	SCD661-2000-3-3-140HA08-HP358	30902384

Możliwość konfiguracji parametrów



Średnica:
możliwość wyboru średnicy w
krokach co 0,01 mm





Typ chwytu:
Typ chwytu: HB | HE

Specyfikacja:
SCD661-[średnica]-3-3-140[typ chwytu]08-HP358

Wymiary typoszeregu z możliwością konfiguracji parametrów

d ₁ min.	d ₁ max.	d ₂ h6	l ₁	l ₂	l ₃	l ₄
4,00	4,70	6	81	43	36	36
4,71	6,00	6	95	57	48	36
6,01	8,00	8	114	76	64	36
8,01	10,00	10	142	95	80	40
10,01	12,00	12	162	114	96	45
12,01	14,00	14	178	133	112	45
14,01	16,00	16	203	152	128	48
16,01	18,00	18	222	171	144	48
18,01	20,00	20	243	190	160	50

Przykład:

SCD661-0431-3-3-140HE08-HP358

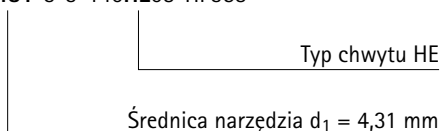

Wymiary podano w mm.

Zalecane parametry skrawania - patrz koniec rozdziału.

Wersje specjalne i inne powłoki wg zapytania ofertowego.

Tritan-Drill-Steel

Wiertła spiralne z węgla spiekane
SCD661 (12xD), wewnętrzne doprowadzenie chłodziwa

Wersja:

Średnica wiertła: 4,00 – 20,00 mm
Tolerancja otworu: ≥ IT 9
Materiał skrawający: HP358
Liczba ostrzy: 3
Liczba łysinek: 3
Kąt wierchołkowy: 140°
Kąt spirali: 30°

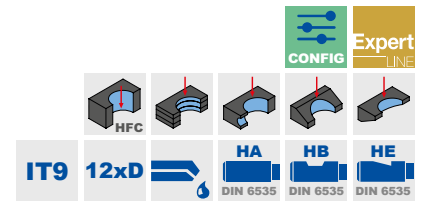
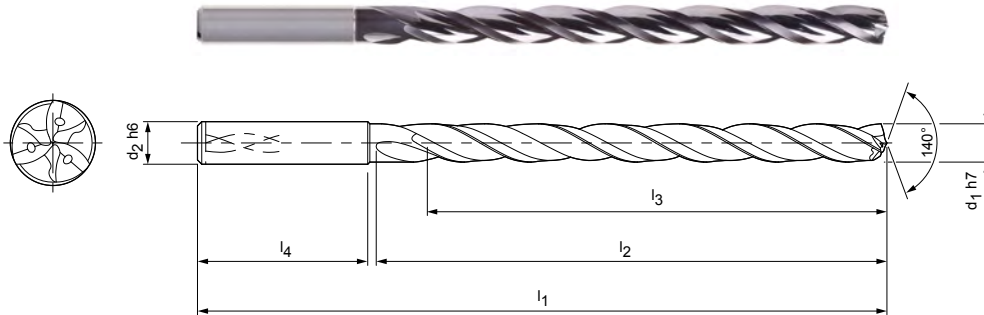

Magazynowa seria preferowana z typem chwytu HA

Wymiary						Typ chwytu HA	
d ₁ h7	d ₂ h6	l ₁	l ₂	l ₃	l ₄	Specyfikacja	Nr materiałowy
4,00	6	102	64	58	36	SCD661-0400-3-3-140HA12-HP358	30902385
4,10	6	102	64	58	36	SCD661-0410-3-3-140HA12-HP358	30902386
4,20	6	102	64	58	36	SCD661-0420-3-3-140HA12-HP358	30902387
4,30	6	102	64	58	36	SCD661-0430-3-3-140HA12-HP358	30902388
4,50	6	102	64	58	36	SCD661-0450-3-3-140HA12-HP358	30902390
4,60	6	102	64	58	36	SCD661-0460-3-3-140HA12-HP358	30902391
4,80	6	116	78	70	36	SCD661-0480-3-3-140HA12-HP358	30902393
5,00	6	116	78	70	36	SCD661-0500-3-3-140HA12-HP358	30902395
5,10	6	116	78	70	36	SCD661-0510-3-3-140HA12-HP358	30902396
5,20	6	116	78	70	36	SCD661-0520-3-3-140HA12-HP358	30902397
5,40	6	116	78	70	36	SCD661-0540-3-3-140HA12-HP358	30902399
5,50	6	116	78	70	36	SCD661-0550-3-3-140HA12-HP358	30902400
5,80	6	116	78	70	36	SCD661-0580-3-3-140HA12-HP358	30902403
5,90	6	116	78	70	36	SCD661-0590-3-3-140HA12-HP358	30902404
6,00	6	116	78	70	36	SCD661-0600-3-3-140HA12-HP358	30902405
6,10	8	146	108	94	36	SCD661-0610-3-3-140HA12-HP358	30902406
6,50	8	146	108	94	36	SCD661-0650-3-3-140HA12-HP358	30902410
6,80	8	146	108	94	36	SCD661-0680-3-3-140HA12-HP358	30902413
7,00	8	146	108	94	36	SCD661-0700-3-3-140HA12-HP358	30902415
7,50	8	146	108	94	36	SCD661-0750-3-3-140HA12-HP358	30902420
7,80	8	146	108	94	36	SCD661-0780-3-3-140HA12-HP358	30902423
7,90	8	146	108	94	36	SCD661-0790-3-3-140HA12-HP358	30902424
8,00	8	146	108	94	36	SCD661-0800-3-3-140HA12-HP358	30902425
8,20	10	162	120	110	40	SCD661-0820-3-3-140HA12-HP358	30902427
8,40	10	162	120	110	40	SCD661-0840-3-3-140HA12-HP358	30902429
8,50	10	162	120	110	40	SCD661-0850-3-3-140HA12-HP358	30902430
8,80	10	162	120	110	40	SCD661-0880-3-3-140HA12-HP358	30902433
9,00	10	162	120	110	40	SCD661-0900-3-3-140HA12-HP358	30902435
9,50	10	162	120	110	40	SCD661-0950-3-3-140HA12-HP358	30902440
9,60	10	162	120	110	40	SCD661-0960-3-3-140HA12-HP358	30902441
9,80	10	162	120	110	40	SCD661-0980-3-3-140HA12-HP358	30902443
10,00	10	162	120	110	40	SCD661-1000-3-3-140HA12-HP358	30902445
10,20	12	204	156	142	45	SCD661-1020-3-3-140HA12-HP358	30902447
10,30	12	204	156	142	45	SCD661-1030-3-3-140HA12-HP358	30902448
10,50	12	204	156	142	45	SCD661-1050-3-3-140HA12-HP358	30902450

Tritan-Drill-Steel | Wiertło spiralne z węgla spiekane SCD661 (12xD), wewnętrzne doprowadzenie chłodziwa

Wymiary						Typ chwytu HA	
d ₁ h7	d ₂ h6	l ₁	l ₂	l ₃	l ₄	Specyfikacja	Nr materiałowy
11,00	12	204	156	142	45	SCD661-1100-3-3-140HA12-HP358	30902455
11,50	12	204	156	142	45	SCD661-1150-3-3-140HA12-HP358	30902460
11,80	12	204	156	142	45	SCD661-1180-3-3-140HA12-HP358	30902463
12,00	12	204	156	142	45	SCD661-1200-3-3-140HA12-HP358	30902465
12,50	14	230	182	166	45	SCD661-1250-3-3-140HA12-HP358	30902467
13,00	14	230	182	166	45	SCD661-1300-3-3-140HA12-HP358	30902469
13,50	14	230	182	166	45	SCD661-1350-3-3-140HA12-HP358	30902471
14,00	14	230	182	166	45	SCD661-1400-3-3-140HA12-HP358	30902473
14,50	16	260	208	192	48	SCD661-1450-3-3-140HA12-HP358	30902475
15,00	16	260	208	192	48	SCD661-1500-3-3-140HA12-HP358	30902477
15,50	16	260	208	192	48	SCD661-1550-3-3-140HA12-HP358	30902479
16,00	16	260	208	192	48	SCD661-1600-3-3-140HA12-HP358	30902481
16,50	18	285	234	216	48	SCD661-1650-3-3-140HA12-HP358	30902483
17,00	18	285	234	216	48	SCD661-1700-3-3-140HA12-HP358	30902485
17,50	18	285	234	216	48	SCD661-1750-3-3-140HA12-HP358	30902487
18,00	18	285	234	216	48	SCD661-1800-3-3-140HA12-HP358	30902489
18,50	20	310	258	240	50	SCD661-1850-3-3-140HA12-HP358	30902491
19,00	20	310	258	240	50	SCD661-1900-3-3-140HA12-HP358	30902493
19,50	20	310	258	240	50	SCD661-1950-3-3-140HA12-HP358	30902495
20,00	20	310	258	240	50	SCD661-2000-3-3-140HA12-HP358	30902497

Możliwość konfiguracji parametrów



Średnica:
możliwość wyboru średnicy w krokach co 0,01 mm





Typ chwytu:
Typ chwytu: HB | HE

Specyfikacja:
SCD661-[średnica]-3-3-140[typ chwytu]12-HP358

Wymiary typoszeregu z możliwością konfiguracji parametrów

d ₁ min.	d ₁ max.	d ₂ h6	l ₁	l ₂	l ₃	l ₄
4,00	4,70	6	102	64	58	36
4,71	6,00	6	116	78	70	36
6,01	8,00	8	146	108	94	36
8,01	10,00	10	162	120	110	40
10,01	12,00	12	204	156	142	45
12,01	14,00	14	230	182	166	45
14,01	16,00	16	260	208	192	48
16,01	18,00	18	285	234	216	48
18,01	20,00	20	310	258	240	50

Przykład:

SCD661-0431-3-3-140HE12-HP358

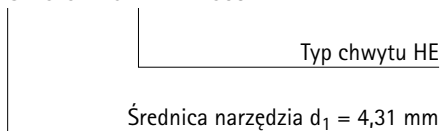

Wymiary podano w mm.

Zalecane parametry skrawania - patrz koniec rozdziału.

Wersje specjalne i inne powłoki wg zapytania ofertowego.

MEGA-Speed-Drill-Steel

Wiertła spiralne z węgla spiekanego

SCD621 (3xD), wewnętrzne doprowadzenie chłodziwa, następcą MEGA-Speed-Drill-Uni (SCD22)

Wersja:

- Średnica wiertła: 3,00 – 20,00 mm
- Tolerancja otworu: IT 9 (osiągalne)
- Materiał skrawający: HP358
- Liczba ostrzy: 2
- Liczba łysinek: 3
- Kąt wierzchołkowy: 145°
- Kąt spirali: 30°

Zastosowanie:

Do obróbki z dużymi prędkościami.

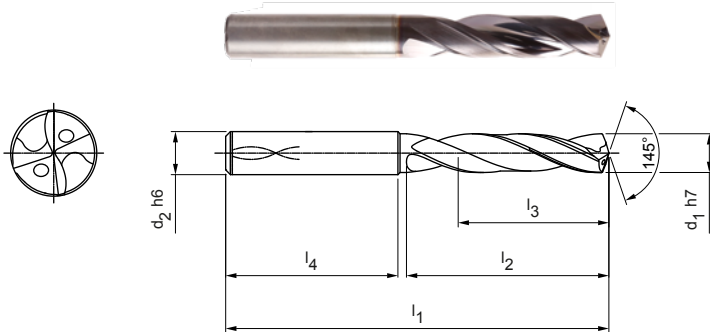

Magazynowa seria preferowana z typem chwytu HA

Wymiary						Typ chwytu HA	
d ₁ h7	d ₂ h6	l ₁	l ₂	l ₃	l ₄	Specyfikacja	Nr materiałowy
3,00	6	62	20	14	36	SCD621-0300-2-3-145HA03-HP358	31036265
3,20	6	62	20	14	36	SCD621-0320-2-3-145HA03-HP358	31036267
3,30	6	62	20	14	36	SCD621-0330-2-3-145HA03-HP358	31036268
3,40	6	62	20	14	36	SCD621-0340-2-3-145HA03-HP358	31036269
3,50	6	62	20	14	36	SCD621-0350-2-3-145HA03-HP358	31036270
3,70	6	62	20	14	36	SCD621-0370-2-3-145HA03-HP358	31036272
3,80	6	66	24	17	36	SCD621-0380-2-3-145HA03-HP358	31036273
3,90	6	66	24	17	36	SCD621-0390-2-3-145HA03-HP358	31036274
4,00	6	66	24	17	36	SCD621-0400-2-3-145HA03-HP358	31036275
4,10	6	66	24	17	36	SCD621-0410-2-3-145HA03-HP358	31036276
4,20	6	66	24	17	36	SCD621-0420-2-3-145HA03-HP358	31036277
4,30	6	66	24	17	36	SCD621-0430-2-3-145HA03-HP358	31036278
4,50	6	66	24	17	36	SCD621-0450-2-3-145HA03-HP358	31036280
4,60	6	66	24	17	36	SCD621-0460-2-3-145HA03-HP358	31036281
4,65	6	66	24	17	36	SCD621-0465-2-3-145HA03-HP358	31307528
4,70	6	66	24	17	36	SCD621-0470-2-3-145HA03-HP358	31036282
4,90	6	66	28	20	36	SCD621-0490-2-3-145HA03-HP358	31036284
5,00	6	66	28	20	36	SCD621-0500-2-3-145HA03-HP358	31036285
5,10	6	66	28	20	36	SCD621-0510-2-3-145HA03-HP358	31036286
5,20	6	66	28	20	36	SCD621-0520-2-3-145HA03-HP358	31036287
5,50	6	66	28	20	36	SCD621-0550-2-3-145HA03-HP358	31036290
5,60	6	66	28	20	36	SCD621-0560-2-3-145HA03-HP358	31036291
5,80	6	66	28	20	36	SCD621-0580-2-3-145HA03-HP358	31036293
5,90	6	66	28	20	36	SCD621-0590-2-3-145HA03-HP358	31036294
6,00	6	66	28	20	36	SCD621-0600-2-3-145HA03-HP358	31036295
6,10	8	79	34	24	36	SCD621-0610-2-3-145HA03-HP358	31036296
6,20	8	79	34	24	36	SCD621-0620-2-3-145HA03-HP358	31036297
6,30	8	79	34	24	36	SCD621-0630-2-3-145HA03-HP358	31036298
6,40	8	79	34	24	36	SCD621-0640-2-3-145HA03-HP358	31036299
6,50	8	79	34	24	36	SCD621-0650-2-3-145HA03-HP358	31036300
6,60	8	79	34	24	36	SCD621-0660-2-3-145HA03-HP358	31036301
6,80	8	79	34	24	36	SCD621-0680-2-3-145HA03-HP358	31036303
6,90	8	79	34	24	36	SCD621-0690-2-3-145HA03-HP358	31036304
7,00	8	79	34	24	36	SCD621-0700-2-3-145HA03-HP358	31036305
7,15	8	79	41	29	36	SCD621-0715-2-3-145HA03-HP358	31307529

MEGA-Speed-Drill-Steel | Wiertła spiralne z węgla spiekane SCD621 (3xD), wewnętrzne doprowadzenie chłodziwa

Wymiary						Typ chwytu HA	
d ₁ h7	d ₂ h6	l ₁	l ₂	l ₃	l ₄	Specyfikacja	Nr materiałowy
7,30	8	79	41	29	36	SCD621-0730-2-3-145HA03-HP358	31036308
7,40	8	79	41	29	36	SCD621-0740-2-3-145HA03-HP358	31036309
7,50	8	79	41	29	36	SCD621-0750-2-3-145HA03-HP358	31036310
7,60	8	79	41	29	36	SCD621-0760-2-3-145HA03-HP358	31036311
7,70	8	79	41	29	36	SCD621-0770-2-3-145HA03-HP358	31036312
7,80	8	79	41	29	36	SCD621-0780-2-3-145HA03-HP358	31036313
8,00	8	79	41	29	36	SCD621-0800-2-3-145HA03-HP358	31036315
8,20	10	89	47	35	40	SCD621-0820-2-3-145HA03-HP358	31036317
8,50	10	89	47	35	40	SCD621-0850-2-3-145HA03-HP358	31036320
8,60	10	89	47	35	40	SCD621-0860-2-3-145HA03-HP358	31036321
8,70	10	89	47	35	40	SCD621-0870-2-3-145HA03-HP358	31036322
8,80	10	89	47	35	40	SCD621-0880-2-3-145HA03-HP358	31036323
8,90	10	89	47	35	40	SCD621-0890-2-3-145HA03-HP358	31036324
9,00	10	89	47	35	40	SCD621-0900-2-3-145HA03-HP358	31036325
9,10	10	89	47	35	40	SCD621-0910-2-3-145HA03-HP358	31036326
9,20	10	89	47	35	40	SCD621-0920-2-3-145HA03-HP358	31036327
9,30	10	89	47	35	40	SCD621-0930-2-3-145HA03-HP358	31036328
9,40	10	89	47	35	40	SCD621-0940-2-3-145HA03-HP358	31036329
9,50	10	89	47	35	40	SCD621-0950-2-3-145HA03-HP358	31036330
9,60	10	89	47	35	40	SCD621-0960-2-3-145HA03-HP358	31036331
9,80	10	89	47	35	40	SCD621-0980-2-3-145HA03-HP358	31036333
9,90	10	89	47	35	40	SCD621-0990-2-3-145HA03-HP358	31036334
10,00	10	89	47	35	40	SCD621-1000-2-3-145HA03-HP358	31036335
10,20	12	102	55	40	45	SCD621-1020-2-3-145HA03-HP358	31036337
10,30	12	102	55	40	45	SCD621-1030-2-3-145HA03-HP358	31036338
10,50	12	102	55	40	45	SCD621-1050-2-3-145HA03-HP358	31036340
11,00	12	102	55	40	45	SCD621-1100-2-3-145HA03-HP358	31036345
11,20	12	102	55	40	45	SCD621-1120-2-3-145HA03-HP358	31036347
11,50	12	102	55	40	45	SCD621-1150-2-3-145HA03-HP358	31036350
11,80	12	102	55	40	45	SCD621-1180-2-3-145HA03-HP358	31036353
11,90	12	102	55	40	45	SCD621-1190-2-3-145HA03-HP358	31036354
12,00	12	102	55	40	45	SCD621-1200-2-3-145HA03-HP358	31036355
13,00	14	107	60	43	45	SCD621-1300-2-3-145HA03-HP358	31036359
13,80	14	107	60	43	45	SCD621-1380-2-3-145HA03-HP358	31036361
14,00	14	107	60	43	45	SCD621-1400-2-3-145HA03-HP358	31036362
14,50	16	115	65	45	48	SCD621-1450-2-3-145HA03-HP358	31036364
15,00	16	115	65	45	48	SCD621-1500-2-3-145HA03-HP358	31036366
16,00	16	115	65	45	48	SCD621-1600-2-3-145HA03-HP358	31036370
17,00	18	123	73	51	48	SCD621-1700-2-3-145HA03-HP358	31036373
17,50	18	123	73	51	48	SCD621-1750-2-3-145HA03-HP358	31036374
18,00	18	123	73	51	48	SCD621-1800-2-3-145HA03-HP358	31036376
18,50	20	131	79	55	50	SCD621-1850-2-3-145HA03-HP358	31036377
20,00	20	131	79	55	50	SCD621-2000-2-3-145HA03-HP358	31036392

MEGA-Speed-Drill-Steel | Wiertła spiralne z węgla spiekanego SCD621 (3xD), wewnętrzne doprowadzenie chłodziwa

Możliwość konfiguracji parametrów



Średnica:
możliwość wyboru średnicy w
krokach co 0,01 mm



Typ chwytu:
Typ chwytu HB | HE

Specyfikacja:

SCD621-[średnica]-2-3-145[typ chwytu]03-HP358

Przykład:

SCD621-0431-2-3-145HE03-HP358

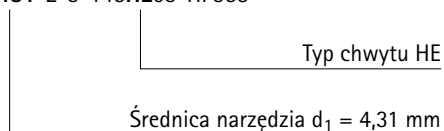

Wymiary typoszeregu z możliwością konfiguracji parametrów

d ₁ min.	d ₁ max.	d ₂ h6	l ₁	l ₂	l ₃	l ₄
3,00	3,70	6	62	20	14	36
3,71	4,70	6	66	24	17	36
4,71	6,00	6	66	28	20	36
6,01	6,80	8	79	34	24	36
6,81	8,00	8	79	41	29	36
8,01	10,00	10	89	47	35	40
10,01	12,00	12	102	55	40	45
12,01	14,00	14	107	60	43	45
14,01	16,00	16	115	65	45	48
16,01	18,00	18	123	73	51	48
18,01	20,00	20	131	79	55	50

Wymiary podano w mm.

Zalecane parametry skrawania - patrz koniec rozdziału.

Wersje specjalne i inne powłoki wg zapytania ofertowego.

MEGA-Speed-Drill-Steel

Wiertła spiralne z węglika spiekanego

SCD621 (5xD), wewnętrzne doprowadzenie chłodziwa, następcą MEGA-Speed-Drill-Uni (SCD22)

Wersja:

Średnica wiertła: 3,00 – 20,00 mm

Tolerancja otworu: \geq IT 9

Materiał skrawający: HP358

Liczba ostrzy: 2

Liczba łysinek: 3

Kąt wierzchołkowy: 145°

Kąt spirali: 30°

Zastosowanie:

Do obróbki z dużymi prędkościami.

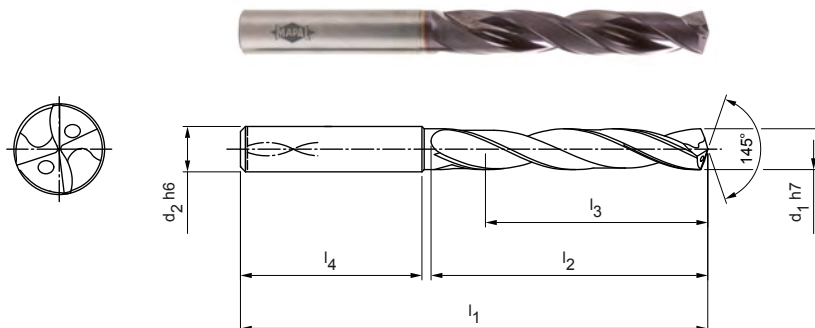

Magazynowa seria preferowana z typem chwytu HA

Wymiary						Typ chwytu HA	
d ₁ h7	d ₂ h6	l ₁	l ₂	l ₃	l ₄	Specyfikacja	Nr materiałowy
3,00	6	66	28	23	36	SCD621-0300-2-3-145HA05-HP358	30966287
3,10	6	66	28	23	36	SCD621-0310-2-3-145HA05-HP358	30966288
3,20	6	66	28	23	36	SCD621-0320-2-3-145HA05-HP358	30966289
3,30	6	66	28	23	36	SCD621-0330-2-3-145HA05-HP358	30966310
3,40	6	66	28	23	36	SCD621-0340-2-3-145HA05-HP358	30966311
3,50	6	66	28	23	36	SCD621-0350-2-3-145HA05-HP358	30959126
3,70	6	66	28	23	36	SCD621-0370-2-3-145HA05-HP358	30966313
3,80	6	74	36	29	36	SCD621-0380-2-3-145HA05-HP358	30966314
4,00	6	74	36	29	36	SCD621-0400-2-3-145HA05-HP358	30966316
4,20	6	74	36	29	36	SCD621-0420-2-3-145HA05-HP358	30966318
4,30	6	74	36	29	36	SCD621-0430-2-3-145HA05-HP358	30966319
4,50	6	74	36	29	36	SCD621-0450-2-3-145HA05-HP358	30966321
4,65	6	74	36	29	36	SCD621-0465-2-3-145HA05-HP358	31307540
4,70	6	74	36	29	36	SCD621-0470-2-3-145HA05-HP358	30966323
4,80	6	82	44	35	36	SCD621-0480-2-3-145HA05-HP358	30966324
4,90	6	82	44	35	36	SCD621-0490-2-3-145HA05-HP358	30966326
5,00	6	82	44	35	36	SCD621-0500-2-3-145HA05-HP358	30966327
5,10	6	82	44	35	36	SCD621-0510-2-3-145HA05-HP358	30966328
5,20	6	82	44	35	36	SCD621-0520-2-3-145HA05-HP358	30966329
5,30	6	82	44	35	36	SCD621-0530-2-3-145HA05-HP358	30966330
5,40	6	82	44	35	36	SCD621-0540-2-3-145HA05-HP358	30966331
5,50	6	82	44	35	36	SCD621-0550-2-3-145HA05-HP358	30966332
5,55	6	82	44	35	36	SCD621-0555-2-3-145HA05-HP358	31307541
5,60	6	82	44	35	36	SCD621-0560-2-3-145HA05-HP358	30966333
5,70	6	82	44	35	36	SCD621-0570-2-3-145HA05-HP358	30966334
5,80	6	82	44	35	36	SCD621-0580-2-3-145HA05-HP358	30966335
5,90	6	82	44	35	36	SCD621-0590-2-3-145HA05-HP358	30966336
6,00	6	82	44	35	36	SCD621-0600-2-3-145HA05-HP358	30966337
6,10	8	91	53	43	36	SCD621-0610-2-3-145HA05-HP358	30966338
6,20	8	91	53	43	36	SCD621-0620-2-3-145HA05-HP358	30966339
6,30	8	91	53	43	36	SCD621-0630-2-3-145HA05-HP358	30966340
6,50	8	91	53	43	36	SCD621-0650-2-3-145HA05-HP358	30966342
6,70	8	91	53	43	36	SCD621-0670-2-3-145HA05-HP358	30966344
6,80	8	91	53	43	36	SCD621-0680-2-3-145HA05-HP358	30966345

MEGA-Speed-Drill-Steel | Wiertła spiralne z węgla spiekane SCD621 (5xD), wewnętrzne doprowadzenie chłodziwa

Wymiary						Typ chwytu HA	
d ₁ h7	d ₂ h6	l ₁	l ₂	l ₃	l ₄	Specyfikacja	Nr materiałowy
6,90	8	91	53	43	36	SCD621-0690-2-3-145HA05-HP358	30966346
7,00	8	91	53	43	36	SCD621-0700-2-3-145HA05-HP358	30966347
7,10	8	91	53	43	36	SCD621-0710-2-3-145HA05-HP358	30966348
7,20	8	91	53	43	36	SCD621-0720-2-3-145HA05-HP358	30966349
7,30	8	91	53	43	36	SCD621-0730-2-3-145HA05-HP358	30966350
7,40	8	91	53	43	36	SCD621-0740-2-3-145HA05-HP358	30966351
7,50	8	91	53	43	36	SCD621-0750-2-3-145HA05-HP358	30966352
7,60	8	91	53	43	36	SCD621-0760-2-3-145HA05-HP358	30966353
7,80	8	91	53	43	36	SCD621-0780-2-3-145HA05-HP358	30966355
8,00	8	91	53	43	36	SCD621-0800-2-3-145HA05-HP358	30948674
8,10	10	103	61	49	40	SCD621-0810-2-3-145HA05-HP358	30966357
8,20	10	103	61	49	40	SCD621-0820-2-3-145HA05-HP358	30966358
8,30	10	103	61	49	40	SCD621-0830-2-3-145HA05-HP358	30966359
8,40	10	103	61	49	40	SCD621-0840-2-3-145HA05-HP358	30966360
8,50	10	103	61	49	40	SCD621-0850-2-3-145HA05-HP358	30959302
8,60	10	103	61	49	40	SCD621-0860-2-3-145HA05-HP358	30966361
8,70	10	89	47	35	40	SCD621-0870-2-3-145HA05-HP358	30812607
8,80	10	103	61	49	40	SCD621-0880-2-3-145HA05-HP358	30966362
9,00	10	103	61	49	40	SCD621-0900-2-3-145HA05-HP358	30966364
9,10	10	103	61	49	40	SCD621-0910-2-3-145HA05-HP358	30966365
9,30	10	103	61	49	40	SCD621-0930-2-3-145HA05-HP358	30966367
9,40	10	103	61	49	40	SCD621-0940-2-3-145HA05-HP358	30966368
9,50	10	103	61	49	40	SCD621-0950-2-3-145HA05-HP358	30966369
9,70	10	103	61	49	40	SCD621-0970-2-3-145HA05-HP358	30958145
9,80	10	103	61	49	40	SCD621-0980-2-3-145HA05-HP358	30959402
9,90	10	103	61	49	40	SCD621-0990-2-3-145HA05-HP358	30966371
10,00	10	103	61	49	40	SCD621-1000-2-3-145HA05-HP358	30948675
10,20	12	118	71	56	45	SCD621-1020-2-3-145HA05-HP358	30966373
10,30	12	118	71	56	45	SCD621-1030-2-3-145HA05-HP358	30966374
10,50	12	118	71	56	45	SCD621-1050-2-3-145HA05-HP358	30966376
11,00	12	118	71	56	45	SCD621-1100-2-3-145HA05-HP358	30966381
11,10	12	118	71	56	45	SCD621-1110-2-3-145HA05-HP358	30966382
11,20	12	118	71	56	45	SCD621-1120-2-3-145HA05-HP358	30966383
11,30	12	118	71	56	45	SCD621-1130-2-3-145HA05-HP358	30966384
11,40	12	118	71	56	45	SCD621-1140-2-3-145HA05-HP358	30966385
11,50	12	118	71	56	45	SCD621-1150-2-3-145HA05-HP358	30966386
11,60	12	118	71	56	45	SCD621-1160-2-3-145HA05-HP358	30966387
11,80	12	118	71	56	45	SCD621-1180-2-3-145HA05-HP358	30966389
11,90	12	118	71	56	45	SCD621-1190-2-3-145HA05-HP358	30966390
12,00	12	118	71	56	45	SCD621-1200-2-3-145HA05-HP358	30948676
12,20	14	124	77	60	45	SCD621-1220-2-3-145HA05-HP358	30966391
12,50	14	124	77	60	45	SCD621-1250-2-3-145HA05-HP358	30966392
12,80	14	124	77	60	45	SCD621-1280-2-3-145HA05-HP358	30980599
13,00	14	124	77	60	45	SCD621-1300-2-3-145HA05-HP358	30966393
13,50	14	124	77	60	45	SCD621-1350-2-3-145HA05-HP358	30966394
13,80	14	124	77	60	45	SCD621-1380-2-3-145HA05-HP358	30966395
14,00	14	124	77	60	45	SCD621-1400-2-3-145HA05-HP358	30966396
14,20	16	133	83	63	48	SCD621-1420-2-3-145HA05-HP358	30966397
14,50	16	133	83	63	48	SCD621-1450-2-3-145HA05-HP358	30966398
15,00	16	133	83	63	48	SCD621-1500-2-3-145HA05-HP358	30966400
15,20	16	133	83	63	48	SCD621-1520-2-3-145HA05-HP358	30966401
15,50	16	133	83	63	48	SCD621-1550-2-3-145HA05-HP358	30966402
16,00	16	133	83	63	48	SCD621-1600-2-3-145HA05-HP358	30966404
16,50	18	143	93	71	48	SCD621-1650-2-3-145HA05-HP358	30966405
17,00	18	143	93	71	48	SCD621-1700-2-3-145HA05-HP358	30966407
17,50	18	143	93	71	48	SCD621-1750-2-3-145HA05-HP358	30966408

Ciąg dalszy na następnej stronie.

MEGA-Speed-Drill-Steel | Wiertła spiralne z węgla spiekanego SCD621 (5xD), wewnętrzne doprowadzenie chłodziwa

Wymiary						Typ chwytu HA	
d ₁ h7	d ₂ h6	l ₁	l ₂	l ₃	l ₄	Specyfikacja	Nr materiałowy
18,00	18	143	93	71	48	SCD621-1800-2-3-145HA05-HP358	30966410
18,50	20	153	101	77	50	SCD621-1850-2-3-145HA05-HP358	30966411
19,80	20	153	101	77	50	SCD621-1980-2-3-145HA05-HP358	30966415
20,00	20	153	101	77	50	SCD621-2000-2-3-145HA05-HP358	30966416

Możliwość konfiguracji parametrów



Średnica:
możliwość wyboru średnicy w
krokach co 0,01 mm



Typ chwytu:
Typ chwytu: HB | HE

Specyfikacja:

SCD621-[średnica]-3-3-140[typ chwytu]05-HP358

Przykład:

SCD621-0431-2-3-140HE05-HP358

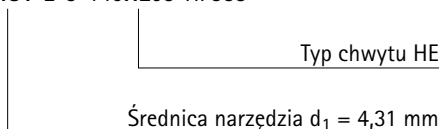

Wymiary typoszeregu z możliwością konfiguracji parametrów

d ₁ min.	d ₁ max.	d ₂ h6	l ₁	l ₂	l ₃	l ₄
3,00	3,70	6	66	28	23	36
3,71	4,70	6	74	36	29	36
4,71	6,00	6	82	44	35	36
6,01	6,80	8	91	53	43	36
6,81	8,00	8	91	53	43	36
8,01	9,00	10	103	61	49	40
9,01	10,00	10	103	61	49	40
10,01	11,00	12	118	71	56	45
11,01	12,00	12	118	71	56	45
12,01	14,00	14	124	77	60	45
14,01	16,00	16	133	83	63	48
16,01	18,00	18	143	93	71	48
18,01	20,00	20	153	101	77	50

Wymiary podano w mm.

Zalecane parametry skrawania - patrz koniec rozdziału.

Wersje specjalne i inne powłoki wg zapytania ofertowego.

MEGA-Speed-Drill-Steel

Wiertła spiralne z węgla spiekane

SCD621 (8xD), wewnętrzne doprowadzenie chłodziwa, następcza MEGA-Speed-Drill-Uni (SCD22)

Wersja:

Średnica wiertła: 3,00 – 20,00 mm
 Tolerancja otworu: IT 9 (osiągalne)
 Materiał skrawający: HP358
 Liczba ostrzy: 2
 Liczba łysinek: 3
 Kąt wierzchołkowy: 145°
 Kąt spirali: 30°

Zastosowanie:

Do obróbki z dużymi prędkościami.

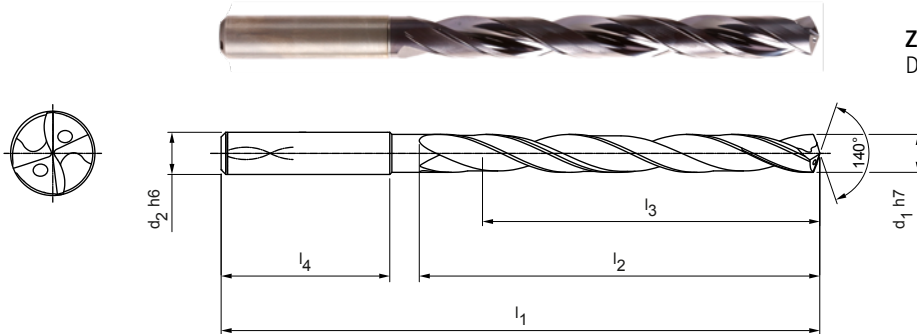

Magazynowa seria preferowana z typem chwytu HA

Wymiary						Typ chwytu HA	
d ₁ h7	d ₂ h6	l ₁	l ₂	l ₃	l ₄	Specyfikacja	Nr materiałowy
3,00	6	72	34	29	36	SCD621-0300-2-3-145HA08-HP358	31036147
3,10	6	72	34	29	36	SCD621-0310-2-3-145HA08-HP358	31036148
3,20	6	72	34	29	36	SCD621-0320-2-3-145HA08-HP358	31036149
3,30	6	72	34	29	36	SCD621-0330-2-3-145HA08-HP358	31036150
3,40	6	72	34	29	36	SCD621-0340-2-3-145HA08-HP358	31036151
3,50	6	72	34	29	36	SCD621-0350-2-3-145HA08-HP358	31036152
3,70	6	72	34	29	36	SCD621-0370-2-3-145HA08-HP358	31036154
4,00	6	81	43	36	36	SCD621-0400-2-3-145HA08-HP358	31036157
4,10	6	81	43	36	36	SCD621-0410-2-3-145HA08-HP358	31036158
4,20	6	81	43	36	36	SCD621-0420-2-3-145HA08-HP358	31036159
4,30	6	81	43	36	36	SCD621-0430-2-3-145HA08-HP358	31036160
4,50	6	81	43	36	36	SCD621-0450-2-3-145HA08-HP358	31036162
4,65	6	81	43	36	36	SCD621-0465-2-3-145HA08-HP358	31307542
4,80	6	95	57	48	36	SCD621-0480-2-3-145HA08-HP358	31036165
4,90	6	95	57	48	36	SCD621-0490-2-3-145HA08-HP358	31036166
5,00	6	95	57	48	36	SCD621-0500-2-3-145HA08-HP358	31036167
5,10	6	95	57	48	36	SCD621-0510-2-3-145HA08-HP358	31036168
5,20	6	95	57	48	36	SCD621-0520-2-3-145HA08-HP358	31036169
5,40	6	95	57	48	36	SCD621-0540-2-3-145HA08-HP358	31036171
5,50	6	95	57	48	36	SCD621-0550-2-3-145HA08-HP358	31036172
5,55	6	95	57	48	36	SCD621-0555-2-3-145HA08-HP358	31307543
5,60	6	95	57	48	36	SCD621-0560-2-3-145HA08-HP358	31036173
5,80	6	95	57	48	36	SCD621-0580-2-3-145HA08-HP358	31036175
5,90	6	95	57	48	36	SCD621-0590-2-3-145HA08-HP358	31036176
6,00	6	95	57	48	36	SCD621-0600-2-3-145HA08-HP358	31036177
6,10	8	114	76	64	36	SCD621-0610-2-3-145HA08-HP358	31036178
6,20	8	114	76	64	36	SCD621-0620-2-3-145HA08-HP358	31036179
6,50	8	114	76	64	36	SCD621-0650-2-3-145HA08-HP358	31036182
6,80	8	114	76	64	36	SCD621-0680-2-3-145HA08-HP358	31036185
6,90	8	114	76	64	36	SCD621-0690-2-3-145HA08-HP358	31036186
7,00	8	114	76	64	36	SCD621-0700-2-3-145HA08-HP358	31036187
7,50	8	114	76	64	36	SCD621-0750-2-3-145HA08-HP358	31036192
7,80	8	114	76	64	36	SCD621-0780-2-3-145HA08-HP358	31036195
8,00	8	114	76	64	36	SCD621-0800-2-3-145HA08-HP358	31036197
8,10	10	142	95	80	40	SCD621-0810-2-3-145HA08-HP358	31036198

MEGA-Speed-Drill-Steel | Wiertła spiralne z węgla spiekane SCD621 (8xD), wewnętrzne doprowadzenie chłodziwa

Wymiary						Typ chwytu HA	
d ₁ h7	d ₂ h6	l ₁	l ₂	l ₃	l ₄	Specyfikacja	Nr materiałowy
8,50	10	142	95	80	40	SCD621-0850-2-3-145HA08-HP358	31036202
9,00	10	142	95	80	40	SCD621-0900-2-3-145HA08-HP358	31036207
9,50	10	142	95	80	40	SCD621-0950-2-3-145HA08-HP358	31036212
9,80	10	142	95	80	40	SCD621-0980-2-3-145HA08-HP358	31036215
10,00	10	142	95	80	40	SCD621-1000-2-3-145HA08-HP358	31036217
10,20	12	162	114	96	45	SCD621-1020-2-3-145HA08-HP358	31036219
10,30	12	162	114	96	45	SCD621-1030-2-3-145HA08-HP358	31036220
10,50	12	162	114	96	45	SCD621-1050-2-3-145HA08-HP358	31036222
11,00	12	162	114	96	45	SCD621-1100-2-3-145HA08-HP358	31036227
11,80	12	162	114	96	45	SCD621-1180-2-3-145HA08-HP358	31036235
12,00	12	162	114	96	45	SCD621-1200-2-3-145HA08-HP358	31036237
12,50	14	178	133	112	45	SCD621-1250-2-3-145HA08-HP358	31036239
13,00	14	178	133	112	45	SCD621-1300-2-3-145HA08-HP358	31036241
13,50	14	178	133	112	45	SCD621-1350-2-3-145HA08-HP358	31036242
14,00	14	178	133	112	45	SCD621-1400-2-3-145HA08-HP358	31036244
15,00	16	203	152	128	48	SCD621-1500-2-3-145HA08-HP358	31036248
15,80	16	203	152	128	48	SCD621-1580-2-3-145HA08-HP358	31036251
16,00	16	203	152	128	48	SCD621-1600-2-3-145HA08-HP358	31036252
19,00	20	243	190	160	50	SCD621-1900-2-3-145HA08-HP358	31036261
19,80	20	243	190	160	50	SCD621-1980-2-3-145HA08-HP358	31036263

Możliwość konfiguracji parametrów



Średnica:
możliwość wyboru średnicy w
krokach co 0,01 mm





Typ chwytu:
Typ chwytu: HB | HE

Specyfikacja:
SCD621-[średnica]-2-3-145[typ chwytu]08-HP358

Przykład:

SCD621-0431-2-3-145HE08-HP358

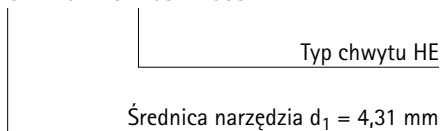

Wymiary typoszeregu z możliwością konfiguracji parametrów

d ₁ min.	d ₁ max.	d ₂ h6	l ₁	l ₂	l ₃	l ₄
3,00	3,70	6	72	34	29	36
3,71	4,70	6	81	43	36	36
4,71	6,00	6	95	57	48	36
6,01	6,80	8	114	76	64	36
6,81	8,00	8	114	76	64	36
8,01	9,00	10	142	95	80	40
9,01	10,00	10	142	95	80	40
10,01	11,00	12	162	114	96	45
11,01	12,00	12	162	114	96	45
12,01	14,00	14	178	133	112	45
14,01	16,00	16	203	152	128	48
16,01	18,00	18	222	171	144	48
18,01	20,00	20	243	190	160	50

Wymiary podano w mm.

Zalecane parametry skrawania - patrz koniec rozdziału.

Wersje specjalne i inne powłoki wg zapytania ofertowego.

MEGA-Speed-Drill-Steel

Wiertła spiralne z węgla spiekanego

SCD621 (12xD), wewnętrzne doprowadzenie chłodziwa, następcza MEGA-Speed-Drill-Uni (SCD22)

Wersja:

- Średnica wiertła: 3,00 – 20,00 mm
- Tolerancja otworu: \geq IT 9
- Materiał skrawający: HP358
- Liczba ostrzy: 2
- Liczba łysinek: 3
- Kąt wierzchołkowy: 145°
- Kąt spirali: 30°

Zastosowanie:

Do obróbki z dużymi prędkościami.

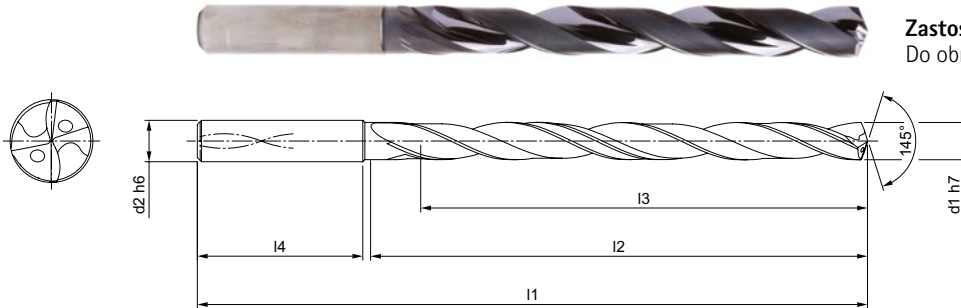

Magazynowa seria preferowana z typem chwytu HA

Wymiary						Typ chwytu HA	
d ₁ h7	d ₂ h6	l ₁	l ₂	l ₃	l ₄	Specyfikacja	Nr materiałowy
3,00	6	92	54	48	36	SCD621-0300-2-3-145HA12-HP358	31239148
3,20	6	92	54	48	36	SCD621-0320-2-3-145HA12-HP358	31239150
3,30	6	92	54	48	36	SCD621-0330-2-3-145HA12-HP358	31239151
3,40	6	92	54	48	36	SCD621-0340-2-3-145HA12-HP358	31239152
3,50	6	92	54	48	36	SCD621-0350-2-3-145HA12-HP358	31239153
3,70	6	92	54	48	36	SCD621-0370-2-3-145HA12-HP358	31239155
4,00	6	102	64	58	36	SCD621-0400-2-3-145HA12-HP358	31239158
4,10	6	102	64	58	36	SCD621-0410-2-3-145HA12-HP358	31239159
4,20	6	102	64	58	36	SCD621-0420-2-3-145HA12-HP358	31239160
4,30	6	102	64	58	36	SCD621-0430-2-3-145HA12-HP358	31239161
4,50	6	102	64	58	36	SCD621-0450-2-3-145HA12-HP358	31239163
4,80	6	116	78	70	36	SCD621-0480-2-3-145HA12-HP358	31239166
5,00	6	116	78	70	36	SCD621-0500-2-3-145HA12-HP358	31239168
5,10	6	116	78	70	36	SCD621-0510-2-3-145HA12-HP358	31239169
5,20	6	116	78	70	36	SCD621-0520-2-3-145HA12-HP358	31239170
5,40	6	116	78	70	36	SCD621-0540-2-3-145HA12-HP358	31239172
5,50	6	116	78	70	36	SCD621-0550-2-3-145HA12-HP358	31239173
5,80	6	116	78	70	36	SCD621-0580-2-3-145HA12-HP358	31239176
6,00	6	116	78	70	36	SCD621-0600-2-3-145HA12-HP358	31239178
6,10	8	146	108	94	36	SCD621-0610-2-3-145HA12-HP358	31239179
6,50	8	146	108	94	36	SCD621-0650-2-3-145HA12-HP358	31239183
6,80	8	146	108	94	36	SCD621-0680-2-3-145HA12-HP358	31239186
7,00	8	146	108	94	36	SCD621-0700-2-3-145HA12-HP358	31239188
7,50	8	146	108	94	36	SCD621-0750-2-3-145HA12-HP358	31239193
7,80	8	146	108	94	36	SCD621-0780-2-3-145HA12-HP358	31239196
8,00	8	146	108	94	36	SCD621-0800-2-3-145HA12-HP358	31239198
8,50	10	162	120	110	40	SCD621-0850-2-3-145HA12-HP358	31239203
9,00	10	162	120	110	40	SCD621-0900-2-3-145HA12-HP358	31239208
9,50	10	162	120	110	40	SCD621-0950-2-3-145HA12-HP358	31239213
9,80	10	162	120	110	40	SCD621-0980-2-3-145HA12-HP358	31239216
10,00	10	162	120	110	40	SCD621-1000-2-3-145HA12-HP358	31239218
10,20	12	204	156	142	45	SCD621-1020-2-3-145HA12-HP358	31239220
10,50	12	204	156	142	45	SCD621-1050-2-3-145HA12-HP358	31239223
11,00	12	204	156	142	45	SCD621-1100-2-3-145HA12-HP358	31239228
11,80	12	204	156	142	45	SCD621-1180-2-3-145HA12-HP358	31239236

MEGA-Speed-Drill-Steel | Wiertła spiralne z węgla spiekane SCD621 (12xD), wewnętrzne doprowadzenie chłodziwa

Wymiary						Typ chwytu HA	
d ₁ h7	d ₂ h6	l ₁	l ₂	l ₃	l ₄	Specyfikacja	Nr materiałowy
12,00	12	204	156	142	45	SCD621-1200-2-3-145HA12-HP358	31239238
12,50	14	230	182	166	45	SCD621-1250-2-3-145HA12-HP358	31239240
13,00	14	230	182	166	45	SCD621-1300-2-3-145HA12-HP358	31239242
13,50	14	230	182	166	45	SCD621-1350-2-3-145HA12-HP358	31239243
14,00	14	230	182	166	45	SCD621-1400-2-3-145HA12-HP358	31239245
15,00	16	260	208	192	48	SCD621-1500-2-3-145HA12-HP358	31239248
16,00	16	260	208	192	48	SCD621-1600-2-3-145HA12-HP358	31239253

Możliwość konfiguracji parametrów



Średnica:
możliwość wyboru średnicy w krokach
co 0,01 mm





Typ chwytu:
Typ chwytu: HB | HE

Specyfikacja:
SCD621-[średnica]-2-3-145[typ chwytu]12-HP358

Przykład:
SCD621-0431-2-3-145HE12-HP358

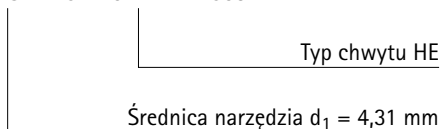

Wymiary typoszeregu z możliwością konfiguracji parametrów

d ₁ min.	d ₁ max.	d ₂ h6	l ₁	l ₂	l ₃	l ₄
3,00	3,70	6	92	54	48	36
3,71	4,70	6	102	64	58	36
4,71	6,00	6	116	78	70	36
6,01	6,80	8	146	108	94	36
6,81	8,00	8	146	108	94	36
8,01	9,00	10	162	120	110	40
9,01	10,00	10	162	120	110	40
10,01	11,00	12	204	156	142	45
11,01	12,00	12	204	156	142	45
12,01	14,00	14	230	182	166	45
14,01	16,00	16	260	208	192	48
16,01	18,00	18	285	234	216	48
18,01	20,00	20	310	258	240	50

Wymiary podano w mm.

Zalecane parametry skrawania - patrz koniec rozdziału.

Wersje specjalne i inne powłoki wg zapytania ofertowego.

MEGA-180°-Drill

Wiertła spiralne z węgla spiekane
SCD231 (3xD), wewnętrzne doprowadzenie chłodziwa

Wersja:
Średnica wiertła: 3,00 – 20,00 mm
Tolerancja otworu: \geq IT 9
Materiał skrawający: HP230
Liczba ostrzy: 2
Liczba tyśnek: 4
Kąt wierzchołkowy: 180°
Kąt spirali: 30°

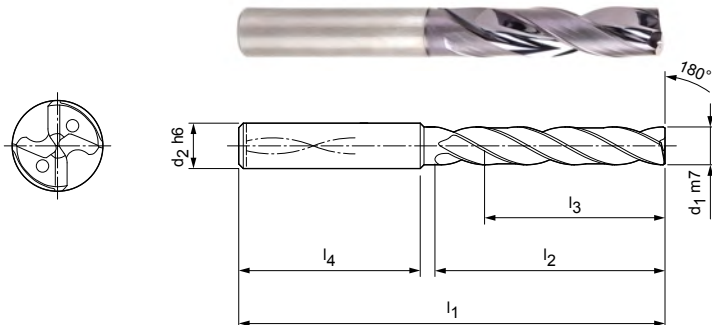

Magazynowa seria preferowana z typem chwytu HA

Wymiary						Typ chwytu HA	
d ₁ m7	d ₂ h6	l ₁	l ₂	l ₃	l ₄	Specyfikacja	Nr materiałowy
3,00	6	62	20	14	36	SCD231-0300-2-4-180HA03-HP230	30382647
3,10	6	62	20	14	36	SCD231-0310-2-4-180HA03-HP230	30382648
3,20	6	62	20	14	36	SCD231-0320-2-4-180HA03-HP230	30382649
3,30	6	62	20	14	36	SCD231-0330-2-4-180HA03-HP230	30382650
3,40	6	62	20	14	36	SCD231-0340-2-4-180HA03-HP230	30382651
3,50	6	62	20	14	36	SCD231-0350-2-4-180HA03-HP230	30382652
3,60	6	62	20	14	36	SCD231-0360-2-4-180HA03-HP230	30382653
3,70	6	62	20	14	36	SCD231-0370-2-4-180HA03-HP230	30382654
3,80	6	66	24	17	36	SCD231-0380-2-4-180HA03-HP230	30382655
3,90	6	66	24	17	36	SCD231-0390-2-4-180HA03-HP230	30382656
4,00	6	66	24	17	36	SCD231-0400-2-4-180HA03-HP230	30382657
4,10	6	66	24	17	36	SCD231-0410-2-4-180HA03-HP230	30382658
4,20	6	66	24	17	36	SCD231-0420-2-4-180HA03-HP230	30382659
4,30	6	66	24	17	36	SCD231-0430-2-4-180HA03-HP230	30382660
4,40	6	66	24	17	36	SCD231-0440-2-4-180HA03-HP230	30382661
4,50	6	66	24	17	36	SCD231-0450-2-4-180HA03-HP230	30382662
4,60	6	66	24	17	36	SCD231-0460-2-4-180HA03-HP230	30382663
4,65	6	66	24	17	36	SCD231-0465-2-4-180HA03-HP230	30382664
4,70	6	66	24	17	36	SCD231-0470-2-4-180HA03-HP230	30382665
4,80	6	66	28	20	36	SCD231-0480-2-4-180HA03-HP230	30382666
4,90	6	66	28	20	36	SCD231-0490-2-4-180HA03-HP230	30382667
5,00	6	66	28	20	36	SCD231-0500-2-4-180HA03-HP230	30382668
5,10	6	66	28	20	36	SCD231-0510-2-4-180HA03-HP230	30382669
5,20	6	66	28	20	36	SCD231-0520-2-4-180HA03-HP230	30382670
5,30	6	66	28	20	36	SCD231-0530-2-4-180HA03-HP230	30382671
5,40	6	66	28	20	36	SCD231-0540-2-4-180HA03-HP230	30382672
5,50	6	66	28	20	36	SCD231-0550-2-4-180HA03-HP230	30382673
5,55	6	66	28	20	36	SCD231-0555-2-4-180HA03-HP230	30382674
5,60	6	66	28	20	36	SCD231-0560-2-4-180HA03-HP230	30382675
5,70	6	66	28	20	36	SCD231-0570-2-4-180HA03-HP230	30382676
5,80	6	66	28	20	36	SCD231-0580-2-4-180HA03-HP230	30382677
5,90	6	66	28	20	36	SCD231-0590-2-4-180HA03-HP230	30382678
6,00	6	66	28	20	36	SCD231-0600-2-4-180HA03-HP230	30382679
6,10	8	79	34	24	36	SCD231-0610-2-4-180HA03-HP230	30382680
6,20	8	79	34	24	36	SCD231-0620-2-4-180HA03-HP230	30382681

MEGA-180°-Drill | Wiertła spiralne z węgla spiekanego SCD231 (3xD), wewnętrzne doprowadzenie chłodziwa

Wymiary						Typ chwytu HA	
d ₁ m7	d ₂ h6	l ₁	l ₂	l ₃	l ₄	Specyfikacja	Nr materiałowy
6,30	8	79	34	24	36	SCD231-0630-2-4-180HA03-HP230	30382682
6,40	8	79	34	24	36	SCD231-0640-2-4-180HA03-HP230	30382683
6,50	8	79	34	24	36	SCD231-0650-2-4-180HA03-HP230	30382684
6,60	8	79	34	24	36	SCD231-0660-2-4-180HA03-HP230	30382685
6,70	8	79	34	24	36	SCD231-0670-2-4-180HA03-HP230	30382686
6,80	8	79	34	24	36	SCD231-0680-2-4-180HA03-HP230	30382687
6,90	8	79	34	24	36	SCD231-0690-2-4-180HA03-HP230	30382688
7,00	8	79	34	24	36	SCD231-0700-2-4-180HA03-HP230	30382689
7,10	8	79	41	29	36	SCD231-0710-2-4-180HA03-HP230	30382690
7,20	8	79	41	29	36	SCD231-0720-2-4-180HA03-HP230	30382691
7,30	8	79	41	29	36	SCD231-0730-2-4-180HA03-HP230	30382692
7,40	8	79	41	29	36	SCD231-0740-2-4-180HA03-HP230	30382693
7,50	8	79	41	29	36	SCD231-0750-2-4-180HA03-HP230	30382694
7,60	8	79	41	29	36	SCD231-0760-2-4-180HA03-HP230	30382695
7,70	8	79	41	29	36	SCD231-0770-2-4-180HA03-HP230	30382696
7,80	8	79	41	29	36	SCD231-0780-2-4-180HA03-HP230	30382697
7,90	8	79	41	29	36	SCD231-0790-2-4-180HA03-HP230	30382698
8,00	8	79	41	29	36	SCD231-0800-2-4-180HA03-HP230	30382699
8,10	10	89	47	35	40	SCD231-0810-2-4-180HA03-HP230	30382700
8,20	10	89	47	35	40	SCD231-0820-2-4-180HA03-HP230	30382701
8,30	10	89	47	35	40	SCD231-0830-2-4-180HA03-HP230	30382702
8,40	10	89	47	35	40	SCD231-0840-2-4-180HA03-HP230	30382703
8,50	10	89	47	35	40	SCD231-0850-2-4-180HA03-HP230	30382704
8,60	10	89	47	35	40	SCD231-0860-2-4-180HA03-HP230	30382705
8,70	10	89	47	35	40	SCD231-0870-2-4-180HA03-HP230	30382706
8,80	10	89	47	35	40	SCD231-0880-2-4-180HA03-HP230	30382707
8,90	10	89	47	35	40	SCD231-0890-2-4-180HA03-HP230	30382708
9,00	10	89	47	35	40	SCD231-0900-2-4-180HA03-HP230	30382709
9,10	10	89	47	35	40	SCD231-0910-2-4-180HA03-HP230	30382710
9,20	10	89	47	35	40	SCD231-0920-2-4-180HA03-HP230	30382711
9,30	10	89	47	35	40	SCD231-0930-2-4-180HA03-HP230	30382712
9,40	10	89	47	35	40	SCD231-0940-2-4-180HA03-HP230	30382713
9,50	10	89	47	35	40	SCD231-0950-2-4-180HA03-HP230	30382714
9,60	10	89	47	35	40	SCD231-0960-2-4-180HA03-HP230	30382715
9,70	10	89	47	35	40	SCD231-0970-2-4-180HA03-HP230	30382716
9,80	10	89	47	35	40	SCD231-0980-2-4-180HA03-HP230	30382717
9,90	10	89	47	35	40	SCD231-0990-2-4-180HA03-HP230	30382718
10,00	10	89	47	35	40	SCD231-1000-2-4-180HA03-HP230	30382719
10,10	12	100	53	38	45	SCD231-1010-2-4-180HA03-HP230	30382720
10,20	12	100	53	38	45	SCD231-1020-2-4-180HA03-HP230	30382721
10,30	12	100	53	38	45	SCD231-1030-2-4-180HA03-HP230	30382722
10,40	12	100	53	38	45	SCD231-1040-2-4-180HA03-HP230	30382723
10,50	12	100	53	38	45	SCD231-1050-2-4-180HA03-HP230	30382724
10,60	12	100	53	38	45	SCD231-1060-2-4-180HA03-HP230	30382725
10,70	12	100	53	38	45	SCD231-1070-2-4-180HA03-HP230	30382726
10,80	12	100	53	38	45	SCD231-1080-2-4-180HA03-HP230	30382727
11,00	12	100	53	38	45	SCD231-1100-2-4-180HA03-HP230	30382729
11,10	12	100	53	38	45	SCD231-1110-2-4-180HA03-HP230	30382730
11,20	12	100	53	38	45	SCD231-1120-2-4-180HA03-HP230	30382731
11,30	12	100	53	38	45	SCD231-1130-2-4-180HA03-HP230	30382732
11,40	12	100	53	38	45	SCD231-1140-2-4-180HA03-HP230	30382733
11,50	12	100	53	38	45	SCD231-1150-2-4-180HA03-HP230	30382734
11,60	12	100	53	38	45	SCD231-1160-2-4-180HA03-HP230	30382735
11,70	12	100	53	38	45	SCD231-1170-2-4-180HA03-HP230	30382736
11,80	12	100	53	38	45	SCD231-1180-2-4-180HA03-HP230	30382737
11,90	12	100	53	38	45	SCD231-1190-2-4-180HA03-HP230	30382738
12,00	12	100	53	38	45	SCD231-1200-2-4-180HA03-HP230	30382739

MEGA-180°-Drill | Wiertła spiralne z węgla spiekanego SCD231 (3xD), wewnętrzne doprowadzenie chłodziwa

Wymiary						Typ chwytu HA	
d ₁ m7	d ₂ h6	l ₁	l ₂	l ₃	l ₄	Specyfikacja	Nr materiałowy
12,50	14	105	58	41	45	SCD231-1250-2-4-180HA03-HP230	30382740
12,70	14	105	58	41	45	SCD231-1270-2-4-180HA03-HP230	30852019
12,80	14	105	58	41	45	SCD231-1280-2-4-180HA03-HP230	30382741
13,00	14	105	58	41	45	SCD231-1300-2-4-180HA03-HP230	30382742
13,50	14	105	58	41	45	SCD231-1350-2-4-180HA03-HP230	30382743
13,80	14	105	58	41	45	SCD231-1380-2-4-180HA03-HP230	30382744
14,00	14	105	58	41	45	SCD231-1400-2-4-180HA03-HP230	30382745
14,50	16	113	63	43	48	SCD231-1450-2-4-180HA03-HP230	30382746
14,80	16	113	63	43	48	SCD231-1480-2-4-180HA03-HP230	30382747
15,00	16	113	63	43	48	SCD231-1500-2-4-180HA03-HP230	30382748
15,50	16	113	63	43	48	SCD231-1550-2-4-180HA03-HP230	30382749
15,80	16	113	63	43	48	SCD231-1580-2-4-180HA03-HP230	30382750
16,00	16	113	63	43	48	SCD231-1600-2-4-180HA03-HP230	30382751
16,50	18	121	71	49	48	SCD231-1650-2-4-180HA03-HP230	30382752
16,80	18	121	71	49	48	SCD231-1680-2-4-180HA03-HP230	30382753
17,00	18	121	71	49	48	SCD231-1700-2-4-180HA03-HP230	30382754
17,50	18	121	71	49	48	SCD231-1750-2-4-180HA03-HP230	30382755
18,00	18	121	71	49	48	SCD231-1800-2-4-180HA03-HP230	30382757
18,50	20	129	77	53	50	SCD231-1850-2-4-180HA03-HP230	30382758
18,80	20	129	77	53	50	SCD231-1880-2-4-180HA03-HP230	30382759
19,00	20	129	77	53	50	SCD231-1900-2-4-180HA03-HP230	30382760
19,50	20	129	77	53	50	SCD231-1950-2-4-180HA03-HP230	30382761
20,00	20	129	77	53	50	SCD231-2000-2-4-180HA03-HP230	30382763

Możliwość konfiguracji parametrów



Średnica:
możliwość wyboru średnicy w krokach
co 0,01 mm





Typ chwytu:
Typ chwytu: HB | HE

Specyfikacja:
SCD231-[średnica]-2-4-180[typ chwytu]03-HP230

Przykład:

SCD231-0431-2-4-180HE03-HP230

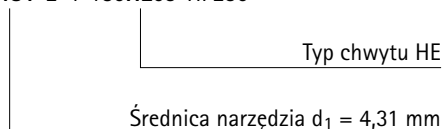

Wymiary typoszeregu z możliwością konfiguracji parametrów

d ₁ min.	d ₁ max.	d ₂ h6	l ₁	l ₂	l ₃	l ₄
3,00	3,70	6	62	20	14	36
3,71	4,70	6	66	24	17	36
4,71	6,00	6	66	28	20	36
6,01	6,80	8	79	34	24	36
6,81	8,00	8	79	41	29	36
8,01	10,00	10	89	47	35	40
10,01	12,00	12	100	53	38	45
12,01	14,00	14	105	58	41	45
14,01	16,00	16	113	63	43	48
16,01	18,00	18	121	71	49	48
18,01	20,00	20	129	77	53	50

Wymiary podano w mm.

Zalecane parametry skrawania - patrz koniec rozdziału.

Wersje specjalne i inne powłoki wg zapytania ofertowego.

MEGA-180°-Drill

Wiertła spiralne z węgla spiekane
SCD231 (5xD), wewnętrzne doprowadzenie chłodziwa

Wersja:

Średnica wiertła: 3,00 – 20,00 mm
Tolerancja otworu: \geq IT 9
Materiał skrawający: HP230
Liczba ostrzy: 2
Liczba tyselek: 4
Kąt wierzchołkowy: 180°
Kąt spirali: 30°

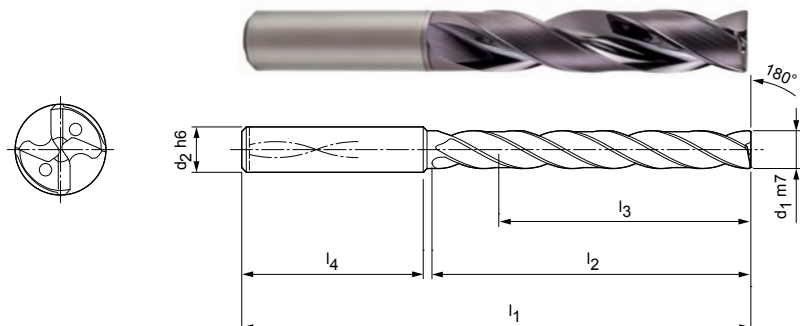

Magazynowa seria preferowana z typem chwytu HA

Wymiary						Typ chwytu HA	
d ₁ m7	d ₂ h6	l ₁	l ₂	l ₃	l ₄	Specyfikacja	Nr materiałowy
3,00	6	66	28	23	36	SCD231-0300-2-4-180HA05-HP230	30382764
3,10	6	66	28	23	36	SCD231-0310-2-4-180HA05-HP230	30382765
3,20	6	66	28	23	36	SCD231-0320-2-4-180HA05-HP230	30382766
3,30	6	66	28	23	36	SCD231-0330-2-4-180HA05-HP230	30382767
3,40	6	66	28	23	36	SCD231-0340-2-4-180HA05-HP230	30382768
3,50	6	66	28	23	36	SCD231-0350-2-4-180HA05-HP230	30382769
3,60	6	66	28	23	36	SCD231-0360-2-4-180HA05-HP230	30382770
3,70	6	66	28	23	36	SCD231-0370-2-4-180HA05-HP230	30382771
3,80	6	74	36	29	36	SCD231-0380-2-4-180HA05-HP230	30382772
3,90	6	74	36	29	36	SCD231-0390-2-4-180HA05-HP230	30382773
4,00	6	74	36	29	36	SCD231-0400-2-4-180HA05-HP230	30382774
4,10	6	74	36	29	36	SCD231-0410-2-4-180HA05-HP230	30382775
4,20	6	74	36	29	36	SCD231-0420-2-4-180HA05-HP230	30382776
4,30	6	74	36	29	36	SCD231-0430-2-4-180HA05-HP230	30382777
4,40	6	74	36	29	36	SCD231-0440-2-4-180HA05-HP230	30382778
4,50	6	74	36	29	36	SCD231-0450-2-4-180HA05-HP230	30382779
4,60	6	74	36	29	36	SCD231-0460-2-4-180HA05-HP230	30382780
4,80	6	82	44	35	36	SCD231-0480-2-4-180HA05-HP230	30382783
4,90	6	82	44	35	36	SCD231-0490-2-4-180HA05-HP230	30382784
5,00	6	82	44	35	36	SCD231-0500-2-4-180HA05-HP230	30382785
5,10	6	82	44	35	36	SCD231-0510-2-4-180HA05-HP230	30382786
5,20	6	82	44	35	36	SCD231-0520-2-4-180HA05-HP230	30382787
5,30	6	82	44	35	36	SCD231-0530-2-4-180HA05-HP230	30382788
5,40	6	82	44	35	36	SCD231-0540-2-4-180HA05-HP230	30382789
5,50	6	82	44	35	36	SCD231-0550-2-4-180HA05-HP230	30382790
5,55	6	82	44	35	36	SCD231-0555-2-4-180HA05-HP230	30382791
5,60	6	82	44	35	36	SCD231-0560-2-4-180HA05-HP230	30382792
5,70	6	82	44	35	36	SCD231-0570-2-4-180HA05-HP230	30382793
5,80	6	82	44	35	36	SCD231-0580-2-4-180HA05-HP230	30382794
5,90	6	82	44	35	36	SCD231-0590-2-4-180HA05-HP230	30382795
6,00	6	82	44	35	36	SCD231-0600-2-4-180HA05-HP230	30382796
6,10	8	91	53	43	36	SCD231-0610-2-4-180HA05-HP230	30382797
6,20	8	91	53	43	36	SCD231-0620-2-4-180HA05-HP230	30382798
6,30	8	91	53	43	36	SCD231-0630-2-4-180HA05-HP230	30382799
6,40	8	91	53	43	36	SCD231-0640-2-4-180HA05-HP230	30382800

MEGA-180°-Drill | Wiertła spiralne z węgla spiekanego SCD231 (5xD), wewnętrzne doprowadzenie chłodziwa

Wymiary						Typ chwytu HA	
d ₁ m7	d ₂ h6	l ₁	l ₂	l ₃	l ₄	Specyfikacja	Nr materiałowy
6,50	8	91	53	43	36	SCD231-0650-2-4-180HA05-HP230	30382801
6,60	8	91	53	43	36	SCD231-0660-2-4-180HA05-HP230	30382802
6,70	8	91	53	43	36	SCD231-0670-2-4-180HA05-HP230	30382803
6,80	8	91	53	43	36	SCD231-0680-2-4-180HA05-HP230	30382804
6,90	8	91	53	43	36	SCD231-0690-2-4-180HA05-HP230	30382805
7,00	8	91	53	43	36	SCD231-0700-2-4-180HA05-HP230	30382806
7,10	8	91	53	43	36	SCD231-0710-2-4-180HA05-HP230	30382807
7,20	8	91	53	43	36	SCD231-0720-2-4-180HA05-HP230	30382808
7,30	8	91	53	43	36	SCD231-0730-2-4-180HA05-HP230	30382809
7,40	8	91	53	43	36	SCD231-0740-2-4-180HA05-HP230	30382810
7,50	8	91	53	43	36	SCD231-0750-2-4-180HA05-HP230	30382811
7,60	8	91	53	43	36	SCD231-0760-2-4-180HA05-HP230	30382812
7,80	8	91	53	43	36	SCD231-0780-2-4-180HA05-HP230	30382814
7,90	8	91	53	43	36	SCD231-0790-2-4-180HA05-HP230	30382815
8,00	8	91	53	43	36	SCD231-0800-2-4-180HA05-HP230	30382816
8,10	10	103	61	49	40	SCD231-0810-2-4-180HA05-HP230	30382817
8,20	10	103	61	49	40	SCD231-0820-2-4-180HA05-HP230	30382818
8,30	10	103	61	49	40	SCD231-0830-2-4-180HA05-HP230	30382819
8,40	10	103	61	49	40	SCD231-0840-2-4-180HA05-HP230	30382820
8,50	10	103	61	49	40	SCD231-0850-2-4-180HA05-HP230	30382821
8,60	10	103	61	49	40	SCD231-0860-2-4-180HA05-HP230	30382822
8,70	10	103	61	49	40	SCD231-0870-2-4-180HA05-HP230	30382823
8,80	10	103	61	49	40	SCD231-0880-2-4-180HA05-HP230	30382824
8,90	10	103	61	49	40	SCD231-0890-2-4-180HA05-HP230	30382825
9,00	10	103	61	49	40	SCD231-0900-2-4-180HA05-HP230	30382826
9,10	10	103	61	49	40	SCD231-0910-2-4-180HA05-HP230	30382827
9,20	10	103	61	49	40	SCD231-0920-2-4-180HA05-HP230	30382828
9,30	10	103	61	49	40	SCD231-0930-2-4-180HA05-HP230	30382829
9,40	10	103	61	49	40	SCD231-0940-2-4-180HA05-HP230	30382830
9,50	10	103	61	49	40	SCD231-0950-2-4-180HA05-HP230	30382831
9,60	10	103	61	49	40	SCD231-0960-2-4-180HA05-HP230	30382832
9,70	10	103	61	49	40	SCD231-0970-2-4-180HA05-HP230	30382833
9,80	10	103	61	49	40	SCD231-0980-2-4-180HA05-HP230	30382834
9,90	10	103	61	49	40	SCD231-0990-2-4-180HA05-HP230	30382835
10,00	10	103	61	49	40	SCD231-1000-2-4-180HA05-HP230	30382836
10,10	12	116	69	54	45	SCD231-1010-2-4-180HA05-HP230	30382838
10,20	12	116	69	54	45	SCD231-1020-2-4-180HA05-HP230	30382840
10,30	12	116	69	54	45	SCD231-1030-2-4-180HA05-HP230	30382841
10,40	12	116	69	54	45	SCD231-1040-2-4-180HA05-HP230	30382842
10,50	12	116	69	54	45	SCD231-1050-2-4-180HA05-HP230	30382843
10,60	12	116	69	54	45	SCD231-1060-2-4-180HA05-HP230	30382844
10,65	12	116	69	54	45	SCD231-1065-2-4-180HA05-HP230	31198519
10,80	12	116	69	54	45	SCD231-1080-2-4-180HA05-HP230	30382846
11,00	12	116	69	54	45	SCD231-1100-2-4-180HA05-HP230	30382848
11,20	12	116	69	54	45	SCD231-1120-2-4-180HA05-HP230	30382850
11,50	12	116	69	54	45	SCD231-1150-2-4-180HA05-HP230	30382853
11,60	12	116	69	54	45	SCD231-1160-2-4-180HA05-HP230	30382854
11,70	12	116	69	54	45	SCD231-1170-2-4-180HA05-HP230	30382855
11,80	12	116	69	54	45	SCD231-1180-2-4-180HA05-HP230	30382856
12,00	12	116	69	54	45	SCD231-1200-2-4-180HA05-HP230	30382858
12,50	14	122	75	58	45	SCD231-1250-2-4-180HA05-HP230	30382859
12,80	14	122	75	58	45	SCD231-1280-2-4-180HA05-HP230	30382860
13,00	14	122	75	58	45	SCD231-1300-2-4-180HA05-HP230	30382861
13,50	14	122	75	58	45	SCD231-1350-2-4-180HA05-HP230	30382862
13,80	14	122	75	58	45	SCD231-1380-2-4-180HA05-HP230	30382863
14,00	14	122	75	58	45	SCD231-1400-2-4-180HA05-HP230	30382864
14,50	16	131	81	61	48	SCD231-1450-2-4-180HA05-HP230	30382865

Ciąg dalszy na następnej stronie.

MEGA-180°-Drill | Wiertła spiralne z węgla spiekanego SCD231 (5xD), wewnętrzne doprowadzenie chłodziwa

Wymiary						Typ chwytu HA	
d ₁ m7	d ₂ h6	l ₁	l ₂	l ₃	l ₄	Specyfikacja	Nr materiałowy
14,80	16	131	81	61	48	SCD231-1480-2-4-180HA05-HP230	30382866
15,00	16	131	81	61	48	SCD231-1500-2-4-180HA05-HP230	30382867
15,50	16	131	81	61	48	SCD231-1550-2-4-180HA05-HP230	30382868
15,80	16	131	81	61	48	SCD231-1580-2-4-180HA05-HP230	30382869
16,00	16	131	81	61	48	SCD231-1600-2-4-180HA05-HP230	30382870
16,50	18	141	91	69	48	SCD231-1650-2-4-180HA05-HP230	30382871
17,00	18	141	91	69	48	SCD231-1700-2-4-180HA05-HP230	30382873
17,50	18	141	91	69	48	SCD231-1750-2-4-180HA05-HP230	30382874
17,80	18	141	91	69	48	SCD231-1780-2-4-180HA05-HP230	30382875
18,00	18	141	91	69	48	SCD231-1800-2-4-180HA05-HP230	30382876
18,50	20	151	99	75	50	SCD231-1850-2-4-180HA05-HP230	30382877
19,00	20	151	99	75	50	SCD231-1900-2-4-180HA05-HP230	30382879
19,80	20	151	99	75	50	SCD231-1980-2-4-180HA05-HP230	30382881
20,00	20	151	99	75	50	SCD231-2000-2-4-180HA05-HP230	30382882

Możliwość konfiguracji parametrów



Średnica:
możliwość wyboru średnicy w krokach
co 0,01 mm





Typ chwytu:
Typ chwytu: HB | HE

Specyfikacja:
SCD231-[średnica]-2-4-180[typ chwytu]05-HP230

Wymiary typoszeregu z możliwością konfiguracji parametrów

d ₁ min.	d ₁ max.	d ₂ h6	l ₁	l ₂	l ₃	l ₄
3,00	3,70	6	66	28	23	36
3,71	4,70	6	74	36	29	36
4,71	6,00	6	82	44	35	36
6,01	8,00	8	91	53	43	36
8,01	10,00	10	103	61	49	40
10,01	12,00	12	116	69	54	45
12,01	14,00	14	122	75	58	45
14,01	16,00	16	131	81	61	48
16,01	18,00	18	141	91	69	48
18,01	20,00	20	151	99	75	50

Przykład:

SCD231-0431-2-4-180HE05-HP230

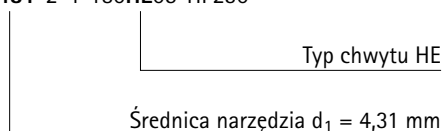

Wymiary podano w mm.

Zalecane parametry skrawania - patrz koniec rozdziału.

Wersje specjalne i inne powłoki wg zapytania ofertowego.

ECU-Drill-Steel

Wiertła spiralne z węgla spiekane
SCD361 (3xD), wewnętrzne doprowadzenie chłodziwa

Wersja:

Średnica wiertła: 3,00 - 20,00 mm
Tolerancja otworu: \geq IT 9
Materiał skrawający: HP132
Liczba ostrzy: 2
Kąt wierzchołkowy: 140°
Kąt spirali: 30°

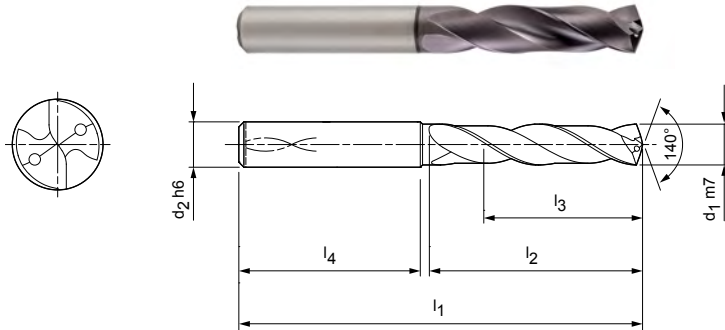

Magazynowa seria preferowana z typem chwytu HA

Wymiary						Typ chwytu HA	
d ₁ m7	d ₂ h6	l ₁	l ₂	l ₃	l ₄	Specyfikacja	Nr materiałowy
3,00	6	62	20	14	36	SCD361-0300-2-2-140HA03-HP132	30421364
3,10	6	62	20	14	36	SCD361-0310-2-2-140HA03-HP132	30421365
3,20	6	62	20	14	36	SCD361-0320-2-2-140HA03-HP132	30421366
3,30	6	62	20	14	36	SCD361-0330-2-2-140HA03-HP132	30421368
3,40	6	62	20	14	36	SCD361-0340-2-2-140HA03-HP132	30421369
3,50	6	62	20	14	36	SCD361-0350-2-2-140HA03-HP132	30421370
3,70*	6	62	20	14	36	SCD361-0370-2-2-140HA03-HP132	30421372
3,80	6	66	24	17	36	SCD361-0380-2-2-140HA03-HP132	30421373
3,90	6	66	24	17	36	SCD361-0390-2-2-140HA03-HP132	30421374
4,00	6	66	24	17	36	SCD361-0400-2-2-140HA03-HP132	30421375
4,10	6	66	24	17	36	SCD361-0410-2-2-140HA03-HP132	30421376
4,20	6	66	24	17	36	SCD361-0420-2-2-140HA03-HP132	30421377
4,30	6	66	24	17	36	SCD361-0430-2-2-140HA03-HP132	30421379
4,40	6	66	24	17	36	SCD361-0440-2-2-140HA03-HP132	30421380
4,50	6	66	24	17	36	SCD361-0450-2-2-140HA03-HP132	30421381
4,60	6	66	24	17	36	SCD361-0460-2-2-140HA03-HP132	30421382
4,65*	6	66	24	17	36	SCD361-0465-2-2-140HA03-HP132	30421383
4,70	6	66	24	17	36	SCD361-0470-2-2-140HA03-HP132	30421384
4,80	6	66	28	20	36	SCD361-0480-2-2-140HA03-HP132	30421385
4,90	6	66	28	20	36	SCD361-0490-2-2-140HA03-HP132	30421386
5,00	6	66	28	20	36	SCD361-0500-2-2-140HA03-HP132	30421388
5,10	6	66	28	20	36	SCD361-0510-2-2-140HA03-HP132	30421390
5,20	6	66	28	20	36	SCD361-0520-2-2-140HA03-HP132	30421391
5,30	6	66	28	20	36	SCD361-0530-2-2-140HA03-HP132	30421392
5,40	6	66	28	20	36	SCD361-0540-2-2-140HA03-HP132	30421393
5,50	6	66	28	20	36	SCD361-0550-2-2-140HA03-HP132	30421394
5,55*	6	66	28	20	36	SCD361-0555-2-2-140HA03-HP132	30421395
5,60	6	66	28	20	36	SCD361-0560-2-2-140HA03-HP132	30421396
5,80	6	66	28	20	36	SCD361-0580-2-2-140HA03-HP132	30421399
5,90	6	66	28	20	36	SCD361-0590-2-2-140HA03-HP132	30421400
6,00	6	66	28	20	36	SCD361-0600-2-2-140HA03-HP132	30421401
6,10	8	79	34	24	36	SCD361-0610-2-2-140HA03-HP132	30421402
6,20	8	79	34	24	36	SCD361-0620-2-2-140HA03-HP132	30421403
6,30	8	79	34	24	36	SCD361-0630-2-2-140HA03-HP132	30421404
6,40	8	79	34	24	36	SCD361-0640-2-2-140HA03-HP132	30421405

ECU-Drill-Steel | Wiertła spiralne z węgla spiekane SCD361 (3xD), wewnętrzne doprowadzenie chłodziwa

Wymiary						Typ chwytu HA	
d ₁ m7	d ₂ h6	l ₁	l ₂	l ₃	l ₄	Specyfikacja	Nr materiałowy
6,50	8	79	34	24	36	SCD361-0650-2-2-140HA03-HP132	30421406
6,60	8	79	34	24	36	SCD361-0660-2-2-140HA03-HP132	30421407
6,70	8	79	34	24	36	SCD361-0670-2-2-140HA03-HP132	30421408
6,80	8	79	34	24	36	SCD361-0680-2-2-140HA03-HP132	30421409
6,90	8	79	34	24	36	SCD361-0690-2-2-140HA03-HP132	30421410
7,00	8	79	34	24	36	SCD361-0700-2-2-140HA03-HP132	30421411
7,10	8	79	41	29	36	SCD361-0710-2-2-140HA03-HP132	30421412
7,20	8	79	41	29	36	SCD361-0720-2-2-140HA03-HP132	30421413
7,40	8	79	41	29	36	SCD361-0740-2-2-140HA03-HP132	30421415
7,45*	8	79	41	29	36	SCD361-0745-2-2-140HA03-HP132	30421416
7,50	8	79	41	29	36	SCD361-0750-2-2-140HA03-HP132	30421417
7,70	8	79	41	29	36	SCD361-0770-2-2-140HA03-HP132	30421420
7,80	8	79	41	29	36	SCD361-0780-2-2-140HA03-HP132	30421421
7,90	8	79	41	29	36	SCD361-0790-2-2-140HA03-HP132	30421422
8,00	8	79	41	29	36	SCD361-0800-2-2-140HA03-HP132	30421423
8,10	10	89	47	35	40	SCD361-0810-2-2-140HA03-HP132	30421424
8,20	10	89	47	35	40	SCD361-0820-2-2-140HA03-HP132	30421425
8,30	10	89	47	35	40	SCD361-0830-2-2-140HA03-HP132	30421426
8,40	10	89	47	35	40	SCD361-0840-2-2-140HA03-HP132	30421427
8,50	10	89	47	35	40	SCD361-0850-2-2-140HA03-HP132	30421428
8,60	10	89	47	35	40	SCD361-0860-2-2-140HA03-HP132	30421429
8,70	10	89	47	35	40	SCD361-0870-2-2-140HA03-HP132	30421430
8,80	10	89	47	35	40	SCD361-0880-2-2-140HA03-HP132	30421431
8,90	10	89	47	35	40	SCD361-0890-2-2-140HA03-HP132	30421432
9,00	10	89	47	35	40	SCD361-0900-2-2-140HA03-HP132	30421433
9,10	10	89	47	35	40	SCD361-0910-2-2-140HA03-HP132	30421434
9,20	10	89	47	35	40	SCD361-0920-2-2-140HA03-HP132	30421435
9,30*	10	89	47	35	40	SCD361-0930-2-2-140HA03-HP132	30421437
9,35	10	89	47	35	40	SCD361-0935-2-2-140HA03-HP132	30421438
9,40	10	89	47	35	40	SCD361-0940-2-2-140HA03-HP132	30421439
9,50	10	89	47	35	40	SCD361-0950-2-2-140HA03-HP132	30421440
9,60	10	89	47	35	40	SCD361-0960-2-2-140HA03-HP132	30421441
9,80	10	89	47	35	40	SCD361-0980-2-2-140HA03-HP132	30421443
9,90	10	89	47	35	40	SCD361-0990-2-2-140HA03-HP132	30421445
10,00	10	89	47	35	40	SCD361-1000-2-2-140HA03-HP132	30421446
10,10	12	102	55	40	45	SCD361-1010-2-2-140HA03-HP132	30421447
10,20	12	102	55	40	45	SCD361-1020-2-2-140HA03-HP132	30421448
10,30	12	102	55	40	45	SCD361-1030-2-2-140HA03-HP132	30421449
10,40	12	102	55	40	45	SCD361-1040-2-2-140HA03-HP132	30421450
10,50	12	102	55	40	45	SCD361-1050-2-2-140HA03-HP132	30421451
10,60	12	102	55	40	45	SCD361-1060-2-2-140HA03-HP132	30421453
10,70	12	102	55	40	45	SCD361-1070-2-2-140HA03-HP132	30421454
10,80	12	102	55	40	45	SCD361-1080-2-2-140HA03-HP132	30421456
10,90	12	102	55	40	45	SCD361-1090-2-2-140HA03-HP132	30421457
11,00	12	102	55	40	45	SCD361-1100-2-2-140HA03-HP132	30421458
11,10	12	102	55	40	45	SCD361-1110-2-2-140HA03-HP132	30421459
11,20*	12	102	55	40	45	SCD361-1120-2-2-140HA03-HP132	30421460
11,40	12	102	55	40	45	SCD361-1140-2-2-140HA03-HP132	30421463
11,50	12	102	55	40	45	SCD361-1150-2-2-140HA03-HP132	30421464
11,70	12	102	55	40	45	SCD361-1170-2-2-140HA03-HP132	30421466
11,80	12	102	55	40	45	SCD361-1180-2-2-140HA03-HP132	30421467
12,00	12	102	55	40	45	SCD361-1200-2-2-140HA03-HP132	30421469
12,25	14	107	60	43	45	SCD361-1225-2-2-140HA03-HP132	30421470
12,50	14	107	60	43	45	SCD361-1250-2-2-140HA03-HP132	30421471
12,70	14	107	60	43	45	SCD361-1270-2-2-140HA03-HP132	30421472
12,80	14	107	60	43	45	SCD361-1280-2-2-140HA03-HP132	30421473
12,90	14	107	60	43	45	SCD361-1290-2-2-140HA03-HP132	30421474

ECU-Drill-Steel | Wiertła spiralne z węgla spiekane SCD361 (3xD), wewnętrzne doprowadzenie chłodziwa

Wymiary						Typ chwytu HA	
d ₁ m7	d ₂ h6	l ₁	l ₂	l ₃	l ₄	Specyfikacja	Nr materiałowy
13,00	14	107	60	43	45	SCD361-1300-2-2-140HA03-HP132	30421475
13,10	14	107	60	43	45	SCD361-1310-2-2-140HA03-HP132	30421476
13,20	14	107	60	43	45	SCD361-1320-2-2-140HA03-HP132	30421477
13,50	14	107	60	43	45	SCD361-1350-2-2-140HA03-HP132	30421479
13,80	14	107	60	43	45	SCD361-1380-2-2-140HA03-HP132	30421481
14,00	14	107	60	43	45	SCD361-1400-2-2-140HA03-HP132	30421482
14,20	16	115	65	45	48	SCD361-1420-2-2-140HA03-HP132	30421483
14,50	16	115	65	45	48	SCD361-1450-2-2-140HA03-HP132	30421484
14,80	16	115	65	45	48	SCD361-1480-2-2-140HA03-HP132	30421487
15,00	16	115	65	45	48	SCD361-1500-2-2-140HA03-HP132	30421488
15,10	16	115	65	45	48	SCD361-1510-2-2-140HA03-HP132	30421489
15,25	16	115	65	45	48	SCD361-1525-2-2-140HA03-HP132	30421490
15,30	16	115	65	45	48	SCD361-1530-2-2-140HA03-HP132	30421491
15,50	16	115	65	45	48	SCD361-1550-2-2-140HA03-HP132	30421493
15,80	16	115	65	45	48	SCD361-1580-2-2-140HA03-HP132	30421496
16,00	16	115	65	45	48	SCD361-1600-2-2-140HA03-HP132	30421497
16,50	18	123	73	51	48	SCD361-1650-2-2-140HA03-HP132	30421498
16,80	18	123	73	51	48	SCD361-1680-2-2-140HA03-HP132	30421499
17,00	18	123	73	51	48	SCD361-1700-2-2-140HA03-HP132	30421501
17,50	18	123	73	51	48	SCD361-1750-2-2-140HA03-HP132	30421502
17,80	18	123	73	51	48	SCD361-1780-2-2-140HA03-HP132	30421504
18,00	18	123	73	51	48	SCD361-1800-2-2-140HA03-HP132	30421505
18,50	20	131	79	55	50	SCD361-1850-2-2-140HA03-HP132	30421506
19,00	20	131	79	55	50	SCD361-1900-2-2-140HA03-HP132	30421509
19,80	20	131	79	55	50	SCD361-1980-2-2-140HA03-HP132	30421512
20,00	20	131	79	55	50	SCD361-2000-2-2-140HA03-HP132	30421513

Możliwość konfiguracji parametrów



Typ chwytu:
Typ chwytu: HB | HE



Specyfikacja:
SCD361-0430-2-2-140[typ chwytu]03-HP132

Przykład:

SCD361-0430-2-2-140HE03-HP132

 Typ chwytu HE

Wymiary podano w mm.

*Nadaje się w szczególności do wiercenia otworów pod gwinty wykonywanych gniotownikami.

Zalecane parametry skrawania - patrz koniec rozdziału.

Wersje specjalne i inne powłoki wg zapytania ofertowego.

ECU-Drill-Steel

Wiertła spiralne z węgla spiekane
SCD360 (3xD), zewnętrzne doprowadzenie chłodziwa

Wersja:

Średnica wiertła: 3,00 - 20,00 mm

Tolerancja otworu: \geq IT 9

Materiał skrawający: HP132

Liczba ostrzy: 2

Kąt wierzchołkowy: 140°

Kąt spirali: 30°

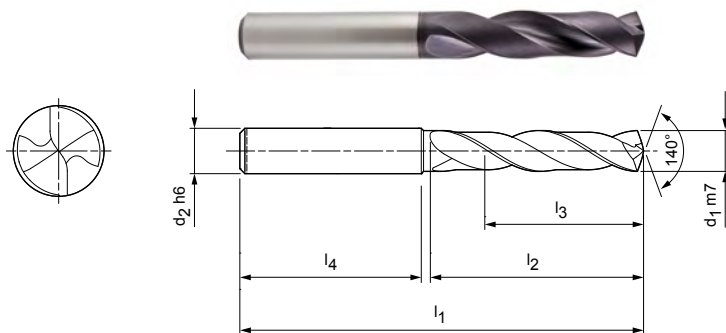

Magazynowa seria preferowana z typem chwytu HA

Wymiary						Typ chwytu HA	
d ₁ m7	d ₂ h6	l ₁	l ₂	l ₃	l ₄	Specyfikacja	Nr materiałowy
3,00	6	62	20	14	36	SCD360-0300-2-2-140HA03-HP132	30421215
3,10	6	62	20	14	36	SCD360-0310-2-2-140HA03-HP132	30421216
3,20	6	62	20	14	36	SCD360-0320-2-2-140HA03-HP132	30421217
3,30	6	62	20	14	36	SCD360-0330-2-2-140HA03-HP132	30421218
3,40	6	62	20	14	36	SCD360-0340-2-2-140HA03-HP132	30421219
3,50	6	62	20	14	36	SCD360-0350-2-2-140HA03-HP132	30421220
3,60	6	62	20	14	36	SCD360-0360-2-2-140HA03-HP132	30421221
3,70*	6	62	20	14	36	SCD360-0370-2-2-140HA03-HP132	30421222
3,80	6	66	24	17	36	SCD360-0380-2-2-140HA03-HP132	30421223
3,90	6	66	24	17	36	SCD360-0390-2-2-140HA03-HP132	30421224
4,00	6	66	24	17	36	SCD360-0400-2-2-140HA03-HP132	30421225
4,02	6	66	24	17	36	SCD360-0402-2-2-140HA03-HP132	30421226
4,10	6	66	24	17	36	SCD360-0410-2-2-140HA03-HP132	30421227
4,20	6	66	24	17	36	SCD360-0420-2-2-140HA03-HP132	30421228
4,30	6	66	24	17	36	SCD360-0430-2-2-140HA03-HP132	30421229
4,40	6	66	24	17	36	SCD360-0440-2-2-140HA03-HP132	30421230
4,50	6	66	24	17	36	SCD360-0450-2-2-140HA03-HP132	30421231
4,60	6	66	24	17	36	SCD360-0460-2-2-140HA03-HP132	30421232
4,65*	6	66	24	17	36	SCD360-0465-2-2-140HA03-HP132	30421233
4,70	6	66	24	17	36	SCD360-0470-2-2-140HA03-HP132	30421234
4,80	6	66	28	20	36	SCD360-0480-2-2-140HA03-HP132	30421235
4,90	6	66	28	20	36	SCD360-0490-2-2-140HA03-HP132	30421236
5,00	6	66	28	20	36	SCD360-0500-2-2-140HA03-HP132	30421237
5,10	6	66	28	20	36	SCD360-0510-2-2-140HA03-HP132	30421238
5,20	6	66	28	20	36	SCD360-0520-2-2-140HA03-HP132	30421240
5,30	6	66	28	20	36	SCD360-0530-2-2-140HA03-HP132	30421241
5,40	6	66	28	20	36	SCD360-0540-2-2-140HA03-HP132	30421242
5,50	6	66	28	20	36	SCD360-0550-2-2-140HA03-HP132	30421243
5,55*	6	66	28	20	36	SCD360-0555-2-2-140HA03-HP132	30421244
5,60	6	66	28	20	36	SCD360-0560-2-2-140HA03-HP132	30421245
5,70	6	66	28	20	36	SCD360-0570-2-2-140HA03-HP132	30421246
5,80	6	66	28	20	36	SCD360-0580-2-2-140HA03-HP132	30421247
5,90	6	66	28	20	36	SCD360-0590-2-2-140HA03-HP132	30421248
6,00	6	66	28	20	36	SCD360-0600-2-2-140HA03-HP132	30421249
6,10	8	79	34	24	36	SCD360-0610-2-2-140HA03-HP132	30421250

ECU-Drill-Steel | Wiertła spiralne z węgla spiekane SCD360 (3xD), zewnętrzne doprowadzenie chłodziwa

Wymiary						Typ chwytu HA	
d ₁ m7	d ₂ h6	l ₁	l ₂	l ₃	l ₄	Specyfikacja	Nr materiałowy
6,20	8	79	34	24	36	SCD360-0620-2-2-140HA03-HP132	30421251
6,30	8	79	34	24	36	SCD360-0630-2-2-140HA03-HP132	30421252
6,40	8	79	34	24	36	SCD360-0640-2-2-140HA03-HP132	30421253
6,50	8	79	34	24	36	SCD360-0650-2-2-140HA03-HP132	30421254
6,60	8	79	34	24	36	SCD360-0660-2-2-140HA03-HP132	30421255
6,70	8	79	34	24	36	SCD360-0670-2-2-140HA03-HP132	30421256
6,80	8	79	34	24	36	SCD360-0680-2-2-140HA03-HP132	30421257
6,90	8	79	34	24	36	SCD360-0690-2-2-140HA03-HP132	30421258
7,00	8	79	34	24	36	SCD360-0700-2-2-140HA03-HP132	30421259
7,10	8	79	41	29	36	SCD360-0710-2-2-140HA03-HP132	30421260
7,20	8	79	41	29	36	SCD360-0720-2-2-140HA03-HP132	30421261
7,30	8	79	41	29	36	SCD360-0730-2-2-140HA03-HP132	30421262
7,40	8	79	41	29	36	SCD360-0740-2-2-140HA03-HP132	30421263
7,50	8	79	41	29	36	SCD360-0750-2-2-140HA03-HP132	30421264
7,60	8	79	41	29	36	SCD360-0760-2-2-140HA03-HP132	30421266
7,70	8	79	41	29	36	SCD360-0770-2-2-140HA03-HP132	30421267
7,80	8	79	41	29	36	SCD360-0780-2-2-140HA03-HP132	30421268
7,90	8	79	41	29	36	SCD360-0790-2-2-140HA03-HP132	30421269
8,00	8	79	41	29	36	SCD360-0800-2-2-140HA03-HP132	30421270
8,10	10	89	47	35	40	SCD360-0810-2-2-140HA03-HP132	30421271
8,20	10	89	47	35	40	SCD360-0820-2-2-140HA03-HP132	30421272
8,30	10	89	47	35	40	SCD360-0830-2-2-140HA03-HP132	30421273
8,40	10	89	47	35	40	SCD360-0840-2-2-140HA03-HP132	30421274
8,50	10	89	47	35	40	SCD360-0850-2-2-140HA03-HP132	30421275
8,60	10	89	47	35	40	SCD360-0860-2-2-140HA03-HP132	30421276
8,70	10	89	47	35	40	SCD360-0870-2-2-140HA03-HP132	30421277
8,80	10	89	47	35	40	SCD360-0880-2-2-140HA03-HP132	30421278
8,90	10	89	47	35	40	SCD360-0890-2-2-140HA03-HP132	30421279
9,00	10	89	47	35	40	SCD360-0900-2-2-140HA03-HP132	30421280
9,10	10	89	47	35	40	SCD360-0910-2-2-140HA03-HP132	30421281
9,20	10	89	47	35	40	SCD360-0920-2-2-140HA03-HP132	30421282
9,30*	10	89	47	35	40	SCD360-0930-2-2-140HA03-HP132	30421284
9,40	10	89	47	35	40	SCD360-0940-2-2-140HA03-HP132	30421285
9,50	10	89	47	35	40	SCD360-0950-2-2-140HA03-HP132	30421286
9,60	10	89	47	35	40	SCD360-0960-2-2-140HA03-HP132	30421287
9,70	10	89	47	35	40	SCD360-0970-2-2-140HA03-HP132	30421288
9,80	10	89	47	35	40	SCD360-0980-2-2-140HA03-HP132	30421289
9,90	10	89	47	35	40	SCD360-0990-2-2-140HA03-HP132	30421290
10,00	10	89	47	35	40	SCD360-1000-2-2-140HA03-HP132	30421291
10,10	12	102	55	40	45	SCD360-1010-2-2-140HA03-HP132	30421292
10,20	12	102	55	40	45	SCD360-1020-2-2-140HA03-HP132	30421293
10,30	12	102	55	40	45	SCD360-1030-2-2-140HA03-HP132	30421294
10,40	12	102	55	40	45	SCD360-1040-2-2-140HA03-HP132	30421295
10,50	12	102	55	40	45	SCD360-1050-2-2-140HA03-HP132	30421296
10,60	12	102	55	40	45	SCD360-1060-2-2-140HA03-HP132	30421297
10,70	12	102	55	40	45	SCD360-1070-2-2-140HA03-HP132	30421298
10,80	12	102	55	40	45	SCD360-1080-2-2-140HA03-HP132	30421300
10,90	12	102	55	40	45	SCD360-1090-2-2-140HA03-HP132	30421301
11,00	12	102	55	40	45	SCD360-1100-2-2-140HA03-HP132	30421302
11,10	12	102	55	40	45	SCD360-1110-2-2-140HA03-HP132	30421303
11,20*	12	102	55	40	45	SCD360-1120-2-2-140HA03-HP132	30421304
11,30	12	102	55	40	45	SCD360-1130-2-2-140HA03-HP132	30421305
11,40	12	102	55	40	45	SCD360-1140-2-2-140HA03-HP132	30421306
11,50	12	102	55	40	45	SCD360-1150-2-2-140HA03-HP132	30421307
11,60	12	102	55	40	45	SCD360-1160-2-2-140HA03-HP132	30421308
11,70	12	102	55	40	45	SCD360-1170-2-2-140HA03-HP132	30421309
11,80	12	102	55	40	45	SCD360-1180-2-2-140HA03-HP132	30421310

Ciąg dalszy na następnej stronie.

ECU-Drill-Steel | Wiertła spiralne z węgla spiekane SCD360 (3xD), zewnętrzne doprowadzenie chłodziwa

Wymiary						Typ chwytu HA	
d ₁ m7	d ₂ h6	l ₁	l ₂	l ₃	l ₄	Specyfikacja	Nr materiałowy
11,90	12	102	55	40	45	SCD360-1190-2-2-140HA03-HP132	30421312
12,00	12	102	55	40	45	SCD360-1200-2-2-140HA03-HP132	30421313
12,20	14	107	60	43	45	SCD360-1220-2-2-140HA03-HP132	30569112
12,25	14	107	60	43	45	SCD360-1225-2-2-140HA03-HP132	30421314
12,50	14	107	60	43	45	SCD360-1250-2-2-140HA03-HP132	30421316
12,70	14	107	60	43	45	SCD360-1270-2-2-140HA03-HP132	30421317
12,80	14	107	60	43	45	SCD360-1280-2-2-140HA03-HP132	30421318
13,00	14	107	60	43	45	SCD360-1300-2-2-140HA03-HP132	30421320
13,30	14	107	60	43	45	SCD360-1330-2-2-140HA03-HP132	30421323
13,50	14	107	60	43	45	SCD360-1350-2-2-140HA03-HP132	30421324
13,70	14	107	60	43	45	SCD360-1370-2-2-140HA03-HP132	30421325
13,80	14	107	60	43	45	SCD360-1380-2-2-140HA03-HP132	30421326
14,00	14	107	60	43	45	SCD360-1400-2-2-140HA03-HP132	30421327
14,20	16	115	65	45	48	SCD360-1420-2-2-140HA03-HP132	30421328
14,50	16	115	65	45	48	SCD360-1450-2-2-140HA03-HP132	30421330
14,70	16	115	65	45	48	SCD360-1470-2-2-140HA03-HP132	30421331
15,00	16	115	65	45	48	SCD360-1500-2-2-140HA03-HP132	30421333
15,25	16	115	65	45	48	SCD360-1525-2-2-140HA03-HP132	30421335
15,30	16	115	65	45	48	SCD360-1530-2-2-140HA03-HP132	30421336
15,50	16	115	65	45	48	SCD360-1550-2-2-140HA03-HP132	30421337
15,80	16	115	65	45	48	SCD360-1580-2-2-140HA03-HP132	30421339
16,00	16	115	65	45	48	SCD360-1600-2-2-140HA03-HP132	30421340
16,50	18	123	73	51	48	SCD360-1650-2-2-140HA03-HP132	30421341
16,80	18	123	73	51	48	SCD360-1680-2-2-140HA03-HP132	30421342
17,00	18	123	73	51	48	SCD360-1700-2-2-140HA03-HP132	30421343
17,50	18	123	73	51	48	SCD360-1750-2-2-140HA03-HP132	30421344
17,80	18	123	73	51	48	SCD360-1780-2-2-140HA03-HP132	30421345
18,00	18	123	73	51	48	SCD360-1800-2-2-140HA03-HP132	30421346
18,50	20	131	79	55	50	SCD360-1850-2-2-140HA03-HP132	30421347
19,00	20	131	79	55	50	SCD360-1900-2-2-140HA03-HP132	30421349
19,50	20	131	79	55	50	SCD360-1950-2-2-140HA03-HP132	30421350
19,80	20	131	79	55	50	SCD360-1980-2-2-140HA03-HP132	30421351
20,00	20	131	79	55	50	SCD360-2000-2-2-140HA03-HP132	30421352

Możliwość konfiguracji parametrów



Typ chwytu:
Typ chwytu: HB | HE



Specyfikacja:
SCD360-0430-2-2-140[typ chwytu]05-HP132

Przykład:

SCD360-0430-2-2-140HE05-HP132

Typ chwytu HE

Wymiary podano w mm.

*Nadaje się w szczególności do wiercenia otworów pod gwinty wykonywanych gniotownikami.

Zalecane parametry skrawania – patrz koniec rozdziału.

Wersje specjalne i inne powłoki wg zapytania ofertowego.

ECU-Drill-Steel

Wiertła spiralne z węgla spiekanego
SCD361 (5xD), wewnętrzne doprowadzenie chłodziwa

Wersja:

Średnica wiertła: 3,00 - 20,00 mm

Tolerancja otworu: \geq IT 9

Materiał skrawający: HP132

Liczba ostrzy: 2

Kąt wierzchołkowy: 140°

Kąt spirali: 30°

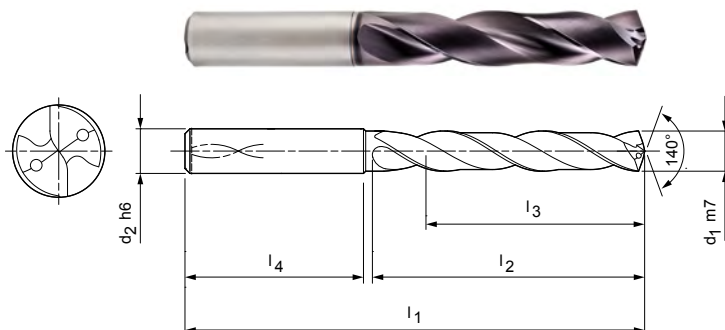

Magazynowa seria preferowana z typem chwytu HA

Wymiary						Typ chwytu HA	
d ₁ m7	d ₂ h6	l ₁	l ₂	l ₃	l ₄	Specyfikacja	Nr materiałowy
3,00	6	66	28	23	36	SCD361-0300-2-2-140HA05-HP132	30421524
3,10	6	66	28	23	36	SCD361-0310-2-2-140HA05-HP132	30421525
3,20	6	66	28	23	36	SCD361-0320-2-2-140HA05-HP132	30421526
3,30	6	66	28	23	36	SCD361-0330-2-2-140HA05-HP132	30421528
3,40	6	66	28	23	36	SCD361-0340-2-2-140HA05-HP132	30421529
3,50	6	66	28	23	36	SCD361-0350-2-2-140HA05-HP132	30421530
3,60	6	66	28	23	36	SCD361-0360-2-2-140HA05-HP132	30421531
3,70*	6	66	28	23	36	SCD361-0370-2-2-140HA05-HP132	30421532
3,80	6	74	36	29	36	SCD361-0380-2-2-140HA05-HP132	30421533
3,90	6	74	36	29	36	SCD361-0390-2-2-140HA05-HP132	30421534
4,00	6	74	36	29	36	SCD361-0400-2-2-140HA05-HP132	30421535
4,10	6	74	36	29	36	SCD361-0410-2-2-140HA05-HP132	30421536
4,20	6	74	36	29	36	SCD361-0420-2-2-140HA05-HP132	30421537
4,30	6	74	36	29	36	SCD361-0430-2-2-140HA05-HP132	30421539
4,40	6	74	36	29	36	SCD361-0440-2-2-140HA05-HP132	30421540
4,50	6	74	36	29	36	SCD361-0450-2-2-140HA05-HP132	30421541
4,60	6	74	36	29	36	SCD361-0460-2-2-140HA05-HP132	30421542
4,65*	6	74	36	29	36	SCD361-0465-2-2-140HA05-HP132	30421543
4,70	6	74	36	29	36	SCD361-0470-2-2-140HA05-HP132	30421544
4,80	6	82	44	35	36	SCD361-0480-2-2-140HA05-HP132	30421545
4,90	6	82	44	35	36	SCD361-0490-2-2-140HA05-HP132	30421546
5,00	6	82	44	35	36	SCD361-0500-2-2-140HA05-HP132	30421548
5,10	6	82	44	35	36	SCD361-0510-2-2-140HA05-HP132	30421550
5,20	6	82	44	35	36	SCD361-0520-2-2-140HA05-HP132	30421551
5,30	6	82	44	35	36	SCD361-0530-2-2-140HA05-HP132	30421552
5,40	6	82	44	35	36	SCD361-0540-2-2-140HA05-HP132	30421553
5,50	6	82	44	35	36	SCD361-0550-2-2-140HA05-HP132	30421554
5,55*	6	82	44	35	36	SCD361-0555-2-2-140HA05-HP132	30421555
5,60	6	82	44	35	36	SCD361-0560-2-2-140HA05-HP132	30421556
5,70	6	82	44	35	36	SCD361-0570-2-2-140HA05-HP132	30421557
5,80	6	82	44	35	36	SCD361-0580-2-2-140HA05-HP132	30421559
5,90	6	82	44	35	36	SCD361-0590-2-2-140HA05-HP132	30421560
6,00	6	82	44	35	36	SCD361-0600-2-2-140HA05-HP132	30421561
6,10	8	91	53	43	36	SCD361-0610-2-2-140HA05-HP132	30421562
6,20	8	91	53	43	36	SCD361-0620-2-2-140HA05-HP132	30421563

ECU-Drill-Steel | Wiertło spiralne z węgla spiekane SCD361 (5xD), wewnętrzne doprowadzenie chłodziwa

Wymiary						Typ chwytu HA	
d ₁ m7	d ₂ h6	l ₁	l ₂	l ₃	l ₄	Specyfikacja	Nr materiałowy
6,30	8	91	53	43	36	SCD361-0630-2-2-140HA05-HP132	30421564
6,40	8	91	53	43	36	SCD361-0640-2-2-140HA05-HP132	30421565
6,50	8	91	53	43	36	SCD361-0650-2-2-140HA05-HP132	30421566
6,60	8	91	53	43	36	SCD361-0660-2-2-140HA05-HP132	30421567
6,70	8	91	53	43	36	SCD361-0670-2-2-140HA05-HP132	30421568
6,80	8	91	53	43	36	SCD361-0680-2-2-140HA05-HP132	30421569
6,90	8	91	53	43	36	SCD361-0690-2-2-140HA05-HP132	30421570
7,00	8	91	53	43	36	SCD361-0700-2-2-140HA05-HP132	30421571
7,10	8	91	53	43	36	SCD361-0710-2-2-140HA05-HP132	30421572
7,20	8	91	53	43	36	SCD361-0720-2-2-140HA05-HP132	30421573
7,30	8	91	53	43	36	SCD361-0730-2-2-140HA05-HP132	30421574
7,40	8	91	53	43	36	SCD361-0740-2-2-140HA05-HP132	30421575
7,45*	8	91	53	43	36	SCD361-0745-2-2-140HA05-HP132	30421576
7,50	8	91	53	43	36	SCD361-0750-2-2-140HA05-HP132	30421577
7,60	8	91	53	43	36	SCD361-0760-2-2-140HA05-HP132	30421579
7,70	8	91	53	43	36	SCD361-0770-2-2-140HA05-HP132	30421580
7,80	8	91	53	43	36	SCD361-0780-2-2-140HA05-HP132	30421581
7,90	8	91	53	43	36	SCD361-0790-2-2-140HA05-HP132	30421582
8,00	8	91	53	43	36	SCD361-0800-2-2-140HA05-HP132	30421583
8,10	10	103	61	49	40	SCD361-0810-2-2-140HA05-HP132	30421584
8,20	10	103	61	49	40	SCD361-0820-2-2-140HA05-HP132	30421585
8,30	10	103	61	49	40	SCD361-0830-2-2-140HA05-HP132	30421586
8,40	10	103	61	49	40	SCD361-0840-2-2-140HA05-HP132	30421587
8,50	10	103	61	49	40	SCD361-0850-2-2-140HA05-HP132	30421588
8,60	10	103	61	49	40	SCD361-0860-2-2-140HA05-HP132	30421589
8,70	10	103	61	49	40	SCD361-0870-2-2-140HA05-HP132	30421590
8,80	10	103	61	49	40	SCD361-0880-2-2-140HA05-HP132	30421591
8,90	10	103	61	49	40	SCD361-0890-2-2-140HA05-HP132	30421592
9,00	10	103	61	49	40	SCD361-0900-2-2-140HA05-HP132	30421593
9,10	10	103	61	49	40	SCD361-0910-2-2-140HA05-HP132	30421594
9,20	10	103	61	49	40	SCD361-0920-2-2-140HA05-HP132	30421595
9,30*	10	103	61	49	40	SCD361-0930-2-2-140HA05-HP132	30421597
9,35	10	103	61	49	40	SCD361-0935-2-2-140HA05-HP132	30421598
9,40	10	103	61	49	40	SCD361-0940-2-2-140HA05-HP132	30421599
9,50	10	103	61	49	40	SCD361-0950-2-2-140HA05-HP132	30421600
9,60	10	103	61	49	40	SCD361-0960-2-2-140HA05-HP132	30421601
9,70	10	103	61	49	40	SCD361-0970-2-2-140HA05-HP132	30421602
9,80	10	103	61	49	40	SCD361-0980-2-2-140HA05-HP132	30421603
9,90	10	103	61	49	40	SCD361-0990-2-2-140HA05-HP132	30421604
10,00	10	103	61	49	40	SCD361-1000-2-2-140HA05-HP132	30421605
10,10	12	118	71	56	45	SCD361-1010-2-2-140HA05-HP132	30421606
10,20	12	118	71	56	45	SCD361-1020-2-2-140HA05-HP132	30421607
10,30	12	118	71	56	45	SCD361-1030-2-2-140HA05-HP132	30421608
10,40	12	118	71	56	45	SCD361-1040-2-2-140HA05-HP132	30421609
10,50	12	118	71	56	45	SCD361-1050-2-2-140HA05-HP132	30421610
10,60	12	118	71	56	45	SCD361-1060-2-2-140HA05-HP132	30421612
10,70	12	118	71	56	45	SCD361-1070-2-2-140HA05-HP132	30421613
10,80	12	118	71	56	45	SCD361-1080-2-2-140HA05-HP132	30421615
10,90	12	118	71	56	45	SCD361-1090-2-2-140HA05-HP132	30421616
11,00	12	118	71	56	45	SCD361-1100-2-2-140HA05-HP132	30421617
11,10	12	118	71	56	45	SCD361-1110-2-2-140HA05-HP132	30421618
11,20*	12	118	71	56	45	SCD361-1120-2-2-140HA05-HP132	30421619
11,25	12	118	71	56	45	SCD361-1125-2-2-140HA05-HP132	30421620
11,30	12	118	71	56	45	SCD361-1130-2-2-140HA05-HP132	30421621
11,40	12	118	71	56	45	SCD361-1140-2-2-140HA05-HP132	30421622
11,50	12	118	71	56	45	SCD361-1150-2-2-140HA05-HP132	30421623
11,60	12	118	71	56	45	SCD361-1160-2-2-140HA05-HP132	30421624

ECU-Drill-Steel | Wiertło spiralne z węgla spiekane SCD361 (5xD), wewnętrzne doprowadzenie chłodziwa

Wymiary						Typ chwytu HA	
d ₁ m7	d ₂ h6	l ₁	l ₂	l ₃	l ₄	Specyfikacja	Nr materiałowy
11,70	12	118	71	56	45	SCD361-1170-2-2-140HA05-HP132	30421625
11,80	12	118	71	56	45	SCD361-1180-2-2-140HA05-HP132	30421626
11,90	12	118	71	56	45	SCD361-1190-2-2-140HA05-HP132	30421628
12,00	12	118	71	56	45	SCD361-1200-2-2-140HA05-HP132	30421629
12,20	14	124	77	60	45	SCD361-1220-2-2-140HA05-HP132	30569175
12,25	14	124	77	60	45	SCD361-1225-2-2-140HA05-HP132	30421630
12,50	14	124	77	60	45	SCD361-1250-2-2-140HA05-HP132	30421632
12,70	14	124	77	60	45	SCD361-1270-2-2-140HA05-HP132	30421633
12,80	14	124	77	60	45	SCD361-1280-2-2-140HA05-HP132	30421634
12,90	14	124	77	60	45	SCD361-1290-2-2-140HA05-HP132	30421635
13,00	14	124	77	60	45	SCD361-1300-2-2-140HA05-HP132	30421636
13,10	14	124	77	60	45	SCD361-1310-2-2-140HA05-HP132	30421637
13,20	14	124	77	60	45	SCD361-1320-2-2-140HA05-HP132	30421638
13,50	14	124	77	60	45	SCD361-1350-2-2-140HA05-HP132	30421640
13,70	14	124	77	60	45	SCD361-1370-2-2-140HA05-HP132	30421641
13,80	14	124	77	60	45	SCD361-1380-2-2-140HA05-HP132	30421642
14,00	14	124	77	60	45	SCD361-1400-2-2-140HA05-HP132	30421643
14,20	16	133	83	63	48	SCD361-1420-2-2-140HA05-HP132	30421644
14,50	16	133	83	63	48	SCD361-1450-2-2-140HA05-HP132	30421645
14,70	16	133	83	63	48	SCD361-1470-2-2-140HA05-HP132	30421646
14,80	16	133	83	63	48	SCD361-1480-2-2-140HA05-HP132	30421647
15,00	16	133	83	63	48	SCD361-1500-2-2-140HA05-HP132	30421648
15,10	16	133	83	63	48	SCD361-1510-2-2-140HA05-HP132	30421649
15,25	16	133	83	63	48	SCD361-1525-2-2-140HA05-HP132	30421650
15,30	16	133	83	63	48	SCD361-1530-2-2-140HA05-HP132	30421651
15,50	16	133	83	63	48	SCD361-1550-2-2-140HA05-HP132	30421652
15,70	16	133	83	63	48	SCD361-1570-2-2-140HA05-HP132	30421654
15,80	16	133	83	63	48	SCD361-1580-2-2-140HA05-HP132	30421655
16,00	16	133	83	63	48	SCD361-1600-2-2-140HA05-HP132	30421656
16,50	18	143	93	71	48	SCD361-1650-2-2-140HA05-HP132	30421657
16,80	18	143	93	71	48	SCD361-1680-2-2-140HA05-HP132	30421658
17,00	18	143	93	71	48	SCD361-1700-2-2-140HA05-HP132	30421660
17,50	18	143	93	71	48	SCD361-1750-2-2-140HA05-HP132	30421661
17,80	18	143	93	71	48	SCD361-1780-2-2-140HA05-HP132	30421663
18,00	18	143	93	71	48	SCD361-1800-2-2-140HA05-HP132	30421664
18,50	20	153	101	77	50	SCD361-1850-2-2-140HA05-HP132	30421665
18,80	20	153	101	77	50	SCD361-1880-2-2-140HA05-HP132	30421666
19,00	20	153	101	77	50	SCD361-1900-2-2-140HA05-HP132	30421668
19,50	20	153	101	77	50	SCD361-1950-2-2-140HA05-HP132	30421669
19,80	20	153	101	77	50	SCD361-1980-2-2-140HA05-HP132	30421671
20,00	20	153	101	77	50	SCD361-2000-2-2-140HA05-HP132	30421672

Ciąg dalszy na następnej stronie.

ECU-Drill-Steel | Wiertło spiralne z węgla spiekanego SCD361 (5xD), wewnętrzne doprowadzenie chłodziwa

Możliwość konfiguracji parametrów



Typ chwytu:
Typ chwytu: HB | HE

**Specyfikacja:**

SCD361-0430-2-2-140[typ chwytu]05-HP132

Przykład:

SCD361-0430-2-2-140HE05-HP132

Typ chwytu HE

Wymiary podano w mm.

*Nadaje się w szczególności do wiercenia otworów pod gwinty wykonywanych gniotownikami.

Zalecane parametry skrawania - patrz koniec rozdziału.

Wersje specjalne i inne powłoki wg zapytania ofertowego.

ECU-Drill-Steel

Wiertła spiralne z węgla spiekanego
SCD360 (5xD), zewnętrzne doprowadzenie chłodziwa

Wersja:

Średnica wiertła: 3,00 - 20,00 mm

Tolerancja otworu: \geq IT 9

Materiał skrawający: HP132

Liczba ostrzy: 2

Kąt wierzchołkowy: 140°

Kąt spirali: 30°

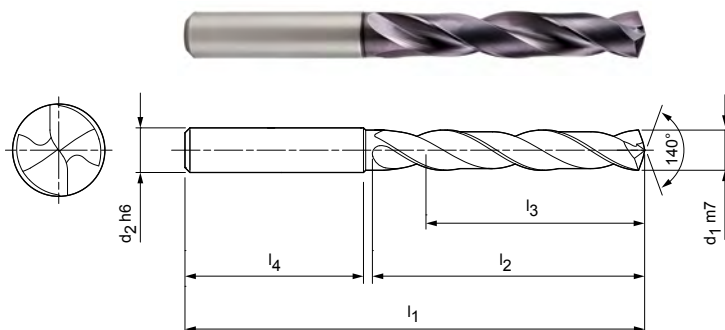

Magazynowa seria preferowana z typem chwytu HA

Wymiary						Typ chwytu HA	
d ₁ m7	d ₂ h6	l ₁	l ₂	l ₃	l ₄	Specyfikacja	Nr materiałowy
3,00	6	66	28	23	36	SCD360-0300-2-2-140HA05-HP132	30568692
3,10	6	66	28	23	36	SCD360-0310-2-2-140HA05-HP132	30568693
3,20	6	66	28	23	36	SCD360-0320-2-2-140HA05-HP132	30568694
3,30	6	66	28	23	36	SCD360-0330-2-2-140HA05-HP132	30568695
3,40	6	66	28	23	36	SCD360-0340-2-2-140HA05-HP132	30568696
3,50	6	66	28	23	36	SCD360-0350-2-2-140HA05-HP132	30568697
3,60	6	66	28	23	36	SCD360-0360-2-2-140HA05-HP132	30568698
3,70*	6	66	28	23	36	SCD360-0370-2-2-140HA05-HP132	30568699
3,80	6	74	36	29	36	SCD360-0380-2-2-140HA05-HP132	30568700
3,90	6	74	36	29	36	SCD360-0390-2-2-140HA05-HP132	30568701
4,00	6	74	36	29	36	SCD360-0400-2-2-140HA05-HP132	30568702
4,10	6	74	36	29	36	SCD360-0410-2-2-140HA05-HP132	30568703
4,20	6	74	36	29	36	SCD360-0420-2-2-140HA05-HP132	30568704
4,30	6	74	36	29	36	SCD360-0430-2-2-140HA05-HP132	30568705
4,40	6	74	36	29	36	SCD360-0440-2-2-140HA05-HP132	30568706
4,50	6	74	36	29	36	SCD360-0450-2-2-140HA05-HP132	30568707
4,60	6	74	36	29	36	SCD360-0460-2-2-140HA05-HP132	30568708
4,65*	6	74	36	29	36	SCD360-0465-2-2-140HA05-HP132	30568709
4,70	6	74	36	29	36	SCD360-0470-2-2-140HA05-HP132	30568710
4,80	6	82	44	35	36	SCD360-0480-2-2-140HA05-HP132	30568711
4,90	6	82	44	35	36	SCD360-0490-2-2-140HA05-HP132	30568712
5,00	6	82	44	35	36	SCD360-0500-2-2-140HA05-HP132	30568713
5,10	6	82	44	35	36	SCD360-0510-2-2-140HA05-HP132	30568714
5,20	6	82	44	35	36	SCD360-0520-2-2-140HA05-HP132	30568715
5,30	6	82	44	35	36	SCD360-0530-2-2-140HA05-HP132	30568716
5,40	6	82	44	35	36	SCD360-0540-2-2-140HA05-HP132	30568717
5,50	6	82	44	35	36	SCD360-0550-2-2-140HA05-HP132	30568718
5,55*	6	82	44	35	36	SCD360-0555-2-2-140HA05-HP132	30568719
5,60	6	82	44	35	36	SCD360-0560-2-2-140HA05-HP132	30568720
5,70	6	82	44	35	36	SCD360-0570-2-2-140HA05-HP132	30568721
5,80	6	82	44	35	36	SCD360-0580-2-2-140HA05-HP132	30568722
5,90	6	82	44	35	36	SCD360-0590-2-2-140HA05-HP132	30568723
6,00	6	82	44	35	36	SCD360-0600-2-2-140HA05-HP132	30568724
6,10	8	91	53	43	36	SCD360-0610-2-2-140HA05-HP132	30568725
6,20	8	91	53	43	36	SCD360-0620-2-2-140HA05-HP132	30568726

ciąg dalszy na następnej stronie.

ECU-Drill-Steel | Wiertła spiralne z węgla spiekane SCD360 (5xD), zewnętrzne doprowadzenie chłodziwa

Wymiary						Typ chwytu HA	
d ₁ m7	d ₂ h6	l ₁	l ₂	l ₃	l ₄	Specyfikacja	Nr materiałowy
6,30	8	91	53	43	36	SCD360-0630-2-2-140HA05-HP132	30568727
6,40	8	91	53	43	36	SCD360-0640-2-2-140HA05-HP132	30568728
6,50	8	91	53	43	36	SCD360-0650-2-2-140HA05-HP132	30568729
6,60	8	91	53	43	36	SCD360-0660-2-2-140HA05-HP132	30568730
6,70	8	91	53	43	36	SCD360-0670-2-2-140HA05-HP132	30568731
6,80	8	91	53	43	36	SCD360-0680-2-2-140HA05-HP132	30568732
6,90	8	91	53	43	36	SCD360-0690-2-2-140HA05-HP132	30568733
7,00	8	91	53	43	36	SCD360-0700-2-2-140HA05-HP132	30568734
7,10	8	91	53	43	36	SCD360-0710-2-2-140HA05-HP132	30568735
7,20	8	91	53	43	36	SCD360-0720-2-2-140HA05-HP132	30568736
7,30	8	91	53	43	36	SCD360-0730-2-2-140HA05-HP132	30568737
7,40	8	91	53	43	36	SCD360-0740-2-2-140HA05-HP132	30568738
7,50	8	91	53	43	36	SCD360-0750-2-2-140HA05-HP132	30568740
7,60	8	91	53	43	36	SCD360-0760-2-2-140HA05-HP132	30568741
7,70	8	91	53	43	36	SCD360-0770-2-2-140HA05-HP132	30568742
7,80	8	91	53	43	36	SCD360-0780-2-2-140HA05-HP132	30568743
7,90	8	91	53	43	36	SCD360-0790-2-2-140HA05-HP132	30568744
8,00	8	91	53	43	36	SCD360-0800-2-2-140HA05-HP132	30568745
8,10	10	103	61	49	40	SCD360-0810-2-2-140HA05-HP132	30568746
8,20	10	103	61	49	40	SCD360-0820-2-2-140HA05-HP132	30568747
8,30	10	103	61	49	40	SCD360-0830-2-2-140HA05-HP132	30568748
8,40	10	103	61	49	40	SCD360-0840-2-2-140HA05-HP132	30568749
8,50	10	103	61	49	40	SCD360-0850-2-2-140HA05-HP132	30568750
8,60	10	103	61	49	40	SCD360-0860-2-2-140HA05-HP132	30568751
8,70	10	103	61	49	40	SCD360-0870-2-2-140HA05-HP132	30568752
8,80	10	103	61	49	40	SCD360-0880-2-2-140HA05-HP132	30568753
8,90	10	103	61	49	40	SCD360-0890-2-2-140HA05-HP132	30568754
9,00	10	103	61	49	40	SCD360-0900-2-2-140HA05-HP132	30568755
9,10	10	103	61	49	40	SCD360-0910-2-2-140HA05-HP132	30568756
9,20	10	103	61	49	40	SCD360-0920-2-2-140HA05-HP132	30568757
9,30*	10	103	61	49	40	SCD360-0930-2-2-140HA05-HP132	30568758
9,40	10	103	61	49	40	SCD360-0940-2-2-140HA05-HP132	30568759
9,50	10	103	61	49	40	SCD360-0950-2-2-140HA05-HP132	30568760
9,60	10	103	61	49	40	SCD360-0960-2-2-140HA05-HP132	30568761
9,70	10	103	61	49	40	SCD360-0970-2-2-140HA05-HP132	30568762
9,80	10	103	61	49	40	SCD360-0980-2-2-140HA05-HP132	30568763
9,90	10	103	61	49	40	SCD360-0990-2-2-140HA05-HP132	30568764
10,00	10	103	61	49	40	SCD360-1000-2-2-140HA05-HP132	30568765
10,10	12	118	71	56	45	SCD360-1010-2-2-140HA05-HP132	30568766
10,20	12	118	71	56	45	SCD360-1020-2-2-140HA05-HP132	30568767
10,30	12	118	71	56	45	SCD360-1030-2-2-140HA05-HP132	30568768
10,40	12	118	71	56	45	SCD360-1040-2-2-140HA05-HP132	30568769
10,50	12	118	71	56	45	SCD360-1050-2-2-140HA05-HP132	30568770
10,60	12	118	71	56	45	SCD360-1060-2-2-140HA05-HP132	30568771
10,80	12	118	71	56	45	SCD360-1080-2-2-140HA05-HP132	30568773
11,00	12	118	71	56	45	SCD360-1100-2-2-140HA05-HP132	30568775
11,10	12	118	71	56	45	SCD360-1110-2-2-140HA05-HP132	30568776
11,20*	12	118	71	56	45	SCD360-1120-2-2-140HA05-HP132	30568777
11,30	12	118	71	56	45	SCD360-1130-2-2-140HA05-HP132	30568778
11,40	12	118	71	56	45	SCD360-1140-2-2-140HA05-HP132	30568779
11,50	12	118	71	56	45	SCD360-1150-2-2-140HA05-HP132	30568780
11,60	12	118	71	56	45	SCD360-1160-2-2-140HA05-HP132	30568781
11,70	12	118	71	56	45	SCD360-1170-2-2-140HA05-HP132	30568782
11,80	12	118	71	56	45	SCD360-1180-2-2-140HA05-HP132	30568783
11,90	12	118	71	56	45	SCD360-1190-2-2-140HA05-HP132	30568784
12,00	12	118	71	56	45	SCD360-1200-2-2-140HA05-HP132	30568785
12,20	14	124	77	60	45	SCD360-1220-2-2-140HA05-HP132	30568786

ECU-Drill-Steel | Wiertła spiralne z węgla spiekane SCD360 (5xD), zewnętrzne doprowadzenie chłodziwa

Wymiary						Typ chwytu HA	
d ₁ m7	d ₂ h6	l ₁	l ₂	l ₃	l ₄	Specyfikacja	Nr materiałowy
12,50	14	124	77	60	45	SCD360-1250-2-2-140HA05-HP132	30568787
12,70	14	124	77	60	45	SCD360-1270-2-2-140HA05-HP132	30568788
12,80	14	124	77	60	45	SCD360-1280-2-2-140HA05-HP132	30568789
13,00	14	124	77	60	45	SCD360-1300-2-2-140HA05-HP132	30568790
13,10	14	124	77	60	45	SCD360-1310-2-2-140HA05-HP132	30569190
13,50	14	124	77	60	45	SCD360-1350-2-2-140HA05-HP132	30568792
13,70	14	124	77	60	45	SCD360-1370-2-2-140HA05-HP132	30568793
13,80	14	124	77	60	45	SCD360-1380-2-2-140HA05-HP132	30568794
14,00	14	124	77	60	45	SCD360-1400-2-2-140HA05-HP132	30568795
14,20	16	133	83	63	48	SCD360-1420-2-2-140HA05-HP132	30568796
14,50	16	133	83	63	48	SCD360-1450-2-2-140HA05-HP132	30568797
14,70	16	133	83	63	48	SCD360-1470-2-2-140HA05-HP132	30568798
14,80	16	133	83	63	48	SCD360-1480-2-2-140HA05-HP132	30568799
15,00	16	133	83	63	48	SCD360-1500-2-2-140HA05-HP132	30568800
15,50	16	133	83	63	48	SCD360-1550-2-2-140HA05-HP132	30568801
15,70	16	133	83	63	48	SCD360-1570-2-2-140HA05-HP132	30568802
15,80	16	133	83	63	48	SCD360-1580-2-2-140HA05-HP132	30568803
16,00	16	133	83	63	48	SCD360-1600-2-2-140HA05-HP132	30568804
16,50	18	143	93	71	48	SCD360-1650-2-2-140HA05-HP132	30568805
17,00	18	143	93	71	48	SCD360-1700-2-2-140HA05-HP132	30568807
17,50	18	143	93	71	48	SCD360-1750-2-2-140HA05-HP132	30568808
18,00	18	143	93	71	48	SCD360-1800-2-2-140HA05-HP132	30568810
18,50	20	153	101	77	50	SCD360-1850-2-2-140HA05-HP132	30568811
18,80	20	153	101	77	50	SCD360-1880-2-2-140HA05-HP132	30568812
19,00	20	153	101	77	50	SCD360-1900-2-2-140HA05-HP132	30568813
19,80	20	153	101	77	50	SCD360-1980-2-2-140HA05-HP132	30568815
20,00	20	153	101	77	50	SCD360-2000-2-2-140HA05-HP132	30568816

Możliwość konfiguracji parametrów



Typ chwytu:
Typ chwytu: HB | HE



Specyfikacja:
SCD360-0430-2-2-140[typ chwytu]05-HP132

Przykład:

SCD360-0430-2-2-140HE05-HP132

Typ chwytu HE

Wymiary podano w mm.

*Nadaje się w szczególności do wiercenia otworów pod gwinty wykonywanych gniotownikami.

Zalecane parametry skrawania - patrz koniec rozdziału.

Wersje specjalne i inne powłoki wg zapytania ofertowego.

ECU-Drill-Steel

Wiertła spiralne z węgla spiekane
SCD361 (8xD), wewnętrzne doprowadzenie chłodziwa

Wersja:

Średnica wiertła: 3,00 - 20,00 mm

Tolerancja otworu: \geq IT 9

Materiał skrawający: HP132

Liczba ostrzy: 2

Kąt wierzchołkowy: 135°

Kąt spirali: 30°

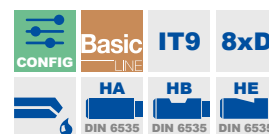
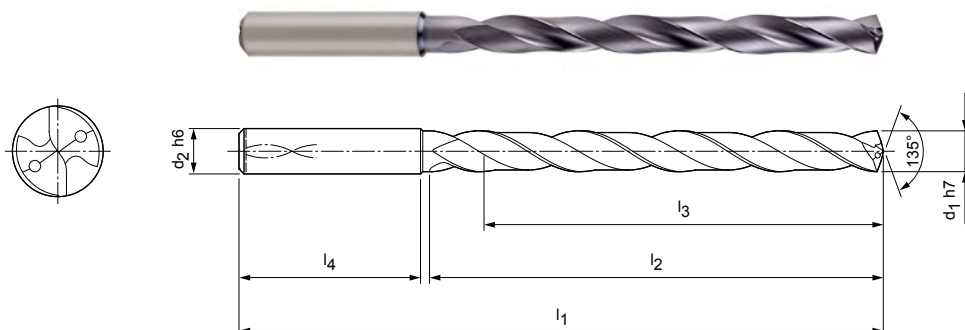

Magazynowa seria preferowana z typem chwytu HA

Wymiary						Typ chwytu HA	
d_1 h7	d_2 h6	l_1	l_2	l_3	l_4	Specyfikacja	Nr materiałowy
3,00	6	72	34	29	36	SCD361-0300-2-2-135HA08-HP132	30677713
3,10	6	72	34	29	36	SCD361-0310-2-2-135HA08-HP132	30677714
3,20	6	72	34	29	36	SCD361-0320-2-2-135HA08-HP132	30677715
3,30	6	72	34	29	36	SCD361-0330-2-2-135HA08-HP132	30677716
3,40	6	72	34	29	36	SCD361-0340-2-2-135HA08-HP132	30677717
3,50	6	72	34	29	36	SCD361-0350-2-2-135HA08-HP132	30677718
3,60	6	72	34	29	36	SCD361-0360-2-2-135HA08-HP132	30677719
3,70	6	72	34	29	36	SCD361-0370-2-2-135HA08-HP132	30677720
3,80	6	81	43	36	36	SCD361-0380-2-2-135HA08-HP132	30677721
3,90	6	81	43	36	36	SCD361-0390-2-2-135HA08-HP132	30677722
4,00	6	81	43	36	36	SCD361-0400-2-2-135HA08-HP132	30677723
4,10	6	81	43	36	36	SCD361-0410-2-2-135HA08-HP132	30677724
4,20	6	81	43	36	36	SCD361-0420-2-2-135HA08-HP132	30677725
4,30	6	81	43	36	36	SCD361-0430-2-2-135HA08-HP132	30677726
4,40	6	81	43	36	36	SCD361-0440-2-2-135HA08-HP132	30677727
4,50	6	81	43	36	36	SCD361-0450-2-2-135HA08-HP132	30677728
4,60	6	81	43	36	36	SCD361-0460-2-2-135HA08-HP132	30677729
4,70	6	81	43	36	36	SCD361-0470-2-2-135HA08-HP132	30677730
4,80	6	95	57	48	36	SCD361-0480-2-2-135HA08-HP132	30677731
4,90	6	95	57	48	36	SCD361-0490-2-2-135HA08-HP132	30677732
5,00	6	95	57	48	36	SCD361-0500-2-2-135HA08-HP132	30677733
5,10	6	95	57	48	36	SCD361-0510-2-2-135HA08-HP132	30677734
5,20	6	95	57	48	36	SCD361-0520-2-2-135HA08-HP132	30677735
5,30	6	95	57	48	36	SCD361-0530-2-2-135HA08-HP132	30677736
5,50	6	95	57	48	36	SCD361-0550-2-2-135HA08-HP132	30677738
5,70	6	95	57	48	36	SCD361-0570-2-2-135HA08-HP132	30677740
5,80	6	95	57	48	36	SCD361-0580-2-2-135HA08-HP132	30677741
5,90	6	95	57	48	36	SCD361-0590-2-2-135HA08-HP132	30677742
6,00	6	95	57	48	36	SCD361-0600-2-2-135HA08-HP132	30677743
6,10	8	114	76	64	36	SCD361-0610-2-2-135HA08-HP132	30677744
6,20	8	114	76	64	36	SCD361-0620-2-2-135HA08-HP132	30677745
6,30	8	114	76	64	36	SCD361-0630-2-2-135HA08-HP132	30677746
6,50	8	114	76	64	36	SCD361-0650-2-2-135HA08-HP132	30677748
6,60	8	114	76	64	36	SCD361-0660-2-2-135HA08-HP132	30677749
6,70	8	114	76	64	36	SCD361-0670-2-2-135HA08-HP132	30677751

ECU-Drill-Steel | wiertło spiralne z węgla spiekane SCD361 (8xD), wewnętrzny dopływ środka chłodzącego

Wymiary						Typ chwytu HA	
d ₁ h7	d ₂ h6	l ₁	l ₂	l ₃	l ₄	Specyfikacja	Nr materiałowy
6,80	8	114	76	64	36	SCD361-0680-2-2-135HA08-HP132	30677752
6,90	8	114	76	64	36	SCD361-0690-2-2-135HA08-HP132	30677753
7,00	8	114	76	64	36	SCD361-0700-2-2-135HA08-HP132	30677754
7,10	8	114	76	64	36	SCD361-0710-2-2-135HA08-HP132	30677755
7,40	8	114	76	64	36	SCD361-0740-2-2-135HA08-HP132	30677758
7,50	8	114	76	64	36	SCD361-0750-2-2-135HA08-HP132	30677759
7,70	8	114	76	64	36	SCD361-0770-2-2-135HA08-HP132	30677761
7,80	8	114	76	64	36	SCD361-0780-2-2-135HA08-HP132	30677762
7,90	8	114	76	64	36	SCD361-0790-2-2-135HA08-HP132	30677763
8,00	8	114	76	64	36	SCD361-0800-2-2-135HA08-HP132	30677764
8,10	10	142	95	80	40	SCD361-0810-2-2-135HA08-HP132	30677765
8,20	10	142	95	80	40	SCD361-0820-2-2-135HA08-HP132	30677766
8,30	10	142	95	80	40	SCD361-0830-2-2-135HA08-HP132	30677767
8,50	10	142	95	80	40	SCD361-0850-2-2-135HA08-HP132	30677769
8,60	10	142	95	80	40	SCD361-0860-2-2-135HA08-HP132	30677770
8,70	10	142	95	80	40	SCD361-0870-2-2-135HA08-HP132	30677772
8,80	10	142	95	80	40	SCD361-0880-2-2-135HA08-HP132	30677773
9,00	10	142	95	80	40	SCD361-0900-2-2-135HA08-HP132	30677775
9,10	10	142	95	80	40	SCD361-0910-2-2-135HA08-HP132	30677776
9,20	10	142	95	80	40	SCD361-0920-2-2-135HA08-HP132	30677777
9,30	10	142	95	80	40	SCD361-0930-2-2-135HA08-HP132	30677778
9,40	10	142	95	80	40	SCD431-0940-2-2-135HA08-HP765	30550363
9,50	10	142	95	80	40	SCD361-0950-2-2-135HA08-HP132	30677780
9,70	10	142	95	80	40	SCD361-0970-2-2-135HA08-HP132	30677782
9,80	10	142	95	80	40	SCD361-0980-2-2-135HA08-HP132	30677783
9,90	10	142	95	80	40	SCD361-0990-2-2-135HA08-HP132	30677784
10,00	10	142	95	80	40	SCD361-1000-2-2-135HA08-HP132	30677785
10,20	12	162	114	96	45	SCD361-1020-2-2-135HA08-HP132	30677787
10,30	12	162	114	96	45	SCD361-1030-2-2-135HA08-HP132	30677788
10,50	12	162	114	96	45	SCD361-1050-2-2-135HA08-HP132	30677790
10,80	12	162	114	96	45	SCD361-1080-2-2-135HA08-HP132	30677793
11,00	12	162	114	96	45	SCD361-1100-2-2-135HA08-HP132	30677795
11,20	12	162	114	96	45	SCD361-1120-2-2-135HA08-HP132	30677797
11,50	12	162	114	96	45	SCD361-1150-2-2-135HA08-HP132	30677800
11,70	12	162	114	96	45	SCD361-1170-2-2-135HA08-HP132	30677802
11,80	12	162	114	96	45	SCD361-1180-2-2-135HA08-HP132	30677803
12,00	12	162	114	96	45	SCD361-1200-2-2-135HA08-HP132	30677805
12,20	14	178	133	112	45	SCD361-1220-2-2-135HA08-HP132	30677806
12,50	14	178	133	112	45	SCD361-1250-2-2-135HA08-HP132	30677807
12,80	14	178	133	112	45	SCD361-1280-2-2-135HA08-HP132	30677808
13,00	14	178	133	112	45	SCD361-1300-2-2-135HA08-HP132	30677809
13,50	14	178	133	112	45	SCD361-1350-2-2-135HA08-HP132	30677811
13,80	14	178	133	112	45	SCD361-1380-2-2-135HA08-HP132	30677812
14,00	14	178	133	112	45	SCD361-1400-2-2-135HA08-HP132	30677813
14,50	16	203	152	128	48	SCD361-1450-2-2-135HA08-HP132	30677815
15,00	16	203	152	128	48	SCD361-1500-2-2-135HA08-HP132	30677817
15,50	16	203	152	128	48	SCD361-1550-2-2-135HA08-HP132	30677818
15,80	16	203	152	128	48	SCD361-1580-2-2-135HA08-HP132	30677819
16,00	16	203	152	128	48	SCD361-1600-2-2-135HA08-HP132	30677820
16,50	18	222	171	144	48	SCD361-1650-2-2-135HA08-HP132	30677821
17,00	18	222	171	144	48	SCD361-1700-2-2-135HA08-HP132	30677822
17,50	18	222	171	144	48	SCD361-1750-2-2-135HA08-HP132	30677823
18,00	18	222	171	144	48	SCD361-1800-2-2-135HA08-HP132	30677824
18,50	20	243	190	160	50	SCD361-1850-2-2-135HA08-HP132	30677825
19,00	20	243	190	160	50	SCD361-1900-2-2-135HA08-HP132	30677826
20,00	20	243	190	160	50	SCD361-2000-2-2-135HA08-HP132	30677828

Ciąg dalszy na następnej stronie.

ECU-Drill-Steel | wiertło spiralne z węgla spiekanego SCD361 (8xD), wewnętrzny dopływ środka chłodzącego

Możliwość konfiguracji parametrów



Typ chwytu:
Typ chwytu: HB | HE

**Specyfikacja:**

SCD361-0430-2-2-140[typ chwytu]08-HP132

Przykład:

SCD361-0430-2-2-140HE08-HP132

Typ chwytu HE

ECU-Drill-Steel

Wiertła spiralne z węgla spiekane
SCD361 (12xD), wewnętrzne doprowadzenie chłodziwa

Wersja:
Średnica wiertła: 3,00 - 18,00 mm
Tolerancja otworu: \geq IT 9
Materiał skrawający: HP132
Liczba ostrzy: 2
Kąt wierzchołkowy: 135°
Kąt spirali: 30°

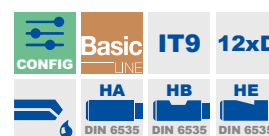
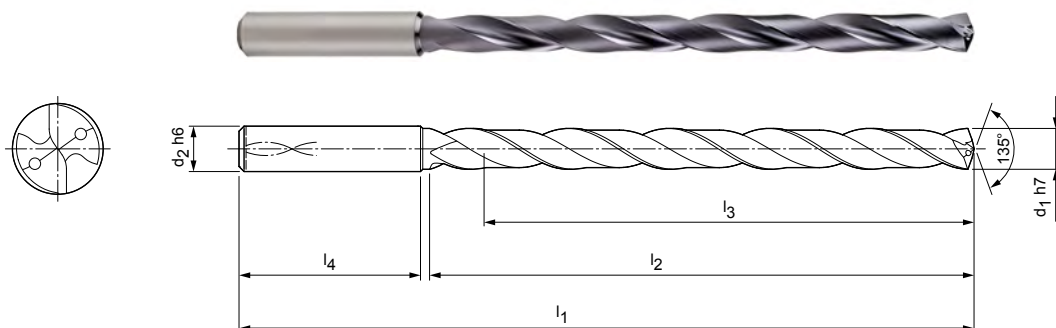

Magazynowa seria preferowana z typem chwytu HA

Wymiary						Typ chwytu HA	
d ₁ h7	d ₂ h6	l ₁	l ₂	l ₃	l ₄	Specyfikacja	Nr materiałowy
3,00	6	92	54	48	36	SCD361-0300-2-2-135HA12-HP132	30677829
3,10	6	92	54	48	36	SCD361-0310-2-2-135HA12-HP132	30677830
3,20	6	92	54	48	36	SCD361-0320-2-2-135HA12-HP132	30677831
3,30	6	92	54	48	36	SCD361-0330-2-2-135HA12-HP132	30677832
3,40	6	92	54	48	36	SCD361-0340-2-2-135HA12-HP132	30677833
3,50	6	92	54	48	36	SCD361-0350-2-2-135HA12-HP132	30677834
3,60	6	92	54	48	36	SCD361-0360-2-2-135HA12-HP132	30677835
3,70	6	92	54	48	36	SCD361-0370-2-2-135HA12-HP132	30677836
3,80	6	102	64	58	36	SCD361-0380-2-2-135HA12-HP132	30677837
3,90	6	102	64	58	36	SCD361-0390-2-2-135HA12-HP132	30677838
4,00	6	102	64	58	36	SCD361-0400-2-2-135HA12-HP132	30677839
4,10	6	102	64	58	36	SCD361-0410-2-2-135HA12-HP132	30677840
4,20	6	102	64	58	36	SCD361-0420-2-2-135HA12-HP132	30677841
4,30	6	102	64	58	36	SCD361-0430-2-2-135HA12-HP132	30677842
4,40	6	102	64	58	36	SCD361-0440-2-2-135HA12-HP132	30677843
4,50	6	102	64	58	36	SCD361-0450-2-2-135HA12-HP132	30677844
4,60	6	102	64	58	36	SCD361-0460-2-2-135HA12-HP132	30677845
4,70	6	102	64	58	36	SCD361-0470-2-2-135HA12-HP132	30677846
4,80	6	116	78	70	36	SCD361-0480-2-2-135HA12-HP132	30677847
4,90	6	116	78	70	36	SCD361-0490-2-2-135HA12-HP132	30677848
5,00	6	116	78	70	36	SCD361-0500-2-2-135HA12-HP132	30677849
5,10	6	116	78	70	36	SCD361-0510-2-2-135HA12-HP132	30677850
5,20	6	116	78	70	36	SCD361-0520-2-2-135HA12-HP132	30677851
5,50	6	116	78	70	36	SCD361-0550-2-2-135HA12-HP132	30677853
5,80	6	116	78	70	36	SCD361-0580-2-2-135HA12-HP132	30677854
6,00	6	116	78	70	36	SCD361-0600-2-2-135HA12-HP132	30677856
6,30	8	146	108	94	36	SCD361-0630-2-2-135HA12-HP132	30677859
6,50	8	146	108	94	36	SCD361-0650-2-2-135HA12-HP132	30677860
6,60	8	146	108	94	36	SCD361-0660-2-2-135HA12-HP132	30677861
6,80	8	146	108	94	36	SCD361-0680-2-2-135HA12-HP132	30677862
7,00	8	146	108	94	36	SCD361-0700-2-2-135HA12-HP132	30677863
7,40	8	146	108	94	36	SCD361-0740-2-2-135HA12-HP132	30677864
7,50	8	146	108	94	36	SCD361-0750-2-2-135HA12-HP132	30677865
7,80	8	146	108	94	36	SCD361-0780-2-2-135HA12-HP132	30677867
8,00	8	146	108	94	36	SCD361-0800-2-2-135HA12-HP132	30677869

ECU-Drill-Steel | wiertło spiralne z węgla spiekanego SCD361 (12xD), wewnętrzny dopływ środka chłodzącego

Wymiary						Typ chwytu HA	
d ₁ h7	d ₂ h6	l ₁	l ₂	l ₃	l ₄	Specyfikacja	Nr materiałowy
8,10	10	162	120	110	40	SCD361-0810-2-2-135HA12-HP132	30677870
8,20	10	162	120	110	40	SCD361-0820-2-2-135HA12-HP132	30677871
8,50	10	162	120	110	40	SCD361-0850-2-2-135HA12-HP132	30677874
9,00	10	162	120	110	40	SCD361-0900-2-2-135HA12-HP132	30677878
9,30	10	162	120	110	40	SCD361-0930-2-2-135HA12-HP132	30677881
9,50	10	162	120	110	40	SCD361-0950-2-2-135HA12-HP132	30677883
9,80	10	162	120	110	40	SCD361-0980-2-2-135HA12-HP132	30677885
10,00	10	162	120	110	40	SCD361-1000-2-2-135HA12-HP132	30677887
10,20	12	204	156	142	45	SCD361-1020-2-2-135HA12-HP132	30677888
10,50	12	204	156	142	45	SCD361-1050-2-2-135HA12-HP132	30677889
11,00	12	204	156	142	45	SCD361-1100-2-2-135HA12-HP132	30677891
11,50	12	204	156	142	45	SCD361-1150-2-2-135HA12-HP132	30677893
11,80	12	204	156	142	45	SCD361-1180-2-2-135HA12-HP132	30677894
12,00	12	204	156	142	45	SCD361-1200-2-2-135HA12-HP132	30677895
12,50	14	230	182	166	45	SCD361-1250-2-2-135HA12-HP132	30677896
13,00	14	230	182	166	45	SCD361-1300-2-2-135HA12-HP132	30677897
13,50	14	230	182	166	45	SCD361-1350-2-2-135HA12-HP132	30677899
14,00	14	230	182	166	45	SCD361-1400-2-2-135HA12-HP132	30677900
15,00	16	260	208	192	48	SCD361-1500-2-2-135HA12-HP132	30677903
16,00	16	260	208	192	48	SCD361-1600-2-2-135HA12-HP132	30677906
17,00	18	285	234	216	48	SCD361-1700-2-2-135HA12-HP132	30677908
17,50	18	285	234	216	48	SCD361-1750-2-2-135HA12-HP132	30677909
18,00	18	285	234	216	48	SCD361-1800-2-2-135HA12-HP132	30677910

Możliwość konfiguracji parametrów



Typ chwytu:
Typ chwytu: HB | HE



Specyfikacja:
SCD361-0430-2-2-140[typ chwytu]12-HP132

Przykład:

SCD361-0430-2-2-140HE12-HP132

Typ chwytu HE

Wymiary podano w mm.

Zalecane parametry skrawania - patrz koniec rozdziału.

Wersje specjalne i inne powłoki wg zapytania ofertowego.

MEGA-Drill-Inox

Wiertła spiralne z węgla spiekane
SCD120 (3xD), zewnętrzne doprowadzenie chłodziwa

Wersja:
Średnica wiertła: 2,00 – 20,00 mm
Tolerancja otworu: \geq IT 9
Materiał skrawający: HP835
Liczba ostrzy: 2
Liczba tyselek: 2
Kąt wierzchołkowy: 140°
Kąt spirali: 30°

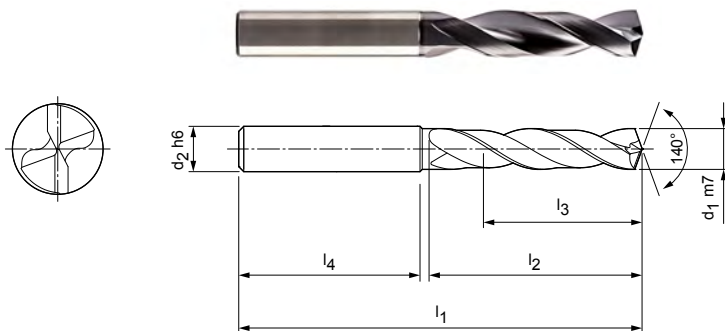

Magazynowa seria preferowana z typem chwytu HA

Wymiary						Typ chwytu HA	
d ₁ m7	d ₂ h6	l ₁	l ₂	l ₃	l ₄	Specyfikacja	Nr materiałowy
2,00	6	58	16	11	36	SCD120-0200-2-2-140HA03-HP835	30444703
2,10	6	58	16	11	36	SCD120-0210-2-2-140HA03-HP835	30453589
2,20	6	58	16	11	36	SCD120-0220-2-2-140HA03-HP835	30453826
2,30	6	58	16	11	36	SCD120-0230-2-2-140HA03-HP835	30453515
2,33	6	58	16	11	36	SCD120-0233-2-2-140HA03-HP835	30453605
2,40	6	58	16	11	36	SCD120-0240-2-2-140HA03-HP835	30444776
2,43	6	58	16	11	36	SCD120-0243-2-2-140HA03-HP835	30453606
2,50	6	58	16	11	36	SCD120-0250-2-2-140HA03-HP835	30451313
2,55	6	62	22	14	36	SCD120-0255-2-2-140HA03-HP835	30453607
2,60	6	58	16	11	36	SCD120-0260-2-2-140HA03-HP835	30453541
2,62	6	58	16	11	36	SCD120-0262-2-2-140HA03-HP835	30453608
2,70	6	58	16	11	36	SCD120-0270-2-2-140HA03-HP835	30453525
2,80	6	58	16	11	36	SCD120-0280-2-2-140HA03-HP835	30453502
2,90	6	58	16	11	36	SCD120-0290-2-2-140HA03-HP835	30453546
3,00	6	62	22	14	36	SCD120-0300-2-2-140HA03-HP835	30390310
3,10	6	62	22	14	36	SCD120-0310-2-2-140HA03-HP835	30390311
3,15	6	62	22	14	36	SCD120-0315-2-2-140HA03-HP835	30453609
3,20	6	62	22	14	36	SCD120-0320-2-2-140HA03-HP835	30390312
3,22	6	62	22	14	36	SCD120-0322-2-2-140HA03-HP835	30453610
3,25	6	62	22	14	36	SCD120-0325-2-2-140HA03-HP835	30453611
3,30	6	62	22	14	36	SCD120-0330-2-2-140HA03-HP835	30390313
3,40	6	62	22	14	36	SCD120-0340-2-2-140HA03-HP835	30390314
3,50	6	62	22	14	36	SCD120-0350-2-2-140HA03-HP835	30390315
3,60	6	62	22	14	36	SCD120-0360-2-2-140HA03-HP835	30390316
3,70	6	62	22	14	36	SCD120-0370-2-2-140HA03-HP835	30390317
3,80	6	66	26	17	36	SCD120-0380-2-2-140HA03-HP835	30390318
3,90	6	66	26	17	36	SCD120-0390-2-2-140HA03-HP835	30390319
4,00	6	66	26	17	36	SCD120-0400-2-2-140HA03-HP835	30390320
4,05	6	66	26	17	36	SCD120-0405-2-2-140HA03-HP835	30445425
4,10	6	66	26	17	36	SCD120-0410-2-2-140HA03-HP835	30390321
4,20	6	66	26	17	36	SCD120-0420-2-2-140HA03-HP835	30390322
4,30	6	66	26	17	36	SCD120-0430-2-2-140HA03-HP835	30390323
4,35	6	66	26	17	36	SCD120-0435-2-2-140HA03-HP835	30453613
4,40	6	66	26	17	36	SCD120-0440-2-2-140HA03-HP835	30390324
4,50	6	66	26	17	36	SCD120-0450-2-2-140HA03-HP835	30390325

MEGA-Drill-Inox | Wiertła spiralne z węgla spiekane SCD120 (3xD), zewnętrzne doprowadzenie chłodziwa

Wymiary						Typ chwytu HA	
d ₁ m7	d ₂ h6	l ₁	l ₂	l ₃	l ₄	Specyfikacja	Nr materiałowy
4,60	6	66	26	17	36	SCD120-0460-2-2-140HA03-HP835	30390326
4,65	6	66	26	17	36	SCD120-0465-2-2-140HA03-HP835	30452080
4,70	6	66	26	17	36	SCD120-0470-2-2-140HA03-HP835	30390327
4,80	6	66	30	20	36	SCD120-0480-2-2-140HA03-HP835	30390328
4,90	6	66	30	20	36	SCD120-0490-2-2-140HA03-HP835	30390329
5,00	6	66	30	20	36	SCD120-0500-2-2-140HA03-HP835	30390330
5,03	6	66	30	20	36	SCD120-0503-2-2-140HA03-HP835	30453912
5,10	6	66	30	20	36	SCD120-0510-2-2-140HA03-HP835	30390331
5,20	6	66	30	20	36	SCD120-0520-2-2-140HA03-HP835	30390332
5,30	6	66	30	20	36	SCD120-0530-2-2-140HA03-HP835	30390333
5,40	6	66	30	20	36	SCD120-0540-2-2-140HA03-HP835	30390334
5,50	6	66	30	20	36	SCD120-0550-2-2-140HA03-HP835	30390335
5,55	6	66	30	20	36	SCD120-0555-2-2-140HA03-HP835	30452081
5,60	6	66	30	20	36	SCD120-0560-2-2-140HA03-HP835	30390336
5,70	6	66	30	20	36	SCD120-0570-2-2-140HA03-HP835	30390337
5,80	6	66	30	20	36	SCD120-0580-2-2-140HA03-HP835	30390338
5,90	6	66	30	20	36	SCD120-0590-2-2-140HA03-HP835	30390339
6,00	6	66	30	20	36	SCD120-0600-2-2-140HA03-HP835	30390340
6,10	8	79	38	24	36	SCD120-0610-2-2-140HA03-HP835	30390341
6,20	8	79	38	24	36	SCD120-0620-2-2-140HA03-HP835	30390342
6,30	8	79	38	24	36	SCD120-0630-2-2-140HA03-HP835	30390343
6,40	8	79	38	24	36	SCD120-0640-2-2-140HA03-HP835	30390344
6,50	8	79	38	24	36	SCD120-0650-2-2-140HA03-HP835	30390345
6,60	8	79	38	24	36	SCD120-0660-2-2-140HA03-HP835	30390346
6,70	8	79	38	24	36	SCD120-0670-2-2-140HA03-HP835	30390347
6,80	8	79	38	24	36	SCD120-0680-2-2-140HA03-HP835	30390348
6,90	8	79	38	24	36	SCD120-0690-2-2-140HA03-HP835	30390349
7,00	8	79	38	24	36	SCD120-0700-2-2-140HA03-HP835	30390350
7,20	8	79	42	29	36	SCD120-0720-2-2-140HA03-HP835	30390352
7,40	8	79	42	29	36	SCD120-0740-2-2-140HA03-HP835	30390354
7,45	8	79	42	29	36	SCD120-0745-2-2-140HA03-HP835	30453616
7,50	8	79	42	29	36	SCD120-0750-2-2-140HA03-HP835	30390355
7,70	8	79	42	29	36	SCD120-0770-2-2-140HA03-HP835	30390357
7,80	8	79	42	29	36	SCD120-0780-2-2-140HA03-HP835	30390358
7,90	8	79	42	29	36	SCD120-0790-2-2-140HA03-HP835	30390359
8,00	8	79	42	29	36	SCD120-0800-2-2-140HA03-HP835	30390360
8,10	10	89	49	35	40	SCD120-0810-2-2-140HA03-HP835	30390361
8,20	10	89	49	35	40	SCD120-0820-2-2-140HA03-HP835	30390362
8,30	10	89	49	35	40	SCD120-0830-2-2-140HA03-HP835	30390363
8,40	10	89	49	35	40	SCD120-0840-2-2-140HA03-HP835	30390364
8,50	10	89	49	35	40	SCD120-0850-2-2-140HA03-HP835	30390365
8,60	10	89	49	35	40	SCD120-0860-2-2-140HA03-HP835	30390366
8,70	10	89	49	35	40	SCD120-0870-2-2-140HA03-HP835	30390367
8,80	10	89	49	35	40	SCD120-0880-2-2-140HA03-HP835	30390368
8,90	10	89	49	35	40	SCD120-0890-2-2-140HA03-HP835	30390369
9,00	10	89	49	35	40	SCD120-0900-2-2-140HA03-HP835	30390370
9,10	10	89	49	35	40	SCD120-0910-2-2-140HA03-HP835	30390371
9,50	10	89	49	35	40	SCD120-0950-2-2-140HA03-HP835	30390375
9,80	10	89	49	35	40	SCD120-0980-2-2-140HA03-HP835	30390378
9,90	10	89	49	35	40	SCD120-0990-2-2-140HA03-HP835	30390379
10,00	10	89	49	35	40	SCD120-1000-2-2-140HA03-HP835	30390380
10,10	12	102	56	40	45	SCD120-1010-2-2-140HA03-HP835	30390381
10,20	12	102	56	40	45	SCD120-1020-2-2-140HA03-HP835	30390382
10,30	12	102	56	40	45	SCD120-1030-2-2-140HA03-HP835	30390383
10,50	12	102	56	40	45	SCD120-1050-2-2-140HA03-HP835	30390385
11,00	12	102	56	40	45	SCD120-1100-2-2-140HA03-HP835	30390390
11,50	12	102	56	40	45	SCD120-1150-2-2-140HA03-HP835	30390395

MEGA-Drill-Inox | Wiertła spiralne z węgla spiekane SCD120 (3xD), zewnętrzne doprowadzenie chłodziwa

Wymiary						Typ chwytu HA	
d ₁ m7	d ₂ h6	l ₁	l ₂	l ₃	l ₄	Specyfikacja	Nr materiałowy
11,80	12	102	56	40	45	SCD120-1180-2-2-140HA03-HP835	30390398
12,00	12	102	56	40	45	SCD120-1200-2-2-140HA03-HP835	30390400
12,15	14	107	61	43	45	SCD120-1215-2-2-140HA03-HP835	30453623
12,50	14	107	61	43	45	SCD120-1250-2-2-140HA03-HP835	30390401
12,80	14	107	61	43	45	SCD120-1280-2-2-140HA03-HP835	30445978
13,00	14	107	61	43	45	SCD120-1300-2-2-140HA03-HP835	30390402
13,80	14	107	61	43	45	SCD120-1380-2-2-140HA03-HP835	30445979
14,00	14	107	61	43	45	SCD120-1400-2-2-140HA03-HP835	30390404
15,00	16	115	65	45	48	SCD120-1500-2-2-140HA03-HP835	30390406
16,00	16	115	65	45	48	SCD120-1600-2-2-140HA03-HP835	30390408
17,00	18	123	73	51	48	SCD120-1700-2-2-140HA03-HP835	30390410
18,00	18	123	73	51	48	SCD120-1800-2-2-140HA03-HP835	30390412
19,00	20	131	79	55	50	SCD120-1900-2-2-140HA03-HP835	30390414

Możliwość konfiguracji parametrów



Średnica:
możliwość wyboru średnicy w krokach co 0,01 mm





Typ chwytu:
Typ chwytu: HB | HE

Specyfikacja:
SCD120-[średnica]-2-2-140[typ chwytu]03-HP835

Wymiary typoszeregu z możliwością konfiguracji parametrów

d ₁ min.	d ₁ max.	d ₂ h6	l ₁	l ₂	l ₃	l ₄
3,00	3,70	6	62	22	14	36
3,71	4,70	6	66	26	17	36
4,71	6,00	6	66	30	20	36
6,01	7,00	8	79	38	24	36
7,01	8,00	8	79	42	29	36
8,01	10,00	10	89	49	35	40
10,01	12,00	12	102	56	40	45
12,01	14,00	14	107	61	43	45
14,01	16,00	16	115	65	45	48
16,01	18,00	18	123	73	51	48
18,01	20,00	20	131	79	55	50

Przykład:

SCD120-0431-2-2-140HE03-HP835

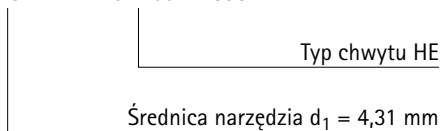

Wymiary podano w mm.

Zalecane parametry skrawania - patrz koniec rozdziału.

Wersje specjalne i inne powłoki wg zapytania ofertowego.

MEGA-Drill-Inox

Wiertła spiralne z węgla spiekane
SCD121 (3xD), wewnętrzne doprowadzenie chłodziwa

Wersja:

Średnica wiertła: 3,00 – 20,00 mm
Tolerancja otworu: \geq IT 9
Materiał skrawający: HP835
Liczba ostrzy: 2
Liczba tyselek: 2
Kąt wierzchołkowy: 140°
Kąt spirali: 30°

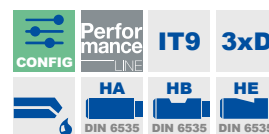
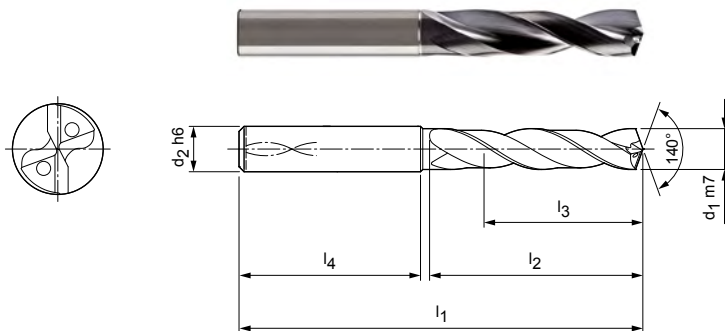

Magazynowa seria preferowana z typem chwytu HA

Wymiary						Typ chwytu HA	
d ₁ m7	d ₂ h6	l ₁	l ₂	l ₃	l ₄	Specyfikacja	Nr materiałowy
3,00	6	62	22	14	36	SCD121-0300-2-2-140HA03-HP835	30390523
3,05	6	62	22	14	36	SCD121-0305-2-2-140HA03-HP835	30445910
3,15	6	62	22	14	36	SCD121-0315-2-2-140HA03-HP835	30453629
3,20	6	62	22	14	36	SCD121-0320-2-2-140HA03-HP835	30390525
3,25	6	62	22	14	36	SCD121-0325-2-2-140HA03-HP835	30453631
3,30	6	62	22	14	36	SCD121-0330-2-2-140HA03-HP835	30390526
3,40	6	62	22	14	36	SCD121-0340-2-2-140HA03-HP835	30390527
3,50	6	62	22	14	36	SCD121-0350-2-2-140HA03-HP835	30390528
3,60	6	62	22	14	36	SCD121-0360-2-2-140HA03-HP835	30390529
3,70	6	62	22	14	36	SCD121-0370-2-2-140HA03-HP835	30390530
3,80	6	66	26	17	36	SCD121-0380-2-2-140HA03-HP835	30390531
3,90	6	66	26	17	36	SCD121-0390-2-2-140HA03-HP835	30390532
4,00	6	66	26	17	36	SCD121-0400-2-2-140HA03-HP835	30390533
4,10	6	66	26	17	36	SCD121-0410-2-2-140HA03-HP835	30390534
4,20	6	66	26	17	36	SCD121-0420-2-2-140HA03-HP835	30390535
4,30	6	66	26	17	36	SCD121-0430-2-2-140HA03-HP835	30390536
4,35	6	66	26	17	36	SCD121-0435-2-2-140HA03-HP835	30453633
4,40	6	66	26	17	36	SCD121-0440-2-2-140HA03-HP835	30390537
4,50	6	66	26	17	36	SCD121-0450-2-2-140HA03-HP835	30390538
4,65	6	66	26	17	36	SCD121-0465-2-2-140HA03-HP835	30438861
4,70	6	66	26	17	36	SCD121-0470-2-2-140HA03-HP835	30390540
4,80	6	66	30	20	36	SCD121-0480-2-2-140HA03-HP835	30390541
5,00	6	66	30	20	36	SCD121-0500-2-2-140HA03-HP835	30390543
5,10	6	66	30	20	36	SCD121-0510-2-2-140HA03-HP835	30390544
5,20	6	66	30	20	36	SCD121-0520-2-2-140HA03-HP835	30390545
5,30	6	66	30	20	36	SCD121-0530-2-2-140HA03-HP835	30390546
5,40	6	66	30	20	36	SCD121-0540-2-2-140HA03-HP835	30390547
5,50	6	66	30	20	36	SCD121-0550-2-2-140HA03-HP835	30390548
5,55	6	66	30	20	36	SCD121-0555-2-2-140HA03-HP835	30439052
5,60	6	66	30	20	36	SCD121-0560-2-2-140HA03-HP835	30390549
5,70	6	66	30	20	36	SCD121-0570-2-2-140HA03-HP835	30390550
5,80	6	66	30	20	36	SCD121-0580-2-2-140HA03-HP835	30390551
5,90	6	66	30	20	36	SCD121-0590-2-2-140HA03-HP835	30390552
5,95	6	66	30	20	36	SCD121-0595-2-2-140HA03-HP835	30453636
6,00	6	66	30	20	36	SCD121-0600-2-2-140HA03-HP835	30390553

MEGA-Drill-Inox | Wiertła spiralne z węgla spiekane SCD121 (3xD), wewnętrzne doprowadzenie chłodziwa

Wymiary						Typ chwytu HA	
d ₁ m7	d ₂ h6	l ₁	l ₂	l ₃	l ₄	Specyfikacja	Nr materiałowy
6,10	8	79	38	24	36	SCD121-0610-2-2-140HA03-HP835	30390554
6,20	8	79	38	24	36	SCD121-0620-2-2-140HA03-HP835	30390555
6,30	8	79	38	24	36	SCD121-0630-2-2-140HA03-HP835	30390556
6,40	8	79	38	24	36	SCD121-0640-2-2-140HA03-HP835	30390557
6,50	8	79	38	24	36	SCD121-0650-2-2-140HA03-HP835	30390558
6,60	8	79	38	24	36	SCD121-0660-2-2-140HA03-HP835	30390559
6,70	8	79	38	24	36	SCD121-0670-2-2-140HA03-HP835	30390560
6,80	8	79	38	24	36	SCD121-0680-2-2-140HA03-HP835	30390561
6,90	8	79	38	24	36	SCD121-0690-2-2-140HA03-HP835	30390562
7,00	8	79	38	24	36	SCD121-0700-2-2-140HA03-HP835	30390563
7,10	8	79	42	29	36	SCD121-0710-2-2-140HA03-HP835	30390564
7,20	8	79	42	29	36	SCD121-0720-2-2-140HA03-HP835	30390565
7,30	8	79	42	29	36	SCD121-0730-2-2-140HA03-HP835	30390566
7,40	8	79	42	29	36	SCD121-0740-2-2-140HA03-HP835	30390567
7,45	8	79	42	29	36	SCD121-0745-2-2-140HA03-HP835	30453637
7,50	8	79	42	29	36	SCD121-0750-2-2-140HA03-HP835	30390568
7,70	8	79	42	29	36	SCD121-0770-2-2-140HA03-HP835	30390570
7,80	8	79	42	29	36	SCD121-0780-2-2-140HA03-HP835	30390571
7,90	8	79	42	29	36	SCD121-0790-2-2-140HA03-HP835	30390572
8,00	8	79	42	29	36	SCD121-0800-2-2-140HA03-HP835	30390573
8,10	10	89	49	35	40	SCD121-0810-2-2-140HA03-HP835	30390574
8,20	10	89	49	35	40	SCD121-0820-2-2-140HA03-HP835	30390575
8,30	10	89	49	35	40	SCD121-0830-2-2-140HA03-HP835	30390576
8,40	10	89	49	35	40	SCD121-0840-2-2-140HA03-HP835	30390577
8,50	10	89	49	35	40	SCD121-0850-2-2-140HA03-HP835	30390578
8,60	10	89	49	35	40	SCD121-0860-2-2-140HA03-HP835	30390579
8,70	10	89	49	35	40	SCD121-0870-2-2-140HA03-HP835	30390580
8,80	10	89	49	35	40	SCD121-0880-2-2-140HA03-HP835	30390581
9,00	10	89	49	35	40	SCD121-0900-2-2-140HA03-HP835	30390583
9,10	10	89	49	35	40	SCD121-0910-2-2-140HA03-HP835	30390584
9,20	10	89	49	35	40	SCD121-0920-2-2-140HA03-HP835	30390585
9,30	10	89	49	35	40	SCD121-0930-2-2-140HA03-HP835	30390586
9,35	10	89	49	35	40	SCD121-0935-2-2-140HA03-HP835	30450663
9,40	10	89	49	35	40	SCD121-0940-2-2-140HA03-HP835	30390587
9,50	10	89	49	35	40	SCD121-0950-2-2-140HA03-HP835	30390588
9,70	10	89	49	35	40	SCD121-0970-2-2-140HA03-HP835	30390590
9,80	10	89	49	35	40	SCD121-0980-2-2-140HA03-HP835	30390591
9,90	10	89	49	35	40	SCD121-0990-2-2-140HA03-HP835	30390592
10,00	10	89	49	35	40	SCD121-1000-2-2-140HA03-HP835	30390593
10,20	12	102	56	40	45	SCD121-1020-2-2-140HA03-HP835	30390595
10,30	12	102	56	40	45	SCD121-1030-2-2-140HA03-HP835	30390596
10,40	12	102	56	40	45	SCD121-1040-2-2-140HA03-HP835	30390597
10,50	12	102	56	40	45	SCD121-1050-2-2-140HA03-HP835	30390598
10,70	12	102	56	40	45	SCD121-1070-2-2-140HA03-HP835	30390600
10,80	12	102	56	40	45	SCD121-1080-2-2-140HA03-HP835	30390601
11,00	12	102	56	40	45	SCD121-1100-2-2-140HA03-HP835	30390603
11,10	12	102	56	40	45	SCD121-1110-2-2-140HA03-HP835	30390604
11,30	12	102	56	40	45	SCD121-1130-2-2-140HA03-HP835	30390606
11,50	12	102	56	40	45	SCD121-1150-2-2-140HA03-HP835	30390608
11,70	12	102	56	40	45	SCD121-1170-2-2-140HA03-HP835	30390610
11,80	12	102	56	40	45	SCD121-1180-2-2-140HA03-HP835	30390611
12,00	12	102	56	40	45	SCD121-1200-2-2-140HA03-HP835	30390613
12,15	14	107	61	43	45	SCD121-1215-2-2-140HA03-HP835	30453644
12,50	14	107	61	43	45	SCD121-1250-2-2-140HA03-HP835	30443976
12,80	14	107	61	43	45	SCD121-1280-2-2-140HA03-HP835	30445992
13,00	14	107	61	43	45	SCD121-1300-2-2-140HA03-HP835	30444778
13,50	14	107	61	43	45	SCD121-1350-2-2-140HA03-HP835	30390614

Ciąg dalszy na następnej stronie.

MEGA-Drill-Inox | Wiertła spiralne z węgla spiekane SCD121 (3xD), wewnętrzne doprowadzenie chłodziwa

Wymiary						Typ chwytu HA	
d ₁ m7	d ₂ h6	l ₁	l ₂	l ₃	l ₄	Specyfikacja	Nr materiałowy
13,80	14	107	61	43	45	SCD121-1380-2-2-140HA03-HP835	30445993
14,00	14	107	61	43	45	SCD121-1400-2-2-140HA03-HP835	30445050
14,50	16	115	65	45	48	SCD121-1450-2-2-140HA03-HP835	30390615
15,00	16	115	65	45	48	SCD121-1500-2-2-140HA03-HP835	30390616
15,50	16	115	65	45	48	SCD121-1550-2-2-140HA03-HP835	30442531
15,80	16	115	65	45	48	SCD121-1580-2-2-140HA03-HP835	30445995
16,00	16	115	65	45	48	SCD121-1600-2-2-140HA03-HP835	30390617
17,50	18	123	73	51	48	SCD121-1750-2-2-140HA03-HP835	30390620
18,00	18	123	73	51	48	SCD121-1800-2-2-140HA03-HP835	30390621
20,00	20	131	79	55	50	SCD121-2000-2-2-140HA03-HP835	30390625

Możliwość konfiguracji parametrów



Średnica:
możliwość wyboru średnicy w krokach
co 0,01 mm





Typ chwytu:
Typ chwytu: HB | HE

Specyfikacja:
SCD121-[średnica]-2-2-140[typ chwytu]03-HP835

Wymiary typoszeregu z możliwością konfiguracji parametrów

d ₁ min.	d ₁ max.	d ₂ h6	l ₁	l ₂	l ₃	l ₄
3,71	4,70	6	66	26	17	36
4,71	6,00	6	66	30	20	36
6,01	7,00	8	79	38	24	36
7,01	8,00	8	79	42	29	36
8,01	10,00	10	89	49	35	40
10,01	12,00	12	102	56	40	45
12,01	14,00	14	107	61	43	45
14,01	16,00	16	115	65	45	48
16,01	18,00	18	123	73	51	48
18,01	20,00	20	131	79	55	50
18,01	20,00	20	131	79	55	50

Przykład:

SCD121-0431-2-2-140HE03-HP835

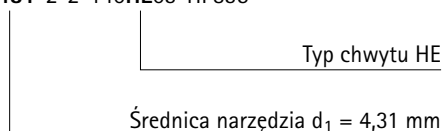

Wymiary podano w mm.

Zalecane parametry skrawania - patrz koniec rozdziału.

Wersje specjalne i inne powłoki wg zapytania ofertowego.

MEGA-Drill-Inox

Wiertła spiralne z węgla spiekane
SCD120 (5xD), zewnętrzne doprowadzenie chłodziwa

Wersja:
Średnica wiertła: 3,00 – 20,00 mm
Tolerancja otworu: ≥ IT 9
Materiał skrawający: HP835
Liczba ostrzy: 2
Liczba tyselek: 2
Kąt wierzchołkowy: 140°
Kąt spirali: 30°

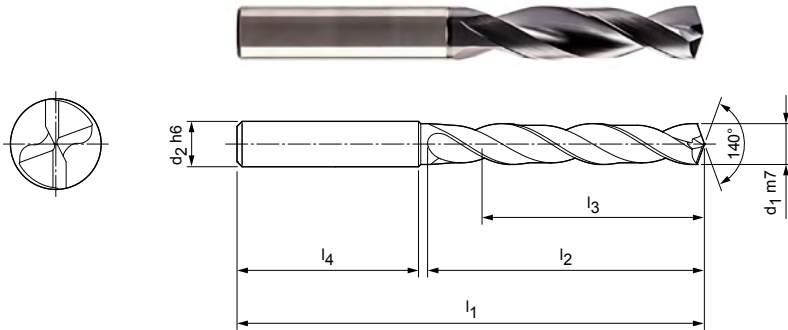

Magazynowa seria preferowana z typem chwytu HA

Wymiary						Typ chwytu HA	
d ₁ m7	d ₂ h6	l ₁	l ₂	l ₃	l ₄	Specyfikacja	Nr materiałowy
3,00	6	66	28	23	36	SCD120-0300-2-2-140HA05-HP835	30390730
3,10	6	66	28	23	36	SCD120-0310-2-2-140HA05-HP835	30390731
3,20	6	66	28	23	36	SCD120-0320-2-2-140HA05-HP835	30390732
3,30	6	66	28	23	36	SCD120-0330-2-2-140HA05-HP835	30390733
3,40	6	66	28	23	36	SCD120-0340-2-2-140HA05-HP835	30390734
3,50	6	66	28	23	36	SCD120-0350-2-2-140HA05-HP835	30390735
3,60	6	66	28	23	36	SCD120-0360-2-2-140HA05-HP835	30390736
3,70	6	66	28	23	36	SCD120-0370-2-2-140HA05-HP835	30390737
3,80	6	74	36	29	36	SCD120-0380-2-2-140HA05-HP835	30390738
3,90	6	74	36	29	36	SCD120-0390-2-2-140HA05-HP835	30390739
4,00	6	74	36	29	36	SCD120-0400-2-2-140HA05-HP835	30390740
4,10	6	74	36	29	36	SCD120-0410-2-2-140HA05-HP835	30390741
4,20	6	74	36	29	36	SCD120-0420-2-2-140HA05-HP835	30390742
4,30	6	74	36	29	36	SCD120-0430-2-2-140HA05-HP835	30390743
4,40	6	74	36	29	36	SCD120-0440-2-2-140HA05-HP835	30390744
4,50	6	74	36	29	36	SCD120-0450-2-2-140HA05-HP835	30390745
4,60	6	74	36	29	36	SCD120-0460-2-2-140HA05-HP835	30390746
4,70	6	74	36	29	36	SCD120-0470-2-2-140HA05-HP835	30390747
4,80	6	82	44	35	36	SCD120-0480-2-2-140HA05-HP835	30390748
4,90	6	82	44	35	36	SCD120-0490-2-2-140HA05-HP835	30390749
5,00	6	82	44	35	36	SCD120-0500-2-2-140HA05-HP835	30390750
5,10	6	82	44	35	36	SCD120-0510-2-2-140HA05-HP835	30390751
5,20	6	82	44	35	36	SCD120-0520-2-2-140HA05-HP835	30390752
5,30	6	82	44	35	36	SCD120-0530-2-2-140HA05-HP835	30390753
5,40	6	82	44	35	36	SCD120-0540-2-2-140HA05-HP835	30390754
5,50	6	82	44	35	36	SCD120-0550-2-2-140HA05-HP835	30390755
5,60	6	82	44	35	36	SCD120-0560-2-2-140HA05-HP835	30390756
5,80	6	82	44	35	36	SCD120-0580-2-2-140HA05-HP835	30390758
6,00	6	82	44	35	36	SCD120-0600-2-2-140HA05-HP835	30390760
6,10	8	91	53	43	36	SCD120-0610-2-2-140HA05-HP835	30390761
6,20	8	91	53	43	36	SCD120-0620-2-2-140HA05-HP835	30390762
6,30	8	91	53	43	36	SCD120-0630-2-2-140HA05-HP835	30390763
6,40	8	91	53	43	36	SCD120-0640-2-2-140HA05-HP835	30390764
6,50	8	91	53	43	36	SCD120-0650-2-2-140HA05-HP835	30390765
6,60	8	91	53	43	36	SCD120-0660-2-2-140HA05-HP835	30390766

MEGA-Drill-Inox | Wiertła spiralne z węgla spiekane SCD120 (5xD), zewnętrzne doprowadzenie chłodziwa

Wymiary						Typ chwytu HA	
d ₁ m7	d ₂ h6	l ₁	l ₂	l ₃	l ₄	Specyfikacja	Nr materiałowy
6,70	8	91	53	43	36	SCD120-0670-2-2-140HA05-HP835	30390767
6,80	8	91	53	43	36	SCD120-0680-2-2-140HA05-HP835	30390768
6,90	8	91	53	43	36	SCD120-0690-2-2-140HA05-HP835	30390769
7,00	8	91	53	43	36	SCD120-0700-2-2-140HA05-HP835	30390770
7,10	8	91	53	43	36	SCD120-0710-2-2-140HA05-HP835	30390771
7,40	8	91	53	43	36	SCD120-0740-2-2-140HA05-HP835	30390774
7,50	8	91	53	43	36	SCD120-0750-2-2-140HA05-HP835	30390775
7,60	8	91	53	43	36	SCD120-0760-2-2-140HA05-HP835	30390776
7,80	8	91	53	43	36	SCD120-0780-2-2-140HA05-HP835	30390778
7,90	8	91	53	43	36	SCD120-0790-2-2-140HA05-HP835	30390779
8,00	8	91	53	43	36	SCD120-0800-2-2-140HA05-HP835	30390780
8,10	10	103	61	49	40	SCD120-0810-2-2-140HA05-HP835	30390781
8,20	10	103	61	49	40	SCD120-0820-2-2-140HA05-HP835	30390782
8,50	10	103	61	49	40	SCD120-0850-2-2-140HA05-HP835	30390785
8,60	10	103	61	49	40	SCD120-0860-2-2-140HA05-HP835	30390786
8,70	10	103	61	49	40	SCD120-0870-2-2-140HA05-HP835	30390787
8,80	10	103	61	49	40	SCD120-0880-2-2-140HA05-HP835	30390788
9,00	10	103	61	49	40	SCD120-0900-2-2-140HA05-HP835	30390790
9,20	10	103	61	49	40	SCD120-0920-2-2-140HA05-HP835	30390792
9,30	10	103	61	49	40	SCD120-0930-2-2-140HA05-HP835	30390793
9,40	10	103	61	49	40	SCD120-0940-2-2-140HA05-HP835	30390794
9,50	10	103	61	49	40	SCD120-0950-2-2-140HA05-HP835	30390795
10,00	10	103	61	49	40	SCD120-1000-2-2-140HA05-HP835	30390800
10,20	12	118	71	56	45	SCD120-1020-2-2-140HA05-HP835	30390802
10,30	12	118	71	56	45	SCD120-1030-2-2-140HA05-HP835	30390803
10,50	12	118	71	56	45	SCD120-1050-2-2-140HA05-HP835	30390805
10,80	12	118	71	56	45	SCD120-1080-2-2-140HA05-HP835	30390808
11,00	12	118	71	56	45	SCD120-1100-2-2-140HA05-HP835	30390810
11,70	12	118	71	56	45	SCD120-1170-2-2-140HA05-HP835	30390817
11,80	12	118	71	56	45	SCD120-1180-2-2-140HA05-HP835	30390818
12,00	12	118	71	56	45	SCD120-1200-2-2-140HA05-HP835	30390820
12,50	14	124	77	60	45	SCD120-1250-2-2-140HA05-HP835	30390821
13,00	14	124	77	60	45	SCD120-1300-2-2-140HA05-HP835	30390822
16,00	16	133	83	63	48	SCD120-1600-2-2-140HA05-HP835	30390828
16,50	18	143	93	71	48	SCD120-1650-2-2-140HA05-HP835	30445987

Możliwość konfiguracji parametrów



Średnica:

możliwość wyboru średnicy w krokach co 0,01 mm



Typ chwytu:

Typ chwytu: HB | HE

Specyfikacja:

SCD120-[średnica]-2-2-140[typ chwytu]05-HP835

Wymiary typoszeregu z możliwością konfiguracji parametrów

d ₁ min.	d ₁ max.	d ₂ h6	l ₁	l ₂	l ₃	l ₄
3,00	3,70	6	66	66	23	36
3,71	4,70	6	74	74	29	36
4,71	6,00	6	82	44	35	36
6,01	8,00	8	91	53	43	36
8,01	10,00	10	103	61	49	40
10,01	12,00	12	118	71	56	45
12,01	14,00	14	124	77	60	45
14,01	16,00	16	133	83	63	48
16,01	18,00	18	143	93	71	48
18,01	20,00	20	153	101	77	50

Przykład:

SCD120-0431-2-2-140HE05-HP835

Typ chwytu HE

Średnica narzędzia d₁ = 4,31 mm

Wymiary podano w mm.

Zalecane parametry skrawania - patrz koniec rozdziału.

Wersje specjalne i inne powłoki wg zapytania ofertowego.

MEGA-Drill-Inox

Wiertła spiralne z węgla spiekane
SCD121 (5xD), wewnętrzne doprowadzenie chłodziwa

Wersja:
Średnica wiertła: 2,80 – 20,00 mm
Tolerancja otworu: ≥ IT 9
Materiał skrawający: HP835
Liczba ostrzy: 2
Liczba tyselek: 2
Kąt wierzchołkowy: 140°
Kąt spirali: 30°

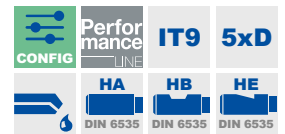
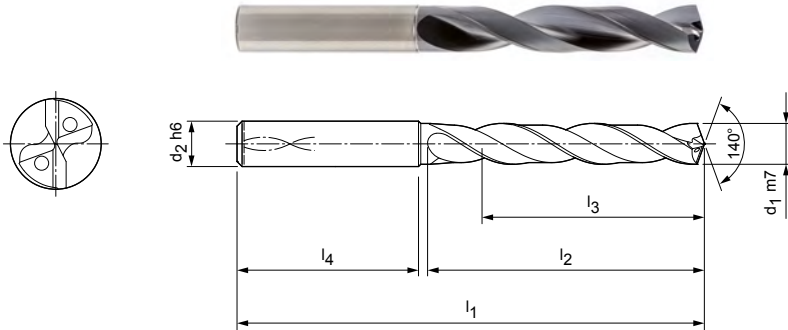

Magazynowa seria preferowana z typem chwytu HA

Wymiary						Typ chwytu HA	
d ₁ m7	d ₂ h6	l ₁	l ₂	l ₃	l ₄	Specyfikacja	Nr materiałowy
2,80	6	66	28	23	36	SCD121-0280-2-2-140HA05-HP835	30453905
3,00	6	66	28	23	36	SCD121-0300-2-2-140HA05-HP835	30390951
3,10	6	66	28	23	36	SCD121-0310-2-2-140HA05-HP835	30390952
3,15	6	66	28	23	36	SCD121-0315-2-2-140HA05-HP835	30430429
3,20	6	66	28	23	36	SCD121-0320-2-2-140HA05-HP835	30390953
3,22	6	66	28	23	36	SCD121-0322-2-2-140HA05-HP835	30453650
3,25	6	66	28	23	36	SCD121-0325-2-2-140HA05-HP835	30453651
3,30	6	66	28	23	36	SCD121-0330-2-2-140HA05-HP835	30390954
3,40	6	66	28	23	36	SCD121-0340-2-2-140HA05-HP835	30390955
3,50	6	66	28	23	36	SCD121-0350-2-2-140HA05-HP835	30390956
3,60	6	66	28	23	36	SCD121-0360-2-2-140HA05-HP835	30390957
3,70*	6	66	28	23	36	SCD121-0370-2-2-140HA05-HP835	30390958
3,80	6	74	36	29	36	SCD121-0380-2-2-140HA05-HP835	30390959
3,90	6	74	36	29	36	SCD121-0390-2-2-140HA05-HP835	30390960
4,00	6	74	36	29	36	SCD121-0400-2-2-140HA05-HP835	30390961
4,10	6	74	36	29	36	SCD121-0410-2-2-140HA05-HP835	30390962
4,15	6	74	36	29	36	SCD121-0415-2-2-140HA05-HP835	30454007
4,20	6	74	36	29	36	SCD121-0420-2-2-140HA05-HP835	30390963
4,30	6	74	36	29	36	SCD121-0430-2-2-140HA05-HP835	30390964
4,40	6	74	36	29	36	SCD121-0440-2-2-140HA05-HP835	30390965
4,45	6	74	36	29	36	SCD121-0445-2-2-140HA05-HP835	30453654
4,50	6	74	36	29	36	SCD121-0450-2-2-140HA05-HP835	30390966
4,60	6	74	36	29	36	SCD121-0460-2-2-140HA05-HP835	30390967
4,65*	6	74	36	29	36	SCD121-0465-2-2-140HA05-HP835	30453655
4,70	6	74	36	29	36	SCD121-0470-2-2-140HA05-HP835	30390968
4,80	6	82	44	35	36	SCD121-0480-2-2-140HA05-HP835	30390969
4,90	6	82	44	35	36	SCD121-0490-2-2-140HA05-HP835	30390970
5,00	6	82	44	35	36	SCD121-0500-2-2-140HA05-HP835	30390971
5,10	6	82	44	35	36	SCD121-0510-2-2-140HA05-HP835	30390972
5,20	6	82	44	35	36	SCD121-0520-2-2-140HA05-HP835	30390973
5,30	6	82	44	35	36	SCD121-0530-2-2-140HA05-HP835	30390974
5,40	6	82	44	35	36	SCD121-0540-2-2-140HA05-HP835	30390975
5,50	6	82	44	35	36	SCD121-0550-2-2-140HA05-HP835	30390976
5,60	6	82	44	35	36	SCD121-0560-2-2-140HA05-HP835	30390977
5,70	6	82	44	35	36	SCD121-0570-2-2-140HA05-HP835	30390978

MEGA-Drill-Inox | Wiertła spiralne z węgla spiekanego SCD121 (5xD), wewnętrzne doprowadzenie chłodziwa

Wymiary						Typ chwytu HA	
d ₁ m7	d ₂ h6	l ₁	l ₂	l ₃	l ₄	Specyfikacja	Nr materiałowy
5,80	6	82	44	35	36	SCD121-0580-2-2-140HA05-HP835	30390979
5,90	6	82	44	35	36	SCD121-0590-2-2-140HA05-HP835	30390980
5,95	6	82	44	35	36	SCD121-0595-2-2-140HA05-HP835	30453657
6,00	6	82	44	35	36	SCD121-0600-2-2-140HA05-HP835	30390981
6,10	8	91	53	43	36	SCD121-0610-2-2-140HA05-HP835	30390982
6,20	8	91	53	43	36	SCD121-0620-2-2-140HA05-HP835	30390983
6,30	8	91	53	43	36	SCD121-0630-2-2-140HA05-HP835	30390984
6,40	8	91	53	43	36	SCD121-0640-2-2-140HA05-HP835	30390985
6,50	8	91	53	43	36	SCD121-0650-2-2-140HA05-HP835	30390986
6,60	8	91	53	43	36	SCD121-0660-2-2-140HA05-HP835	30390987
6,70	8	91	53	43	36	SCD121-0670-2-2-140HA05-HP835	30390988
6,80	8	91	53	43	36	SCD121-0680-2-2-140HA05-HP835	30390989
6,90	8	91	53	43	36	SCD121-0690-2-2-140HA05-HP835	30390990
7,00	8	91	53	43	36	SCD121-0700-2-2-140HA05-HP835	30390991
7,10	8	91	53	43	36	SCD121-0710-2-2-140HA05-HP835	30390992
7,20	8	91	53	43	36	SCD121-0720-2-2-140HA05-HP835	30390993
7,30	8	91	53	43	36	SCD121-0730-2-2-140HA05-HP835	30390994
7,40	8	91	53	43	36	SCD121-0740-2-2-140HA05-HP835	30390995
7,45*	8	91	53	43	36	SCD121-0745-2-2-140HA05-HP835	30453658
7,50	8	91	53	43	36	SCD121-0750-2-2-140HA05-HP835	30390996
7,60	8	91	53	43	36	SCD121-0760-2-2-140HA05-HP835	30390997
7,70	8	91	53	43	36	SCD121-0770-2-2-140HA05-HP835	30390998
7,80	8	91	53	43	36	SCD121-0780-2-2-140HA05-HP835	30390999
8,00	8	91	53	43	36	SCD121-0800-2-2-140HA05-HP835	30391001
8,10	10	103	61	49	40	SCD121-0810-2-2-140HA05-HP835	30391002
8,20	10	103	61	49	40	SCD121-0820-2-2-140HA05-HP835	30391003
8,30	10	103	61	49	40	SCD121-0830-2-2-140HA05-HP835	30391004
8,50	10	103	61	49	40	SCD121-0850-2-2-140HA05-HP835	30391006
8,60	10	103	61	49	40	SCD121-0860-2-2-140HA05-HP835	30391007
8,70	10	103	61	49	40	SCD121-0870-2-2-140HA05-HP835	30391008
8,80	10	103	61	49	40	SCD121-0880-2-2-140HA05-HP835	30391009
8,90	10	103	61	49	40	SCD121-0890-2-2-140HA05-HP835	30391010
9,00	10	103	61	49	40	SCD121-0900-2-2-140HA05-HP835	30391011
9,10	10	103	61	49	40	SCD121-0910-2-2-140HA05-HP835	30391012
9,35	10	103	61	49	40	SCD121-0935-2-2-140HA05-HP835	30450706
9,40	10	103	61	49	40	SCD121-0940-2-2-140HA05-HP835	30391015
9,45	10	103	61	49	40	SCD121-0945-2-2-140HA05-HP835	30453660
9,50	10	103	61	49	40	SCD121-0950-2-2-140HA05-HP835	30391016
9,80	10	103	61	49	40	SCD121-0980-2-2-140HA05-HP835	30391019
9,90	10	103	61	49	40	SCD121-0990-2-2-140HA05-HP835	30391020
10,00	10	103	61	49	40	SCD121-1000-2-2-140HA05-HP835	30391021
10,20	12	118	71	56	45	SCD121-1020-2-2-140HA05-HP835	30391023
10,30	12	118	71	56	45	SCD121-1030-2-2-140HA05-HP835	30391024
10,50	12	118	71	56	45	SCD121-1050-2-2-140HA05-HP835	30391026
10,55	12	118	71	56	45	SCD121-1055-2-2-140HA05-HP835	30453661
10,80	12	118	71	56	45	SCD121-1080-2-2-140HA05-HP835	30391029
11,00	12	118	71	56	45	SCD121-1100-2-2-140HA05-HP835	30391031
11,20*	12	118	71	56	45	SCD121-1120-2-2-140HA05-HP835	30391033
11,25	12	118	71	56	45	SCD121-1125-2-2-140HA05-HP835	30453662
11,30	12	118	71	56	45	SCD121-1130-2-2-140HA05-HP835	30391034
11,50	12	118	71	56	45	SCD121-1150-2-2-140HA05-HP835	30391036
11,70	12	118	71	56	45	SCD121-1170-2-2-140HA05-HP835	30391038
11,80	12	118	71	56	45	SCD121-1180-2-2-140HA05-HP835	30391039
12,00	12	118	71	56	45	SCD121-1200-2-2-140HA05-HP835	30391041
12,50	14	124	77	60	45	SCD121-1250-2-2-140HA05-HP835	30391042
13,00	14	124	77	60	45	SCD121-1300-2-2-140HA05-HP835	30391044
13,50	14	124	77	60	45	SCD121-1350-2-2-140HA05-HP835	30391045

MEGA-Drill-Inox | Wiertła spiralne z węgla spiekane SCD121 (5xD), wewnętrzne doprowadzenie chłodziwa

Wymiary						Typ chwytu HA	
d ₁ m7	d ₂ h6	l ₁	l ₂	l ₃	l ₄	Specyfikacja	Nr materiałowy
13,80	14	124	77	60	45	SCD121-1380-2-2-140HA05-HP835	30391046
14,00	14	124	77	60	45	SCD121-1400-2-2-140HA05-HP835	30391047
15,00	16	133	83	63	48	SCD121-1500-2-2-140HA05-HP835	30391050
16,00	16	133	83	63	48	SCD121-1600-2-2-140HA05-HP835	30391053
16,50	18	143	93	71	48	SCD121-1650-2-2-140HA05-HP835	30391054
17,00	18	143	93	71	48	SCD121-1700-2-2-140HA05-HP835	30391056
18,00	18	143	93	71	48	SCD121-1800-2-2-140HA05-HP835	30391059
20,00	20	153	101	77	50	SCD121-2000-2-2-140HA05-HP835	30391065

Możliwość konfiguracji parametrów



Średnica:
możliwość wyboru średnicy w krokach
co 0,01 mm





Typ chwytu:
Typ chwytu: HB | HE

Specyfikacja:
SCD121-[średnica]-2-2-140[typ chwytu]05-HP835

Wymiary typoszeregu z możliwością konfiguracji parametrów

d ₁ min.	d ₁ max.	d ₂ h6	l ₁	l ₂	l ₃	l ₄
3,71	4,70	6	74	36	29	36
4,71	6,00	6	82	44	35	36
6,01	8,00	8	91	53	43	36
8,01	10,00	10	103	61	49	40
10,01	12,00	12	118	71	56	45
12,01	14,00	14	124	77	60	45
14,01	16,00	16	133	83	63	45
16,01	18,00	18	143	93	71	48
18,01	20,00	20	153	101	77	50

Przykład:

SCD121-0431-2-2-140HE05-HP835

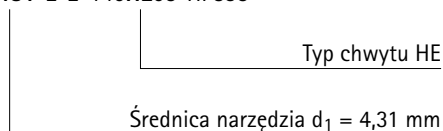

Wymiary podano w mm.

* Nadaje się w szczególności do wiercenia otworów pod gwinty wykonywanych gniotownikami.

Zalecane parametry skrawania – patrz koniec rozdziału.

Wersje specjalne i inne powłoki wg zapytania ofertowego.

MEGA-Drill-Inox

Wiertła spiralne z węgla spiekane
SCD121 (8xD), wewnętrzne doprowadzenie chłodziwa

Wersja:

Średnica wiertła:	3,00 – 20,00 mm
Tolerancja otworu:	≥ IT 9
Materiał skrawający:	HP835
Liczba ostrzy:	2
Liczba łysinek:	2
Kąt wierzchołkowy:	140°
Kąt spirali:	30°

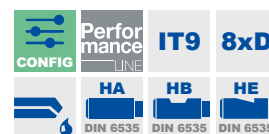
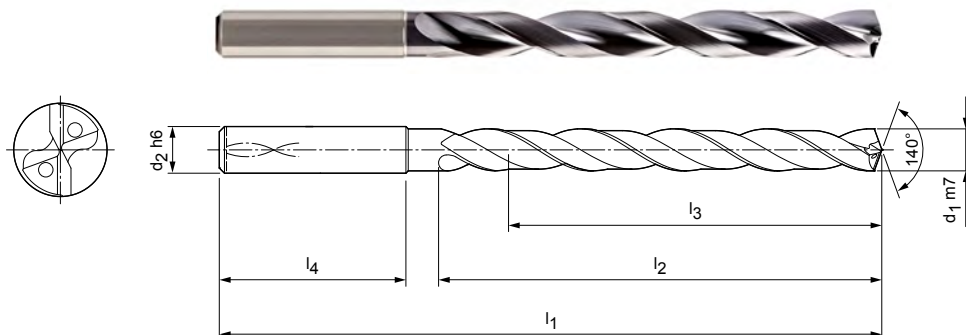

Magazynowa seria preferowana z typem chwytu HA

Wymiary						Typ chwytu HA	
d ₁ m7	d ₂ h6	l ₁	l ₂	l ₃	l ₄	Specyfikacja	Nr materiałowy
3,00	6	72	34	29	36	SCD121-0300-2-2-140HA08-HP835	30391171
3,20	6	72	34	29	36	SCD121-0320-2-2-140HA08-HP835	30391173
3,30	6	72	34	29	36	SCD121-0330-2-2-140HA08-HP835	30391174
3,40	6	72	34	29	36	SCD121-0340-2-2-140HA08-HP835	30391175
3,50	6	72	34	29	36	SCD121-0350-2-2-140HA08-HP835	30391176
3,70	6	72	34	29	36	SCD121-0370-2-2-140HA08-HP835	30391178
3,80	6	81	43	36	36	SCD121-0380-2-2-140HA08-HP835	30391179
3,90	6	81	43	36	36	SCD121-0390-2-2-140HA08-HP835	30391180
4,00	6	81	43	36	36	SCD121-0400-2-2-140HA08-HP835	30391181
4,20	6	81	43	36	36	SCD121-0420-2-2-140HA08-HP835	30391183
4,30	6	81	43	36	36	SCD121-0430-2-2-140HA08-HP835	30391184
4,40	6	81	43	36	36	SCD121-0440-2-2-140HA08-HP835	30391185
4,50	6	81	43	36	36	SCD121-0450-2-2-140HA08-HP835	30391186
4,80	6	95	57	48	36	SCD121-0480-2-2-140HA08-HP835	30391189
4,90	6	95	57	48	36	SCD121-0490-2-2-140HA08-HP835	30391190
5,00	6	95	57	48	36	SCD121-0500-2-2-140HA08-HP835	30391191
5,10	6	95	57	48	36	SCD121-0510-2-2-140HA08-HP835	30391192
5,30	6	95	57	48	36	SCD121-0530-2-2-140HA08-HP835	30391194
5,50	6	95	57	48	36	SCD121-0550-2-2-140HA08-HP835	30391196
5,60	6	95	57	48	36	SCD121-0560-2-2-140HA08-HP835	30391197
5,80	6	95	57	48	36	SCD121-0580-2-2-140HA08-HP835	30391199
5,90	6	95	57	48	36	SCD121-0590-2-2-140HA08-HP835	30391200
6,00	6	95	57	48	36	SCD121-0600-2-2-140HA08-HP835	30391201
6,10	8	114	76	64	36	SCD121-0610-2-2-140HA08-HP835	30391202
6,50	8	114	76	64	36	SCD121-0650-2-2-140HA08-HP835	30391206
6,60	8	114	76	64	36	SCD121-0660-2-2-140HA08-HP835	30391207
6,70	8	114	76	64	36	SCD121-0670-2-2-140HA08-HP835	30391208
6,80	8	114	76	64	36	SCD121-0680-2-2-140HA08-HP835	30391209
6,90	8	114	76	64	36	SCD121-0690-2-2-140HA08-HP835	30391210
7,00	8	114	76	64	36	SCD121-0700-2-2-140HA08-HP835	30391212
7,20	8	114	76	64	36	SCD121-0720-2-2-140HA08-HP835	30391214
7,50	8	114	76	64	36	SCD121-0750-2-2-140HA08-HP835	30391217
7,60	8	114	76	64	36	SCD121-0760-2-2-140HA08-HP835	30391218
7,80	8	114	76	64	36	SCD121-0780-2-2-140HA08-HP835	30391220
8,00	8	114	76	64	36	SCD121-0800-2-2-140HA08-HP835	30391222

MEGA-Drill-Inox | Wiertła spiralne z węgla spiekanego SCD121 (8xD), wewnętrzne doprowadzenie chłodziwa

Wymiary						Typ chwytu HA	
d ₁ m7	d ₂ h6	l ₁	l ₂	l ₃	l ₄	Specyfikacja	Nr materiałowy
8,50	10	142	95	80	40	SCD121-0850-2-2-140HA08-HP835	30391227
8,90	10	142	95	80	40	SCD121-0890-2-2-140HA08-HP835	30391231
9,00	10	142	95	80	40	SCD121-0900-2-2-140HA08-HP835	30391232
9,10	10	142	95	80	40	SCD121-0910-2-2-140HA08-HP835	30391233
9,30	10	142	95	80	40	SCD121-0930-2-2-140HA08-HP835	30391235
9,50	10	142	95	80	40	SCD121-0950-2-2-140HA08-HP835	30391237
9,60	10	142	95	80	40	SCD121-0960-2-2-140HA08-HP835	30391238
9,70	10	142	95	80	40	SCD121-0970-2-2-140HA08-HP835	30391239
9,80	10	142	95	80	40	SCD121-0980-2-2-140HA08-HP835	30391240
10,00	10	142	95	80	40	SCD121-1000-2-2-140HA08-HP835	30391242
10,10	12	162	114	96	45	SCD121-1010-2-2-140HA08-HP835	30391243
10,20	12	162	114	96	45	SCD121-1020-2-2-140HA08-HP835	30391244
10,80	12	162	114	96	45	SCD121-1080-2-2-140HA08-HP835	30391250
11,00	12	162	114	96	45	SCD121-1100-2-2-140HA08-HP835	30391252
11,50	12	162	114	96	45	SCD121-1150-2-2-140HA08-HP835	30391257
11,80	12	162	114	96	45	SCD121-1180-2-2-140HA08-HP835	30391260
12,00	12	162	114	96	45	SCD121-1200-2-2-140HA08-HP835	30391262
13,00	14	178	133	112	45	SCD121-1300-2-2-140HA08-HP835	30391265
13,50	14	178	133	112	45	SCD121-1350-2-2-140HA08-HP835	30391266
14,00	14	178	133	112	45	SCD121-1400-2-2-140HA08-HP835	30391268
14,50	16	203	152	128	48	SCD121-1450-2-2-140HA08-HP835	30391269
15,00	16	203	152	128	48	SCD121-1500-2-2-140HA08-HP835	30391271
18,00	18	222	171	144	48	SCD121-1800-2-2-140HA08-HP835	30391280

Możliwość konfiguracji parametrów



Średnica:
możliwość wyboru średnicy w krokach
co 0,01 mm





Typ chwytu:
Typ chwytu: HB | HE

Specyfikacja:
SCD121-[średnica]-2-2-140[typ chwytu]08-HP835

Przykład:

SCD121-0431-2-2-140HE08-HP835

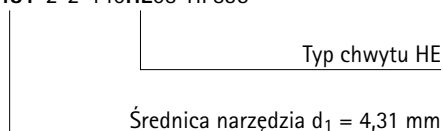

Wymiary typoszeregu z możliwością konfiguracji parametrów

d ₁ min.	d ₁ max.	d ₂ h6	l ₁	l ₂	l ₃	l ₄
3,71	4,70	6	81	43	36	36
4,71	6,00	6	95	57	48	36
6,01	8,00	8	114	76	64	36
8,01	10,00	10	142	95	80	40
10,01	12,00	12	162	114	96	45
12,01	14,00	14	178	133	112	45
14,01	16,00	16	203	152	128	48
16,01	18,00	18	222	171	144	48
18,01	20,00	20	243	190	160	50
16,01	18,00	18	123	73	51	48
18,01	20,00	20	131	79	55	50

Wymiary podano w mm.

Zalecane parametry skrawania - patrz koniec rozdziału.

Wersje specjalne i inne powłoki wg zapytania ofertowego.

MEGA-Speed-Drill-Inox

Wiertła spiralne z węglika spiekane

SCD411 (5xD), wewnętrzne doprowadzenie chłodziwa

Wersja:

Średnica wiertła:	3,00 – 20,00 mm
Tolerancja otworu:	≥ IT 9
Materiał skrawający:	HP374
Liczba ostrzy:	2
Liczba tyśinek:	3
Kąt wierzchołkowy:	135°
Kąt spirali:	30°

Zastosowanie:

Do obróbki z dużą prędkością.

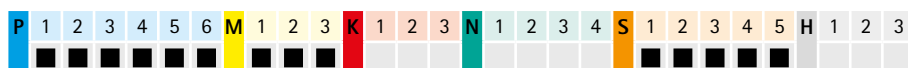
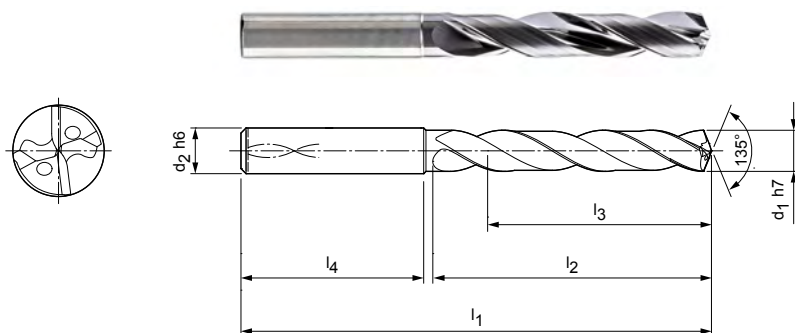

Magazynowa seria preferowana z typem chwytu HA

Wymiary						Typ chwytu HA	
d ₁ h7	d ₂ h6	l ₁	l ₂	l ₃	l ₄	Specyfikacja	Nr materiałowy
3,00	6	66	28	23	36	SCD411-0300-2-3-135HA05-HP374	30488182
3,10	6	66	28	23	36	SCD411-0310-2-3-135HA05-HP374	30488183
3,20	6	66	28	23	36	SCD411-0320-2-3-135HA05-HP374	30488184
3,30	6	66	28	23	36	SCD411-0330-2-3-135HA05-HP374	30488185
3,40	6	66	28	23	36	SCD411-0340-2-3-135HA05-HP374	30488186
3,50	6	66	28	23	36	SCD411-0350-2-3-135HA05-HP374	30488187
3,70	6	66	28	23	36	SCD411-0370-2-3-135HA05-HP374	30488189
3,80	6	74	36	29	36	SCD411-0380-2-3-135HA05-HP374	30488190
4,00	6	74	36	29	36	SCD411-0400-2-3-135HA05-HP374	30488192
4,10	6	74	36	29	36	SCD411-0410-2-3-135HA05-HP374	30488193
4,20	6	74	36	29	36	SCD411-0420-2-3-135HA05-HP374	30488194
4,30	6	74	36	29	36	SCD411-0430-2-3-135HA05-HP374	30488195
4,50	6	74	36	29	36	SCD411-0450-2-3-135HA05-HP374	30488197
4,65	6	74	36	29	36	SCD411-0465-2-3-135HA05-HP374	30488199
4,70	6	74	36	29	36	SCD411-0470-2-3-135HA05-HP374	30488200
4,80	6	82	44	35	36	SCD411-0480-2-3-135HA05-HP374	30488201
5,00	6	82	44	35	36	SCD411-0500-2-3-135HA05-HP374	30488203
5,10	6	82	44	35	36	SCD411-0510-2-3-135HA05-HP374	30488204
5,20	6	82	44	35	36	SCD411-0520-2-3-135HA05-HP374	30488205
5,30	6	82	44	35	36	SCD411-0530-2-3-135HA05-HP374	30488206
5,50	6	82	44	35	36	SCD411-0550-2-3-135HA05-HP374	30488208
5,55	6	82	44	35	36	SCD411-0555-2-3-135HA05-HP374	30488209
5,60	6	82	44	35	36	SCD411-0560-2-3-135HA05-HP374	30488210
5,80	6	82	44	35	36	SCD411-0580-2-3-135HA05-HP374	30488212
5,90	6	82	44	35	36	SCD411-0590-2-3-135HA05-HP374	30488213
6,00	6	82	44	35	36	SCD411-0600-2-3-135HA05-HP374	30488214
6,10	8	91	53	43	36	SCD411-0610-2-3-135HA05-HP374	30488215
6,30	8	91	53	43	36	SCD411-0630-2-3-135HA05-HP374	30488217
6,50	8	91	53	43	36	SCD411-0650-2-3-135HA05-HP374	30488219
6,60	8	91	53	43	36	SCD411-0660-2-3-135HA05-HP374	30488220
6,80	8	91	53	43	36	SCD411-0680-2-3-135HA05-HP374	30488222
6,90	8	91	53	43	36	SCD411-0690-2-3-135HA05-HP374	30488223
7,00	8	91	53	43	36	SCD411-0700-2-3-135HA05-HP374	30488224
7,30	8	91	53	43	36	SCD411-0730-2-3-135HA05-HP374	30488227
7,40	8	91	53	43	36	SCD411-0740-2-3-135HA05-HP374	30488228

MEGA-Speed-Drill-Inox | Wiertła spiralne z węgla spiekane SCD411 (5xD), wewnętrzne doprowadzenie chłodziwa

Wymiary						Typ chwytu HA	
d ₁ h7	d ₂ h6	l ₁	l ₂	l ₃	l ₄	Specyfikacja	Nr materiałowy
7,50	8	91	53	43	36	SCD411-0750-2-3-135HA05-HP374	30488229
7,60	8	91	53	43	36	SCD411-0760-2-3-135HA05-HP374	30488230
7,80	8	91	53	43	36	SCD411-0780-2-3-135HA05-HP374	30488232
8,00	8	91	53	43	36	SCD411-0800-2-3-135HA05-HP374	30488234
8,30	10	103	61	49	40	SCD411-0830-2-3-135HA05-HP374	30488237
8,50	10	103	61	49	40	SCD411-0850-2-3-135HA05-HP374	30488239
8,60	10	103	61	49	40	SCD411-0860-2-3-135HA05-HP374	30488240
8,70	10	103	61	49	40	SCD411-0870-2-3-135HA05-HP374	30488241
8,80	10	103	61	49	40	SCD411-0880-2-3-135HA05-HP374	30488242
8,90	10	103	61	49	40	SCD411-0890-2-3-135HA05-HP374	30488243
9,00	10	103	61	49	40	SCD411-0900-2-3-135HA05-HP374	30488244
9,20	10	103	61	49	40	SCD411-0920-2-3-135HA05-HP374	30488246
9,50	10	103	61	49	40	SCD411-0950-2-3-135HA05-HP374	30488249
9,70	10	103	61	49	40	SCD411-0970-2-3-135HA05-HP374	30488251
9,80	10	103	61	49	40	SCD411-0980-2-3-135HA05-HP374	30488252
9,90	10	103	61	49	40	SCD411-0990-2-3-135HA05-HP374	30488253
10,00	10	103	61	49	40	SCD411-1000-2-3-135HA05-HP374	30488254
10,20	12	118	71	56	45	SCD411-1020-2-3-135HA05-HP374	30488256
10,30	12	118	71	56	45	SCD411-1030-2-3-135HA05-HP374	30488257
10,50	12	118	71	56	45	SCD411-1050-2-3-135HA05-HP374	30488259
10,80	12	118	71	56	45	SCD411-1080-2-3-135HA05-HP374	30488262
11,00	12	118	71	56	45	SCD411-1100-2-3-135HA05-HP374	30488264
11,50	12	118	71	56	45	SCD411-1150-2-3-135HA05-HP374	30488269
11,80	12	118	71	56	45	SCD411-1180-2-3-135HA05-HP374	30488272
12,00	12	118	71	56	45	SCD411-1200-2-3-135HA05-HP374	30488274
12,20	14	124	77	60	45	SCD411-1220-2-3-135HA05-HP374	31307527
12,50	14	124	77	60	45	SCD411-1250-2-3-135HA05-HP374	30488275
12,80	14	124	77	60	45	SCD411-1280-2-3-135HA05-HP374	30488276
13,00	14	124	77	60	45	SCD411-1300-2-3-135HA05-HP374	30488277
13,50	14	124	77	60	45	SCD411-1350-2-3-135HA05-HP374	30488278
14,00	14	124	77	60	45	SCD411-1400-2-3-135HA05-HP374	30488280
14,20	16	133	83	63	48	SCD411-1420-2-3-135HA05-HP374	30661538
14,50	16	133	83	71	48	SCD411-1450-2-3-135HA05-HP374	30488281
15,00	16	133	83	71	48	SCD411-1500-2-3-135HA05-HP374	30488283
16,00	16	133	83	71	48	SCD411-1600-2-3-135HA05-HP374	30488286
17,00	18	143	93	71	48	SCD411-1700-2-3-135HA05-HP374	30488289
17,50	18	143	93	71	48	SCD411-1750-2-3-135HA05-HP374	30488290
18,00	18	143	93	71	48	SCD411-1800-2-3-135HA05-HP374	30488292
18,50	20	153	101	77	50	SCD411-1850-2-3-135HA05-HP374	30488293
20,00	20	153	101	77	50	SCD411-2000-2-3-135HA05-HP374	30488298

Ciąg dalszy na następnej stronie.

MEGA-Speed-Drill-Inox | Wiertła spiralne z węgla spiekane SCD411 (5xD), wewnętrzne doprowadzenie chłodziwa

Możliwość konfiguracji parametrów



Średnica:
możliwość wyboru średnicy w krokach
co 0,01 mm



Typ chwytu:
Typ chwytu: HB | HE

Specyfikacja:

SCD411-[średnica]-2-3-135[typ chwytu]05-HP374

Wymiary typoszeregu z możliwością konfiguracji parametrów

d ₁ min.	d ₁ max.	d ₂ h6	l ₁	l ₂	l ₃	l ₄
3,00	3,70	6	66	28	23	36
3,71	4,70	6	74	36	29	36
4,71	6,00	6	82	44	35	36
6,01	8,00	8	91	53	43	36
8,01	10,00	10	103	61	49	40
10,01	12,00	12	118	71	56	45
12,01	14,00	14	124	77	60	45
14,01	16,00	16	133	83	63	48
16,01	18,00	18	143	93	71	48
18,01	20,00	20	153	101	77	50

Przykład:

SCD411-0431-2-3-140HE05-HP374

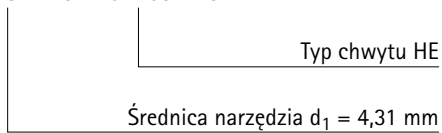

MEGA-Speed-Drill-Inox

Wiertła spiralne z węgla spiekane
SCD411 (8xD), wewnętrzne doprowadzenie chłodziwa

Wersja:

Średnica wiertła: 3,00 – 20,00 mm
Tolerancja otworu: \geq IT 9
Materiał skrawający: HP374
Liczba ostrzy: 2
Liczba tyselek: 3
Kąt wierzchołkowy: 135°
Kąt spirali: 30°

Zastosowanie:

Do obróbki z dużymi prędkościami.

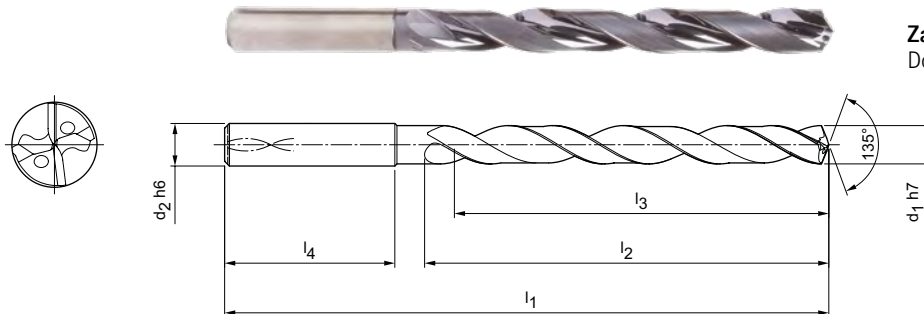

Magazynowa seria preferowana z typem chwytu HA

Wymiary						Typ chwytu HA	
d ₁ h7	d ₂ h6	l ₁	l ₂	l ₃	l ₄	Specyfikacja	Nr materiałowy
3,00	6	72	34	29	36	SCD411-0300-2-3-135HA08-HP374	31159372
3,20	6	72	34	29	36	SCD411-0320-2-3-135HA08-HP374	31159374
3,30	6	72	34	29	36	SCD411-0330-2-3-135HA08-HP374	31159375
3,40	6	72	34	29	36	SCD411-0340-2-3-135HA08-HP374	31159376
3,50	6	72	34	29	36	SCD411-0350-2-3-135HA08-HP374	31159377
3,70	6	72	34	29	36	SCD411-0370-2-3-135HA08-HP374	31159379
3,90	6	81	43	36	36	SCD411-0390-2-3-135HA08-HP374	31159391
4,00	6	81	43	36	36	SCD411-0400-2-3-135HA08-HP374	31159392
4,10	6	81	43	36	36	SCD411-0410-2-3-135HA08-HP374	31159393
4,20	6	81	43	36	36	SCD411-0420-2-3-135HA08-HP374	31159394
4,30	6	81	43	36	36	SCD411-0430-2-3-135HA08-HP374	31159395
4,50	6	81	43	36	36	SCD411-0450-2-3-135HA08-HP374	31159397
4,60	6	81	43	36	36	SCD411-0460-2-3-135HA08-HP374	31159398
4,80	6	95	57	48	36	SCD411-0480-2-3-135HA08-HP374	31159401
5,00	6	95	57	48	36	SCD411-0500-2-3-135HA08-HP374	31159403
5,10	6	95	57	48	36	SCD411-0510-2-3-135HA08-HP374	31159404
5,20	6	95	57	48	36	SCD411-0520-2-3-135HA08-HP374	31159405
5,40	6	95	57	48	36	SCD411-0540-2-3-135HA08-HP374	31159407
5,50	6	95	57	48	36	SCD411-0550-2-3-135HA08-HP374	31159408
5,80	6	95	57	48	36	SCD411-0580-2-3-135HA08-HP374	31159412
6,00	6	95	57	48	36	SCD411-0600-2-3-135HA08-HP374	31159414
6,10	8	114	76	64	36	SCD411-0610-2-3-135HA08-HP374	31159415
6,50	8	114	76	64	36	SCD411-0650-2-3-135HA08-HP374	31159419
6,80	8	114	76	64	36	SCD411-0680-2-3-135HA08-HP374	31159422
7,00	8	114	76	64	36	SCD411-0700-2-3-135HA08-HP374	31159424
7,50	8	114	76	64	36	SCD411-0750-2-3-135HA08-HP374	31159429
7,80	8	114	76	64	36	SCD411-0780-2-3-135HA08-HP374	31159432
8,00	8	114	76	64	36	SCD411-0800-2-3-135HA08-HP374	31159434
8,50	10	142	95	80	40	SCD411-0850-2-3-135HA08-HP374	31159439
9,00	10	142	95	80	40	SCD411-0900-2-3-135HA08-HP374	31159444
9,30	10	142	95	80	40	SCD411-0930-2-3-135HA08-HP374	31159447
9,50	10	142	95	80	40	SCD411-0950-2-3-135HA08-HP374	31159449
9,80	10	142	95	80	40	SCD411-0980-2-3-135HA08-HP374	31159452
10,00	10	142	95	80	40	SCD411-1000-2-3-135HA08-HP374	31159454
10,20	12	162	114	96	45	SCD411-1020-2-3-135HA08-HP374	31159456

MEGA-Speed-Drill-Inox | Wiertła spiralne z węgliku spiekane SCD411 (8xD), wewnętrzne doprowadzenie chłodziwa

Wymiary						Typ chwytu HA	
d ₁ h7	d ₂ h6	l ₁	l ₂	l ₃	l ₄	Specyfikacja	Nr materiałowy
10,50	12	162	114	96	45	SCD411-1050-2-3-135HA08-HP374	31159459
11,00	12	162	114	96	45	SCD411-1100-2-3-135HA08-HP374	31159464
11,80	12	162	114	96	45	SCD411-1180-2-3-135HA08-HP374	31159472
12,00	12	162	114	96	45	SCD411-1200-2-3-135HA08-HP374	31159474
12,50	14	178	133	112	45	SCD411-1250-2-3-135HA08-HP374	31159476
13,00	14	178	133	112	45	SCD411-1300-2-3-135HA08-HP374	31159478
13,50	14	178	133	112	45	SCD411-1350-2-3-135HA08-HP374	31159479
14,00	14	178	133	112	45	SCD411-1400-2-3-135HA08-HP374	31159481
15,00	16	203	152	128	48	SCD411-1500-2-3-135HA08-HP374	31159485
16,00	16	203	152	128	48	SCD411-1600-2-3-135HA08-HP374	31159489

Możliwość konfiguracji parametrów



Średnica:
możliwość wyboru średnicy w krokach
co 0,01 mm



Typ chwytu:
Typ chwytu: HB | HE

Specyfikacja:

SCD411-[średnica]-2-3-135[typ chwytu]08-HP374

Przykład:

SCD411-0431-2-3-140HE08-HP374

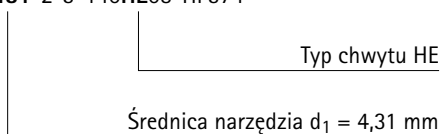

Wymiary typoszeregu z możliwością konfiguracji parametrów

d ₁ min.	d ₁ max.	d ₂ h6	l ₁	l ₂	l ₃	l ₄
3,00	3,70	6	72	34	29	36
3,71	4,70	6	81	43	36	36
4,71	6,00	6	95	57	48	36
6,01	8,00	8	114	76	64	36
8,01	10,00	10	142	95	80	40
10,01	12,00	12	162	114	96	45
12,01	14,00	14	178	133	112	45
14,01	16,00	16	203	152	128	48
16,01	18,00	18	222	171	144	48
18,01	20,00	20	243	190	160	50

Wymiary podano w mm.

Zalecane parametry skrawania - patrz koniec rozdziału.

Wersje specjalne i inne powłoki wg zapytania ofertowego.

MEGA-Speed-Drill-Inox

Wiertła spiralne z węgla spiekane
SCD411 (12xD), wewnętrzne doprowadzenie chłodziwa

Wersja:

Średnica wiertła:	3,00 – 20,00 mm
Tolerancja otworu:	≥ IT 9
Materiał skrawający:	HP374
Liczba ostrzy:	2
Liczba tyśinek:	3
Kąt wierzchołkowy:	135°
Kąt spirali:	30°

Zastosowanie:

Do obróbki z dużymi prędkościami.

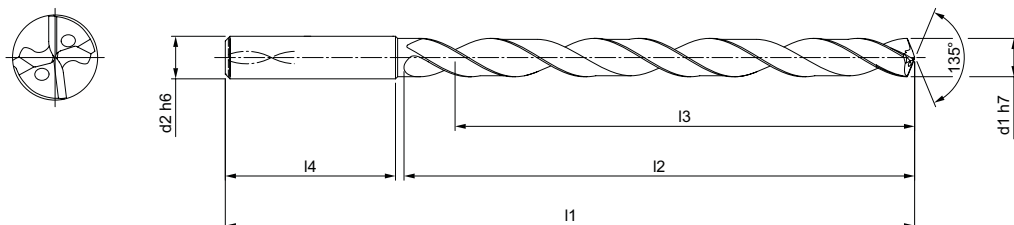

Magazynowa seria preferowana z typem chwytu HA

Wymiary						Typ chwytu HA	
d ₁ h7	d ₂ h6	l ₁	l ₂	l ₃	l ₄	Specyfikacja	Nr materiałowy
3,00	6	92	54	48	36	SCD411-0300-2-3-135HA12-HP374	31132678
3,10	6	92	54	48	36	SCD411-0310-2-3-135HA12-HP374	31132679
3,20	6	92	54	48	36	SCD411-0320-2-3-135HA12-HP374	31132690
3,30	6	92	54	48	36	SCD411-0330-2-3-135HA12-HP374	31132691
3,40	6	92	54	48	36	SCD411-0340-2-3-135HA12-HP374	31132692
3,50	6	92	54	48	36	SCD411-0350-2-3-135HA12-HP374	31132693
3,70	6	92	54	48	36	SCD411-0370-2-3-135HA12-HP374	31132695
4,00	6	102	64	58	36	SCD411-0400-2-3-135HA12-HP374	31132698
4,10	6	102	64	58	36	SCD411-0410-2-3-135HA12-HP374	31132699
4,20	6	102	64	58	36	SCD411-0420-2-3-135HA12-HP374	31132700
4,30	6	102	64	58	36	SCD411-0430-2-3-135HA12-HP374	31132701
4,50	6	102	64	58	36	SCD411-0450-2-3-135HA12-HP374	31132703
4,80	6	116	78	70	36	SCD411-0480-2-3-135HA12-HP374	31132706
5,00	6	116	78	70	36	SCD411-0500-2-3-135HA12-HP374	31132708
5,10	6	116	78	70	36	SCD411-0510-2-3-135HA12-HP374	31132709
5,20	6	116	78	70	36	SCD411-0520-2-3-135HA12-HP374	31132710
5,40	6	116	78	70	36	SCD411-0540-2-3-135HA12-HP374	31132712
5,50	6	116	78	70	36	SCD411-0550-2-3-135HA12-HP374	31132713
5,80	6	116	78	70	36	SCD411-0580-2-3-135HA12-HP374	31132716
6,00	6	116	78	70	36	SCD411-0600-2-3-135HA12-HP374	31132718
6,10	8	146	108	94	36	SCD411-0610-2-3-135HA12-HP374	31132719
6,20	8	146	108	94	36	SCD411-0620-2-3-135HA12-HP374	31132720
6,50	8	146	108	94	36	SCD411-0650-2-3-135HA12-HP374	31132723
6,80	8	146	108	94	36	SCD411-0680-2-3-135HA12-HP374	31132726
7,00	8	146	108	94	36	SCD411-0700-2-3-135HA12-HP374	31132728
7,50	8	146	108	94	36	SCD411-0750-2-3-135HA12-HP374	31132733
7,80	8	146	108	94	36	SCD411-0780-2-3-135HA12-HP374	31132736
8,00	8	146	108	94	36	SCD411-0800-2-3-135HA12-HP374	31132738
8,50	10	162	120	110	40	SCD411-0850-2-3-135HA12-HP374	31132743
9,00	10	162	120	110	40	SCD411-0900-2-3-135HA12-HP374	31132748
9,10	10	162	120	110	40	SCD411-0910-2-3-135HA12-HP374	31132749
9,50	10	162	120	110	40	SCD411-0950-2-3-135HA12-HP374	31132753
9,70	10	162	120	110	40	SCD411-0970-2-3-135HA12-HP374	31132755
9,80	10	162	120	110	40	SCD411-0980-2-3-135HA12-HP374	31132756
10,00	10	162	120	110	40	SCD411-1000-2-3-135HA12-HP374	31132758

MEGA-Speed-Drill-Inox | Wiertła spiralne z węgla spiekane SCD411 (12xD), wewnętrzne doprowadzenie chłodziwa

Wymiary						Typ chwytu HA	
d ₁ h7	d ₂ h6	l ₁	l ₂	l ₃	l ₄	Specyfikacja	Nr materiałowy
10,10	12	204	156	142	45	SCD411-1010-2-3-135HA12-HP374	31132759
10,20	12	204	156	142	45	SCD411-1020-2-3-135HA12-HP374	31132760
10,50	12	204	156	142	45	SCD411-1050-2-3-135HA12-HP374	31132763
11,00	12	204	156	142	45	SCD411-1100-2-3-135HA12-HP374	31132768
11,80	12	204	156	142	45	SCD411-1180-2-3-135HA12-HP374	31132776
12,00	12	204	156	142	45	SCD411-1200-2-3-135HA12-HP374	31132778
12,50	14	230	182	166	45	SCD411-1250-2-3-135HA12-HP374	31132780
12,80	14	230	182	166	45	SCD411-1280-2-3-135HA12-HP374	31132781
13,00	14	230	182	166	45	SCD411-1300-2-3-135HA12-HP374	31132782
13,50	14	230	182	166	45	SCD411-1350-2-3-135HA12-HP374	31132783
14,00	14	230	182	166	45	SCD411-1400-2-3-135HA12-HP374	31132785
15,00	16	260	208	192	48	SCD411-1500-2-3-135HA12-HP374	31132788
16,00	16	260	208	192	48	SCD411-1600-2-3-135HA12-HP374	31132793

Możliwość konfiguracji parametrów



Średnica:
możliwość wyboru średnicy w krokach
co 0,01 mm





Typ chwytu:
Typ chwytu: HB | HE

Specyfikacja:
SCD411-[średnica]-2-3-135[typ chwytu]12-HP374

Wymiary typoszeregu z możliwością konfiguracji parametrów

d ₁ min.	d ₁ max.	d ₂ h6	l ₁	l ₂	l ₃	l ₄
3,00	3,70	6	92	54	48	36
3,71	4,70	6	102	64	58	36
4,71	6,00	6	116	78	70	36
6,01	8,00	8	146	108	94	36
8,01	10,00	10	162	120	110	40
10,01	12,00	12	204	156	142	45
12,01	14,00	14	230	182	166	45
14,01	16,00	16	260	208	192	48
16,01	18,00	18	285	234	216	48
18,01	20,00	20	310	258	240	50

Przykład:

SCD411-0431-2-3-140HE12-HP374

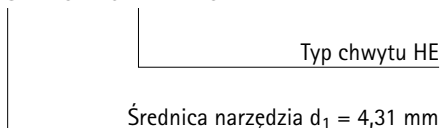

MEGA-Speed-Drill-Iron

Wiertła spiralne z węgliku spiekane
SCD421 (5xD), wewnętrzne doprowadzenie chłodziwa

Wersja:

Średnica wiertła:	3,00 – 20,00 mm
Tolerancja otworu:	≥ IT 9
Materiał skrawający:	HP238
Liczba ostrzy:	2
Liczba tyśinek:	3
Kąt wierzchołkowy:	130°
Kąt spirali:	30°

Zastosowanie:

Do obróbki z dużą prędkością.

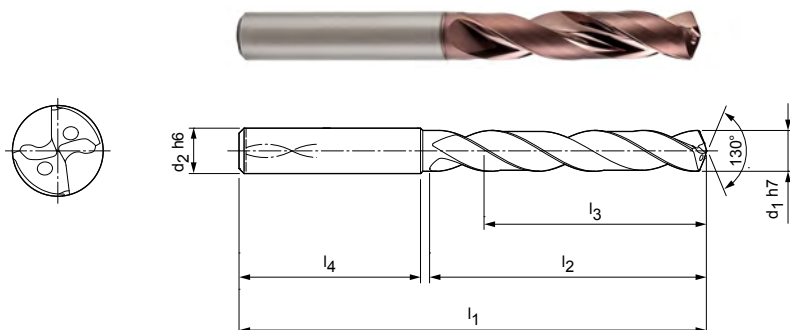

Magazynowa seria preferowana z typem chwytu HA

Wymiary						Typ chwytu HA	
d ₁ h7	d ₂ h6	l ₁	l ₂	l ₃	l ₄	Specyfikacja	Nr materiałowy
5,00	6	82	44	35	36	SCD421-0500-2-3-130HA05-HP238	30488320
5,10	6	82	44	35	36	SCD421-0510-2-3-130HA05-HP238	30488321
6,00	6	82	44	35	36	SCD421-0600-2-3-130HA05-HP238	30488331
6,90	8	91	53	43	36	SCD421-0690-2-3-130HA05-HP238	30488340
7,00	8	91	53	43	36	SCD421-0700-2-3-130HA05-HP238	30488341
7,20	8	91	53	43	36	SCD421-0720-2-3-130HA05-HP238	30488343
8,10	10	103	61	49	40	SCD421-0810-2-3-130HA05-HP238	30488352
8,50	10	103	61	49	40	SCD421-0850-2-3-130HA05-HP238	30488356
9,00	10	103	61	49	40	SCD421-0900-2-3-130HA05-HP238	30488361
14,00	14	124	77	60	45	SCD421-1400-2-3-130HA05-HP238	30488397
17,50	18	143	93	71	48	SCD421-1750-2-3-130HA05-HP238	30488407

Możliwość konfiguracji parametrów

Średnica:
możliwość wyboru średnicy w krokach co 0,01 mm

Typ chwytu:
Typ chwytu: HB | HE

Specyfikacja:
SCD421-[średnica]-2-3-130[typ chwytu]05-HP238

Wymiary typoszeregu z możliwością konfiguracji parametrów

d ₁ min.	d ₁ max.	d ₂ h6	l ₁	l ₂	l ₃	l ₄
3,00	3,70	6	66	28	23	36
3,71	4,79	6	74	36	29	36
4,80	6,00	6	82	44	35	36
6,01	8,00	8	91	53	43	36
8,01	10,00	10	103	61	49	40
10,01	12,00	12	118	71	56	45
12,01	14,00	14	124	77	60	45
14,01	16,00	16	133	83	63	48
16,01	18,00	18	143	93	71	48
18,01	20,00	20	153	101	77	50

Przykład:

SCD421-0431-2-3-130HE05-HP238

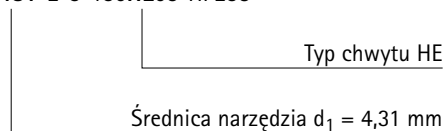

Wymiary podano w mm.

Zalecane parametry skrawania - patrz koniec rozdziału.

Wersje specjalne i inne powłoki wg zapytania ofertowego.

MEGA-Drill-Alu

Wiertła spiralne z węgla spiekane
SCD131 (3xD), wewnętrzne doprowadzenie chłodziwa

Wersja:

Średnica wiertła: 3,00 – 20,00 mm
Tolerancja otworu: \geq IT 9
Materiał skrawający: HU630
Liczba ostrzy: 2
Liczba tyselek: 2
Kąt wierzchołkowy: 140°
Kąt spirali: 30°

Zastosowanie:

Może być stosowane jako wiertło pilotujące do MEGA-Deep-Drill-Alu.

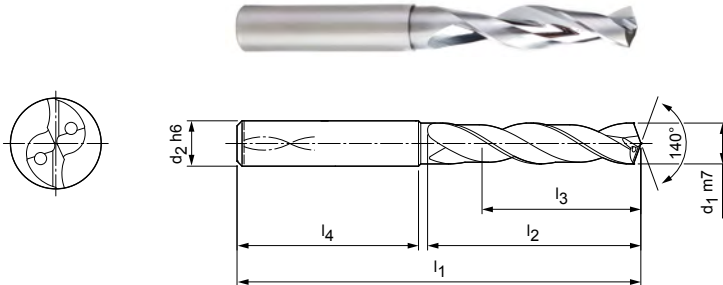

Magazynowa seria preferowana z typem chwytu HA

Wymiary						Typ chwytu HA	
d ₁ m7	d ₂ h6	l ₁	l ₂	l ₃	l ₄	Specyfikacja	Nr materiałowy
6,50	8	79	34	24	36	SCD131-0650-2-2-140HA03-HU630	30394280
6,70	8	79	34	24	36	SCD131-0670-2-2-140HA03-HU630	30446643
7,00	8	79	34	24	36	SCD131-0700-2-2-140HA03-HU630	30391294
10,00	10	89	47	35	40	SCD131-1000-2-2-140HA03-HU630	30391297
11,00	12	102	55	40	45	SCD131-1100-2-2-140HA03-HU630	30391298
12,00	12	102	55	40	45	SCD131-1200-2-2-140HA03-HU630	30391299
13,20	14	107	60	43	45	SCD131-1320-2-2-140HA03-HU630	30694326
13,70	14	107	60	43	45	SCD131-1370-2-2-140HA03-HU630	30694329
16,00	16	115	65	45	48	SCD131-1600-2-2-140HA03-HU630	30391303

Możliwość konfiguracji parametrów

Średnica:
możliwość wyboru średnicy w krokach co 0,01 mm

Typ chwytu:
Typ chwytu: HB | HE

Specyfikacja:
SCD131-[średnica]-2-2-140[typ chwytu]03-HU630

Wymiary typoszeregu z możliwością konfiguracji parametrów

d ₁ min.	d ₁ max.	d ₂ h6	l ₁	l ₂	l ₃	l ₄
3,00	3,50	6	62	20	14	36
3,51	4,50	6	66	24	17	36
4,51	6,00	6	66	28	20	36
6,01	7,97	8	79	34	24	36
7,98	8,00	8	79	41	29	36
8,01	10,00	10	89	47	35	40
10,01	12,00	12	102	55	40	45
12,01	14,00	14	107	60	43	45
14,01	16,00	16	115	65	45	48
16,01	18,00	18	123	73	51	48
18,01	20,00	20	131	79	55	50

Przykład:

SCD131-0431-2-3-140HE03-HU630

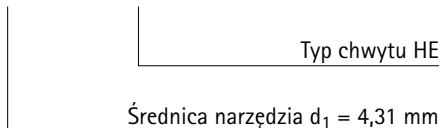

Wymiary podano w mm.

Zalecane parametry skrawania - patrz koniec rozdziału.

Wersje specjalne i inne powłoki wg zapytania ofertowego.

MEGA-Drill-Alu

Wiertła spiralne z węgla spiekane
SCD131 (5xD), wewnętrzne doprowadzenie chłodziwa

Wersja:

Średnica wiertła:	2,80 – 20,00 mm
Tolerancja otworu:	≥ IT 9
Materiał skrawający:	HU630
Liczba ostrzy:	2
Liczba łysinek:	2
Kąt wierzchołkowy:	140°
Kąt spirali:	30°

Zastosowanie:

Może być stosowane jako wiertło pilotujące do MEGA-Deep-Drill-Alu.

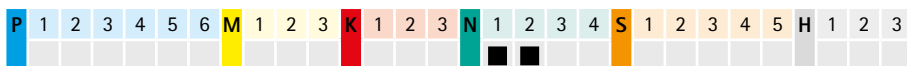
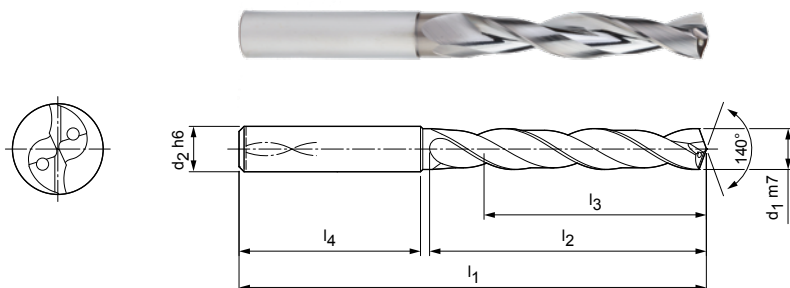

Magazynowa seria preferowana z typem chwytu HA

Wymiary						Typ chwytu HA	
d ₁ m7	d ₂ h6	l ₁	l ₂	l ₃	l ₄	Specyfikacja	Nr materiałowy
3,00	6	66	28	23	36	SCD131-0300-2-2-140HA05-HU630	30391326
3,20	6	66	28	23	36	SCD131-0320-2-2-140HA05-HU630	30391328
3,30	6	66	28	23	36	SCD131-0330-2-2-140HA05-HU630	30391329
3,50	6	66	28	23	36	SCD131-0350-2-2-140HA05-HU630	30391331
3,70*	6	66	28	23	36	SCD131-0370-2-2-140HA05-HU630	30391333
3,90	6	74	36	29	36	SCD131-0390-2-2-140HA05-HU630	30391335
4,00	6	74	36	29	36	SCD131-0400-2-2-140HA05-HU630	30391336
4,10	6	74	36	29	36	SCD131-0410-2-2-140HA05-HU630	30391337
4,20	6	74	36	29	36	SCD131-0420-2-2-140HA05-HU630	30391338
4,30	6	74	36	29	36	SCD131-0430-2-2-140HA05-HU630	30391339
4,50	6	74	36	29	36	SCD131-0450-2-2-140HA05-HU630	30391341
4,60	6	74	36	29	36	SCD131-0460-2-2-140HA05-HU630	30391342
4,70	6	74	36	29	36	SCD131-0470-2-2-140HA05-HU630	30391343
5,00	6	82	44	35	36	SCD131-0500-2-2-140HA05-HU630	30391346
5,10	6	82	44	35	36	SCD131-0510-2-2-140HA05-HU630	30391347
5,20	6	82	44	35	36	SCD131-0520-2-2-140HA05-HU630	30391348
5,50	6	82	44	35	36	SCD131-0550-2-2-140HA05-HU630	30391351
5,60	6	82	44	35	36	SCD131-0560-2-2-140HA05-HU630	30391352
6,00	6	82	44	35	36	SCD131-0600-2-2-140HA05-HU630	30391356
6,10	8	91	53	43	36	SCD131-0610-2-2-140HA05-HU630	30391357
6,20	8	91	53	43	36	SCD131-0620-2-2-140HA05-HU630	30391358
6,30	8	91	53	43	36	SCD131-0630-2-2-140HA05-HU630	30391359
6,40	8	91	53	43	36	SCD131-0640-2-2-140HA05-HU630	30391360
6,50	8	91	53	43	36	SCD131-0650-2-2-140HA05-HU630	30391361
6,60	8	91	53	43	36	SCD131-0660-2-2-140HA05-HU630	30391362
6,80	8	91	53	43	36	SCD131-0680-2-2-140HA05-HU630	30391364
7,00	8	91	53	43	36	SCD131-0700-2-2-140HA05-HU630	30391366
7,40	8	91	53	43	36	SCD131-0740-2-2-140HA05-HU630	30391370
7,50	8	91	53	43	36	SCD131-0750-2-2-140HA05-HU630	30391371
7,60	8	91	53	43	36	SCD131-0760-2-2-140HA05-HU630	30391372
8,00	8	91	53	43	36	SCD131-0800-2-2-140HA05-HU630	30391376
8,40	10	103	61	49	40	SCD131-0840-2-2-140HA05-HU630	30391380
8,50	10	103	61	49	40	SCD131-0850-2-2-140HA05-HU630	30391381
8,73	10	103	61	49	40	SCD131-0873-2-2-140HA05-HU630	30451167
8,90	10	103	61	49	40	SCD131-0890-2-2-140HA05-HU630	30391385

MEGA-Drill-Alu | Wiertła spiralne z węgla spiekane SCD131 (5xD), wewnętrzne doprowadzenie chłodziwa

Wymiary						Typ chwytu HA	
d ₁ m7	d ₂ h6	l ₁	l ₂	l ₃	l ₄	Specyfikacja	Nr materiałowy
9,00	10	103	61	49	40	SCD131-0900-2-2-140HA05-HU630	30391386
9,20	10	103	61	49	40	SCD131-0920-2-2-140HA05-HU630	30391388
9,30*	10	103	61	49	40	SCD131-0930-2-2-140HA05-HU630	30391389
9,50	10	103	61	49	40	SCD131-0950-2-2-140HA05-HU630	30391391
9,60	10	103	61	49	40	SCD131-0960-2-2-140HA05-HU630	30391392
10,00	10	103	61	49	40	SCD131-1000-2-2-140HA05-HU630	30391396
10,20	12	118	71	56	45	SCD131-1020-2-2-140HA05-HU630	30391398
10,50	12	118	71	56	45	SCD131-1050-2-2-140HA05-HU630	30391401
10,80	12	118	71	56	45	SCD131-1080-2-2-140HA05-HU630	30391404
11,00	12	118	71	56	45	SCD131-1100-2-2-140HA05-HU630	30391406
11,50	12	118	71	56	45	SCD131-1150-2-2-140HA05-HU630	30391407
12,00	12	118	71	56	45	SCD131-1200-2-2-140HA05-HU630	30391408
12,50	14	124	77	60	45	SCD131-1250-2-2-140HA05-HU630	30391409
13,50	14	124	77	60	45	SCD131-1350-2-2-140HA05-HU630	30391411
14,00	14	124	77	60	45	SCD131-1400-2-2-140HA05-HU630	30391412
16,00	16	133	83	63	48	SCD131-1600-2-2-140HA05-HU630	30391418
20,00	20	153	101	77	50	SCD131-2000-2-2-140HA05-HU630	30446886

Możliwość konfiguracji parametrów



Średnica:
możliwość wyboru średnicy w krokach
co 0,01 mm





Typ chwytu:
Typ chwytu: HB | HE

Specyfikacja:
SCD131-[średnica]-2-2-140[typ chwytu]05-HU630

Wymiary typoszeregu z możliwością konfiguracji parametrów

d ₁ min.	d ₁ max.	d ₂ h6	l ₁	l ₂	l ₃	l ₄
2,80	3,70	6	66	28	23	36
3,71	4,70	6	74	36	29	36
4,71	6,00	6	82	44	35	36
6,01	8,00	8	91	53	43	36
8,01	10,00	10	103	61	49	40
10,01	12,00	12	118	71	56	45
12,01	14,00	14	124	77	60	45
14,01	16,00	16	133	83	63	48
16,01	18,00	18	143	93	71	48
18,01	20,00	20	153	101	77	50

Przykład:

SCD131-0431-2-2-140HE05-HU630

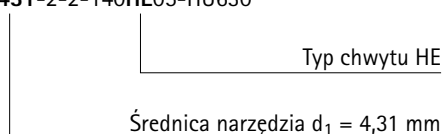

Wymiary podano w mm.

* Nadaje się w szczególności do wiercenia otworów pod gwinty wykonywanych gniotownikami.

Zalecane parametry skrawania - patrz koniec rozdziału.

Wersje specjalne i inne powłoki wg zapytania ofertowego.

MEGA-Drill-Alu

Wiertła spiralne z węgla spiekane
SCD131 (8xD), wewnętrzne doprowadzenie chłodziwa

Wersja:

Średnica wiertła: 3,00 – 20,00 mm
Tolerancja otworu: \geq IT 9
Materiał skrawający: HU630
Liczba ostrzy: 2
Liczba tyśnek: 2
Kąt wierzchołkowy: 140°
Kąt spirali: 30°

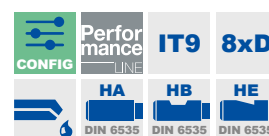
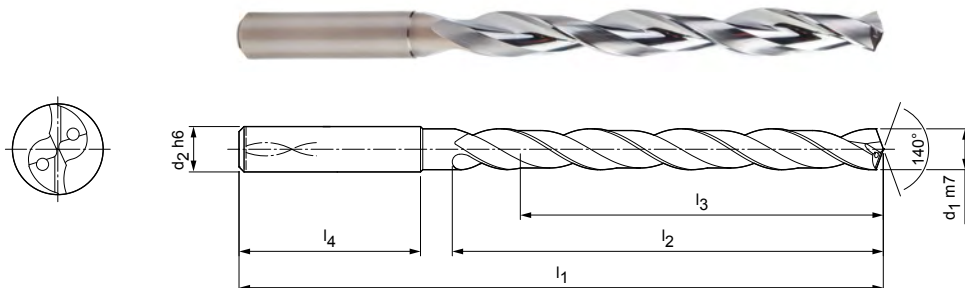

Magazynowa seria preferowana z typem chwytu HA

Wymiary						Typ chwytu HA	
d ₁ m7	d ₂ h6	l ₁	l ₂	l ₃	l ₄	Specyfikacja	Nr materiałowy
3,00	6	72	34	29	36	SCD131-0300-2-2-140HA08-HU630	30391421
3,30	6	72	34	29	36	SCD131-0330-2-2-140HA08-HU630	30391424
3,50	6	72	34	29	36	SCD131-0350-2-2-140HA08-HU630	30391426
3,70	6	72	34	29	36	SCD131-0370-2-2-140HA08-HU630	30391428
4,00	6	81	43	36	36	SCD131-0400-2-2-140HA08-HU630	30391431
4,50	6	81	43	36	36	SCD131-0450-2-2-140HA08-HU630	30391436
5,00	6	95	57	48	36	SCD131-0500-2-2-140HA08-HU630	30391441
5,50	6	95	57	48	36	SCD131-0550-2-2-140HA08-HU630	30391446
6,50	8	114	76	64	36	SCD131-0650-2-2-140HA08-HU630	30391457
6,80	8	114	76	64	36	SCD131-0680-2-2-140HA08-HU630	30391460
7,00	8	114	76	64	36	SCD131-0700-2-2-140HA08-HU630	30391462
8,00	8	114	76	64	36	SCD131-0800-2-2-140HA08-HU630	30391472
9,30	10	142	95	80	40	SCD131-0930-2-2-140HA08-HU630	30391484
11,00	12	162	114	96	45	SCD131-1100-2-2-140HA08-HU630	30391500
12,00	12	162	114	96	45	SCD131-1200-2-2-140HA08-HU630	30391510

Możliwość konfiguracji parametrów

Średnica:
możliwość wyboru średnicy w krokach co 0,01 mm

Typ chwytu:
Typ chwytu: HB | HE

Specyfikacja:
SCD131-[średnica]-2-2-140[typ chwytu]08-HU630

Wymiary typoszeregu z możliwością konfiguracji parametrów

d ₁ min.	d ₁ max.	d ₂ h6	l ₁	l ₂	l ₃	l ₄
3,00	3,70	6	72	34	29	36
3,71	4,70	6	81	43	36	36
4,71	6,00	6	95	57	48	36
6,01	8,00	8	114	76	64	36
8,01	10,00	10	142	95	80	40
10,01	12,00	12	162	114	96	45
12,01	14,00	14	178	133	112	45
14,01	16,00	16	203	152	128	48
16,01	18,00	18	222	171	144	48
18,01	20,00	20	243	190	160	50

Przykład:

SCD131-0431-2-2-140HE08-HU630

Typ chwytu HE

Średnica narzędzia d₁ = 4,31 mm

Wymiary podano w mm.

Zalecane parametry skrawania - patrz koniec rozdziału.

Wersje specjalne i inne powłoki wg zapytania ofertowego.

MEGA-Drill-Alu

Wiertła spiralne z węgla spiekanego
SCD131 (12xD), wewnętrzne doprowadzenie chłodziwa

Wersja:

Średnica wiertła: 3,00 – 20,00 mm
Tolerancja otworu: ≥ IT 9
Materiał skrawający: HU630
Liczba ostrzy: 2
Liczba tyśinek: 2
Kąt wierzchołkowy: 140°
Kąt spirali: 30°

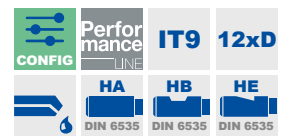
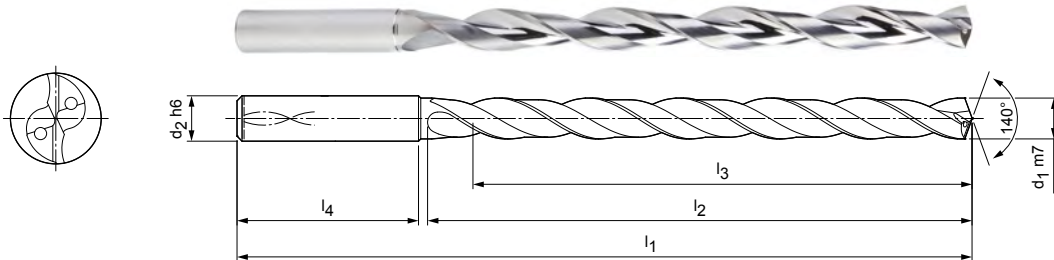

Magazynowa seria preferowana z typem chwytu HA

Wymiary						Typ chwytu HA	
d ₁ m7	d ₂ h6	l ₁	l ₂	l ₃	l ₄	Specyfikacja	Nr materiałowy
3,00	6	92	54	48	36	SCD131-0300-2-2-140HA12-HU630	30391519
3,50	6	92	54	48	36	SCD131-0350-2-2-140HA12-HU630	30391524
4,00	6	102	64	58	36	SCD131-0400-2-2-140HA12-HU630	30391529
4,70	6	102	64	58	36	SCD131-0470-2-2-140HA12-HU630	30391536
5,00	6	116	78	70	36	SCD131-0500-2-2-140HA12-HU630	30391539
5,40	6	116	78	70	36	SCD131-0540-2-2-140HA12-HU630	30391543
5,50	6	116	78	70	36	SCD131-0550-2-2-140HA12-HU630	30391544
5,60	6	116	78	70	36	SCD131-0560-2-2-140HA12-HU630	30391545
6,00	6	116	78	70	36	SCD131-0600-2-2-140HA12-HU630	30391549
6,50	8	146	108	94	36	SCD131-0650-2-2-140HA12-HU630	30391554
6,60	8	146	108	94	36	SCD131-0660-2-2-140HA12-HU630	30391555
7,00	8	146	108	94	36	SCD131-0700-2-2-140HA12-HU630	30391558
8,00	8	146	108	94	36	SCD131-0800-2-2-140HA12-HU630	30391568
9,00	10	162	120	110	40	SCD131-0900-2-2-140HA12-HU630	30391577

Możliwość konfiguracji parametrów

Średnica:
możliwość wyboru średnicy w krokach co 0,01 mm

Typ chwytu:
Typ chwytu: HB | HE

Specyfikacja:
SCD131-[średnica]-2-2-140[typ chwytu]12-HU630

Wymiary typoszeręgu z możliwością konfiguracji parametrów

d ₁ min.	d ₁ max.	d ₂ h6	l ₁	l ₂	l ₃	l ₄
3,00	3,70	6	92	54	48	36
3,71	4,70	6	102	64	58	36
4,71	6,00	6	116	78	70	36
6,01	8,00	8	146	108	94	36
8,01	10,00	10	162	120	110	40
10,01	12,00	12	204	156	142	45
12,01	14,00	14	230	182	166	45
14,01	16,00	16	260	208	192	48
16,01	18,00	18	285	234	216	48
18,01	20,00	20	310	258	240	50

Przykład:

SCD131-0431-2-2-140HE12-HU630

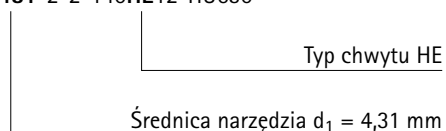

Wymiary podano w mm.

Zalecane parametry skrawania - patrz koniec rozdziału.

Wersje specjalne i inne powłoki wg zapytania ofertowego.

MEGA-Drill-Composite-MD

Wiertła spiralne z węgla spiekane

SCD250 (5xD), zewnętrzne doprowadzenie chłodziwa

Wersja:

Średnica wiertła: 0,50 – 12,00 mm

Materiał skrawający: HC611/619/620

Liczba ostrzy: 2

Liczba tyśinek: 2

Kąt wierzchołkowy: 90°

Kąt spirali: 35°

Zastosowanie:

CFK z wielokierunkowym przebiegiem włókien.

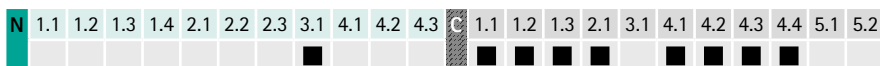
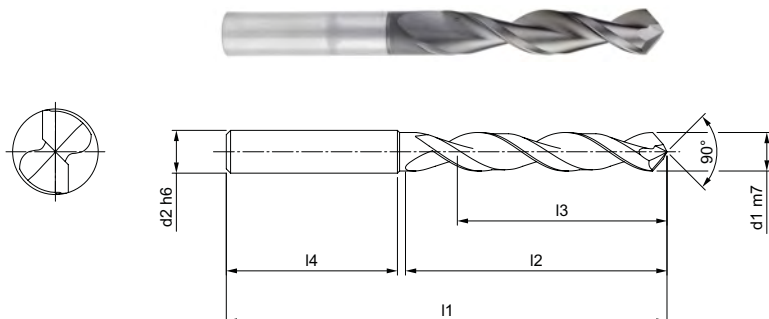

Wymiary						Typ chwytu HA	
d ₁ m7	d ₂ h6	l ₁	l ₂	l ₃	l ₄	Specyfikacja	Nr materiałowy
0,50	3	55	4,5	3	46	SCD250-0050-2-2-140HA05-HC620	30504673
2,00	3	68	14	11	51	SCD250-0200-2-2-140HA05-HC620	30504688
2,50	3	74	18	14	54	SCD250-0250-2-2-140HA05-HC620	30504693
3,00	6	66	28	23	36	SCD250-0300-2-2-090HA05-HC619	30401902
3,10	6	66	28	23	36	SCD250-0310-2-2-090HA05-HC619	30401903
3,20	6	66	28	23	36	SCD250-0320-2-2-090HA05-HC619	30401905
3,30	6	66	28	23	36	SCD250-0330-2-2-090HA05-HC619	30401906
3,80	6	66	28	23	36	SCD250-0380-2-2-090HA05-HC619	30401911
4,00	6	74	36	29	36	SCD250-0400-2-2-090HA05-HC619	30401913
4,10	6	74	36	29	36	SCD250-0410-2-2-090HA05-HC619	30401914
4,20	6	74	36	29	36	SCD250-0420-2-2-090HA05-HC619	30401915
4,30	6	74	36	29	36	SCD250-0430-2-2-090HA05-HC619	30401916
4,50	6	74	36	29	36	SCD250-0450-2-2-090HA05-HC619	30401918
4,80	6	74	36	29	36	SCD250-0480-2-2-090HA05-HC619	30401922
4,86	6	74	36	0	36	SCD250-0486-2-2-090HA05-HC619	30681789
5,00	6	82	44	35	36	SCD250-0500-2-2-090HA05-HC619	30401924
5,10	6	82	44	35	36	SCD250-0510-2-2-090HA05-HC619	30401925
5,20	6	82	44	35	36	SCD250-0520-2-2-090HA05-HC619	30401926
5,30	6	82	44	35	36	SCD250-0530-2-2-090HA05-HC619	30401927
5,50	6	82	44	35	36	SCD250-0550-2-2-090HA05-HC619	30401929
5,60	6	82	44	35	36	SCD250-0560-2-2-090HA05-HC619	30401930
5,80	6	82	44	35	36	SCD250-0580-2-2-090HA05-HC619	30401932
6,00	6	82	44	35	36	SCD250-0600-2-2-090HA05-HC619	30401934
6,50	8	91	53	43	36	SCD250-0650-2-2-090HA05-HC619	30401940
6,80	8	91	53	43	36	SCD250-0680-2-2-090HA05-HC619	30401943
7,00	8	91	53	43	36	SCD250-0700-2-2-090HA05-HC619	30401945
7,20	8	91	53	43	36	SCD250-0720-2-2-090HA05-HC619	30401947
7,50	8	91	53	43	36	SCD250-0750-2-2-090HA05-HC619	30401950
7,80	8	91	53	43	36	SCD250-0780-2-2-090HA05-HC619	30401953
8,00	8	91	53	43	36	SCD250-0800-2-2-090HA05-HC619	30401956
8,50	10	103	61	49	40	SCD250-0850-2-2-090HA05-HC611	30401961
8,80	10	103	61	49	40	SCD250-0880-2-2-090HA05-HC611	30401964
10,00	10	103	61	49	40	SCD250-1000-2-2-090HA05-HC611	30401977

MEGA-Drill-Composite-MD | Wiertła spiralne z węgla spiekane SCD250 (5xD), zewnętrzne doprowadzenie chłodziwa

Wymiary						Typ chwytu HA	
d ₁ m7	d ₂ h6	l ₁	l ₂	l ₃	l ₄	Specyfikacja	Nr materiałowy
10,10	12	118	71	56	45	SCD250-1010-2-2-090HA05-HC611	30401978
10,40	12	118	71	56	45	SCD250-1040-2-2-090HA05-HC611	30401981
10,70	12	118	71	56	45	SCD250-1070-2-2-090HA05-HC611	30401984
12,00	12	118	71	56	45	SCD250-1200-2-2-090HA05-HC611	30401998

Możliwość konfiguracji parametrów



Średnica:

możliwość wyboru średnicy w krokach co 0,01 mm



Typ chwytu:

Typ chwytu: HB | HE

Specyfikacja:

SCD250-[średnica]-2-2-090[typ chwytu]05-HC611

Wymiary typoszeregu z możliwością konfiguracji parametrów

d ₁ min.	d ₁ max.	d ₂ h6	l ₁	l ₂	l ₃	l ₄
3,00	3,99	6	66	28	23	36
4,00	4,99	6	74	36	29	36
5,00	6,00	6	82	44	35	36
6,01	8,00	8	91	53	43	36
8,01	10,00	10	103	61	49	40
10,01	12,00	12	118	71	56	45

Przykład:

SCD250-0431-2-2-090HE05-HC611

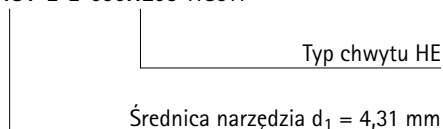

Wymiary podano w mm.

Zalecane parametry skrawania - patrz koniec rozdziału.

Wersje specjalne i inne powłoki wg zapytania ofertowego.

MEGA-Drill-Composite-UDX

Wiertła spiralne z węgla spiekane

SCD270 (5xD), zewnętrzne doprowadzenie chłodziwa

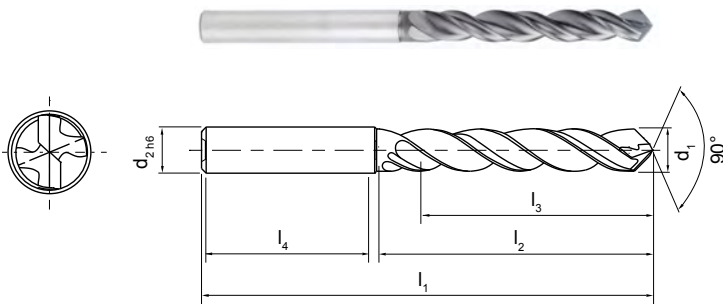

N	1.1	1.2	1.3	1.4	2.1	2.2	2.3	3.1	4.1	4.2	4.3	C	1.1	1.2	1.3	2.1	3.1	4.1	4.2	4.3	4.4	5.1	5.2
---	-----	-----	-----	-----	-----	-----	-----	-----	-----	-----	-----	---	-----	-----	-----	-----	-----	-----	-----	-----	-----	-----	-----



Magazynowa seria preferowana z typem chwytu HA

Wymiary						Typ chwytu HA	
d ₁ m7	d ₂ h6	l ₁	l ₂	l ₃	l ₄	Specyfikacja	Nr materiałowy
3,30	6	66	26	20	36	SCD270-0330-2-2-090HA05-HC619	30402105
4,00	6	74	35	27	36	SCD270-0400-2-2-090HA05-HC619	30402112
4,394	6	74	35	27	36	SCD270-04394-2-2-090HA05-HC619	30634827
4,50	6	74	35	27	36	SCD270-0450-2-2-090HA05-HC619	30402117
5,00	6	82	44	35	36	SCD270-0500-2-2-090HA05-HC619	30402123

Możliwość konfiguracji parametrów

Średnica:
możliwość wyboru średnicy w krokach
co 0,01 mm

Typ chwytu:
Typ chwytu: HB | HE

Specyfikacja:
SCD270-[średnica]-2-2-090[typ chwytu]05-HC619

Wymiary typoszeregu z możliwością konfiguracji parametrów

d ₁ min.	d ₁ max.	d ₂ h6	l ₁	l ₂	l ₃	l ₄
3,00	3,99	6	66	26	20	36
4,00	4,99	6	74	35	27	36
5,00	6,00	6	82	44	35	36
6,01	8,00	8	91	52	40	36
8,01	10,00	10	103	60	45	40
10,01	12,00	12	118	70	52	45

Przykład:

SCD270-0431-2-2-090HE05-HC619

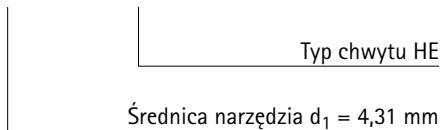

Wymiary podano w mm.

Zalecane parametry skrawania - patrz koniec rozdziału.

Wersje specjalne i inne powłoki wg zapytania ofertowego.

MEGA-Drill-Composite-UDX

Wiertła spiralne z węgliku spiekanego
SCD271 (5xD), wewnętrzne doprowadzenie chłodziwa

Wersja:
Średnica wiertła: 6,00 - 12,00 mm
Materiał skrawający: HC619
Liczba ostrzy: 2
Liczba łysinek: 3
Kąt wierzchołkowy: 90°
Kąt spirali: 35°

Zastosowanie:
Do wszystkich materiałów obrabianych CFK / idealne rozwiązanie w przypadku niestabilnych mocowań lub elementów cienkościennych.

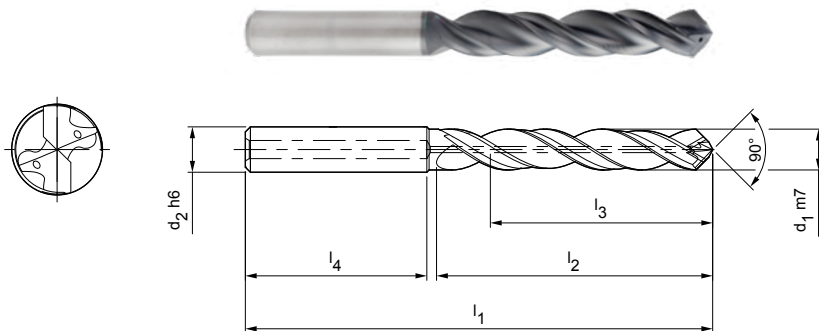

N	1.1	1.2	1.3	1.4	2.1	2.2	2.3	3.1	4.1	4.2	4.3	C	1.1	1.2	1.3	2.1	3.1	4.1	4.2	5.1	5.2	5.3
---	-----	-----	-----	-----	-----	-----	-----	-----	-----	-----	-----	---	-----	-----	-----	-----	-----	-----	-----	-----	-----	-----



Magazynowa seria preferowana z typem chwytu HA

Wymiary						Typ chwytu HA	
d ₁ m7	d ₂ h6	l ₁	l ₂	l ₃	l ₄	Specyfikacja	Nr materiałowy
6,00	6	82	44	35	36	SCD271-0600-2-2-090HA05-HC619	30402197
8,00	8	91	52	40	36	SCD271-0800-2-2-090HA05-HC619	30402219
10,00	10	103	60	45	40	SCD271-1000-2-2-090HA05-HC611	30402240

Możliwość konfiguracji parametrów

Średnica:
możliwość wyboru średnicy w krokach co 0,01 mm

Typ chwytu:
Typ chwytu: HB | HE

Specyfikacja:
SCD271-[średnica]-2-2-090[typ chwytu]05-HC619

Wymiary typoszeregu z możliwością konfiguracji parametrów

d ₁ min.	d ₁ max.	d ₂ h6	l ₁	l ₂	l ₃	l ₄
6,00	6,00	6	82	44	35	36
6,01	8,00	8	91	52	40	36
8,01	10,00	10	103	60	45	40
10,01	12,00	12	118	70	52	45

Przykład:
SCD271-0431-2-2-090HE05-HC619

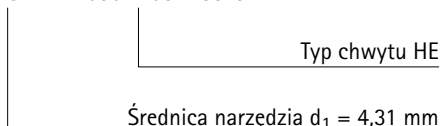

Wymiary podano w mm.

Zalecane parametry skrawania - patrz koniec rozdziału.

Wersje specjalne i inne powłoki wg zapytania ofertowego.

MEGA-180°-Drill-Alu

Wiertła spiralne z węgla spiekane
SCD241 (3xD), wewnętrzne doprowadzenie chłodziwa

Wersja:

Średnica wiertła:	3,00 – 20,00 mm
Tolerancja otworu:	≥ IT 9
Materiał skrawający:	HU630
Liczba ostrzy:	2
Liczba tyselek:	4
Kąt wierzchołkowy:	180°
Kąt spirali:	30°

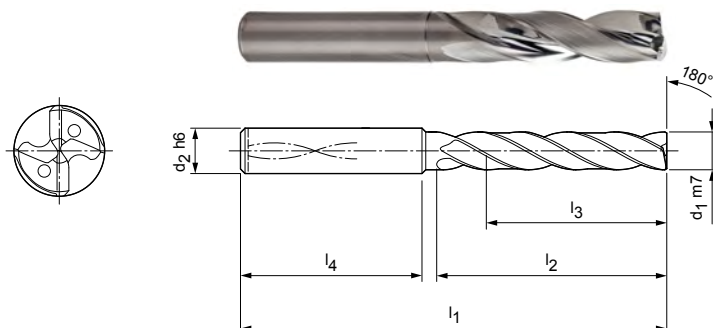

Magazynowa seria preferowana z typem chwytu HA

Wymiary						Typ chwytu HA	
d ₁ m7	d ₂ h6	l ₁	l ₂	l ₃	l ₄	Specyfikacja	Nr materiałowy
3,00	6	62	20	14	36	SCD241-0300-2-4-180HA03-HU630	30382883
3,70	6	62	20	14	36	SCD241-0370-2-4-180HA03-HU630	30382890
4,00	6	66	24	17	36	SCD241-0400-2-4-180HA03-HU630	30382893
4,20	6	66	24	17	36	SCD241-0420-2-4-180HA03-HU630	30382895
4,30	6	66	24	17	36	SCD241-0430-2-4-180HA03-HU630	30382896
4,60	6	66	24	17	36	SCD241-0460-2-4-180HA03-HU630	30382899
5,00	6	66	28	20	36	SCD241-0500-2-4-180HA03-HU630	30382904
5,50	6	66	28	20	36	SCD241-0550-2-4-180HA03-HU630	30382909
5,56	6	66	28	20	36	SCD241-0556-2-4-180HA03-HU630	30463897
6,00	6	66	28	20	36	SCD241-0600-2-4-180HA03-HU630	30382915
6,50	8	79	34	24	36	SCD241-0650-2-4-180HA03-HU630	30382920
6,70	8	79	34	24	36	SCD241-0670-2-4-180HA03-HU630	30382922
7,00	8	79	34	24	36	SCD241-0700-2-4-180HA03-HU630	30382925
7,20	8	79	41	29	36	SCD241-0720-2-4-180HA03-HU630	30382927
7,40	8	79	41	29	36	SCD241-0740-2-4-180HA03-HU630	30382929
7,50	8	79	41	29	36	SCD241-0750-2-4-180HA03-HU630	30382930
7,80	8	79	41	29	36	SCD241-0780-2-4-180HA03-HU630	30382933
8,00	8	79	41	29	36	SCD241-0800-2-4-180HA03-HU630	30382935
8,50	10	89	47	35	40	SCD241-0850-2-4-180HA03-HU630	30382940
8,90	10	89	47	35	40	SCD241-0890-2-4-180HA03-HU630	30382944
9,00	10	89	47	35	40	SCD241-0900-2-4-180HA03-HU630	30382945
9,20	10	89	47	35	40	SCD241-0920-2-4-180HA03-HU630	30382947
9,80	10	89	47	35	40	SCD241-0980-2-4-180HA03-HU630	30382953
10,00	10	89	47	35	40	SCD241-1000-2-4-180HA03-HU630	30382955
11,00	12	100	53	38	45	SCD241-1100-2-4-180HA03-HU630	30382965
12,00	12	100	53	38	45	SCD241-1200-2-4-180HA03-HU630	30382975
13,00	14	105	58	41	45	SCD241-1300-2-4-180HA03-HU630	30382978
14,50	16	113	63	43	48	SCD241-1450-2-4-180HA03-HU630	30382982
17,00	18	121	71	49	48	SCD241-1700-2-4-180HA03-HU630	30382990
18,50	20	129	77	53	50	SCD241-1850-2-4-180HA03-HU630	30382994

MEGA-180°-Drill-Alu | Wiertła spiralne z węgla spiekane SCD241 (3xD), wewnętrzne doprowadzenie chłodziwa

Możliwość konfiguracji parametrów



Średnica:
możliwość wyboru średnicy w krokach
co 0,01 mm



Typ chwytu:
Typ chwytu: HB | HE

Specyfikacja:

SCD241-[średnica]-2-4-180[typ chwytu]03-HU630

Przykład:

SCD241-0431-2-4-180HE03-HU630

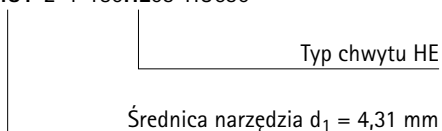

Wymiary typoszeregu z możliwością konfiguracji parametrów

d ₁ min.	d ₁ max.	d ₂ h6	l ₁	l ₂	l ₃	l ₄
3,00	3,70	6	62	20	14	36
3,71	4,70	6	66	24	17	36
4,71	6,00	6	66	28	20	36
6,01	6,80	8	79	34	24	36
6,81	8,00	8	79	41	29	36
8,01	10,00	10	89	47	35	40
10,01	12,00	12	100	53	38	45
12,0	14,00	14	105	58	41	45
14,01	16,00	16	113	63	43	48
16,01	18,00	18	121	71	49	48
18,01	20,00	20	129	77	53	50

Wymiary podano w mm.

Zalecane parametry skrawania - patrz koniec rozdziału.

Wersje specjalne i inne powłoki wg zapytania ofertowego.

MEGA-180°-Drill-Alu

Wiertła spiralne z węgla spiekane
SCD241 (5xD), wewnętrzne doprowadzenie chłodziwa

Wersja:

Średnica wiertła:	3,00 – 20,00 mm
Tolerancja otworu:	≥ IT 9
Materiał skrawający:	HU630
Liczba ostrzy:	2
Liczba tyselek:	4
Kąt wierzchołkowy:	180°
Kąt spirali:	30°

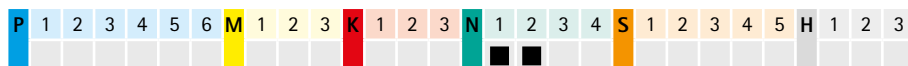
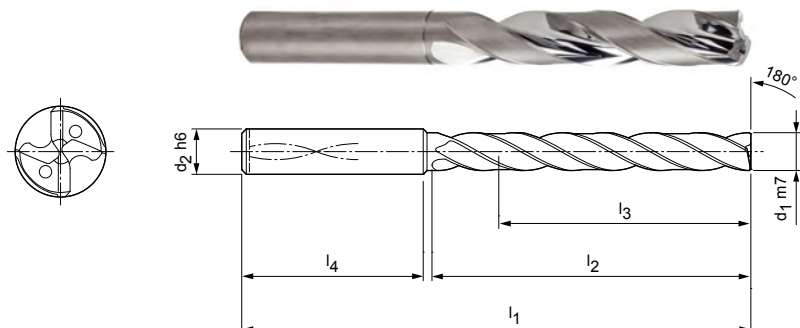

Magazynowa seria preferowana z typem chwytu HA

Wymiary						Typ chwytu HA	
d ₁ m7	d ₂ h6	l ₁	l ₂	l ₃	l ₄	Specyfikacja	Nr materiałowy
3,00	6	66	28	23	36	SCD241-0300-2-4-180HA05-HU630	30383000
3,50	6	66	28	23	36	SCD241-0350-2-4-180HA05-HU630	30383005
4,00	6	74	36	29	36	SCD241-0400-2-4-180HA05-HU630	30383010
4,10	6	74	36	29	36	SCD241-0410-2-4-180HA05-HU630	30383011
4,80	6	82	44	35	36	SCD241-0480-2-4-180HA05-HU630	30383019
5,00	6	82	44	35	36	SCD241-0500-2-4-180HA05-HU630	30383021
5,60	6	82	44	35	36	SCD241-0560-2-4-180HA05-HU630	30383028
6,00	6	82	44	35	36	SCD241-0600-2-4-180HA05-HU630	30383032
6,50	8	91	53	43	36	SCD241-0650-2-4-180HA05-HU630	30383037
7,00	8	91	53	43	36	SCD241-0700-2-4-180HA05-HU630	30383042
7,50	8	91	53	43	36	SCD241-0750-2-4-180HA05-HU630	30383047
8,00	8	91	53	43	36	SCD241-0800-2-4-180HA05-HU630	30383052
8,20	10	103	61	49	40	SCD241-0820-2-4-180HA05-HU630	30383054
8,50	10	103	61	49	40	SCD241-0850-2-4-180HA05-HU630	30383057
9,00	10	103	61	49	40	SCD241-0900-2-4-180HA05-HU630	30383062
9,30	10	103	61	49	40	SCD241-0930-2-4-180HA05-HU630	30383066
10,00	10	103	61	49	40	SCD241-1000-2-4-180HA05-HU630	30383073
12,00	12	116	69	54	45	SCD241-1200-2-4-180HA05-HU630	30383093
13,00	14	122	75	58	45	SCD241-1300-2-4-180HA05-HU630	30383096
14,00	14	122	75	58	45	SCD241-1400-2-4-180HA05-HU630	30383099
15,00	16	131	81	61	48	SCD241-1500-2-4-180HA05-HU630	30383102
15,70	16	131	81	61	48	SCD241-1570-2-4-180HA05-HU630	31237410
20,00	20	151	99	75	50	SCD241-2000-2-4-180HA05-HU630	30383117

MEGA-180°-Drill-Alu | Wiertła spiralne z węgla spiekane SCD241 (5xD), wewnętrzne doprowadzenie chłodziwa

Możliwość konfiguracji parametrów



Średnica:
możliwość wyboru średnicy w krokach
co 0,01 mm



Typ chwytu:
Typ chwytu: HB | HE

Specyfikacja:

SCD241-[średnica]-2-4-180[typ chwytu]05-HU630

Wymiary typoszeregu z możliwością konfiguracji parametrów

d ₁ min.	d ₁ max.	d ₂ h6	l ₁	l ₂	l ₃	l ₄
3,00	3,70	6	66	28	23	36
3,71	4,70	6	74	36	29	36
4,71	6,00	6	82	44	35	36
6,01	8,00	8	91	53	43	36
8,01	10,00	10	103	61	49	40
10,01	12,00	12	116	69	54	45
12,01	14,00	14	122	75	58	45
14,01	16,00	16	131	81	61	48
16,01	18,00	18	141	91	69	48
18,01	20,00	20	151	99	75	50

Przykład:

SCD241-0431-2-4-180HE05-HU630

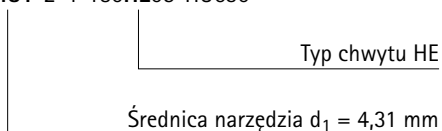

Wymiary podano w mm.

Zalecane parametry skrawania - patrz koniec rozdziału.

Wersje specjalne i inne powłoki wg zapytania ofertowego.

ECU-G-Drill

Wiertła z węgla spiekane, z rowkami prostymi
SCD211 (5xD), wewnętrzne doprowadzenie chłodziwa

Wersja:

Średnica wiertła: 4,80 – 7,50 mm

Tolerancja otworu: \geq IT 9

Materiał skrawający: HU610

Liczba ostrzy: 2

Liczba tyselek: 4

Kąt wierzchołkowy: 130°

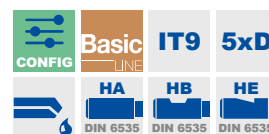
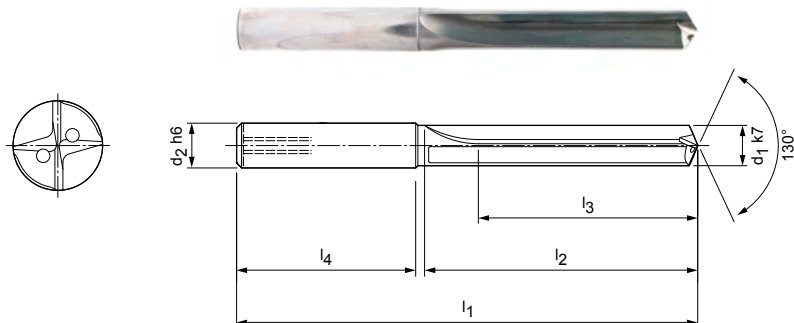

Magazynowa seria preferowana z typem chwytu HA

Wymiary						Typ chwytu HA	
d ₁ k7	d ₂ h6	l ₁	l ₂	l ₃	l ₄	Specyfikacja	Nr materiałowy
4,80	6	82	44	35	36	SCD211-0480-2-4-130HA05-HU610	30392622
5,50	6	82	44	35	36	SCD211-0550-2-4-130HA05-HU610	30392630
5,70	6	82	44	35	36	SCD211-0570-2-4-130HA05-HU610	30392632
5,80	6	82	44	35	36	SCD211-0580-2-4-130HA05-HU610	30392633
6,80	8	91	53	43	36	SCD211-0680-2-4-130HA05-HU610	30392643
7,40	8	91	53	43	36	SCD211-0740-2-4-130HA05-HU610	30392649
7,50	8	91	53	43	36	SCD211-0750-2-4-130HA05-HU610	30392650

Możliwość konfiguracji parametrów



Typ chwytu:
Typ chwytu: HB | HE



Specyfikacja:

SCD211-0430-2-4-130[typ chwytu]05-HU610

Przykład:

SCD211-0430-3-3-140HE05-HU610

Typ chwytu HE

Wymiary podano w mm.

Zalecane parametry skrawania - patrz koniec rozdziału.

Wersje specjalne i inne powłoki wg zapytania ofertowego.

ECU-G-Drill

Wiertła z węgla spiekane, z rowkami prostymi
SCD211 (8xD), wewnętrzne doprowadzenie chłodziwa

Wersja:

Średnica wiertła: 5,80 – 11,60 mm
Tolerancja otworu: $\geq IT 9$
Materiał skrawający: HU610
Liczba ostrzy: 2
Liczba łysinek: 4
Kąt wierzołkowy: 130°

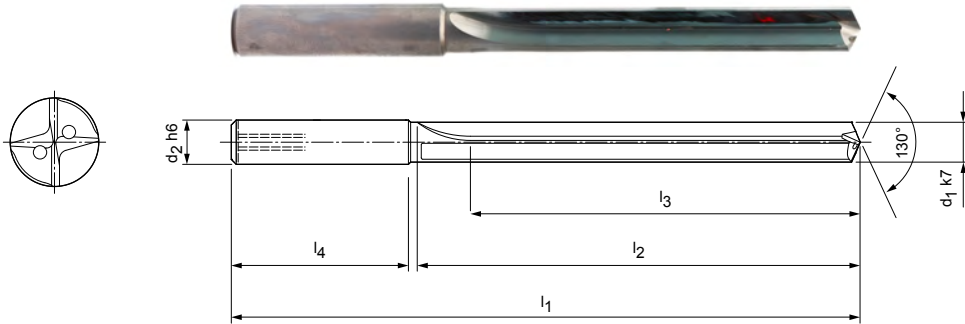

Magazynowa seria preferowana z typem chwytu HA

Wymiary						Typ chwytu HA	
d ₁ k7	d ₂ h6	l ₁	l ₂	l ₃	l ₄	Specyfikacja	Nr materiałowy
5,80	6	95	57	48	36	SCD211-0580-2-4-130HA08-HU610	30392739
11,60	12	162	114	96	45	SCD211-1160-2-4-130HA08-HU610	30392797

Możliwość konfiguracji parametrów

Typ chwytu:
Typ chwytu: HB | HE

Specyfikacja:
SCD211-0430-2-4-130[typ chwytu]08-HU610

Przykład:

SCD211-0430-3-3-140HE08-HU610

Typ chwytu HE

Wymiary podano w mm.

Zalecane parametry skrawania - patrz koniec rozdziału.

Wersje specjalne i inne powłoki wg zapytania ofertowego.

Zalecane parametry skrawania dla wiertel z węglika spiekanego

Posuw i prędkość skrawania

Tritan-Drill-Uni-Plus | SCD631

MZG*	Materiał obrabiany	Wytrzymałość/twardość [N/mm ²] [HRC]
P	P1.1 Stale konstrukcyjne, użytkowe i uszlachetnione, stale niestopowe	< 700
	P1.2 Stale konstrukcyjne, użytkowe i uszlachetnione, stale niestopowe	< 1 200
	P2.1 Stale azotowane, użytkowe i uszlachetnione, stale stopowe	< 900
	P2.2 Stale azotowane, użytkowe i uszlachetnione, stale stopowe	< 1 400
	P3.1 Stale narzędziowe, łożyskowe, sprężynowe i stale szybko tnące**	< 800
	P3.2 Stale narzędziowe, łożyskowe, sprężynowe i stale szybko tnące**	< 1 000
	P3.3 Stale narzędziowe, łożyskowe, sprężynowe i stale szybko tnące**	< 1 500
	P5.1 Staliwo	
M	M1.1 Stale nierdzewne, austenityczne	< 700
	M1.2 Stale nierdzewne, ferrytyczne/austenityczne (Duplex)	< 1 000
K	K1.1 Żeliwo z grafitem płatkowym (żeliwo szare), GJL	< 300
	K2.1 Żeliwo sferoidalne, GJS	< 500
	K2.2 Żeliwo sferoidalne, GJS	≤ 800
	K2.3 Żeliwo sferoidalne, GJS	> 800
	K3.1 Żeliwo wermikularne, GJV, (żeliwo ciągliwe), GJL	< 500
	K3.2 Żeliwo wermikularne, GJV, (żeliwo ciągliwe), GJL	> 500
N	N1.1 Aluminium, niestopowe i stopowe < 3 % Si	
	N1.2 Aluminium, stopowe ≤ 7 % Si	
	N1.3 Aluminium, stopowe > 7-12 % Si	
	N1.4 Aluminium, stopowe > 12 % Si	
	N2.1 Miedź, niestopowa i niskostopowa	< 300
	N2.2 Miedź, stopowa	> 300
	N2.3 Mosiądz, brąz, spiż	< 1 200

MEGA-Speed-Drill-Uni | SCD221

MZG*	Materiał obrabiany	Wytrzymałość/twardość [N/mm ²] [HRC]
P	P1.1 Stale konstrukcyjne, użytkowe i uszlachetnione, stale niestopowe	< 700
	P1.2 Stale konstrukcyjne, użytkowe i uszlachetnione, stale niestopowe	< 1 200
	P2.1 Stale azotowane, użytkowe i uszlachetnione, stale stopowe	< 900
	P2.2 Stale azotowane, użytkowe i uszlachetnione, stale stopowe	< 1 400
	P3.1 Stale narzędziowe, łożyskowe, sprężynowe i stale szybko tnące**	< 800
	P3.2 Stale narzędziowe, łożyskowe, sprężynowe i stale szybko tnące**	< 1 000
	P3.3 Stale narzędziowe, łożyskowe, sprężynowe i stale szybko tnące**	< 1 500
	P4.1 Stale nierdzewne, ferrytyczne i martenzytyczne	
	P5.1 Staliwo	
	P6.1 Staliwo nierdzewne, ferrytyczne i martenzytyczne	
K	K1.1 Żeliwo z grafitem płatkowym (żeliwo szare), GJL	< 300
	K2.1 Żeliwo sferoidalne, GJS	< 500
	K2.2 Żeliwo sferoidalne, GJS	≤ 800
	K2.3 Żeliwo sferoidalne, GJS	> 800
	K3.1 Żeliwo wermikularne, GJV, (żeliwo ciągliwe), GJL	< 500
	K3.2 Żeliwo wermikularne, GJV, (żeliwo ciągliwe), GJL	> 500

* Grupa materiałowa wg MAPAL

** Jeśli składniki stopu Cr, Mo, Ni, V, W wynoszą łącznie > 8%, należy wybrać następną w kolejności grupę materiałową MAPAL.

	Prędkość skrawania v_c [m/min]				Posuw f [mm] przy średnicy wiertła					
	Chłodzenie wewnętrzne	Chłodzenie zewnętrzne	Mgietka	Powietrze	4,00	5,50	7,50	10,50	14,50	20,00
	115	105	105		0,22	0,27	0,34	0,42	0,51	0,59
	105	85	85		0,27	0,34	0,42	0,53	0,64	0,74
	115	100	100		0,25	0,32	0,40	0,50	0,60	0,70
	80	70	70		0,21	0,26	0,32	0,40	0,48	0,55
	85	75	75		0,23	0,29	0,36	0,45	0,54	0,63
	70	65	65		0,19	0,24	0,30	0,37	0,44	0,51
	70	50	60		0,16	0,19	0,24	0,29	0,34	0,40
	115	100	100		0,25	0,32	0,40	0,50	0,60	0,70
	55	35	35		0,11	0,14	0,18	0,22	0,27	0,31
	140	100	100	100	0,31	0,41	0,53	0,68	0,84	0,98
	185	115	140	140	0,30	0,39	0,50	0,64	0,78	0,91
	115	85	85		0,27	0,35	0,44	0,55	0,67	0,78
	70	45	60		0,14	0,18	0,22	0,28	0,33	0,38
	105	90	90		0,29	0,37	0,47	0,59	0,72	0,84
	90	80	80		0,25	0,31	0,38	0,48	0,57	0,66
	345	230	290		0,22	0,27	0,34	0,42	0,51	0,59
	290	205	230		0,27	0,35	0,44	0,55	0,67	0,78
	255	175	205		0,27	0,35	0,44	0,55	0,67	0,78
	205	140	175		0,27	0,35	0,44	0,55	0,67	0,78
	140	105			0,20	0,26	0,33	0,41	0,50	0,58
230	185	185	140	0,31	0,41	0,53	0,68	0,84	0,98	

	Prędkość skrawania v_c [m/min]				Posuw f [mm] przy średnicy wiertła					
	Chłodzenie wewnętrzne	Chłodzenie zewnętrzne	Mgietka	Powietrze	3,00	4,50	6,50	9,50	14,00	20,00
	170	155	155		0,11	0,14	0,18	0,23	0,30	0,36
	155	130	130		0,14	0,18	0,22	0,29	0,37	0,45
	170	145	145		0,13	0,17	0,21	0,27	0,35	0,43
	120	100	100		0,11	0,14	0,17	0,22	0,28	0,34
	130	110	110		0,11	0,15	0,19	0,25	0,32	0,38
	115	100	95		0,10	0,14	0,17	0,22	0,28	0,35
	100	75	85		0,10	0,13	0,16	0,20	0,26	0,31
	100	75	85		0,08	0,10	0,13	0,16	0,21	0,25
	170	145	145		0,13	0,17	0,21	0,27	0,35	0,43
	100	75	85		0,08	0,10	0,13	0,16	0,21	0,25
	150	105	105	105	0,13	0,19	0,26	0,35	0,45	0,54
	200	125	150	150	0,13	0,18	0,25	0,33	0,42	0,50
	125	95	95		0,12	0,16	0,22	0,28	0,36	0,43
	75	50	65		0,09	0,12	0,15	0,19	0,24	0,28
	115	100	100		0,13	0,18	0,23	0,31	0,39	0,46
	100	90	90		0,11	0,15	0,19	0,25	0,31	0,36

Podane parametry skrawania to wartości orientacyjne.

Optymalne wartości dla danego przypadku obróbki należy ustalić w ramach próby lub podczas obróbki.

Zalecane parametry skrawania dla wiertła z węglika spiekanego

Posuw i prędkość skrawania

ECU-Drill-Uni | SCD350, 351

MZG*		Materiał obrabiany	Wytrzymałość/twardość [N/mm ²] [HRC]
P	P1	P1.1 Stale konstrukcyjne, użytkowe i uszlachetnione, stale niestopowe	< 700
		P1.2 Stale konstrukcyjne, użytkowe i uszlachetnione, stale niestopowe	< 1 200
	P2	P2.1 Stale azotowane, użytkowe i uszlachetnione, stale stopowe	< 900
		P2.2 Stale azotowane, użytkowe i uszlachetnione, stale stopowe	< 1 400
	P3	P3.1 Stale narzędziowe, łożyskowe, sprężynowe i stale szybko tnące**	< 800
		P3.2 Stale narzędziowe, łożyskowe, sprężynowe i stale szybko tnące**	< 1 000
		P3.3 Stale narzędziowe, łożyskowe, sprężynowe i stale szybko tnące**	< 1 500
	P5	P5.1 Staliwo	
M	M1	M1.1 Stale nierdzewne, austenityczne	< 700
		M1.2 Stale nierdzewne, ferrytyczne/austenityczne (Duplex)	< 1 000
	M2	M2.1 Staliwo nierdzewne, austenityczne	< 700
	M3	M3.1 Staliwo nierdzewne, ferrytyczne/austenityczne (Duplex)	< 1 000
K	K2	K2.1 Żeliwo sferoidalne, GJS	< 500
		K2.2 Żeliwo sferoidalne, GJS	≤ 800
		K2.3 Żeliwo sferoidalne, GJS	> 800

MEGA-Drill-Steel-Plus | SCD600, 601

MZG*		Materiał obrabiany	Wytrzymałość/twardość [N/mm ²] [HRC]
P	P1	P1.1 Stale konstrukcyjne, użytkowe i uszlachetnione, stale niestopowe	< 700
		P1.2 Stale konstrukcyjne, użytkowe i uszlachetnione, stale niestopowe	< 1 200
	P2	P2.1 Stale azotowane, użytkowe i uszlachetnione, stale stopowe	< 900
		P2.2 Stale azotowane, użytkowe i uszlachetnione, stale stopowe	< 1 400
	P3	P3.1 Stale narzędziowe, łożyskowe, sprężynowe i stale szybko tnące**	< 800
		P3.2 Stale narzędziowe, łożyskowe, sprężynowe i stale szybko tnące**	< 1 000
		P3.3 Stale narzędziowe, łożyskowe, sprężynowe i stale szybko tnące**	< 1 500
	P4	P4.1 Stale nierdzewne, ferrytyczne i martenzytyczne	
P5	P5.1 Staliwo		
P6	P6.1 Staliwo nierdzewne, ferrytyczne i martenzytyczne		
K	K1	K1.1 Żeliwo z grafitem płatkowym (żeliwo szare), GJL	< 300
		K2.1 Żeliwo sferoidalne, GJS	< 500
	K2	K2.2 Żeliwo sferoidalne, GJS	≤ 800
		K2.3 Żeliwo sferoidalne, GJS	> 800
	K3	K3.1 Żeliwo wermikularne, GJV, (żeliwo ciągliwe), GJL	< 500
		K3.2 Żeliwo wermikularne, GJV, (żeliwo ciągliwe), GJL	> 500
H	H1	H1.1 Stal utwardzana/staliwo	< 44
		H1.2 Stal utwardzana/staliwo	< 55

* Grupa materiałowa wg MAPAL

** Jeśli składniki stopu Cr, Mo, Ni, V, W wynoszą łącznie > 8%, należy wybrać następną w kolejności grupę materiałową MAPAL.

	Prędkość skrawania v_c [m/min]				Posuw f [mm] przy średnicy wiertła					
	Chłodzenie wewnętrzne	Chłodzenie zewnętrzne	Mgietka	Powietrze	1,00	1,82	3,31	6,03	10,99	20,00
	75	70	70		0,03	0,05	0,07	0,10	0,16	0,21
	70	55	55		0,04	0,06	0,08	0,13	0,20	0,27
	75	65	65		0,04	0,05	0,08	0,12	0,18	0,25
	55	45	45		0,04	0,05	0,07	0,10	0,15	0,20
	55	50	50		0,03	0,05	0,07	0,11	0,17	0,23
	45	40	40		0,03	0,04	0,06	0,09	0,14	0,18
	45	35	40		0,03	0,04	0,05	0,07	0,11	0,14
	75	65	65		0,04	0,05	0,08	0,12	0,18	0,25
	45	30	30		0,03	0,04	0,06	0,09	0,14	0,19
	45	25	25		0,02	0,03	0,05	0,08	0,12	0,16
	45	30	30		0,03	0,04	0,06	0,09	0,14	0,19
	45	25	25		0,02	0,03	0,05	0,08	0,12	0,16
	120	75	90	90	0,05	0,07	0,12	0,19	0,30	0,41
	75	55	55		0,04	0,07	0,11	0,17	0,26	0,35

	Prędkość skrawania v_c [m/min]				Posuw f [mm] przy średnicy wiertła					
	Chłodzenie wewnętrzne	Chłodzenie zewnętrzne	Mgietka	Powietrze	3,00	4,50	6,50	9,50	14,00	20,00
	110	100	100		0,10	0,13	0,17	0,22	0,28	0,33
	100	85	85		0,12	0,16	0,21	0,27	0,34	0,41
	110	95	95		0,11	0,15	0,20	0,26	0,33	0,38
	75	65	65		0,10	0,13	0,16	0,21	0,26	0,30
	85	70	70		0,10	0,14	0,18	0,23	0,29	0,35
	65	60	60		0,09	0,12	0,15	0,19	0,24	0,28
	65	50	55		0,07	0,09	0,12	0,15	0,19	0,22
	65	50	55		0,07	0,09	0,12	0,15	0,19	0,23
	110	95	95		0,11	0,15	0,20	0,26	0,33	0,38
	65	50	55		0,07	0,09	0,12	0,15	0,19	0,23
	120	85	85	85	0,13	0,19	0,26	0,35	0,45	0,54
	160	100	120	120	0,13	0,18	0,25	0,33	0,42	0,50
	100	75	75		0,12	0,16	0,22	0,28	0,36	0,43
	60	40	50		0,09	0,12	0,15	0,19	0,24	0,28
	90	80	80		0,13	0,18	0,23	0,31	0,39	0,46
	80	70	70		0,11	0,15	0,19	0,25	0,31	0,36
	90	90	90		0,09	0,12	0,15	0,19	0,24	0,28
	25	25	25		0,05	0,06	0,08	0,11	0,14	0,16

Podane parametry skrawania to wartości orientacyjne.

Optymalne wartości dla danego przypadku obróbki należy ustalić w ramach próby lub podczas obróbki.

Zalecane parametry skrawania dla wiertła z węglika spiekanego

Posuw i prędkość skrawania

MEGA-Quadro-Drill-Plus | SCD610, 611

MZG*	Materiał obrabiany		Wytrzymałość/twardość [N/mm ²] [HRC]
P	P1	P1.1 Stale konstrukcyjne, użytkowe i uszlachetnione, stale niestopowe	< 700
		P1.2 Stale konstrukcyjne, użytkowe i uszlachetnione, stale niestopowe	< 1 200
	P2	P2.1 Stale azotowane, użytkowe i uszlachetnione, stale stopowe	< 900
		P2.2 Stale azotowane, użytkowe i uszlachetnione, stale stopowe	< 1 400
	P3	P3.1 Stale narzędziowe, łożyskowe, sprężynowe i stale szybkoobrotowe*	< 800
		P3.2 Stale narzędziowe, łożyskowe, sprężynowe i stale szybkoobrotowe*	< 1 000
		P3.3 Stale narzędziowe, łożyskowe, sprężynowe i stale szybkoobrotowe*	< 1 500
	P5	P5.1 Staliwo	
K	K1	K1.1 Żeliwo z grafitem płatkowym (żeliwo szare), GJL	< 300
		K2.1 Żeliwo sferoidalne, GJS	< 500
	K2	K2.2 Żeliwo sferoidalne, GJS	≤ 800
		K2.3 Żeliwo sferoidalne, GJS	> 800
	K3	K3.1 Żeliwo wermikularne, GJV, (żeliwo ciągliwe), GJL	< 500
		K3.2 Żeliwo wermikularne, GJV, (żeliwo ciągliwe), GJL	> 500

MICRO-Drill-Steel | SCD371

MZG*	Materiał obrabiany		Wytrzymałość/twardość [N/mm ²] [HRC]
P	P1	P1.1 Stale konstrukcyjne, użytkowe i uszlachetnione, stale niestopowe	< 700
		P1.2 Stale konstrukcyjne, użytkowe i uszlachetnione, stale niestopowe	< 1 200
	P2	P2.1 Stale azotowane, użytkowe i uszlachetnione, stale stopowe	< 900
		P2.2 Stale azotowane, użytkowe i uszlachetnione, stale stopowe	< 1 400
	P3	P3.1 Stale narzędziowe, łożyskowe, sprężynowe i stale szybkoobrotowe*	< 800
		P3.2 Stale narzędziowe, łożyskowe, sprężynowe i stale szybkoobrotowe*	< 1 000
		P3.3 Stale narzędziowe, łożyskowe, sprężynowe i stale szybkoobrotowe*	< 1 500
	P5	P5.1 Staliwo	
M	M1	M1.1 Stale nierdzewne, austenityczne	< 700
		M1.2 Stale nierdzewne, ferrytyczne/austenityczne (Duplex)	< 1000
K	K1	K1.1 Żeliwo z grafitem płatkowym (żeliwo szare), GJL	< 300
		K2.1 Żeliwo sferoidalne, GJS	< 500
	K2	K2.2 Żeliwo sferoidalne, GJS	≤ 800
		K2.3 Żeliwo sferoidalne, GJS	> 800
	K3	K3.1 Żeliwo wermikularne, GJV, (żeliwo ciągliwe), GJL	< 500
		K3.2 Żeliwo wermikularne, GJV, (żeliwo ciągliwe), GJL	> 500

MEGA-Drill-Hardened | SCD141

MZG*	Materiał obrabiany		Wytrzymałość/twardość [N/mm ²] [HRC]
H	H1	H1.1 Stal utwardzana/staliwo	< 44
		H1.2 Stal utwardzana/staliwo	< 55
	H2	H2.1 Stal utwardzana/staliwo	< 60
		H2.2 Stal utwardzana/staliwo	< 65
		H2.3 Stal utwardzana/staliwo	< 68

* Grupa materiałowa wg MAPAL

** Jeśli składniki stopu Cr, Mo, Ni, V, W wynoszą łącznie > 8%, należy wybrać następną w kolejności grupę materiałową MAPAL.

	Prędkość skrawania v_c [m/min]				Posuw f [mm] przy średnicy wiertła					
	Chłodzenie wewnętrzne	Chłodzenie zewnętrzne	Mgietka	Powietrze	4,00	5,50	7,50	10,50	14,50	20,00
	110	100	100		0,10	0,13	0,17	0,22	0,28	0,33
	100	85	85		0,12	0,16	0,21	0,27	0,34	0,41
	110	95	95		0,11	0,15	0,20	0,26	0,33	0,38
	75	65	65		0,10	0,13	0,16	0,21	0,26	0,30
	85	70	70		0,10	0,14	0,18	0,23	0,29	0,35
	65	60	60		0,09	0,12	0,15	0,19	0,24	0,28
	65	50	55		0,07	0,09	0,12	0,15	0,19	0,22
	110	95	95		0,11	0,15	0,20	0,26	0,33	0,38
	130	95	95	95	0,13	0,19	0,26	0,35	0,45	0,54
	175	110	130	130	0,13	0,18	0,25	0,33	0,42	0,50
	110	85	85		0,12	0,16	0,22	0,28	0,36	0,43
	65	45	55		0,09	0,12	0,15	0,19	0,24	0,28
	100	90	90		0,13	0,18	0,23	0,31	0,39	0,46
	90	75	75		0,11	0,15	0,19	0,25	0,31	0,36

	Prędkość skrawania v_c [m/min]				Posuw f [mm] przy średnicy wiertła					
	Chłodzenie wewnętrzne	Chłodzenie zewnętrzne	Mgietka	Powietrze	4,00	5,50	7,50	10,50	14,50	20,00
	80	70	70		0,04	0,04	0,05	0,06	0,07	0,08
	70	60	60		0,04	0,05	0,06	0,07	0,08	0,10
	80	70	70		0,04	0,05	0,06	0,07	0,08	0,09
	55	50	50		0,04	0,05	0,05	0,06	0,07	0,08
	60	50	50		0,04	0,04	0,05	0,06	0,07	0,08
	50	45	45		0,04	0,04	0,04	0,05	0,06	0,07
	50	35	40		0,03	0,04	0,04	0,05	0,05	0,06
	80	70	70		0,04	0,05	0,06	0,07	0,08	0,09
	40	25	25		0,03	0,03	0,03	0,04	0,05	0,06
	95	70	70	70	0,03	0,04	0,05	0,06	0,08	0,11
	130	80	95	95	0,04	0,05	0,06	0,07	0,09	0,11
	80	60	60		0,04	0,05	0,05	0,07	0,08	0,10
	70	65	65		0,04	0,05	0,06	0,07	0,09	0,11
	65	55	55		0,04	0,05	0,06	0,07	0,08	0,09

	Prędkość skrawania v_c [m/min]				Posuw f [mm] przy średnicy wiertła					
	Chłodzenie wewnętrzne	Chłodzenie zewnętrzne	Mgietka	Powietrze	2,50	3,62	5,25	7,61	11,04	16,00
	80	80	80		0,07	0,09	0,11	0,02	0,19	0,20
	30	30	30		0,05	0,06	0,08	0,10	0,13	0,16
		30	30		0,04	0,05	0,07	0,09	0,11	0,13
		20	20		0,03	0,04	0,05	0,06	0,08	0,09
		15	15		0,03	0,04	0,05	0,06	0,08	0,09

Podane parametry skrawania to wartości orientacyjne.

Optymalne wartości dla danego przypadku obróbki należy ustalić w ramach próby lub podczas obróbki.

Zalecane parametry skrawania dla wiertła z węglika spiekanego

Posuw i prędkość skrawania

Tritan-Drill-Steel | SCD661

MZG*		Materiał obrabiany	Wytrzymałość/twardość [N/mm ²] [HRC]
P	P1	P1.1 Stale konstrukcyjne, użytkowe i uszlachetnione, stale niestopowe	< 700
		P1.2 Stale konstrukcyjne, użytkowe i uszlachetnione, stale niestopowe	< 1 200
	P2	P2.1 Stale azotowane, użytkowe i uszlachetnione, stale stopowe	< 900
		P2.2 Stale azotowane, użytkowe i uszlachetnione, stale stopowe	< 1 400
	P3	P3.1 Stale narzędziowe, łożyskowe, sprężynowe i stale szybko tnące**	< 800
		P3.2 Stale narzędziowe, łożyskowe, sprężynowe i stale szybko tnące**	< 1 000
		P3.3 Stale narzędziowe, łożyskowe, sprężynowe i stale szybko tnące**	< 1 500
	P5	P5.1 Staliwo	
M	M1	M1.1 Stale nierdzewne, austenityczne	< 700
		M1.2 Stale nierdzewne, ferrytyczne/austenityczne (Duplex)	< 1 000
K	K1	K1.1 Żeliwo z grafitem płatkowym (żeliwo szare), GJL	< 300
		K2.1 Żeliwo sferoidalne, GJS	< 500
	K2	K2.2 Żeliwo sferoidalne, GJS	≤ 800
		K2.3 Żeliwo sferoidalne, GJS	> 800
	K3	K3.1 Żeliwo wermikularne, GJV, (żeliwo ciągliwe), GJL	< 500
		K3.2 Żeliwo wermikularne, GJV, (żeliwo ciągliwe), GJL	> 500

MEGA-Speed-Drill-Steel | SCD621

MZG*		Materiał obrabiany	Wytrzymałość/twardość [N/mm ²] [HRC]
P	P1	P1.1 Stale konstrukcyjne, użytkowe i uszlachetnione, stale niestopowe	< 700
		P1.2 Stale konstrukcyjne, użytkowe i uszlachetnione, stale niestopowe	< 1 200
	P2	P2.1 Stale azotowane, użytkowe i uszlachetnione, stale stopowe	< 900
		P2.2 Stale azotowane, użytkowe i uszlachetnione, stale stopowe	< 1 400
	P3	P3.1 Stale narzędziowe, łożyskowe, sprężynowe i stale szybko tnące**	< 800
		P3.2 Stale narzędziowe, łożyskowe, sprężynowe i stale szybko tnące**	< 1 000
		P3.3 Stale narzędziowe, łożyskowe, sprężynowe i stale szybko tnące**	< 1 500
	P4	P4.1 Stale nierdzewne, ferrytyczne i martenzytyczne	
	P5	P5.1 Staliwo	
	P6	P6.1 Staliwo nierdzewne, ferrytyczne i martenzytyczne	
M	M1	M1.1 Stale nierdzewne, austenityczne	< 700
		M1.2 Stale nierdzewne, ferrytyczne/austenityczne (Duplex)	< 1 000
	M2	M2.1 Staliwo nierdzewne, austenityczne	< 700
	M3	M3.1 Staliwo nierdzewne, ferrytyczne/austenityczne (Duplex)	< 1 000
K	K1	K1.1 Żeliwo z grafitem płatkowym (żeliwo szare), GJL	< 300
		K2.1 Żeliwo sferoidalne, GJS	< 500
	K2	K2.2 Żeliwo sferoidalne, GJS	≤ 800
		K2.3 Żeliwo sferoidalne, GJS	> 800
	K3	K3.1 Żeliwo wermikularne, GJV, (żeliwo ciągliwe), GJL	< 500
		K3.2 Żeliwo wermikularne, GJV, (żeliwo ciągliwe), GJL	> 500

* Grupa materiałowa wg MAPAL

** Jeśli składniki stopu Cr, Mo, Ni, V, W wynoszą łącznie > 8%, należy wybrać następną w kolejności grupę materiałową MAPAL.

	Prędkość skrawania v_c [m/min]				Posuw f [mm] przy średnicy wiertła					
	Chłodzenie wewnętrzne	Chłodzenie zewnętrzne	Mgietka	Powietrze	4,00	5,50	7,50	10,50	14,50	20,00
	115	105	105		0,24	0,30	0,37	0,46	0,56	0,65
	105	85	85		0,30	0,37	0,46	0,58	0,70	0,81
	115	100	100		0,28	0,35	0,44	0,55	0,66	0,77
	80	70	70		0,24	0,29	0,36	0,44	0,53	0,61
	85	75	75		0,25	0,31	0,39	0,49	0,60	0,69
	70	65	65		0,21	0,26	0,33	0,41	0,49	0,56
	70	50	60		0,18	0,21	0,26	0,32	0,38	0,43
	115	100	100		0,28	0,35	0,44	0,55	0,66	0,77
	55	35	35		0,11	0,14	0,18	0,22	0,27	0,31
	140	100	100	100	0,34	0,45	0,58	0,75	0,92	1,08
	185	115	140	140	0,34	0,43	0,55	0,70	0,85	1,00
	115	85	85		0,30	0,38	0,48	0,61	0,74	0,86
	70	45	60		0,16	0,20	0,25	0,31	0,38	0,44
	105	90	90		0,32	0,41	0,52	0,65	0,79	0,92
	90	80	80		0,27	0,34	0,42	0,52	0,63	0,73

	Prędkość skrawania v_c [m/min]				Posuw f [mm] przy średnicy wiertła					
	Chłodzenie wewnętrzne	Chłodzenie zewnętrzne	Mgietka	Powietrze	3,00	4,50	6,50	9,50	14,00	20,00
	170	155	155		0,13	0,17	0,22	0,29	0,36	0,43
	155	130	130		0,16	0,21	0,28	0,36	0,45	0,54
	170	145	145		0,15	0,20	0,26	0,34	0,43	0,51
	120	100	100		0,13	0,17	0,21	0,27	0,34	0,40
	130	110	110		0,13	0,18	0,23	0,30	0,39	0,46
	100	95	95		0,12	0,15	0,20	0,25	0,32	0,37
	100	75	85		0,10	0,12	0,16	0,20	0,25	0,29
	100	75	85		0,09	0,12	0,16	0,20	0,25	0,30
	170	145	145		0,15	0,20	0,26	0,34	0,43	0,51
	100	75	85		0,09	0,12	0,16	0,20	0,25	0,30
	65	40	40		0,07	0,09	0,12	0,15	0,19	0,23
	60	35	35		0,06	0,08	0,10	0,13	0,17	0,20
	65	40	40		0,07	0,09	0,12	0,15	0,19	0,23
	60	35	35		0,06	0,08	0,10	0,13	0,17	0,20
	150	105	105	105	0,14	0,21	0,28	0,38	0,49	0,59
	200	125	150	150	0,14	0,20	0,27	0,36	0,46	0,54
	125	95	95		0,13	0,18	0,24	0,31	0,39	0,47
	75	50	65		0,09	0,12	0,15	0,19	0,24	0,28
	115	100	100		0,14	0,19	0,25	0,33	0,42	0,50
	100	90	90		0,12	0,16	0,21	0,27	0,34	0,40

Podane parametry skrawania to wartości orientacyjne.

Optymalne wartości dla danego przypadku obróbki należy ustalić w ramach próby lub podczas obróbki.

Zalecane parametry skrawania dla wiertła z węglika spiekanego

Posuw i prędkość skrawania

MEGA-180°-Drill | SCD231

MZG*		Materiał obrabiany	Wytrzymałość/twardość [N/mm ²] [HRC]
P	P1	P1.1 Stale konstrukcyjne, użytkowe i uszlachetnione, stale niestopowe	< 700
		P1.2 Stale konstrukcyjne, użytkowe i uszlachetnione, stale niestopowe	< 1 200
	P2	P2.1 Stale azotowane, użytkowe i uszlachetnione, stale stopowe	< 900
		P2.2 Stale azotowane, użytkowe i uszlachetnione, stale stopowe	< 1 400
	P3	P3.1 Stale narzędziowe, łożyskowe, sprężynowe i stale szybkoobrotowe**	< 800
		P3.2 Stale narzędziowe, łożyskowe, sprężynowe i stale szybkoobrotowe**	< 1 000
		P3.3 Stale narzędziowe, łożyskowe, sprężynowe i stale szybkoobrotowe**	< 1 500
	P5	P5.1 Staliwo	
K	K1	K1.1 Żeliwo z grafitem płatkowym (żeliwo szare), GJL	< 300
		K2.1 Żeliwo sferoidalne, GJS	< 500
	K2	K2.2 Żeliwo sferoidalne, GJS	≤ 800
		K2.3 Żeliwo sferoidalne, GJS	> 800
	K3	K3.1 Żeliwo wermikularne, GJV, (żeliwo ciągliwe), GJL	< 500
		K3.2 Żeliwo wermikularne, GJV, (żeliwo ciągliwe), GJL	> 500

ECU-Drill-Steel | SCD360, 361

MZG*		Materiał obrabiany	Wytrzymałość/twardość [N/mm ²] [HRC]
P	P1	P1.1 Stale konstrukcyjne, użytkowe i uszlachetnione, stale niestopowe	< 700
		P1.2 Stale konstrukcyjne, użytkowe i uszlachetnione, stale niestopowe	< 1 200
	P2	P2.1 Stale azotowane, użytkowe i uszlachetnione, stale stopowe	< 900
		P2.2 Stale azotowane, użytkowe i uszlachetnione, stale stopowe	< 1 400
	P3	P3.1 Stale narzędziowe, łożyskowe, sprężynowe i stale szybkoobrotowe**	< 800
		P3.2 Stale narzędziowe, łożyskowe, sprężynowe i stale szybkoobrotowe**	< 1 000
		P3.3 Stale narzędziowe, łożyskowe, sprężynowe i stale szybkoobrotowe**	< 1 500
	P4	P4.1 Stale nierdzewne, ferrytyczne i martenzytyczne	
	P5	P5.1 Staliwo	
	P6	P6.1 Staliwo nierdzewne, ferrytyczne i martenzytyczne	
K	K1	K1.1 Żeliwo z grafitem płatkowym (żeliwo szare), GJL	< 300
		K2.1 Żeliwo sferoidalne, GJS	< 500
	K2	K2.2 Żeliwo sferoidalne, GJS	≤ 800
		K2.3 Żeliwo sferoidalne, GJS	> 800
	K3	K3.1 Żeliwo wermikularne, GJV, (żeliwo ciągliwe), GJL	< 500
		K3.2 Żeliwo wermikularne, GJV, (żeliwo ciągliwe), GJL	> 500

* Grupa materiałowa wg MAPAL

** Jeśli składniki stopu Cr, Mo, Ni, V, W wynoszą łącznie > 8%, należy wybrać następną w kolejności grupę materiałową MAPAL.

	Prędkość skrawania v_c [m/min]				Posuw f [mm] przy średnicy wiertła					
	Chłodzenie wewnętrzne	Chłodzenie zewnętrzne	Mgietka	Powietrze	3,00	4,50	6,50	9,50	14,00	20,00
	80	70	70		0,07	0,09	0,12	0,16	0,20	0,24
	70	60	60		0,09	0,12	0,15	0,20	0,25	0,30
	80	70	70		0,08	0,11	0,14	0,19	0,24	0,28
	55	50	50		0,07	0,09	0,12	0,15	0,19	0,22
	60	50	50		0,07	0,10	0,13	0,17	0,21	0,25
	50	45	45		0,06	0,08	0,11	0,14	0,17	0,21
	50	35	40		0,05	0,07	0,09	0,11	0,14	0,16
	80	70	70		0,08	0,11	0,14	0,19	0,24	0,28
	95	70	70	70	0,09	0,14	0,19	0,25	0,33	0,39
	130	80	95	95	0,10	0,13	0,18	0,24	0,30	0,36
	80	60	60		0,09	0,12	0,16	0,21	0,26	0,31
	50	30	40		0,06	0,08	0,11	0,14	0,17	0,21
	70	65	65		0,09	0,13	0,17	0,22	0,28	0,33
	65	55	55		0,08	0,11	0,14	0,18	0,22	0,26

	Prędkość skrawania v_c [m/min]				Posuw f [mm] przy średnicy wiertła					
	Chłodzenie wewnętrzne	Chłodzenie zewnętrzne	Mgietka	Powietrze	1,00	1,82	3,31	6,03	10,99	20,00
	75	70	70		0,04	0,06	0,08	0,13	0,20	0,27
	70	55	55		0,05	0,07	0,11	0,16	0,24	0,33
	75	65	65		0,05	0,07	0,10	0,15	0,23	0,31
	55	45	45		0,05	0,06	0,09	0,13	0,18	0,25
	55	50	50		0,04	0,06	0,09	0,14	0,21	0,28
	45	40	40		0,04	0,05	0,08	0,12	0,17	0,23
	45	35	40		0,04	0,05	0,06	0,09	0,13	0,18
	45	35	40		0,03	0,04	0,06	0,09	0,14	0,19
	75	65	65		0,05	0,07	0,10	0,15	0,23	0,31
	45	35	40		0,03	0,04	0,06	0,09	0,14	0,19
	80	60	60	60	0,04	0,07	0,12	0,20	0,32	0,44
	110	70	80	80	0,05	0,07	0,12	0,19	0,30	0,41
	70	50	50		0,04	0,07	0,11	0,17	0,26	0,35
	40	25	35		0,04	0,05	0,08	0,12	0,17	0,23
	60	55	55		0,05	0,07	0,11	0,18	0,27	0,38
	55	50	50		0,05	0,07	0,10	0,15	0,22	0,30

Podane parametry skrawania to wartości orientacyjne.

Optymalne wartości dla danego przypadku obróbki należy ustalić w ramach próby lub podczas obróbki.

Zalecane parametry skrawania dla wiertła z węglika spiekanego

Posuw i prędkość skrawania

MEGA-Drill-Inox | SCD120, 121

MZG*		Materiał obrabiany	Wytrzymałość/twardość [N/mm ²] [HRC]
P	P1	P1.1 Stale konstrukcyjne, użytkowe i uszlachetnione, stale niestopowe	< 700
		P1.2 Stale konstrukcyjne, użytkowe i uszlachetnione, stale niestopowe	< 1 200
	P2	P2.1 Stale azotowane, użytkowe i uszlachetnione, stale stopowe	< 900
		P2.2 Stale azotowane, użytkowe i uszlachetnione, stale stopowe	< 1 400
	P3	P3.1 Stale narzędziowe, łożyskowe, sprężynowe i stale szybko tnące**	< 800
		P3.2 Stale narzędziowe, łożyskowe, sprężynowe i stale szybko tnące**	< 1 000
		P3.3 Stale narzędziowe, łożyskowe, sprężynowe i stale szybko tnące**	< 1 500
	P4	P4.1 Stale nierdzewne, ferrytyczne i martenzytyczne	
	P5	P5.1 Staliwo	
	P6	P6.1 Staliwo nierdzewne, ferrytyczne i martenzytyczne	
M	M1	M1.1 Stale nierdzewne, austenityczne	< 700
		M1.2 Stale nierdzewne, ferrytyczne/austenityczne (Duplex)	< 1 000
	M2	M2.1 Staliwo nierdzewne, austenityczne	< 700
		M3.1 Staliwo nierdzewne, ferrytyczne/austenityczne (Duplex)	< 1 000
K	K1	K1.1 Żeliwo z grafitem płatkowym (żeliwo szare), GJL	< 300
		K2.1 Żeliwo sferoidalne, GJS	< 500
	K2	K2.2 Żeliwo sferoidalne, GJS	≤ 800
		K2.3 Żeliwo sferoidalne, GJS	> 800
	K3	K3.1 Żeliwo wermikularne, GJV, (żeliwo ciągliwe), GJL	< 500
		K3.2 Żeliwo wermikularne, GJV, (żeliwo ciągliwe), GJL	> 500
N	N2	N2.1 Miedź, niestopowa i niskostopowa	< 300
		N2.2 Miedź, stopowa	> 300
	N2.3 Mosiądz, brąz, spiż	< 1 200	

MEGA-Speed-Drill-Inox | SCD411

MZG*		Materiał obrabiany	Wytrzymałość/twardość [N/mm ²] [HRC]
P	P1	P1.1 Stale konstrukcyjne, użytkowe i uszlachetnione, stale niestopowe	< 700
		P1.2 Stale konstrukcyjne, użytkowe i uszlachetnione, stale niestopowe	< 1 200
	P2	P2.1 Stale azotowane, użytkowe i uszlachetnione, stale stopowe	< 900
		P2.2 Stale azotowane, użytkowe i uszlachetnione, stale stopowe	< 1 400
	P3	P3.1 Stale narzędziowe, łożyskowe, sprężynowe i stale szybko tnące**	< 800
		P3.2 Stale narzędziowe, łożyskowe, sprężynowe i stale szybko tnące**	< 1 000
		P3.3 Stale narzędziowe, łożyskowe, sprężynowe i stale szybko tnące**	< 1 500
	P4	P4.1 Stale nierdzewne, ferrytyczne i martenzytyczne	
	P5	P5.1 Staliwo	
	P6	P6.1 Staliwo nierdzewne, ferrytyczne i martenzytyczne	
M	M1	M1.1 Stale nierdzewne, austenityczne	< 700
		M1.2 Stale nierdzewne, ferrytyczne/austenityczne (Duplex)	< 1 000
	M2	M2.1 Staliwo nierdzewne, austenityczne	< 700
		M3.1 Staliwo nierdzewne, ferrytyczne/austenityczne (Duplex)	< 1 000
S	S1	S1.1 Tytan, stopy tytanu	< 400
		S2.1 Tytan, stopy tytanu	< 1 200
	S2	S2.2 Tytan, stopy tytanu	> 1 200
		S3.1 Nikiel, niestopowy i stopowy	< 900
	S3	S3.2 Nikiel, niestopowy i stopowy	> 900
		S4.1 Nadstop o wysokiej odporności termicznej na bazie Ni, Co i Fe	
	S5	S5.1 Stopy wolframu i molibdenu	

* Grupa materiałowa wg MAPAL

** Jeśli składniki stopu Cr, Mo, Ni, V, W wynoszą łącznie > 8%, należy wybrać następną w kolejności grupę materiałową MAPAL.

	Prędkość skrawania v_c [m/min]				Posuw f [mm] przy średnicy wiertła					
	Chłodzenie wewnętrzne	Chłodzenie zewnętrzne	Mgietka	Powietrze	3,00	4,50	6,50	9,50	14,00	20,00
	100	90	90		0,07	0,09	0,12	0,16	0,20	0,24
	90	75	75		0,09	0,12	0,15	0,20	0,25	0,30
	100	85	85		0,08	0,11	0,14	0,19	0,24	0,28
	70	60	60		0,07	0,09	0,12	0,15	0,19	0,22
	75	65	65		0,07	0,10	0,13	0,17	0,21	0,25
	60	55	55		0,06	0,08	0,11	0,14	0,17	0,21
	60	45	50		0,05	0,07	0,09	0,11	0,14	0,16
	60	45	50		0,05	0,07	0,09	0,11	0,14	0,17
	100	85	85		0,08	0,11	0,14	0,19	0,24	0,28
	60	45	50		0,05	0,07	0,09	0,11	0,14	0,17
	55	35	35		0,06	0,08	0,11	0,14	0,18	0,21
	50	30	30		0,05	0,07	0,09	0,12	0,15	0,18
	55	35	35		0,06	0,08	0,11	0,14	0,18	0,21
	50	30	30		0,05	0,07	0,09	0,12	0,15	0,18
	120	85	85	85	0,12	0,17	0,24	0,32	0,41	0,49
	160	100	120	120	0,12	0,17	0,22	0,30	0,38	0,45
	100	75	75		0,11	0,15	0,20	0,26	0,33	0,39
	60	40	50		0,08	0,10	0,13	0,17	0,22	0,26
	90	80	80		0,12	0,16	0,21	0,28	0,35	0,42
	80	70	70		0,10	0,13	0,17	0,22	0,28	0,33
	140	100			0,09	0,12	0,15	0,20	0,25	0,30
	120	90			0,11	0,15	0,20	0,26	0,33	0,39
	200	160	160	120	0,12	0,17	0,24	0,32	0,41	0,49

	Prędkość skrawania v_c [m/min]				Posuw f [mm] przy średnicy wiertła					
	Chłodzenie wewnętrzne	Chłodzenie zewnętrzne	Mgietka	Powietrze	3,00	4,50	6,50	9,50	14,00	20,00
	150	135	135		0,09	0,12	0,15	0,20	0,25	0,30
	135	115	115		0,11	0,15	0,19	0,25	0,31	0,37
	150	130	130		0,10	0,14	0,18	0,23	0,30	0,35
	105	90	90		0,09	0,12	0,15	0,19	0,24	0,28
	115	100	100		0,09	0,12	0,16	0,21	0,27	0,32
	90	85	85		0,08	0,10	0,13	0,17	0,22	0,26
	90	70	75		0,07	0,09	0,11	0,14	0,17	0,20
	70	55	60		0,06	0,08	0,11	0,14	0,18	0,21
	150	130	130		0,10	0,14	0,18	0,23	0,30	0,35
	70	55	60		0,06	0,08	0,11	0,14	0,18	0,21
	80	50	50		0,08	0,10	0,13	0,17	0,22	0,26
	75	45	45		0,07	0,09	0,11	0,15	0,19	0,22
	80	50	50		0,08	0,10	0,13	0,17	0,22	0,26
	75	45	45		0,07	0,09	0,11	0,15	0,19	0,22
					0,07	0,10	0,13	0,17	0,21	0,25
	35	25			0,06	0,08	0,11	0,14	0,18	0,21
	30	20			0,05	0,07	0,09	0,12	0,15	0,18
	25	20			0,04	0,06	0,07	0,10	0,12	0,14
	20	10			0,05	0,07	0,09	0,12	0,15	0,18
	20	10			0,04	0,06	0,07	0,10	0,12	0,14
	20	10			0,04	0,06	0,07	0,10	0,12	0,14

Podane parametry skrawania to wartości orientacyjne.

Optymalne wartości dla danego przypadku obróbki należy ustalić w ramach próby lub podczas obróbki.

Zalecane parametry skrawania dla wiertła z węglika spiekanego

Posuw i prędkość skrawania

MEGA-Speed-Drill-Iron | SCD421

MZG*	Materiał obrabiany		Wytrzymałość/twardość [N/mm ²] [HRC]
K	K1	K1.1 Żeliwo z grafitem płatkowym (żeliwo szare), GJL	< 300
		K2.1 Żeliwo sferoidalne, GJS	< 500
	K2	K2.2 Żeliwo sferoidalne, GJS	≤ 800
		K2.3 Żeliwo sferoidalne, GJS	> 800
	K3	K3.1 Żeliwo wermikularne, GJV, (żeliwo ciągliwe), GJL	< 500
		K3.2 Żeliwo wermikularne, GJV, (żeliwo ciągliwe), GJL	> 500

MEGA-Drill-Alu | SCD131

MZG*	Materiał obrabiany		Wytrzymałość/twardość [N/mm ²] [HRC]
N	N1	N1.1 Aluminium, niestopowe i stopowe < 3 % Si	
		N1.2 Aluminium, stopowe ≤ 7 % Si	
		N1.3 Aluminium, stopowe > 7-12 % Si	
		N1.4 Aluminium, stopowe > 12 % Si	
	N2	N2.1 Miedź, niestopowa i niskostopowa	< 300
		N2.2 Miedź, stopowa	> 300
N2.3 Mosiądz, brąz, spiż		< 1 200	

MEGA-Drill-Composite-MD | SCD250

MZG*	Materiał obrabiany		Wytrzymałość/twardość [N/mm ²] [HRC]
N	N3	N3.1 Grafit, > 8 μm	
		N3.2 Grafit, ≤ 8 μm	
C	C1	C1.1 Matryca z tworzywa sztucznego, wzmacnianego włóknem aramidowym (AFK)	
		C1.2 Matryca z tworzywa sztucznego (duroplastycznego), CFK/GFK	
		C1.3 Matryca z tworzywa sztucznego (termoplastycznego), CFK/GFK	
	C2	C2.1 Matryca węglowa, wzmacniana włóknem węglowym (CFC)	
		C3.1 Matryca metalowa (MMC)	
	C4	C4.1 Konstrukcja typu sandwich, rdzeń w formie plastra miodu (Honeycomb)	
		C4.2 Konstrukcja typu sandwich, rdzeń piankowy	

MEGA-Drill-Composite-UDX | SCD270, 271

MZG*	Materiał obrabiany		Wytrzymałość/twardość [N/mm ²] [HRC]
C	C1	C1.1 Matryca z tworzywa sztucznego, wzmacnianego włóknem aramidowym (AFK)	
		C1.2 Matryca z tworzywa sztucznego (duroplastycznego), CFK/GFK	
		C1.3 Matryca z tworzywa sztucznego (termoplastycznego), CFK/GFK	
	C2.1 Matryca węglowa, wzmacniana włóknem węglowym (CFC)		

* Grupa materiałowa wg MAPAL

	Prędkość skrawania v_c [m/min]				Posuw f [mm] przy średnicy wiertła					
	Chłodzenie wewnętrzne	Chłodzenie zewnętrzne	Mgiełka	Powietrze	3,00	4,50	6,50	9,50	14,00	20,00
	170	120	120	120	0,15	0,21	0,29	0,40	0,51	0,61
	225	140	170	170	0,15	0,21	0,28	0,37	0,48	0,57
	140	105	105		0,14	0,19	0,25	0,32	0,41	0,49
	85	55	70		0,10	0,13	0,17	0,22	0,27	0,32
	125	110	110		0,15	0,20	0,26	0,35	0,44	0,52
	110	100	100		0,13	0,17	0,22	0,28	0,35	0,41

	Prędkość skrawania v_c [m/min]				Posuw f [mm] przy średnicy wiertła					
	Chłodzenie wewnętrzne	Chłodzenie zewnętrzne	Mgiełka	Powietrze	3,00	4,50	6,50	9,50	14,00	20,00
	300	200	250		0,09	0,12	0,15	0,20	0,25	0,30
	250	180	200		0,11	0,15	0,20	0,26	0,33	0,39
	220	150	180		0,11	0,15	0,20	0,26	0,33	0,39
	180	120	150		0,11	0,15	0,20	0,26	0,33	0,39
	140	100			0,09	0,12	0,15	0,20	0,25	0,30
	120	90			0,11	0,15	0,20	0,26	0,33	0,39
	200	160	160	120	0,09	0,14	0,19	0,25	0,33	0,39

	Prędkość skrawania v_c [m/min]				Posuw f [mm] przy średnicy wiertła					
	Chłodzenie wewnętrzne	Chłodzenie zewnętrzne	Mgiełka	Powietrze	3,00	4,00	5,50	7,50	10,00	12,00
				200	0,07	0,09	0,11	0,14	0,16	0,18
				200	0,07	0,09	0,11	0,14	0,16	0,18
				90	0,04	0,04	0,05	0,06	0,07	0,08
				75	0,04	0,04	0,05	0,06	0,07	0,08
				75	0,04	0,04	0,05	0,06	0,07	0,08
				400	0,04	0,04	0,05	0,06	0,07	0,08
				400	0,04	0,04	0,05	0,06	0,07	0,08

	Prędkość skrawania v_c [m/min]				Posuw f [mm] przy średnicy wiertła					
	Chłodzenie wewnętrzne	Chłodzenie zewnętrzne	Mgiełka	Powietrze	3,00	4,00	5,50	7,50	10,00	12,00
				90	0,04	0,04	0,05	0,06	0,07	0,08
				75	0,04	0,04	0,05	0,06	0,07	0,08
				75	0,04	0,04	0,05	0,06	0,07	0,08

Podane parametry skrawania to wartości orientacyjne.

Optymalne wartości dla danego przypadku obróbki należy ustalić w ramach próby lub podczas obróbki.

Zalecane parametry skrawania dla wiertła z węglika spiekanego

Posuw i prędkość skrawania

MEGA-180°-Drill-Alu | SCD241

MZG*		Materiał obrabiany	Wytrzymałość/twardość [N/mm ²] [HRC]
N	N1	N1.1 Aluminium, niestopowe i stopowe < 3 % Si	
		N1.2 Aluminium, stopowe ≤ 7 % Si	
		N1.3 Aluminium, stopowe > 7-12 % Si	
		N1.4 Aluminium, stopowe > 12 % Si	
N	N2	N2.1 Miedź, niestopowa i niskostopowa	< 300
		N2.2 Miedź, stopowa	> 300
		N2.3 Mosiądz, brąz, spiż	< 1 200

ECU-G-Drill | SCD211

MZG*		Materiał obrabiany	Wytrzymałość/twardość [N/mm ²] [HRC]
K	K1	K1.1 Żeliwo z grafitem płatkowym (żeliwo szare), GJL	< 300
		K2.1 Żeliwo sferoidalne, GJS	< 500
		K2.2 Żeliwo sferoidalne, GJS	≤ 800
		K2.3 Żeliwo sferoidalne, GJS	> 800
N	N1	N1.1 Aluminium, niestopowe i stopowe < 3 % Si	
		N1.2 Aluminium, stopowe ≤ 7 % Si	
		N1.3 Aluminium, stopowe > 7-12 % Si	
		N1.4 Aluminium, stopowe > 12 % Si	
N	N2	N2.1 Miedź, niestopowa i niskostopowa	< 300
		N2.2 Miedź, stopowa	> 300
		N2.3 Mosiądz, brąz, spiż	< 1 200

* Grupa materiałowa wg MAPAL

	Prędkość skrawania v_c [m/min]				Posuw f [mm] przy średnicy wiertła					
	Chłodzenie wewnętrzne	Chłodzenie zewnętrzne	Mgietka	Powietrze	3,00	4,50	6,50	9,50	14,00	20,00
	240	160	200		0,07	0,09	0,12	0,16	0,20	0,24
	200	145	160		0,09	0,12	0,16	0,21	0,26	0,31
	175	120	145		0,09	0,12	0,16	0,21	0,26	0,31
	145	95	120		0,09	0,12	0,16	0,21	0,26	0,31
	110	80			0,07	0,09	0,12	0,16	0,20	0,24
	95	70			0,09	0,12	0,16	0,21	0,26	0,31
	160	130	130	95	0,09	0,14	0,19	0,25	0,33	0,39

	Prędkość skrawania v_c [m/min]				Posuw f [mm] przy średnicy wiertła					
	Chłodzenie wewnętrzne	Chłodzenie zewnętrzne	Mgietka	Powietrze	3,00	4,50	6,50	9,50	14,00	20,00
	90	65	65	65	0,08	0,12	0,16	0,22	0,29	0,34
	120	75	90	90	0,08	0,12	0,16	0,21	0,27	0,32
	75	55	55		0,08	0,10	0,14	0,18	0,23	0,27
	215	155	170		0,08	0,10	0,14	0,18	0,23	0,27
	185	130	155		0,08	0,10	0,14	0,18	0,23	0,27
	155	100	130		0,08	0,10	0,14	0,18	0,23	0,27
	160	130	130	95	0,08	0,12	0,16	0,22	0,29	0,34

Podane parametry skrawania to wartości orientacyjne.

Optymalne wartości dla danego przypadku obróbki należy ustalić w ramach próby lub podczas obróbki.

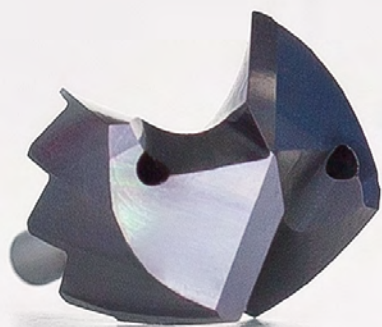

WIERCENIE W PEŁNYM MATERIALE SYSTEMEM Z WYMIENNĄ GŁOWICĄ

Wiertła z płytkami skrawającymi QTD

Technologia	184
Typ 01 – Steel	186
Typ 05 – Steel-Pyramid	188
Typ 10 – Uni, kształt EK	190
Typ 02 – Inox	191
Typ 04 – Iron	193
Typ 03 – Alu	194
Uchwyty na płytki skrawające QTS	195
Osprzęt i części zamienne	199
Zalecane parametry skrawania	200

Wiertła z wymienną głowicą TTD

Technologia	204
Typ 01 – Uni-Plus	206
Typ 04 – Steel	207
Typ 02 – Inox	209
Typ 05 – Iron	211
Typ 03 – Alu	212
Uchwyt wymiennej głowicy TTS	213
Osprzęt i części zamienne	222
Zalecane parametry skrawania	224

Wiertła z wymienną głowicą TTD-Tritan

Technologia	228
Typ 01 – Uni	230
Uchwyt wymiennej głowicy TTS-300	231
Osprzęt i części zamienne	234
Zalecane parametry skrawania	236

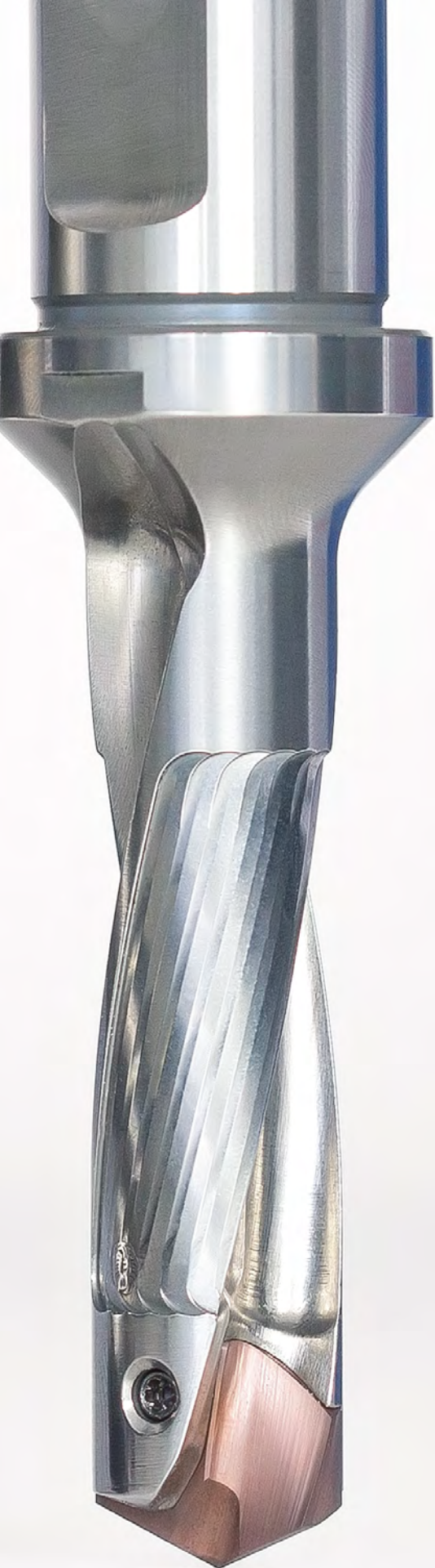



WIERTŁA Z PŁYTKAMI SKRAWAJĄCYMI QTD

Pewne mocowanie płytki skrawającej, łatwa obsługa

Dzięki najnowocześniejszej technologii produkcji w zakresie średnicy od 8 do 50 mm

Wiertło z płytkami skrawającymi QTD dla zakresu średnic od średnich do dużych charakteryzuje się bardzo dobrym łamaniem wiórów i ich pewnym usuwaniem. Możliwa jest wielokrotna wymiana płytek skrawających w uchwycie, ponieważ w narzędziu nie dochodzi do wypłukiwania materiału uchwytu zasadniczego. System mocowania płytki jest ponadto wyjątkowo łatwy w obsłudze i skuteczny. Składa się on ze śruby wkręcanej w poprzek płytki skrawającej i stabilnie mocującej ją wstępnie w chwycie. Mocowanie płytki skrawającej w chwycie jest wyjątkowo stabilne, co pozwala na uzyskanie wysokich parametrów skrawania i jakości otworów.

Produkcja addytywna umożliwia uzyskanie optymalnej konstrukcji kanałów doprowadzających chłodziwo i średnic od 9 mm

Produkcja addytywna jest wykorzystywana również do uzyskania średnic poniżej 13 mm. Proces ten pozwala na produkcję korpusów w zakresie średnicy od 8 do 13 mm ze spiralnymi kanałami doprowadzającymi chłodziwo. Na przykład wiertło QTD z kanałami spiralnymi osiąga 100-procentowy wzrost przepływu chłodziwa w porównaniu z centralnym prowadzeniem chłodziwa z elementami kierującymi, zwłaszcza dzięki temu, że kształt profili kanałów chłodzących odbiega od kołowego.

Cechy charakterystyczne narzędzia



1 Chwyt zgodny z ISO 9766

2 Powierzchnia czołowa chwytu

3 Oznaczenie maksymalnej głębokości wiercenia

4 Wybranie materiału
– dla optymalnej ewakuacji wiórów

5 Optymalne przenoszenie siły
– Dzięki osadzonej płytce skrawającej

6 Chwyt ze stali hartowanej z chwytym cylindrycznym

7 Stabilne mocowanie TORX PLUS®

8 Pryzmatyczne gniazdo płytki skrawającej
– Do optymalnego centrowania płytki skrawającej

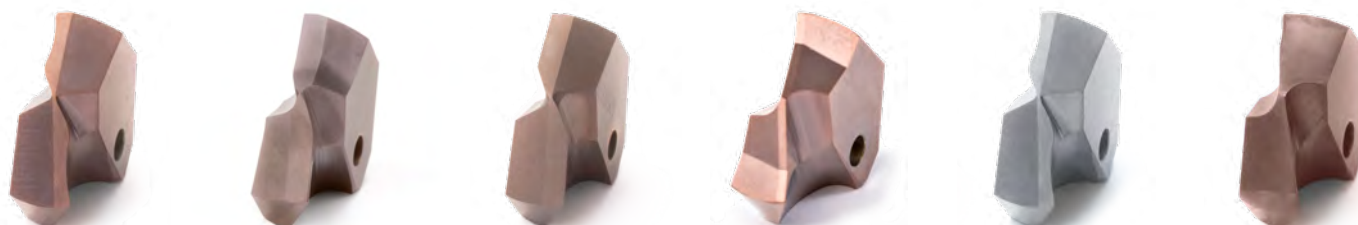

W SKRÓCIE

- Wysoka dostępność w magazynie
- Zakres średnic od 9 do 50 mm
- Program uchwytów 1,5 | 3 | 5 | 8 i 12xD
- Płytki skrawające do stali, stali nierdzewnej, aluminium i żeliwa
- Z chłodzeniem wewnętrznym
- Specjalna obróbka powierzchni
- Łatwa obsługa, wymiana płytek skrawających w maszynie

WŁAŚCIWOŚCI UŻYTKOWE

- Parametry takie same, jak w przypadku wiertel z węgliku spiekanego
- niska wartość bicia
- Stabilny kołnierz do przenoszenia dużych sił osiowych
- Pewne mocowanie płytki skrawającej dzięki śrubie TORX PLUS®
- System o wysokiej niezawodności

ZALETY

- Optymalizacja kosztów
- Najwyższe osiągi
- System montażu płytki skrawającej uniemożliwiający pomylenie elementu
- Optymalne kształtowanie i ewakuacja wiórów
- Jeden chwyt do wszystkich geometrii wiertel
- Możliwość wielokrotnego zastosowania dzięki przeciwdziałaniu wypukliwaniu korpusu przez wióry

Płytki skrawające QTD

Z węgla spiekane, wewnętrzne doprowadzenie chłodziwa
Typ 01 – Steel

Wersja:

Średnica wiertła: 9,00 - 50,00 mm
Tolerancja otworu: $\geq IT 10$
Materiał skrawający: HP240
Liczba ostrzy: 2
Liczba tyśinek: 2
Kąt wierzchołkowy: 135°

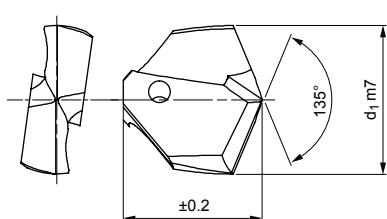

Magazynowa seria preferowana

d ₁ od 9,00 do 15,50			
d ₁ m7	Wielkość uchwytu D	Specyfikacja	Nr materiałowy
9,00	9	QTD-2F01-0900-HP240	30615635
9,50	9,5	QTD-2F01-0950-HP240	30615636
10,00	10	QTD-2F01-1000-HP240	30615638
10,20	10	QTD-2F01-1020-HP240	30646024
10,50	10,5	QTD-2F01-1050-HP240	30615639
10,70	10,5	QTD-2F01-1070-HP240	30615640
11,00	11	QTD-2F01-1100-HP240	30615641
11,50	11,5	QTD-2F01-1150-HP240	30615642
12,00	12	QTD-2F01-1200-HP240	30615644
12,50	12,5	QTD-2F01-1250-HP240	30615645
12,70	12,5	QTD-2F01-1270-HP240	30615646
12,80	12,5	QTD-2F01-1280-HP240	30646043
13,00	13	QTD-2F01-1300-HP240	30572990
13,10	13	QTD-2F01-1310-HP240	30646045
13,30	13	QTD-2F01-1330-HP240	30646047
13,40	13	QTD-2F01-1340-HP240	30646048
13,50	13,5	QTD-2F01-1350-HP240	30572991
13,80	13,5	QTD-2F01-1380-HP240	30646050
13,90	13,5	QTD-2F01-1390-HP240	30646051
14,00	14	QTD-2F01-1400-HP240	30572993
14,10	14	QTD-2F01-1410-HP240	30646052
14,20	14	QTD-2F01-1420-HP240	30646053
14,30	14	QTD-2F01-1430-HP240	30646055
14,50	14,5	QTD-2F01-1450-HP240	30572994
14,60	14,5	QTD-2F01-1460-HP240	30646057
14,70	14,5	QTD-2F01-1470-HP240	30572995
14,80	14,5	QTD-2F01-1480-HP240	30646058
14,90	14,5	QTD-2F01-1490-HP240	30646059
15,00	15	QTD-2F01-1500-HP240	30572997
15,10	15	QTD-2F01-1510-HP240	30646060
15,20	15	QTD-2F01-1520-HP240	30646061
15,25	15	QTD-2F01-1525-HP240	30572998
15,50	15	QTD-2F01-1550-HP240	30572999

d ₁ od 15,70 do 19,50			
d ₁ m7	Wielkość uchwytu D	Specyfikacja	Nr materiałowy
15,70	15	QTD-2F01-1570-HP240	30573000
15,80	15	QTD-2F01-1580-HP240	30646066
15,90	15	QTD-2F01-1590-HP240	30646068
16,00	16	QTD-2F01-1600-HP240	30573001
16,10	16	QTD-2F01-1610-HP240	30573003
16,20	16	QTD-2F01-1620-HP240	30646069
16,25	16	QTD-2F01-1625-HP240	30573004
16,30	16	QTD-2F01-1630-HP240	30610882
16,40	16	QTD-2F01-1640-HP240	30646071
16,50	16	QTD-2F01-1650-HP240	30573005
16,60	16	QTD-2F01-1660-HP240	30646072
16,70	16	QTD-2F01-1670-HP240	30573006
16,80	16	QTD-2F01-1680-HP240	30646074
16,90	16	QTD-2F01-1690-HP240	30646075
17,00	17	QTD-2F01-1700-HP240	30573009
17,10	17	QTD-2F01-1710-HP240	30646076
17,20	17	QTD-2F01-1720-HP240	30646077
17,30	17	QTD-2F01-1730-HP240	30646078
17,40	17	QTD-2F01-1740-HP240	30646079
17,50	17	QTD-2F01-1750-HP240	30573010
17,60	17	QTD-2F01-1760-HP240	30646081
17,70	17	QTD-2F01-1770-HP240	30573011
17,80	17	QTD-2F01-1780-HP240	30646082
17,90	17	QTD-2F01-1790-HP240	30646083
18,00	18	QTD-2F01-1800-HP240	30573012
18,10	18	QTD-2F01-1810-HP240	30646084
18,50	18	QTD-2F01-1850-HP240	30573014
18,60	18	QTD-2F01-1860-HP240	30646088
18,70	18	QTD-2F01-1870-HP240	30573015
18,80	18	QTD-2F01-1880-HP240	30646089
18,90	18	QTD-2F01-1890-HP240	30646090
19,00	19	QTD-2F01-1900-HP240	30573016
19,50	19	QTD-2F01-1905-HP240	30646091

Płytki QTD do wiercenia z węgla spiekane, wewnętrzne doprowadzenie chłodziwa – typ O1

d ₁ od 19,10 do 24,70				d ₁ od 24,75 do 42,60			
d ₁ m7	Wielkość uchwytu D	Specyfikacja	Nr materiałowy	d ₁ m7	Wielkość uchwytu D	Specyfikacja	Nr materiałowy
19,10	19	QTD-2F01-1910-HP240	30646092	24,75	24	QTD-2F01-2475-HP240	30573046
19,20	19	QTD-2F01-1920-HP240	30573017	24,80	24	QTD-2F01-2480-HP240	30660662
19,25	19	QTD-2F01-1925-HP240	30573018	25,00	25	QTD-2F01-2500-HP240	30573047
19,30	19	QTD-2F01-1930-HP240	30646094	25,40	25	QTD-2F01-2540-HP240	30573048
19,50	19	QTD-2F01-1950-HP240	30573020	25,50	25	QTD-2F01-2550-HP240	30573049
19,60	19	QTD-2F01-1960-HP240	30646095	25,70	25	QTD-2F01-2570-HP240	30573050
19,70	19	QTD-2F01-1970-HP240	30573021	25,80	25	QTD-2F01-2580-HP240	30584730
19,75	19	QTD-2F01-1975-HP240	30573022	26,00	26	QTD-2F01-2600-HP240	30573051
19,80	19	QTD-2F01-1980-HP240	30646096	26,50	26	QTD-2F01-2650-HP240	30573052
19,90	19	QTD-2F01-1990-HP240	30646097	27,00	27	QTD-2F01-2700-HP240	30573053
20,00	20	QTD-2F01-2000-HP240	30573023	27,50	27	QTD-2F01-2750-HP240	30573054
20,40	20	QTD-2F01-2040-HP240	30573024	27,75	27	QTD-2F01-2775-HP240	30573055
20,50	20	QTD-2F01-2050-HP240	30573025	28,00	28	QTD-2F01-2800-HP240	30573056
20,70	20	QTD-2F01-2070-HP240	30573026	28,50	28	QTD-2F01-2850-HP240	30573058
20,75	20	QTD-2F01-2075-HP240	30573027	29,00	29	QTD-2F01-2900-HP240	30573059
21,00	21	QTD-2F01-2100-HP240	30573028	29,50	29	QTD-2F01-2950-HP240	30573060
21,50	21	QTD-2F01-2150-HP240	30573029	29,80	29	QTD-2F01-2980-HP240	30728319
21,70	21	QTD-2F01-2170-HP240	30573030	30,00	30	QTD-2F01-3000-HP240	30573062
22,00	22	QTD-2F01-2200-HP240	30573031	30,25	30	QTD-2F01-3025-HP240	30573063
22,25	22	QTD-2F01-2225-HP240	30573032	30,50	30	QTD-2F01-3050-HP240	30573064
22,50	22	QTD-2F01-2250-HP240	30573034	31,00	31	QTD-2F01-3100-HP240	30573066
22,70	22	QTD-2F01-2270-HP240	30573035	31,50	31	QTD-2F01-3150-HP240	30573067
22,75	22	QTD-2F01-2275-HP240	30573036	32,00	32	QTD-2F01-3200-HP240	30573068
23,00	23	QTD-2F01-2300-HP240	30573037	33,00	33	QTD-2F01-3300-HP240	30649656
23,25	23	QTD-2F01-2325-HP240	30573038	34,00	34	QTD-2F01-3400-HP240	30649657
23,50	23	QTD-2F01-2350-HP240	30573039	35,00	35	QTD-2F01-3500-HP240	30649658
23,75	23	QTD-2F01-2375-HP240	30573042	36,00	36	QTD-2F01-3600-HP240	30649659
24,00	24	QTD-2F01-2400-HP240	30573043	37,00	37	QTD-2F01-3700-HP240	30649660
24,30	24	QTD-2F01-2430-HP240	30646105	38,00	37	QTD-2F01-3800-HP240	30649661
24,50	24	QTD-2F01-2450-HP240	30573044	40,00	39	QTD-2F01-4000-HP240	30657233
24,70	24	QTD-2F01-2470-HP240	30573045	42,00	41	QTD-2F01-4200-HP240	30657235

Możliwość konfiguracji parametrów



Średnica:
możliwość wyboru średnicy w krokach co 0,01 mm

Specyfikacja:
QTD-2F01-[średnica]-HP240

Przykład:
QTD-2F01-0901-HP240

Średnica narzędzia d₁ = 9,01 mm

Wymiary typoszeregu z możliwością konfiguracji parametrów

d ₁ min.	d ₁ maks.
9,00	50,00

Wymiary podano w mm.

Zalecane parametry skrawania – patrz koniec rozdziału.

Wersje specjalne i inne powłoki wg zapytania ofertowego.

Płytki skrawające QTD

Z węgla spiekane, wewnętrzne doprowadzenie chłodziwa
Typ 05 – Steel-Pyramid

Wersja:

Średnica wiertła:	14,00 - 32,00 mm
Tolerancja otworu:	≥ IT 10
Materiał skrawający:	HP605
Liczba ostrzy:	2
Liczba łysinek:	2
Kąt wierzchołkowy:	165°

Zastosowanie:

Do obróbki ze szczególnymi wymaganiami pod względem centrowania narzędzia (np. elementy cienkościennie, niestabilne warunki obróbki).

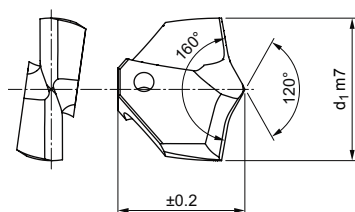

Magazynowa seria preferowana

Wymiary		Specyfikacja	Nr materiałowy
d ₁ m7	Wielkość uchwytu D		
14,00	14	QTD-2F05-1400-HP605	31126352
15,00	15	QTD-2F05-1500-HP605	31126356
16,00	16	QTD-2F05-1600-HP605	31126361
16,50	16	QTD-2F05-1650-HP605	31126364
17,50	17	QTD-2F05-1750-HP605	31126366
18,00	18	QTD-2F05-1800-HP605	31126368
18,50	18	QTD-2F05-1850-HP605	31126369
19,27	19	QTD-2F05-1927-HP605	31208007
19,80	19	QTD-2F05-1980-HP605	31126372
20,00	20	QTD-2F05-2000-HP605	31126373
20,50	20	QTD-2F05-2050-HP605	31126374
21,00	21	QTD-2F05-2100-HP605	31126375
21,50	21	QTD-2F05-2150-HP605	31126376
22,00	22	QTD-2F05-2200-HP605	31126377
23,00	23	QTD-2F05-2300-HP605	31126379
24,00	24	QTD-2F05-2400-HP605	31126380
25,00	25	QTD-2F05-2500-HP605	31126382
26,00	26	QTD-2F05-2600-HP605	31126384
26,50	26	QTD-2F05-2650-HP605	31126385
27,00	27	QTD-2F05-2700-HP605	31126386
28,00	28	QTD-2F05-2800-HP605	31126387
29,00	29	QTD-2F05-2900-HP605	31126388
30,00	30	QTD-2F05-3000-HP605	31126389
32,00	32	QTD-2F05-3200-HP605	31126391

Możliwość konfiguracji parametrów



Średnica:
możliwość wyboru średnicy w krokach co 0,01 mm

Specyfikacja:
QTD-2F01-[średnica]-HP240

Wymiary podano w mm.

Zalecane parametry skrawania - patrz koniec rozdziału.

Wersje specjalne i inne powłoki wg zapytania ofertowego.

Wymiary typoszerzemu z możliwością konfiguracji parametrów

d ₁ min.	d ₁ maks.
14,00	32,00

Przykład:

QTD-2F01-1401-HP240

Średnica narzędzia d₁ = 14,01 mm

Próba eksploatacyjna

Obróbka blach, wymienników ciepła / blach kotłowych, dźwigarów stalowych (T, U, ...).

Szczególnie odpowiednie do obróbki ze szczególnymi wymaganiami pod względem centrowania narzędzia oraz do elementów cienkościennych i niestabilnych warunków obróbki.

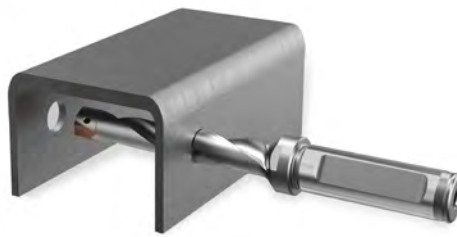
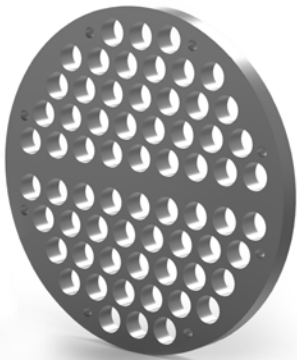

Dane dotyczące obróbki

Narzędzie:	ø 18 mm 5xD
Oprawka narzędziowa:	Oprawka mechaniczna
Chłodzenie:	Chłodzenie wewnętrzne, mgiełka
IB [mm]:	90
vc [m/min]:	63
n [min ⁻¹]:	1 115
f [mm]:	0,3
vf [mm/min]:	334

Liczba otworów

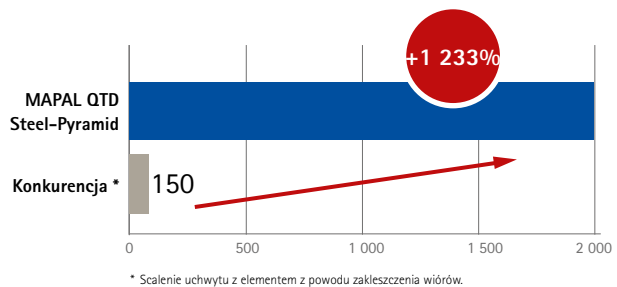

Płytki skrawające QTD

Z węgla spiekane,
Typ 10 – Uni, kształt EK

Wersja:

Średnica wiertła:	10,00 - 33,00 mm
Tolerancja otworu:	≥ IT 10
Materiał skrawający:	HP240
Liczba ostrzy:	2
Liczba tyśnek:	2
Kąt wierzchołkowy:	142°
Cechy szczególne:	Kształt EK Ostrze 180°, faza ochronna 0,5 mm

Zastosowanie:

Do otworów przelotowych pod śruby wg DIN ISO 273 i pogłębień wg DIN 74, arkusz 2 kształt H, J i K, wersja średnia.
Do śrub wg DIN 912, 6912 i 7984, ISO 1207 (DIN 84).

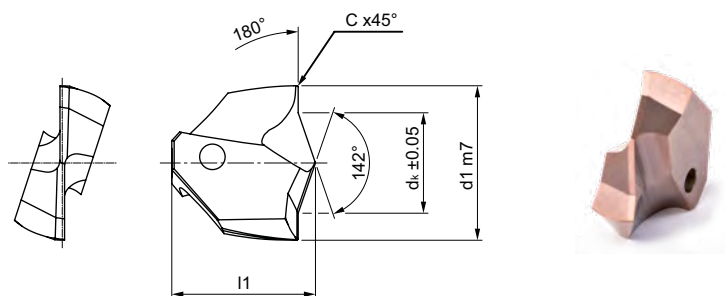

Magazynowa seria preferowana

Wymiary			Do śrub z łbem walcowym DIN	Odpowiednie do Ø Otwór przelotowy	Specyfikacja	Nr materiałowy
d ₁ m7	d _k ±0,05	Wielkość uchwytu D				
10,00	6,50	10	M5	5,5	QTD-2F10-1000-HP240	30868435
11,00	7,60	11	M6	6,6	QTD-2F10-1100-HP240	30868436
15,00	10,00	15	M8	9	QTD-2F10-1500-HP240	30868437
18,00	11,00	18	M10	11	QTD-2F10-1800-HP240	30868438
20,00	14,50	20	M12	13,5	QTD-2F10-2000-HP240	30868439
24,00	16,50	24	M14	15	QTD-2F10-2400-HP240	30868440
26,00	18,50	26	M16	17	QTD-2F10-2600-HP240	30868441
30,00	20,50	30	M18	19	QTD-2F10-3000-HP240	30868442
33,00	23,00	33	M20	21	QTD-2F10-3300-HP240	30868443

Wskazówki dotyczące zastosowania:

Wykonanie otworu przelotowego na śrubę z pogłębieniem dla śrub z łbem cylindrycznym wg DIN (w przykładzie: M12)

1. Krok:

Pogłębienie za pomocą wiertła QTD typ 10, kształt EK (w przykładzie: średnica 20 mm)

2. Krok:

Wiercenie za pomocą wiertła (w przykładzie: średnica 13,5 mm)

Wynik:

Otwór przelotowy pod śrubę z pogłębieniem i fazą – śruba z łbem cylindrycznym M12

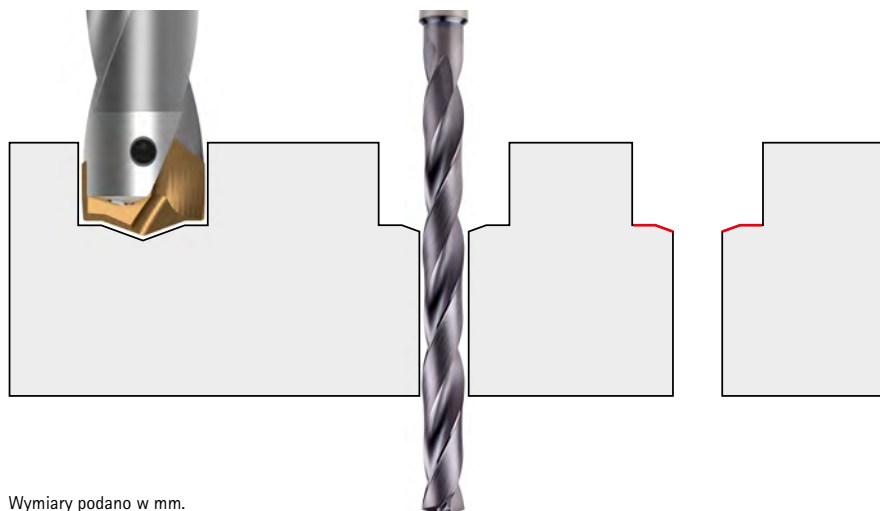

Wymiary podano w mm.

Zalecane parametry skrawania – patrz koniec rozdziału.

Wersje specjalne i inne powłoki wg zapytania ofertowego.

Płytki skrawające QTD

Z węgla spiekane, wewnętrzne doprowadzenie chłodziwa
Typ 02 – Inox

Wersja:

Średnica wiertła: 9,00 – 50,00 mm

Tolerancja otworu: \geq IT 10

Materiał skrawający: HP600

Liczba ostrzy: 2

Liczba tyśinek: 2

Kąt wierzchołkowy: 135°

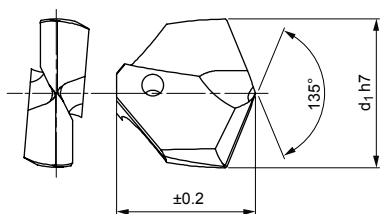

Magazynowa seria preferowana

d ₁ od 10,00 do 16,70			
d ₁ h7	Wielkość uchwytu D	Specyfikacja	Nr materiałowy
10,00	10	QTD-2F02-1000-HP600	30615624
10,50	10,5	QTD-2F02-1050-HP600	30615625
11,00	11	QTD-2F02-1100-HP600	30615627
12,00	12	QTD-2F02-1200-HP600	30615630
12,50	12,5	QTD-2F02-1250-HP600	30615631
13,00	13	QTD-2F02-1300-HP600	30573070
13,50	13,5	QTD-2F02-1350-HP600	30573072
14,00	14	QTD-2F02-1400-HP600	30573074
14,10	14	QTD-2F02-1410-HP600	30646120
14,20	14	QTD-2F02-1420-HP600	30630410
14,30	14	QTD-2F02-1430-HP600	30646122
14,40	14	QTD-2F02-1440-HP600	30646123
14,50	14,5	QTD-2F02-1450-HP600	30573075
14,60	14,5	QTD-2F02-1460-HP600	30646124
14,70	14,5	QTD-2F02-1470-HP600	30573076
14,75	14,5	QTD-2F02-1475-HP600	30573077
14,80	14,5	QTD-2F02-1480-HP600	30646125
15,00	15	QTD-2F02-1500-HP600	30573078
15,20	15	QTD-2F02-1520-HP600	30646128
15,25	15	QTD-2F02-1525-HP600	30573079
15,40	15	QTD-2F02-1540-HP600	30646130
15,50	15	QTD-2F02-1550-HP600	30573080
15,60	15	QTD-2F02-1560-HP600	30646131
15,70	15	QTD-2F02-1570-HP600	30573081
15,80	15	QTD-2F02-1580-HP600	30646132
16,00	16	QTD-2F02-1600-HP600	30573083
16,10	16	QTD-2F02-1610-HP600	30573086
16,20	16	QTD-2F02-1620-HP600	30646134
16,30	16	QTD-2F02-1630-HP600	30646135
16,40	16	QTD-2F02-1640-HP600	30646136
16,50	16	QTD-2F02-1650-HP600	30573088
16,60	16	QTD-2F02-1660-HP600	30646137
16,70	16	QTD-2F02-1670-HP600	30573089

d ₁ od 16,75 do 23,75			
d ₁ h7	Wielkość uchwytu D	Specyfikacja	Nr materiałowy
16,75	16	QTD-2F02-1675-HP600	30573090
16,80	16	QTD-2F02-1680-HP600	30646138
16,90	16	QTD-2F02-1690-HP600	30646139
17,00	17	QTD-2F02-1700-HP600	30573091
17,30	17	QTD-2F02-1730-HP600	30646142
17,40	17	QTD-2F02-1740-HP600	30646143
17,50	17	QTD-2F02-1750-HP600	30573092
17,70	17	QTD-2F02-1770-HP600	30573093
17,90	17	QTD-2F02-1790-HP600	30646146
18,00	18	QTD-2F02-1800-HP600	30573094
18,50	18	QTD-2F02-1850-HP600	30573096
18,60	18	QTD-2F02-1860-HP600	30646151
18,70	18	QTD-2F02-1870-HP600	30573097
19,00	19	QTD-2F02-1900-HP600	30573098
19,40	19	QTD-2F02-1940-HP600	30573101
19,50	19	QTD-2F02-1950-HP600	30573102
19,60	19	QTD-2F02-1960-HP600	30646157
19,70	19	QTD-2F02-1970-HP600	30573103
19,75	19	QTD-2F02-1975-HP600	30573104
19,80	19	QTD-2F02-1980-HP600	30646158
19,90	19	QTD-2F02-1990-HP600	30646159
20,00	20	QTD-2F02-2000-HP600	30573105
20,40	20	QTD-2F02-2040-HP600	30573106
20,50	20	QTD-2F02-2050-HP600	30573107
21,00	21	QTD-2F02-2100-HP600	30573110
21,50	21	QTD-2F02-2150-HP600	30573111
21,70	21	QTD-2F02-2170-HP600	30573112
22,00	22	QTD-2F02-2200-HP600	30573113
22,25	22	QTD-2F02-2225-HP600	30573114
22,70	22	QTD-2F02-2270-HP600	30573117
23,00	23	QTD-2F02-2300-HP600	30573119
23,50	23	QTD-2F02-2350-HP600	30573121
23,75	23	QTD-2F02-2375-HP600	30573124

ciąg dalszy na następnej stronie.

Płytki skrawające QTD z węgla spiekane, wewnętrzne doprowadzenie chłodziwa – typ O2

d ₁ od 24,00 do 27,00				d ₁ od 27,50 do 40,00			
d ₁ h7	Wielkość uchwytu D	Specyfikacja	Nr materiałowy	d ₁ h7	Wielkość uchwytu D	Specyfikacja	Nr materiałowy
24,00	24	QTD-2F02-2400-HP600	30573125	27,50	27	QTD-2F02-2750-HP600	30573136
24,40	24	QTD-2F02-2440-HP600	30665151	28,00	28	QTD-2F02-2800-HP600	30573138
24,50	24	QTD-2F02-2450-HP600	30573126	29,00	29	QTD-2F02-2900-HP600	30573141
24,70	24	QTD-2F02-2470-HP600	30573127	29,50	29	QTD-2F02-2950-HP600	30573142
24,75	24	QTD-2F02-2475-HP600	30573128	30,00	30	QTD-2F02-3000-HP600	30573143
25,00	25	QTD-2F02-2500-HP600	30573129	30,75	30	QTD-2F02-3075-HP600	30573146
25,50	25	QTD-2F02-2550-HP600	30573131	33,00	33	QTD-2F02-3300-HP600	30649662
25,70	25	QTD-2F02-2570-HP600	30573132	36,00	36	QTD-2F02-3600-HP600	30649665
26,00	26	QTD-2F02-2600-HP600	30573133	37,00	37	QTD-2F02-3700-HP600	30649666
26,50	26	QTD-2F02-2650-HP600	30573134	40,00	39	QTD-2F02-4000-HP600	30657246
27,00	27	QTD-2F02-2700-HP600	30573135				

Możliwość konfiguracji parametrów

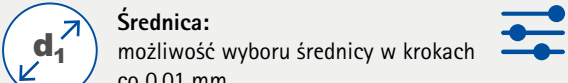

Średnica:
możliwość wyboru średnicy w krokach
co 0,01 mm

Specyfikacja:
QTD-2F02-[średnica]-HP600

Przykład:
QTD-2F02-1401-HP600

Średnica narzędzia d₁ = 14,01 mm

Wymiary typoszeregu z możliwością konfiguracji parametrów

d ₁ min.	d ₁ maks.
9,00	50,00

Wymiary podano w mm.

Zalecane parametry skrawania – patrz koniec rozdziału.

Wersje specjalne i inne powłoki wg zapytania ofertowego.

Płytki skrawające QTD

Z węgla spiekane, wewnętrzne doprowadzenie chłodziwa
Typ 04 – Iron

Wersja:

Średnica wiertła: 9,00 – 50,00 mm
Tolerancja otworu: \geq IT 10
Materiał skrawający: HP240
Liczba ostrzy: 2
Liczba tyśinek: 2
Kąt wierzchołkowy: 135°

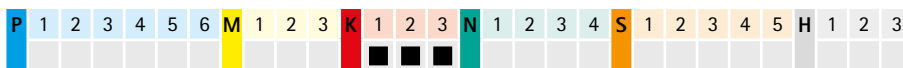
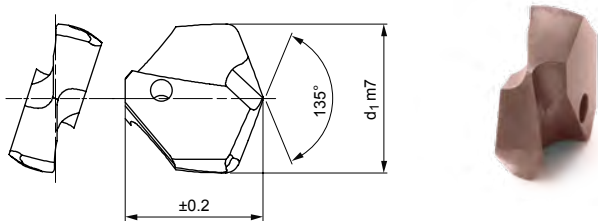

Magazynowa seria preferowana

d ₁ od 12,00 do 23,00			
d ₁ m7	Wielkość uchwytu D	Specyfikacja	Nr materiałowy
12,00	12	QTD-2F04-1200-HP240	30615805
14,00	14	QTD-2F04-1400-HP240	30612900
14,50	14,5	QTD-2F04-1450-HP240	30612901
17,00	17	QTD-2F04-1700-HP240	30612915
17,50	17	QTD-2F04-1750-HP240	30612916
18,00	18	QTD-2F04-1800-HP240	30612918
19,00	19	QTD-2F04-1900-HP240	30612922
19,10	19	QTD-2F04-1910-HP240	30646366
19,50	19	QTD-2F04-1950-HP240	30612926
20,50	20	QTD-2F04-2050-HP240	30612931
21,00	21	QTD-2F04-2100-HP240	30612934
21,50	21	QTD-2F04-2150-HP240	30612935
22,00	22	QTD-2F04-2200-HP240	30612937
23,00	23	QTD-2F04-2300-HP240	30612943

d ₁ od 23,50 do 33,00			
d ₁ m7	Wielkość uchwytu D	Specyfikacja	Nr materiałowy
23,50	23	QTD-2F04-2350-HP240	30612945
24,00	24	QTD-2F04-2400-HP240	30612949
24,50	24	QTD-2F04-2450-HP240	30612950
25,00	25	QTD-2F04-2500-HP240	30612953
25,70	25	QTD-2F04-2570-HP240	30612956
26,00	26	QTD-2F04-2600-HP240	30612957
26,50	26	QTD-2F04-2650-HP240	30612958
28,00	28	QTD-2F04-2800-HP240	30612962
28,50	28	QTD-2F04-2850-HP240	30612964
29,00	29	QTD-2F04-2900-HP240	30612965
29,50	29	QTD-2F04-2950-HP240	30612966
30,00	30	QTD-2F04-3000-HP240	30612967
31,00	31	QTD-2F04-3100-HP240	30612971
33,00	33	QTD-2F04-3300-HP240	30649674

Możliwość konfiguracji parametrów



Średnica:
możliwość wyboru średnicy w krokach
co 0,01 mm



Specyfikacja:
QTD-2F02-[średnica]-HP600

Przykład:

QTD-2F02-1401-HP600

Średnica narzędzia d₁ = 14,01 mm

Wymiary typoszeręgu z możliwością konfiguracji parametrów

d ₁ min.	d ₁ maks.
9,00	50,00

Wymiary podano w mm.

Zalecane parametry skrawania – patrz koniec rozdziału.

Wersje specjalne i inne powłoki wg zapytania ofertowego.

Płytki skrawające QTD

Z węgla spiekane, wewnętrzne doprowadzenie chłodziwa
Typ 03 – Alu

Wersja:

Średnica wiertła: 9,00 – 50,00 mm
Tolerancja otworu: \geq IT 10
Materiał skrawający: HU310
Liczba ostrzy: 2
Liczba tyśinek: 2
Kąt wierzchołkowy: 135°

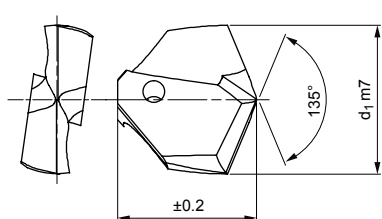

Magazynowa seria preferowana

d ₁ od 13,00 do 20,50			
d ₁ m7	Wielkość uchwytu D	Specyfikacja	Nr materiałowy
13,00	13	QTD-2F03-1300-HU310	30612819
13,50	13,5	QTD-2F03-1350-HU310	30612820
14,00	14	QTD-2F03-1400-HU310	30612822
14,50	14,5	QTD-2F03-1450-HU310	30612823
15,00	15	QTD-2F03-1500-HU310	30612826
15,50	15	QTD-2F03-1550-HU310	30612828
16,00	16	QTD-2F03-1600-HU310	30612830
17,00	17	QTD-2F03-1700-HU310	30612837
17,50	17	QTD-2F03-1750-HU310	30612838
18,25	18	QTD-2F03-1825-HU310	30612841
18,50	18	QTD-2F03-1850-HU310	30612842
19,00	19	QTD-2F03-1900-HU310	30612844
20,00	20	QTD-2F03-2000-HU310	30612851
20,50	20	QTD-2F03-2050-HU310	30612853

d ₁ od 21,00 do 36,00			
d ₁ m7	Wielkość uchwytu D	Specyfikacja	Nr materiałowy
21,00	21	QTD-2F03-2100-HU310	30612856
22,00	22	QTD-2F03-2200-HU310	30612859
22,50	22	QTD-2F03-2250-HU310	30612862
23,00	23	QTD-2F03-2300-HU310	30612865
23,50	23	QTD-2F03-2350-HU310	30612867
24,00	24	QTD-2F03-2400-HU310	30612871
24,50	24	QTD-2F03-2450-HU310	30612872
25,00	25	QTD-2F03-2500-HU310	30612875
26,00	26	QTD-2F03-2600-HU310	30612879
27,00	27	QTD-2F03-2700-HU310	30612881
29,50	29	QTD-2F03-2950-HU310	30612888
30,00	30	QTD-2F03-3000-HU310	30612889
34,00	34	QTD-2F03-3400-HU310	30649669
36,00	36	QTD-2F03-3600-HU310	30649671

Możliwość konfiguracji parametrów



Średnica:
możliwość wyboru średnicy w krokach
co 0,01 mm

Specyfikacja:
QTD-2F03-[średnica]-HU310

Wymiary typoszeregu z możliwością konfiguracji parametrów

d ₁ min.	d ₁ maks.
9,00	50,00

Przykład:

QTD-2F02-1401-HU310

Średnica narzędzia d₁ = 14,01 mm

Wymiary podano w mm.

Zalecane parametry skrawania – patrz koniec rozdziału.

Wersje specjalne i inne powłoki wg zapytania ofertowego.

Uchwyty na płytki skrawające QTS

Z chwytem do mocowania płytek skrawających QTD
QTS100S, wewnętrzne doprowadzenie chłodziwa

Wersja:

Dotyczy średnicy:

9,00 - 50,99 mm

Typ chwytu:

według ISO 9766

System wymiany płytki:

Gniazdo, umożliwiające wymianę płytki w obrabiarce

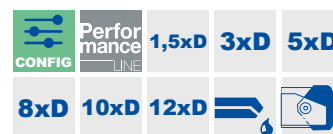
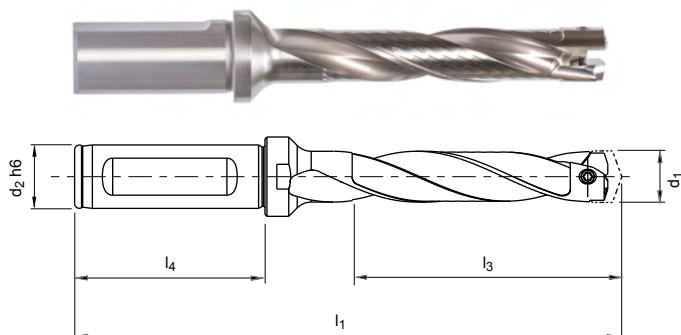

Magazynowa seria preferowana

Wielkość uchwytu D	Wymiary					Specyfikacja	Nr materiałowy
	Zakres średnicy Płytki skrawająca d ₁	d ₂ h6	l ₁	l ₃	l ₄		
9,00	9,00 - 9,49	12	110	48	45	QTS100S-0900-DR05-ZYL12-MN	30605484
9,50	9,50 - 9,99	12	113	50	45	QTS100S-0950-DR05-ZYL12-MN	30605485
10,00	10,00 - 10,49	16	99	32	48	QTS100S-1000-DR03-ZYL16-MN	30605476
10,00	10,00 - 10,49	16	120	53	48	QTS100S-1000-DR05-ZYL16-MN	30605486
10,50	10,50 - 10,99	16	122	55	48	QTS100S-1050-DR05-ZYL16-MN	30605487
11,00	11,00 - 11,49	16	126	58	48	QTS100S-1100-DR05-ZYL16-MN	30605488
11,00	11,00 - 11,49	16	160	92	48	QTS100S-1100-DR08-ZYL16-MN	30605498
11,50	11,50 - 11,99	16	105	36	48	QTS100S-1150-DR03-ZYL16-MN	30605479
12,00	12,00 - 12,49	16	107	38	48	QTS100S-1200-DR03-ZYL16-MN	30605480
12,00	12,00 - 12,49	16	132	63	48	QTS100S-1200-DR05-ZYL16-MN	30605490
12,00	12,00 - 12,49	16	169	100	48	QTS100S-1200-DR08-ZYL16-MN	30605500
12,50	12,50 - 12,99	16	109	39	48	QTS100S-1250-DR03-ZYL16-MN	30605481
12,50	12,50 - 12,99	16	135	65	48	QTS100S-1250-DR05-ZYL16-MN	30605491
12,50	12,50 - 12,99	16	174	104	48	QTS100S-1250-DR08-ZYL16-MN	30605501
13,00	13,00 - 13,49	16	112	41	48	QTS100S-1300-DR03-ZYL16-MN	30572922
13,00	13,00 - 13,49	16	138	68	48	QTS100S-1300-DR05-ZYL16-MN	30572945
13,00	13,00 - 13,49	16	178	108	48	QTS100S-1300-DR08-ZYL16-MN	30572967
13,00	13,00 - 13,49	16	232	162	48	QTS100S-1300-DR12-ZYL16-MN	30598728
13,50	13,50 - 13,99	16	211	140	48	QTS100S-1350-DR10-ZYL16-MN	30826051
13,50	13,50 - 13,99	16	239	168	48	QTS100S-1350-DR12-ZYL16-MN	30598729
14,00	14,00 - 14,49	16	116	44	48	QTS100S-1400-DR03-ZYL16-MN	30572924
14,00	14,00 - 14,49	16	144	73	48	QTS100S-1400-DR05-ZYL16-MN	30572947
14,00	14,00 - 14,49	16	187	116	48	QTS100S-1400-DR08-ZYL16-MN	30572970
14,00	14,00 - 14,49	16	245	174	48	QTS100S-1400-DR12-ZYL16-MN	30598730
14,50	14,50 - 14,99	16	95	23	48	QTS100S-1450-DR01-ZYL16-MN	30572903
14,50	14,50 - 14,99	16	147	75	48	QTS100S-1450-DR05-ZYL16-MN	30572948
15,00	15,00 - 15,99	20	124	48	50	QTS100S-1500-DR03-ZYL20-MN	30572926
15,00	15,00 - 15,99	20	155	80	50	QTS100S-1500-DR05-ZYL20-MN	30572949
15,00	15,00 - 15,99	20	203	128	50	QTS100S-1500-DR08-ZYL20-MN	30572972
15,00	15,00 - 15,99	20	237	162	50	QTS100S-1500-DR10-ZYL20-MN	30826054
15,00	15,00 - 15,99	20	267	192	50	QTS100S-1500-DR12-ZYL20-MN	30598732
16,00	16,00 - 16,99	20	102	26	50	QTS100S-1600-DR01-ZYL20-MN	30572905
16,00	16,00 - 16,99	20	128	51	50	QTS100S-1600-DR03-ZYL20-MN	30572927
16,00	16,00 - 16,99	20	161	85	50	QTS100S-1600-DR05-ZYL20-MN	30572950

ciąg dalszy na następnej stronie.

Uchwyty na płytki skrawające QTS | QTS100, wewnętrzne doprowadzenie chłodziwa

Wielkość uchwy- tu D	Wymiary					Specyfikacja	Nr materiałowy
	Zakres średnicy Płytki skrawająca d ₁	d ₂ h6	l ₁	l ₃	l ₄		
16,00	16,00 - 16,99	20	212	136	50	QTS100S-1600-DR08-ZYL20-MN	30572973
16,00	16,00 - 16,99	20	246	170	50	QTS100S-1600-DR10-ZYL20-MN	30826055
17,00	17,00 - 17,99	20	105	27	50	QTS100S-1700-DR01-ZYL20-MN	30572906
17,00	17,00 - 17,99	20	132	54	50	QTS100S-1700-DR03-ZYL20-MN	30572928
17,00	17,00 - 17,99	20	168	90	50	QTS100S-1700-DR05-ZYL20-MN	30572951
17,00	17,00 - 17,99	20	222	144	50	QTS100S-1700-DR08-ZYL20-MN	30572974
17,00	17,00 - 17,99	20	258	180	50	QTS100S-1700-DR10-ZYL20-MN	30826056
17,00	17,00 - 17,99	20	294	216	50	QTS100S-1700-DR12-ZYL20-MN	30598734
18,00	18,00 - 18,99	25	142	57	56	QTS100S-1800-DR03-ZYL25-MN	30572929
18,00	18,00 - 18,99	25	180	95	56	QTS100S-1800-DR05-ZYL25-MN	30572952
18,00	18,00 - 18,99	25	237	152	56	QTS100S-1800-DR08-ZYL25-MN	30572975
18,00	18,00 - 18,99	25	313	228	56	QTS100S-1800-DR12-ZYL25-MN	30598735
19,00	19,00 - 19,99	25	116	30	56	QTS100S-1900-DR01-ZYL25-MN	30572908
19,00	19,00 - 19,99	25	146	60	56	QTS100S-1900-DR03-ZYL25-MN	30572930
19,00	19,00 - 19,99	25	186	100	56	QTS100S-1900-DR05-ZYL25-MN	30572953
19,00	19,00 - 19,99	25	246	160	56	QTS100S-1900-DR08-ZYL25-MN	30572976
20,00	20,00 - 20,99	25	151	63	56	QTS100S-2000-DR03-ZYL25-MN	30572931
20,00	20,00 - 20,99	25	192	105	56	QTS100S-2000-DR05-ZYL25-MN	30572954
20,00	20,00 - 20,99	25	255	168	56	QTS100S-2000-DR08-ZYL25-MN	30572977
20,00	20,00 - 20,99	25	297	210	56	QTS100S-2000-DR10-ZYL25-MN	30826059
20,00	20,00 - 20,99	25	339	252	56	QTS100S-2000-DR12-ZYL25-MN	30598737
21,00	21,00 - 21,99	25	121	33	56	QTS100S-2100-DR01-ZYL25-MN	30572910
21,00	21,00 - 21,99	25	155	66	56	QTS100S-2100-DR03-ZYL25-MN	30572932
21,00	21,00 - 21,99	25	198	110	56	QTS100S-2100-DR05-ZYL25-MN	30572955
21,00	21,00 - 21,99	25	264	176	56	QTS100S-2100-DR08-ZYL25-MN	30572978
21,00	21,00 - 21,99	25	308	220	56	QTS100S-2100-DR10-ZYL25-MN	30826060
22,00	22,00 - 22,99	25	125	35	56	QTS100S-2200-DR01-ZYL25-MN	30572911
22,00	22,00 - 22,99	25	159	69	56	QTS100S-2200-DR03-ZYL25-MN	30572933
22,00	22,00 - 22,99	25	205	115	56	QTS100S-2200-DR05-ZYL25-MN	30572956
22,00	22,00 - 22,99	25	274	184	56	QTS100S-2200-DR08-ZYL25-MN	30572979
23,00	23,00 - 23,99	25	127	36	56	QTS100S-2300-DR01-ZYL25-MN	30572912
23,00	23,00 - 23,99	25	211	120	56	QTS100S-2300-DR05-ZYL25-MN	30572957
23,00	23,00 - 23,99	25	379	288	56	QTS100S-2300-DR12-ZYL25-MN	30598740
24,00	24,00 - 24,99	32	171	75	60	QTS100S-2400-DR03-ZYL32-MN	30572935
24,00	24,00 - 24,99	32	221	125	60	QTS100S-2400-DR05-ZYL32-MN	30572958
24,00	24,00 - 24,99	32	296	200	60	QTS100S-2400-DR08-ZYL32-MN	30572981
24,00	24,00 - 24,99	32	396	300	60	QTS100S-2400-DR12-ZYL32-MN	30598741
25,00	25,00 - 25,99	32	136	39	60	QTS100S-2500-DR01-ZYL32-MN	30572914
25,00	25,00 - 25,99	32	176	78	60	QTS100S-2500-DR03-ZYL32-MN	30572937
25,00	25,00 - 25,99	32	227	130	60	QTS100S-2500-DR05-ZYL32-MN	30572959
25,00	25,00 - 25,99	32	305	208	60	QTS100S-2500-DR08-ZYL32-MN	30572982
25,00	25,00 - 25,99	32	409	312	60	QTS100S-2500-DR12-ZYL32-MN	30598742
26,00	26,00 - 26,99	32	139	41	60	QTS100S-2600-DR01-ZYL32-MN	30572915
26,00	26,00 - 26,99	32	180	81	60	QTS100S-2600-DR03-ZYL32-MN	30572938
26,00	26,00 - 26,99	32	233	135	60	QTS100S-2600-DR05-ZYL32-MN	30572960
26,00	26,00 - 26,99	32	314	216	60	QTS100S-2600-DR08-ZYL32-MN	30572983
26,00	26,00 - 26,99	32	368	270	60	QTS100S-2600-DR10-ZYL32-MN	30826065
27,00	27,00 - 27,99	32	184	84	60	QTS100S-2700-DR03-ZYL32-MN	30572939
27,00	27,00 - 27,99	32	324	224	60	QTS100S-2700-DR08-ZYL32-MN	30572984
28,00	28,00 - 28,99	32	188	87	60	QTS100S-2800-DR03-ZYL32-MN	30572940
28,00	28,00 - 28,99	32	246	145	60	QTS100S-2800-DR05-ZYL32-MN	30572962
28,00	28,00 - 28,99	32	449	348	60	QTS100S-2800-DR12-ZYL32-MN	30598745
29,00	29,00 - 29,99	32	402	300	60	QTS100S-2900-DR10-ZYL32-MN	30826068
30,00	30,00 - 30,99	32	197	93	60	QTS100S-3000-DR03-ZYL32-MN	30572942
30,00	30,00 - 30,99	32	351	248	60	QTS100S-3000-DR08-ZYL32-MN	30572987
30,00	30,00 - 30,99	32	413	310	60	QTS100S-3000-DR10-ZYL32-MN	30826069

Uchwyty na płytki skrawające QTS | QTS100, wewnętrzne doprowadzenie chłodziwa

Wielkość uchwy- tu D	Wymiary					Specyfikacja	Nr materiałowy
	Zakres średnicy Płytki skrawająca d ₁	d ₂ h ₆	l ₁	l ₃	l ₄		
30,00	30,00 - 30,99	32	475	372	60	QTS100S-3000-DR12-ZYL32-MN	30598747
31,00	31,00 - 31,99	32	264	160	60	QTS100S-3100-DR05-ZYL32-MN	30572965
32,00	32,00 - 32,99	32	271	165	60	QTS100S-3200-DR05-ZYL32-MN	30572966
32,00	32,00 - 32,99	32	436	330	60	QTS100S-3200-DR10-ZYL32-MN	30826071
32,00	32,00 - 32,99	32	502	396	60	QTS100S-3200-DR12-ZYL32-MN	30598749
33,00	33,00 - 33,99	32	209	102	60	QTS100S-3300-DR03-ZYL32-MN	30639167
34,00	34,00 - 34,99	32	283	175	60	QTS100S-3400-DR05-ZYL32-MN	30639172
35,00	35,00 - 35,99	32	218	108	60	QTS100S-3500-DR03-ZYL32-MN	30639169
36,00	36,00 - 36,99	32	222	111	60	QTS100S-3600-DR03-ZYL32-MN	30639170
37,00	37,00 - 38,99	40	318	195	70	QTS100S-3700-DR05-ZYL40-MN	30650288
39,00	39,00 - 40,99	40	249	123	70	QTS100S-3900-DR03-ZYL40-MN	30650284
41,00	41,00 - 42,99	40	257	129	70	QTS100S-4100-DR03-ZYL40-MN	30650285

Możliwość konfiguracji parametrów



Wersja długości:
DR01 | DR03 | DR05 | DR08 | DR10 | DR12



Specyfikacja:
QTS100S-3500-[wersja długości]-ZYL32-MN

Przykład:

QTS100S-3500-DR10-ZYL32-MN

Wersja długości 10xD

Wymiary typoszeregu z możliwością konfiguracji parametrów

Wielkość uchwy- tu D	Zakres średnicy płytki skrawają- cej d ₁	d ₂ h ₆	l ₄	DR01		DR03		DR05		DR08		DR10		DR12		Specyfikacja
				l ₁	l ₃	l ₁	l ₃	l ₁	l ₃	l ₁	l ₃	l ₁	l ₃	l ₁	l ₃	
9	9,00 - 9,49	12	45	77	15	92	29	110	48	138	76	-	-	-	-	QTS100S-0900-[wersja długości]-ZYL12-MN
9,5	9,50 - 9,99	12	45	78	15	93	30	113	50	143	80	-	-	-	-	QTS100S-0950-[wersja długości]-ZYL12-MN
10	10,00 - 10,49	16	48	83	16	99	32	120	53	151	84	-	-	-	-	QTS100S-1000-[wersja długości]-ZYL16-MN
10,5	10,50 - 10,99	16	48	84	17	101	33	122	55	155	88	-	-	-	-	QTS100S-1050-[wersja długości]-ZYL16-MN
11	11,00 - 11,49	16	48	86	18	103	35	126	58	160	92	-	-	-	-	QTS100S-1100-[wersja długości]-ZYL16-MN
11,5	11,50 - 11,99	16	48	86	18	105	36	128	60	164	96	-	-	-	-	QTS100S-1150-[wersja długości]-ZYL16-MN
12	12,00 - 12,49	16	48	88	19	107	38	132	63	169	100	-	-	-	-	QTS100S-1200-[wersja długości]-ZYL16-MN
12,5	12,50 - 12,99	16	48	90	20	109	39	135	65	174	104	-	-	-	-	QTS100S-1250-[wersja długości]-ZYL16-MN
13	13,00 - 13,49	16	48	91	21	112	41	138	68	178	108	135	205	232	162	QTS100S-1300-[wersja długości]-ZYL16-MN
13,5	13,50 - 13,99	16	48	92	21	113	42	141	70	183	112	140	211	239	168	QTS100S-1350-[wersja długości]-ZYL16-MN
14	14,00 - 14,49	16	48	93	22	116	44	144	73	187	116	145	216	245	174	QTS100S-1400-[wersja długości]-ZYL16-MN
14,5	14,50 - 14,99	16	48	95	23	117	45	147	75	192	120	150	222	252	180	QTS100S-1450-[wersja długości]-ZYL16-MN
15	15,00 - 15,99	20	50	99	24	124	48	155	80	203	128	162	237	267	192	QTS100S-1500-[wersja długości]-ZYL20-MN
16	16,00 - 16,99	20	50	102	26	128	51	161	85	212	136	170	246	280	204	QTS100S-1600-[wersja długości]-ZYL20-MN
17	17,00 - 17,99	20	50	105	27	132	54	168	90	222	144	180	258	294	216	QTS100S-1700-[wersja długości]-ZYL20-MN
18	18,00 - 18,99	25	56	114	29	142	57	180	95	237	152	190	275	313	228	QTS100S-1800-[wersja długości]-ZYL25-MN
19	19,00 - 19,99	25	56	116	30	146	60	186	100	246	160	200	286	326	240	QTS100S-1900-[wersja długości]-ZYL25-MN
20	20,00 - 20,99	25	56	119	32	151	63	192	105	255	168	210	297	339	252	QTS100S-2000-[wersja długości]-ZYL25-MN
21	21,00 - 21,99	25	56	121	33	155	66	198	110	264	176	220	308	352	264	QTS100S-2100-[wersja długości]-ZYL25-MN
22	22,00 - 22,99	25	56	125	35	159	69	205	115	274	184	230	320	366	276	QTS100S-2200-[wersja długości]-ZYL25-MN
23	23,00 - 23,99	25	56	127	36	163	72	211	120	283	192	240	331	379	288	QTS100S-2300-[wersja długości]-ZYL25-MN
24	24,00 - 24,99	32	60	134	38	171	75	221	125	296	200	250	346	396	300	QTS100S-2400-[wersja długości]-ZYL32-MN
25	25,00 - 25,99	32	60	136	39	176	78	227	130	305	208	260	357	409	312	QTS100S-2500-[wersja długości]-ZYL32-MN
26	26,00 - 26,99	32	60	139	41	180	81	233	135	314	216	270	368	422	324	QTS100S-2600-[wersja długości]-ZYL32-MN
27	27,00 - 27,99	32	60	142	42	184	84	240	140	324	224	280	380	436	336	QTS100S-2700-[wersja długości]-ZYL32-MN

Ciąg dalszy na następnej stronie.

Wymiary typoszeregu z możliwością konfiguracji parametrów

Wielkość uchwy- tu D	Zakres średnicy płytki skrawają- cej d ₁	d ₂ h ₆	l ₄	DR01		DR03		DR05		DR08		DR10		DR12		Specyfikacja
				l ₁	l ₃	l ₁	l ₃	l ₁	l ₃	l ₁	l ₃	l ₁	l ₃	l ₁	l ₃	
28	28,00 - 28,99	32	60	145	44	188	87	246	145	333	232	290	391	449	348	QTS100S-2800-[wersja długości]-ZYL32-MN
29	29,00 - 29,99	32	60	147	45	192	90	252	150	342	240	300	402	462	360	QTS100S-2900-[wersja długości]-ZYL32-MN
30	30,00 - 30,99	32	60	150	47	197	93	258	155	351	248	310	413	475	372	QTS100S-3000-[wersja długości]-ZYL32-MN
31	31,00 - 31,99	32	60	152	48	201	96	264	160	360	256	320	424	488	384	QTS100S-3100-[wersja długości]-ZYL32-MN
32	32,00 - 32,99	32	60	156	50	205	99	271	165	370	264	330	436	502	396	QTS100S-3200-[wersja długości]-ZYL32-MN
33	33,00 - 33,99	32	60	158	51	209	102	277	170	379	272	340	447	515	408	QTS100S-3300-[wersja długości]-ZYL32-MN
34	34,00 - 34,99	32	60	161	53	213	105	283	175	388	280	350	458	528	420	QTS100S-3400-[wersja długości]-ZYL32-MN
35	35,00 - 35,99	32	60	163	54	218	108	289	180	397	288	360	469	541	432	QTS100S-3500-[wersja długości]-ZYL32-MN
36	36,00 - 36,99	32	60	166	56	222	111	295	185	406	296	370	480	554	444	QTS100S-3600-[wersja długości]-ZYL32-MN
37	37,00 - 38,99	40	70	182	59	240	117	318	195	435	312	390	515	591	468	QTS100S-3700-[wersja długości]-ZYL40-MN
39	39,00 - 40,99	40	70	187	62	249	123	330	205	453	328	410	537	617	492	QTS100S-3900-[wersja długości]-ZYL40-MN
41	41,00 - 42,99	40	70	193	65	257	129	343	215	472	344	430	560	644	516	QTS100S-4100-[wersja długości]-ZYL40-MN
43	43,00 - 44,99	40	70	198	68	265	135	355	225	490	360	440	582	670	540	QTS100S-4300-[wersja długości]-ZYL40-MN
45	45,00 - 46,99	40	70	203	71	274	141	367	235	508	376	470	604	696	564	QTS100S-4500-[wersja długości]-ZYL40-MN
47	47,00 - 48,99	40	70	211	74	284	147	382	245	529	392	490	627	725	588	QTS100S-4700-[wersja długości]-ZYL40-MN
49	49,00 - 50,99	40	70	216	77	293	153	394	255	547	408	510	649	751	612	QTS100S-4900-[wersja długości]-ZYL40-MN

Części zamienne

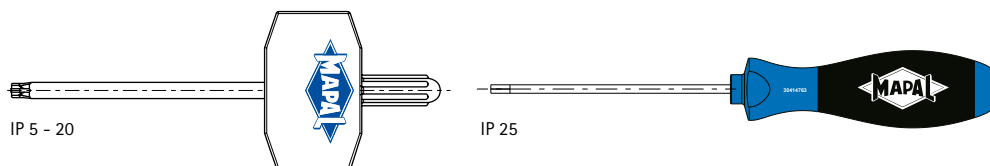

Wkrętak

Wielkość TORX® TORX PLUS®	Nr materiałowy
5 IP	30584281
6 IP	30584282
7 IP	30584283
8 IP	30584284
9 IP	30584285
10 IP	30584286
15 IP	30584287
20 IP	30584288
25 IP	30414767

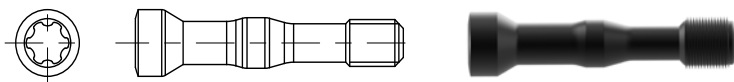

Śruba mocująca

Zakres \emptyset	Rozmiar TORX PLUS®	Nr materiałowy	Specyfikacja	Moment dokręcenia [Nm]
8,00 - 8,99	5 IP	30604440	M1.2X7.5-TX5-IP	0,2
9,00 - 10,99	5 IP	30546309	M1.2X8.5-TX5-IP	0,2
11,00 - 12,99	6 IP	30604180	M1.6X10.5-TX6-IP	0,4
13,00 - 13,99	7 IP	30510826	M2x12-TX7-IP	0,6
14,00 - 15,99	8 IP	30510827	M2.2x13-TX8-IP	0,9
16,00 - 18,99	8 IP	30495432	M2.5x15-TX8-IP	1,2
19,00 - 21,99	9 IP	30510829	M3x18-TX9-IP	2,2
22,00 - 24,99	10 IP	30510830	M3.5x21-TX10-IP	3,3
25,00 - 27,99	15 IP	30510831	M4x24-TX15-IP	5,0
28,00 - 30,99	15 IP	30510832	M4.5x27-TX15-IP	5,7
31,00 - 32,99	20 IP	30510833	M5x30-TX20-IP	7,5
33,00 - 36,99	20 IP	30651830	M5X32-TX20-IP	7,5
37,00 - 44,99	25 IP	30651399	M6X35-TX25-IP	15,0
45,00 - 50,99	25 IP	30651510	M6X43-TX25-IP	15,0

Zalecane parametry skrawania dla płytek skrawających QTD

Posuw i prędkość skrawania

Typ 01 – Steel

MZG*		Materiał obrabiany	Wytrzymałość/twardość [N/mm ²] [HRC]
P	P1	P1.1 Stale konstrukcyjne, użytkowe i uszlachetnione, stale niestopowe	< 700
		P1.2 Stale konstrukcyjne, użytkowe i uszlachetnione, stale niestopowe	< 1 200
	P2	P2.1 Stale azotowane, użytkowe i uszlachetnione, stale stopowe	< 900
		P2.2 Stale azotowane, użytkowe i uszlachetnione, stale stopowe	< 1 400
	P3	P3.1 Stale narzędziowe, łożyskowe, sprężynowe i stale szybkoobrotowe**	< 800
		P3.2 Stale narzędziowe, łożyskowe, sprężynowe i stale szybkoobrotowe**	< 1 000
		P3.3 Stale narzędziowe, łożyskowe, sprężynowe i stale szybkoobrotowe**	< 1 500
P5	P5.1 Staliwo		
K	K1	K1.1 Żeliwo z grafitem płatkowym (żeliwo szare), GJL	< 300
		K2.1 Żeliwo sferoidalne, GJS	< 500
	K2	K2.2 Żeliwo sferoidalne, GJS	≤ 800
		K2.3 Żeliwo sferoidalne, GJS	> 800
	K3	K3.1 Żeliwo wermikularne, GJV, (żeliwo ciągliwe), GJL	< 500
		K3.2 Żeliwo wermikularne, GJV, (żeliwo ciągliwe), GJL	> 500

Typ 05 – Steel-Pyramid

MZG*		Materiał obrabiany	Wytrzymałość/twardość [N/mm ²] [HRC]
P	P1	P1.1 Stale konstrukcyjne, użytkowe i uszlachetnione, stale niestopowe	< 700
		P1.2 Stale konstrukcyjne, użytkowe i uszlachetnione, stale niestopowe	< 1 200
	P2	P2.1 Stale azotowane, użytkowe i uszlachetnione, stale stopowe	< 900
		P2.2 Stale azotowane, użytkowe i uszlachetnione, stale stopowe	< 1 400
	P3	P3.1 Stale narzędziowe, łożyskowe, sprężynowe i stale szybkoobrotowe**	< 800
		P3.2 Stale narzędziowe, łożyskowe, sprężynowe i stale szybkoobrotowe**	< 1 000
		P3.3 Stale narzędziowe, łożyskowe, sprężynowe i stale szybkoobrotowe**	< 1 500
K	K1	K1.1 Żeliwo z grafitem płatkowym (żeliwo szare), GJL	< 300
		K2.1 Żeliwo sferoidalne, GJS	< 500
	K2	K2.2 Żeliwo sferoidalne, GJS	≤ 800
		K2.3 Żeliwo sferoidalne, GJS	> 800

Typ 10 – Uni, kształt EK

MZG*		Materiał obrabiany	Wytrzymałość/twardość [N/mm ²] [HRC]
P	P1	P1.1 Stale konstrukcyjne, użytkowe i uszlachetnione, stale niestopowe	< 700
		P1.2 Stale konstrukcyjne, użytkowe i uszlachetnione, stale niestopowe	< 1200
	P2	P2.1 Stale azotowane, użytkowe i uszlachetnione, stale stopowe	< 900
		P2.2 Stale azotowane, użytkowe i uszlachetnione, stale stopowe	< 1400
	P3	P3.1 Stale narzędziowe, łożyskowe, sprężynowe i stale szybkoobrotowe**	< 800
		P3.2 Stale narzędziowe, łożyskowe, sprężynowe i stale szybkoobrotowe**	< 1000
		P3.3 Stale narzędziowe, łożyskowe, sprężynowe i stale szybkoobrotowe**	< 1500
P5	P5.1 Stal odlewana		
K	K1	K1.1 Żeliwo z grafitem płatkowym (żeliwo szare), GJL	< 300
	K2	K2.1 Żeliwo sferoidalne, GJS	< 500

* Grupa materiałowa wg MAPAL

** Jeśli składniki stopu Cr, Mo, Ni, V, W wynoszą łącznie > 8%, należy wybrać następną w kolejności grupę materiałową MAPAL.

	Prędkość skrawania v_c [m/min]				Posuw f [mm] przy średnicy wiertła					
	Chłodzenie wewnętrzne	Chłodzenie zewnętrzne	Mgietka	Powietrze	8,00	11,50	16,50	24,00	34,50	50,00
	100	90	90		0,20	0,26	0,31	0,36	0,38	0,39
	90	75	75		0,25	0,32	0,39	0,45	0,47	0,49
	100	85	85		0,24	0,30	0,37	0,43	0,45	0,46
	70	60	60		0,19	0,24	0,29	0,34	0,35	0,36
	75	65	65		0,22	0,27	0,33	0,38	0,40	0,42
	60	55	55		0,18	0,22	0,27	0,31	0,33	0,34
	60	45	50		0,14	0,18	0,21	0,24	0,25	0,26
	100	85	85		0,24	0,30	0,37	0,43	0,45	0,46
	95	70	70	70	0,25	0,33	0,41	0,47	0,49	0,51
	130	80	95	95	0,24	0,30	0,37	0,43	0,46	0,47
	80	60	60		0,21	0,26	0,32	0,37	0,39	0,40
	50	30	40		0,14	0,18	0,21	0,24	0,26	0,26
	70	65	65		0,22	0,28	0,35	0,40	0,42	0,43
	65	55	55		0,18	0,23	0,27	0,32	0,33	0,34

	Prędkość skrawania v_c [m/min]				Posuw f [mm] przy średnicy wiertła					
	Chłodzenie wewnętrzne	Chłodzenie zewnętrzne	Mgietka	Powietrze	14,00	16,50	19,50	23,00	27,00	32,00
	120	110	110		0,26	0,29	0,31	0,33	0,34	0,34
	110	90	90		0,33	0,36	0,38	0,41	0,42	0,43
	120	100	100		0,31	0,34	0,36	0,38	0,40	0,41
	90	80	80		0,28	0,30	0,33	0,35	0,36	0,37
	95	70	70	70	0,39	0,43	0,46	0,49	0,51	0,52
	110	70	85	85	0,36	0,40	0,43	0,45	0,47	0,48

	Prędkość skrawania v_c [m/min]				Posuw f [mm] przy średnicy wiertła					
	Chłodzenie wewnętrzne	Chłodzenie zewnętrzne	Mgietka	Powietrze	10,00	13,00	16,00	21,00	26,00	33,00
	120	110	110		0,22	0,25	0,28	0,31	0,34	0,35
	110	90	90		0,27	0,31	0,35	0,39	0,42	0,43
	120	100	100		0,25	0,29	0,33	0,37	0,40	0,41
	90	80	80		0,23	0,26	0,30	0,33	0,36	0,37
	95	70	70	70	0,31	0,36	0,42	0,47	0,51	0,52
	110	70	85	85	0,29	0,34	0,39	0,43	0,47	0,48

Podane parametry skrawania to wartości orientacyjne.

Optymalne wartości dla danego przypadku obróbki należy ustalić w ramach próby lub podczas obróbki.

Zalecane parametry skrawania dla płytek skrawających QTD

Posuw i prędkość skrawania

Typ O2 – Inox

MZG*	Materiał obrabiany	Wytrzymałość/twardość [N/mm ²] [HRC]
P	P1.1 Stale konstrukcyjne, użytkowe i uszlachetnione, stale niestopowe	< 700
	P1.2 Stale konstrukcyjne, użytkowe i uszlachetnione, stale niestopowe	< 1 200
	P2.1 Stale azotowane, użytkowe i uszlachetnione, stale stopowe	< 900
	P2.2 Stale azotowane, użytkowe i uszlachetnione, stale stopowe	< 1 400
	P3.1 Stale narzędziowe, łożyskowe, sprężynowe i stale szybko tnące**	< 800
	P3.2 Stale narzędziowe, łożyskowe, sprężynowe i stale szybko tnące**	< 1 000
	P3.3 Stale narzędziowe, łożyskowe, sprężynowe i stale szybko tnące**	< 1 500
	P4.1 Stale nierdzewne, ferrytyczne i martenzytyczne	
	P5.1 Staliwo	
	P6.1 Staliwo nierdzewne, ferrytyczne i martenzytyczne	
M	M1.1 Stale nierdzewne, austenityczne	< 700
	M1.2 Stale nierdzewne, ferrytyczne/austenityczne (Duplex)	< 1 000
	M2.1 Staliwo nierdzewne, austenityczne	< 700
	M3.1 Staliwo nierdzewne, ferrytyczne/austenityczne (Duplex)	< 1 000
K	K1.1 Żeliwo z grafitem płatkowym (żeliwo szare), GJL	< 300
	K2.1 Żeliwo sferoidalne, GJS	< 500
	K2.2 Żeliwo sferoidalne, GJS	≤ 800
	K2.3 Żeliwo sferoidalne, GJS	> 800
	K3.1 Żeliwo wermikularne, GJV, (żeliwo ciągliwe), GJL	< 500
	K3.2 Żeliwo wermikularne, GJV, (żeliwo ciągliwe), GJL	> 500

Typ O3 – Alu

MZG*	Materiał obrabiany	Wytrzymałość/twardość [N/mm ²] [HRC]
N	N1.1 Aluminium, niestopowe i stopowe < 3 % Si	
	N1.2 Aluminium, stopowe ≤ 7 % Si	
	N1.3 Aluminium, stopowe > 7-12 % Si	
	N1.4 Aluminium, stopowe > 12 % Si	
	N2.1 Miedź, niestopowa i niskostopowa	< 300
	N2.2 Miedź, stopowa	> 300
	N2.3 Mosiądz, brąz, spiż	< 1 200

Typ O4 – Iron

MZG*	Materiał obrabiany	Wytrzymałość/twardość [N/mm ²] [HRC]
K	K1.1 Żeliwo z grafitem płatkowym (żeliwo szare), GJL	< 300
	K2.1 Żeliwo sferoidalne, GJS	< 500
	K2.2 Żeliwo sferoidalne, GJS	≤ 800
	K2.3 Żeliwo sferoidalne, GJS	> 800
	K3.1 Żeliwo wermikularne, GJV, (żeliwo ciągliwe), GJL	< 500
	K3.2 Żeliwo wermikularne, GJV, (żeliwo ciągliwe), GJL	> 500

* Grupa materiałowa wg MAPAL

** Jeśli składniki stopu Cr, Mo, Ni, V, W wynoszą łącznie > 8%, należy wybrać następną w kolejności grupę materiałową MAPAL.

	Prędkość skrawania v_c [m/min]				Posuw f [mm] przy średnicy wiertła					
	Chłodzenie wewnętrzne	Chłodzenie zewnętrzne	Mgiełka	Powietrze	9,00	12,00	16,00	21,00	27,50	36,00
	100	90	90		0,19	0,23	0,27	0,30	0,32	0,33
	90	75	75		0,24	0,29	0,34	0,38	0,40	0,41
	100	85	85		0,23	0,27	0,32	0,36	0,38	0,39
	70	60	60		0,18	0,22	0,25	0,28	0,30	0,31
	75	65	65		0,20	0,24	0,29	0,32	0,34	0,35
	60	55	55		0,17	0,20	0,23	0,26	0,28	0,29
	60	45	50		0,13	0,16	0,18	0,20	0,21	0,22
	60	45	50		0,13	0,16	0,19	0,21	0,23	0,23
	100	85	85		0,23	0,27	0,32	0,36	0,38	0,39
	60	45	50		0,13	0,16	0,19	0,21	0,23	0,23
	55	35	35		0,15	0,18	0,22	0,24	0,26	0,27
	50	30	30		0,13	0,16	0,19	0,21	0,22	0,23
	55	35	35		0,15	0,18	0,22	0,24	0,26	0,27
	50	30	30		0,13	0,16	0,19	0,21	0,22	0,23
	110	75	75	75	0,27	0,34	0,40	0,45	0,49	0,50
	145	90	110	110	0,26	0,31	0,37	0,42	0,45	0,46
	90	70	70		0,22	0,27	0,32	0,36	0,38	0,39
	55	35	45		0,15	0,18	0,21	0,23	0,25	0,26
	80	70	70		0,24	0,29	0,34	0,38	0,41	0,42
	70	65	65		0,19	0,23	0,27	0,30	0,33	0,33

	Prędkość skrawania v_c [m/min]				Posuw f [mm] przy średnicy wiertła					
	Chłodzenie wewnętrzne	Chłodzenie zewnętrzne	Mgiełka	Powietrze	9,00	12,00	16,00	21,00	27,50	36,00
	300	200	250		0,19	0,23	0,27	0,30	0,32	0,33
	250	180	200		0,25	0,30	0,35	0,40	0,43	0,43
	220	150	180		0,25	0,30	0,35	0,40	0,43	0,43
	180	120	150		0,25	0,30	0,35	0,40	0,43	0,43
	140	100			0,19	0,23	0,27	0,30	0,32	0,33
	120	90			0,25	0,30	0,35	0,40	0,43	0,43
	200	160	160	120	0,30	0,37	0,44	0,50	0,54	0,55

	Prędkość skrawania v_c [m/min]				Posuw f [mm] przy średnicy wiertła					
	Chłodzenie wewnętrzne	Chłodzenie zewnętrzne	Mgiełka	Powietrze	9,00	12,00	16,00	21,00	27,50	36,00
	120	85	85	85	0,37	0,45	0,53	0,60	0,65	0,66
	160	100	120	120	0,34	0,42	0,49	0,55	0,59	0,61
	100	75	75		0,30	0,36	0,42	0,48	0,51	0,52
	60	40	50		0,20	0,24	0,28	0,31	0,34	0,34
	90	80	80		0,32	0,39	0,46	0,51	0,55	0,56
	80	70	70		0,26	0,31	0,36	0,40	0,43	0,44

Podane parametry skrawania to wartości orientacyjne.

Optymalne wartości dla danego przypadku obróbki należy ustalić w ramach próby lub podczas obróbki.

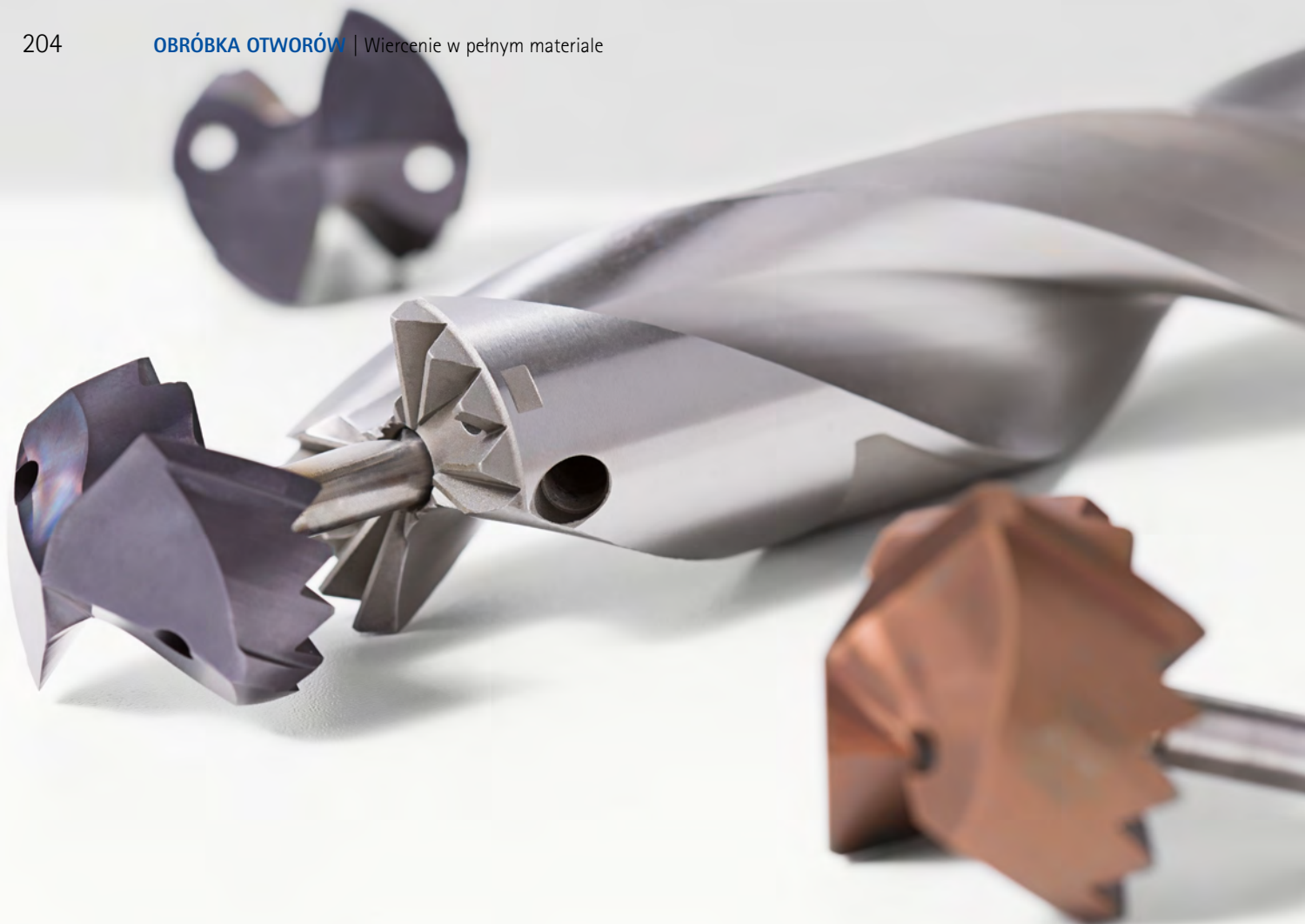

WIERTŁA Z WYMIENNĄ GŁOWICĄ TTD

Zminimalizowane zużycie węgla spiekane przy zachowaniu najwyższej stabilności i precyzji

Wiertło z wymienną głowicą TTD osiąga parametry i poziom jakości wiertel z węgla spiekane. Zastosowanie mniejszej ilości węgla spiekane na wymiennych głowicach wiertarskich zapewnia jednocześnie obniżenie kosztów narzędzi.

Centralnym elementem wiertła z wymienną głowicą TTD jest złącze TTS (Torque Transfer System), które gwarantuje wyjątkowo stabilne

połączenie. Złącze charakteryzuje się optymalnym przeniesieniem momentu obrotowego oraz wysoką dokładnością przezbrajania i niską wartością bicia.

Standardowe typy szeregi wiertel z wymienną głowicą TTD obejmują głębokości wiercenia 1xD, 3xD, 5xD, 8xD i 12xD. Dzięki pięciu różnym wymiennym głowicom wiertarskim możliwe jest wykonanie nawet skomplikowanych zadań obróbkowych w niemal wszystkich materiałach obrabianych w zakresie średnicy od 12 do 45 mm.

Głowice wiertarskie są zoptymalizowane pod kątem prawidłowego centrowania. Dzięki specjalnej geometrii czoła wióry kierowane są odpowiednio do rowków wiórowych znajdujących się w uchwycie TTS. Ponadto geometria z 3 lub 4 łysinkami sprzyja bardzo spokojnej pracy wiertła w otworze. Połączenie tych właściwości zapewnia długą wytrzymałość narzędzia i wyniki wiercenia na najwyższym poziomie.

Cechy charakterystyczne narzędzia

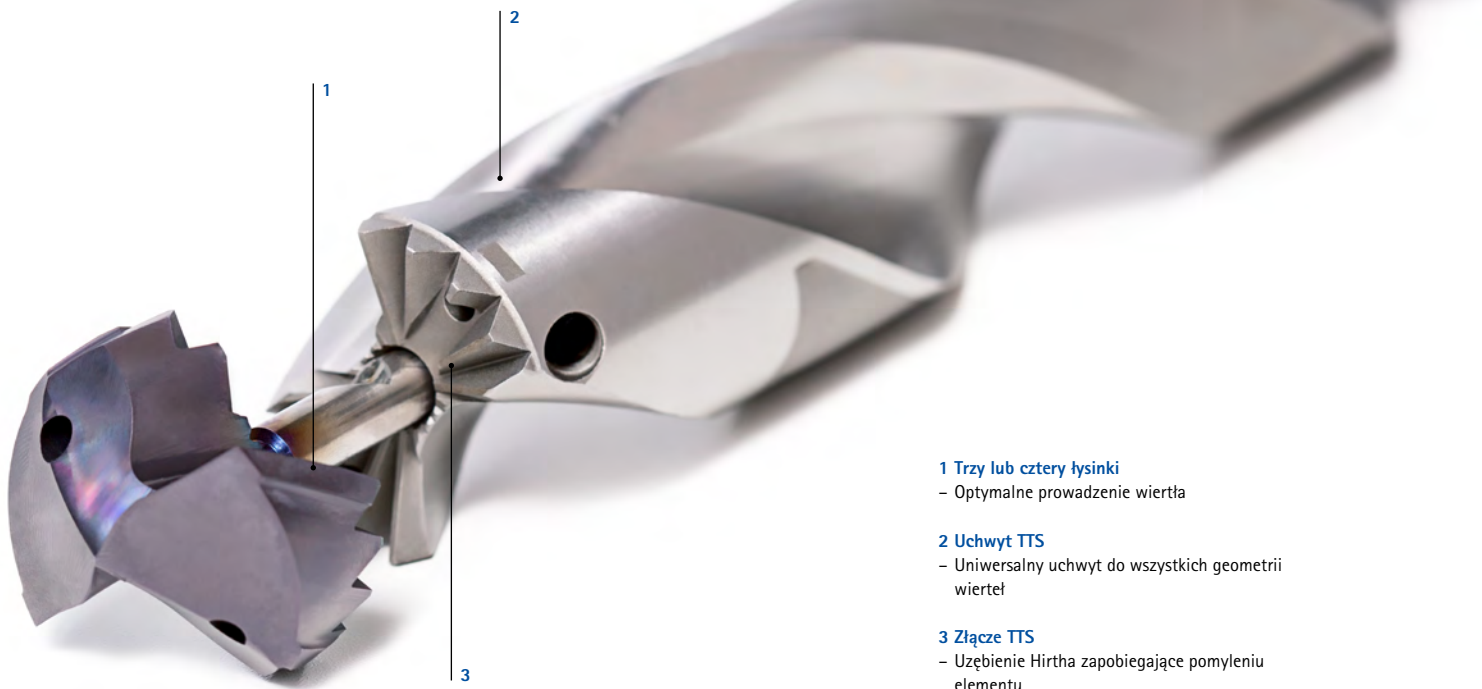

1 Trzy lub cztery łysinki

- Optymalne prowadzenie wiertła

2 Uchwyt TTS

- Uniwersalny uchwyt do wszystkich geometrii wiertel

3 Złącze TTS

- Uzębienie Hirtha zapobiegające pomyleniu elementu



W SKRÓCIE

- Dostępne z magazynu
- Zakres \varnothing 12,00 do 45,00 mm
- Głębokości wiercenia 1 | 3 | 5 | 8 i 12xD
- Z chłodzeniem wewnętrznym
- Prosta obsługa
- Możliwość wymiany głowicy w maszynie

WŁAŚCIWOŚCI UŻYTKOWE

- Parametry identyczne jak w przypadku wiertel z węgliku spiekanego
- Wysoka wartość bicia
- Dobra dokładność pozycji narzędzia
- Przenoszenie wysokiego momentu obrotowego

ZALETY

- W razie potrzeby możliwość ponownego szlifowania
- System wymiany głowicy uniemożliwiający pomylenie elementu
- Jeden rodzaj uchwytu TTS umożliwiający montaż różnych wersji głowic wierzących
- Możliwość realizacji niemal wszystkich geometrii wiercenia

Wymienna głowica TTD

Z węgla spiekane, wewnętrzne doprowadzenie chłodziwa
Typ 01P – Uni-Plus

Wersja:

Średnica wiertła: 12,00 – 45,00 mm
Tolerancja otworu: \geq IT 9
Materiał skrawający: HP358
Liczba ostrzy: 2
Liczba tyśinek: 4
Kąt wierzchołkowy: 140°

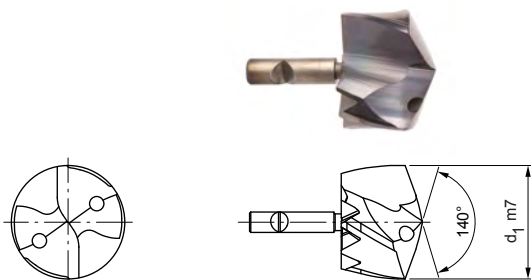

Magazynowa seria preferowana

d ₁ od 12,00 do 21,00		
d ₁ m7	Specyfikacja	Nr materiałowy
12,00	TTD-4F01P-1200-HP358	31164086
13,50	TTD-4F01P-1350-HP358	31164141
14,00	TTD-4F01P-1400-HP358	31164146
14,50	TTD-4F01P-1450-HP358	31164151
15,00	TTD-4F01P-1500-HP358	31164156
15,50	TTD-4F01P-1550-HP358	31164161
15,60	TTD-4F01P-1560-HP358	31164162
15,80	TTD-4F01P-1580-HP358	31164164
16,00	TTD-4F01P-1600-HP358	31164166
16,50	TTD-4F01P-1650-HP358	31164171
17,00	TTD-4F01P-1700-HP358	31164176
17,50	TTD-4F01P-1750-HP358	31164181
17,70	TTD-4F01P-1770-HP358	31164183
17,80	TTD-4F01P-1780-HP358	31164184
18,00	TTD-4F01P-1800-HP358	31164186
18,50	TTD-4F01P-1850-HP358	31164191
18,80	TTD-4F01P-1880-HP358	31164194
19,00	TTD-4F01P-1900-HP358	31164196
19,50	TTD-4F01P-1950-HP358	31164201
19,70	TTD-4F01P-1970-HP358	31164203
20,00	TTD-4F01P-2000-HP358	31164206
20,50	TTD-4F01P-2050-HP358	31164211
21,00	TTD-4F01P-2100-HP358	31164216

d ₁ od 21,50 do 40,00		
d ₁ m7	Specyfikacja	Nr materiałowy
21,50	TTD-4F01P-2150-HP358	31164221
22,00	TTD-4F01P-2200-HP358	31164226
22,50	TTD-4F01P-2250-HP358	31164231
23,00	TTD-4F01P-2300-HP358	31164236
24,00	TTD-4F01P-2400-HP358	31164246
24,50	TTD-4F01P-2450-HP358	31164251
25,00	TTD-4F01P-2500-HP358	31164256
25,40	TTD-4F01P-2540-HP358	31164260
25,50	TTD-4F01P-2550-HP358	31164261
26,00	TTD-4F01P-2600-HP358	31164266
26,50	TTD-4F01P-2650-HP358	31164271
27,00	TTD-4F01P-2700-HP358	31164276
28,00	TTD-4F01P-2800-HP358	31164286
28,50	TTD-4F01P-2850-HP358	31164291
30,00	TTD-4F01P-3000-HP358	31164306
30,70	TTD-4F01P-3070-HP358	31164313
31,00	TTD-4F01P-3100-HP358	31164316
32,00	TTD-4F01P-3200-HP358	31164326
33,00	TTD-4F01P-3300-HP358	31164328
37,00	TTD-4F01P-3700-HP358	31164336
38,50	TTD-4F01P-3850-HP358	31164339
39,00	TTD-4F01P-3900-HP358	31164340
40,00	TTD-4F01P-4000-HP358	31164342

Możliwość konfiguracji parametrów



Średnica:
możliwość wyboru średnicy w krokach
co 0,01 mm

Specyfikacja:
TTD-4F01P-[średnica]-HP358

Wymiary typoszeregu z możliwością konfiguracji parametrów

d ₁ min.	d ₁ maks.
12,00	45,00

Przykład:
TTD-4F01P-1401-HP358

Średnica narzędzia d₁ = 14,01 mm

Wymienna głowica TTD

Z węgla spiekane, wewnętrzne doprowadzenie chłodziwa
Typ 04 – Steel

Wersja:

Średnica wiertła: 12,00 – 45,00 mm

Tolerancja otworu: \geq IT 9

Materiał skrawający: HP358

Liczba ostrzy: 2

Liczba tyśinek: 3

Kąt wierzchołkowy: 138°

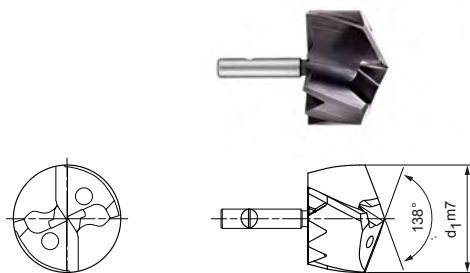

Magazynowa seria preferowana

d_1 od 12,00 do 17,00		
d_1 m7	Specyfikacja	Nr materiałowy
12,00	TTD-3F04-1200-HP358	30530406
12,10	TTD-3F04-1210-HP358	30596953
12,20	TTD-3F04-1220-HP358	30596954
12,50	TTD-3F04-1250-HP358	30530407
12,80	TTD-3F04-1280-HP358	30596958
13,00	TTD-3F04-1300-HP358	30530409
13,10	TTD-3F04-1310-HP358	30596960
13,20	TTD-3F04-1320-HP358	30596961
13,50	TTD-3F04-1350-HP358	30530410
14,00	TTD-3F04-1400-HP358	30530412
14,10	TTD-3F04-1410-HP358	30596967
14,20	TTD-3F04-1420-HP358	30596968
14,30	TTD-3F04-1430-HP358	30596969
14,40	TTD-3F04-1440-HP358	30596970
14,50	TTD-3F04-1450-HP358	30530413
14,70	TTD-3F04-1470-HP358	30530414
14,80	TTD-3F04-1480-HP358	30596972
15,00	TTD-3F04-1500-HP358	30530415
15,10	TTD-3F04-1510-HP358	30596974
15,20	TTD-3F04-1520-HP358	30596975
15,50	TTD-3F04-1550-HP358	30530416
15,70	TTD-3F04-1570-HP358	30530417
15,80	TTD-3F04-1580-HP358	30596979
16,00	TTD-3F04-1600-HP358	30530418
16,10	TTD-3F04-1610-HP358	30596981
16,20	TTD-3F04-1620-HP358	30596982
16,30	TTD-3F04-1630-HP358	30596983
16,40	TTD-3F04-1640-HP358	30596984
16,50	TTD-3F04-1650-HP358	30530419
16,60	TTD-3F04-1660-HP358	30596985
16,70	TTD-3F04-1670-HP358	30530420
16,80	TTD-3F04-1680-HP358	30596986
17,00	TTD-3F04-1700-HP358	30530421

d_1 od 17,10 do 21,40		
d_1 m7	Specyfikacja	Nr materiałowy
17,10	TTD-3F04-1710-HP358	30596988
17,30	TTD-3F04-1730-HP358	30596990
17,50	TTD-3F04-1750-HP358	30530422
17,60	TTD-3F04-1760-HP358	30596992
17,70	TTD-3F04-1770-HP358	30530423
17,80	TTD-3F04-1780-HP358	30596993
18,00	TTD-3F04-1800-HP358	30530424
18,10	TTD-3F04-1810-HP358	30596995
18,20	TTD-3F04-1820-HP358	30596996
18,30	TTD-3F04-1830-HP358	30596997
18,40	TTD-3F04-1840-HP358	30596998
18,50	TTD-3F04-1850-HP358	30530425
18,80	TTD-3F04-1880-HP358	30597000
18,90	TTD-3F04-1890-HP358	30597001
19,00	TTD-3F04-1900-HP358	30530427
19,20	TTD-3F04-1920-HP358	30597003
19,30	TTD-3F04-1930-HP358	30597004
19,50	TTD-3F04-1950-HP358	30530428
19,70	TTD-3F04-1970-HP358	30530429
19,80	TTD-3F04-1980-HP358	30597007
19,90	TTD-3F04-1990-HP358	30597008
20,00	TTD-3F04-2000-HP358	30530431
20,10	TTD-3F04-2010-HP358	30597009
20,20	TTD-3F04-2020-HP358	30597010
20,30	TTD-3F04-2030-HP358	30597011
20,40	TTD-3F04-2040-HP358	30597012
20,50	TTD-3F04-2050-HP358	30530432
20,60	TTD-3F04-2060-HP358	30597013
20,70	TTD-3F04-2070-HP358	30530433
21,00	TTD-3F04-2100-HP358	30530434
21,10	TTD-3F04-2110-HP358	30597016
21,20	TTD-3F04-2120-HP358	30597017
21,40	TTD-3F04-2140-HP358	30597019

Ciąg dalszy na następnej stronie.

Wymienne głowice TTD z węgla spiekane, wewnętrzne doprowadzenie chłodziwa – typ 04

d ₁ od 21,50 do 26,10			d ₁ od 26,20 do 41,00		
d ₁ m7	Specyfikacja	Nr materiałowy	d ₁ m7	Specyfikacja	Nr materiałowy
21,50	TTD-3F04-2150-HP358	30530435	26,20	TTD-3F04-2620-HP358	30597052
21,70	TTD-3F04-2170-HP358	30530436	26,50	TTD-3F04-2650-HP358	30530450
21,80	TTD-3F04-2180-HP358	30597021	26,70	TTD-3F04-2670-HP358	30530451
22,00	TTD-3F04-2200-HP358	30530437	27,00	TTD-3F04-2700-HP358	30530452
22,10	TTD-3F04-2210-HP358	30597023	27,50	TTD-3F04-2750-HP358	30530453
22,20	TTD-3F04-2220-HP358	30597024	27,70	TTD-3F04-2770-HP358	30530454
22,30	TTD-3F04-2230-HP358	30597025	27,80	TTD-3F04-2780-HP358	30597063
22,40	TTD-3F04-2240-HP358	30597026	28,00	TTD-3F04-2800-HP358	30530455
22,50	TTD-3F04-2250-HP358	30530438	28,20	TTD-3F04-2820-HP358	30597066
22,60	TTD-3F04-2260-HP358	30597027	28,30	TTD-3F04-2830-HP358	30597067
22,70	TTD-3F04-2270-HP358	30530439	28,50	TTD-3F04-2850-HP358	30530456
23,00	TTD-3F04-2300-HP358	30530440	29,00	TTD-3F04-2900-HP358	30530458
23,10	TTD-3F04-2310-HP358	30597030	30,00	TTD-3F04-3000-HP358	30530461
23,30	TTD-3F04-2330-HP358	30597032	30,30	TTD-3F04-3030-HP358	30597082
23,50	TTD-3F04-2350-HP358	30530441	30,50	TTD-3F04-3050-HP358	30530462
23,70	TTD-3F04-2370-HP358	30530442	31,00	TTD-3F04-3100-HP358	30530464
24,00	TTD-3F04-2400-HP358	30530443	31,50	TTD-3F04-3150-HP358	30530465
24,40	TTD-3F04-2440-HP358	30597040	31,70	TTD-3F04-3170-HP358	30530466
24,50	TTD-3F04-2450-HP358	30530444	32,00	TTD-3F04-3200-HP358	30530467
24,70	TTD-3F04-2470-HP358	30530445	33,00	TTD-3F04-3300-HP358	30530469
24,80	TTD-3F04-2480-HP358	30597042	34,00	TTD-3F04-3400-HP358	30530471
25,00	TTD-3F04-2500-HP358	30530446	34,50	TTD-3F04-3450-HP358	30530472
25,20	TTD-3F04-2520-HP358	30597045	35,00	TTD-3F04-3500-HP358	30530473
25,30	TTD-3F04-2530-HP358	30597046	36,00	TTD-3F04-3600-HP358	30530475
25,40	TTD-3F04-2540-HP358	30597047	37,00	TTD-3F04-3700-HP358	30530477
25,50	TTD-3F04-2550-HP358	30530447	38,00	TTD-3F04-3800-HP358	30530479
25,90	TTD-3F04-2590-HP358	30597050	39,00	TTD-3F04-3900-HP358	30530481
26,00	TTD-3F04-2600-HP358	30530449	40,00	TTD-3F04-4000-HP358	30530483
26,10	TTD-3F04-2610-HP358	30597051	41,00	TTD-3F04-4100-HP358	30530485

Możliwość konfiguracji parametrów

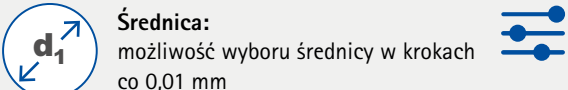

Średnica:
możliwość wyboru średnicy w krokach
co 0,01 mm

Specyfikacja:
TTD-3F04-[średnica]-HP358

Wymiary typoszeregu z możliwością konfiguracji parametrów

d ₁ min.	d ₁ maks.
12,00	45,00

Przykład:
TTD-3F04-1401-HP358

Średnica narzędzia d₁ = 14,01 mm

Wymiary podano w mm.

Zalecane parametry skrawania – patrz koniec rozdziału.

Wersje specjalne i inne powłoki wg zapytania ofertowego.

Wymienna głowica TTD

Z węgla spiekane, wewnętrzne doprowadzenie chłodziwa
Typ 02 – Inox

Wersja:

Średnica wiertła: 12,00 – 45,00 mm

Tolerancja otworu: $\geq IT 9$

Materiał skrawający: HP385

Liczba ostrzy: 2

Liczba tyśinek: 3

Kąt wierzchołkowy: 138°

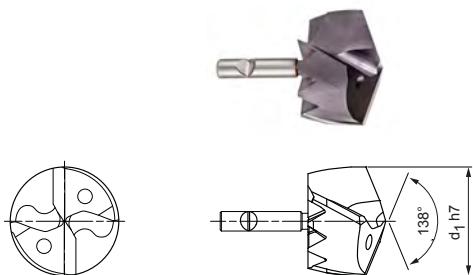

Magazynowa seria preferowana

d ₁ od 12,00 do 16,40		
d ₁ h7	Specyfikacja	Nr materiałowy
12,00	TTD-3F02-1200-HP385	30231780
12,10	TTD-3F02-1210-HP385	30248920
12,20	TTD-3F02-1220-HP385	30248921
12,40	TTD-3F02-1240-HP385	30248923
12,50	TTD-3F02-1250-HP385	30231784
12,60	TTD-3F02-1260-HP385	30248924
12,70	TTD-3F02-1270-HP385	30231787
13,00	TTD-3F02-1300-HP385	30231791
13,10	TTD-3F02-1310-HP385	30248927
13,50	TTD-3F02-1350-HP385	30231792
13,80	TTD-3F02-1380-HP385	30248932
14,00	TTD-3F02-1400-HP385	30231795
14,10	TTD-3F02-1410-HP385	30239446
14,20	TTD-3F02-1420-HP385	30248934
14,30	TTD-3F02-1430-HP385	30248935
14,40	TTD-3F02-1440-HP385	30248936
14,50	TTD-3F02-1450-HP385	30231802
14,60	TTD-3F02-1460-HP385	30248937
14,70	TTD-3F02-1470-HP385	30231804
14,80	TTD-3F02-1480-HP385	30248938
15,00	TTD-3F02-1500-HP385	30231805
15,10	TTD-3F02-1510-HP385	30248940
15,30	TTD-3F02-1530-HP385	30248942
15,50	TTD-3F02-1550-HP385	30231806
15,60	TTD-3F02-1560-HP385	30248944
15,70	TTD-3F02-1570-HP385	30219115
15,80	TTD-3F02-1580-HP385	30248945
15,90	TTD-3F02-1590-HP385	30248946
16,00	TTD-3F02-1600-HP385	30191427
16,10	TTD-3F02-1610-HP385	30248947
16,20	TTD-3F02-1620-HP385	30248948
16,30	TTD-3F02-1630-HP385	30248949
16,40	TTD-3F02-1640-HP385	30248950

d ₁ od 16,50 do 21,00		
d ₁ h7	Specyfikacja	Nr materiałowy
16,50	TTD-3F02-1650-HP385	30191428
16,60	TTD-3F02-1660-HP385	30248951
16,70	TTD-3F02-1670-HP385	30219122
16,80	TTD-3F02-1680-HP385	30248952
17,00	TTD-3F02-1700-HP385	30191429
17,50	TTD-3F02-1750-HP385	30191430
17,60	TTD-3F02-1760-HP385	30248958
17,70	TTD-3F02-1770-HP385	30219123
17,80	TTD-3F02-1780-HP385	30248959
18,00	TTD-3F02-1800-HP385	30191431
18,20	TTD-3F02-1820-HP385	30248962
18,30	TTD-3F02-1830-HP385	30248963
18,50	TTD-3F02-1850-HP385	30191432
18,60	TTD-3F02-1860-HP385	30248965
18,80	TTD-3F02-1880-HP385	30248966
18,90	TTD-3F02-1890-HP385	30248967
19,00	TTD-3F02-1900-HP385	30191433
19,10	TTD-3F02-1910-HP385	30248968
19,20	TTD-3F02-1920-HP385	30248969
19,30	TTD-3F02-1930-HP385	30248970
19,40	TTD-3F02-1940-HP385	30248971
19,50	TTD-3F02-1950-HP385	30191434
19,70	TTD-3F02-1970-HP385	30219125
19,80	TTD-3F02-1980-HP385	30248973
19,90	TTD-3F02-1990-HP385	30248974
20,00	TTD-3F02-2000-HP385	30191435
20,10	TTD-3F02-2010-HP385	30248975
20,20	TTD-3F02-2020-HP385	30248976
20,30	TTD-3F02-2030-HP385	30248977
20,40	TTD-3F02-2040-HP385	30248978
20,50	TTD-3F02-2050-HP385	30191436
20,70	TTD-3F02-2070-HP385	30219126
21,00	TTD-3F02-2100-HP385	30191437

Wymienne głowice TTD z węgla spiekane, wewnętrzne doprowadzenie chłodziwa – typ O2

d ₁ od 21,20 do 25,80			d ₁ od 26,00 do 38,50		
d ₁ h7	Specyfikacja	Nr materiałowy	d ₁ h7	Specyfikacja	Nr materiałowy
21,20	TTD-3F02-2120-HP385	30248982	26,00	TTD-3F02-2600-HP385	30191447
21,50	TTD-3F02-2150-HP385	30191438	26,50	TTD-3F02-2650-HP385	30191448
21,70	TTD-3F02-2170-HP385	30219127	26,80	TTD-3F02-2680-HP385	30249020
21,80	TTD-3F02-2180-HP385	30248986	27,00	TTD-3F02-2700-HP385	30191449
22,00	TTD-3F02-2200-HP385	30191439	27,10	TTD-3F02-2710-HP385	30249022
22,10	TTD-3F02-2210-HP385	30248988	27,40	TTD-3F02-2740-HP385	30249025
22,40	TTD-3F02-2240-HP385	30248990	27,50	TTD-3F02-2750-HP385	30191450
22,50	TTD-3F02-2250-HP385	30191440	28,00	TTD-3F02-2800-HP385	30191451
22,60	TTD-3F02-2260-HP385	30248991	28,10	TTD-3F02-2810-HP385	30249029
22,70	TTD-3F02-2270-HP385	30219128	28,20	TTD-3F02-2820-HP385	30249030
22,80	TTD-3F02-2280-HP385	30248992	28,50	TTD-3F02-2850-HP385	30191452
22,90	TTD-3F02-2290-HP385	30248993	28,60	TTD-3F02-2860-HP385	30249033
23,00	TTD-3F02-2300-HP385	30191441	28,70	TTD-3F02-2870-HP385	30219134
23,50	TTD-3F02-2350-HP385	30191442	29,00	TTD-3F02-2900-HP385	30191453
23,70	TTD-3F02-2370-HP385	30219129	29,50	TTD-3F02-2950-HP385	30191454
24,00	TTD-3F02-2400-HP385	30191443	29,70	TTD-3F02-2970-HP385	30219135
24,20	TTD-3F02-2420-HP385	30249002	29,80	TTD-3F02-2980-HP385	30249041
24,40	TTD-3F02-2440-HP385	30249004	29,90	TTD-3F02-2990-HP385	30249042
24,50	TTD-3F02-2450-HP385	30191444	30,00	TTD-3F02-3000-HP385	30191455
24,70	TTD-3F02-2470-HP385	30219130	30,10	TTD-3F02-3010-HP385	30249043
24,80	TTD-3F02-2480-HP385	30249006	30,30	TTD-3F02-3030-HP385	30249045
25,00	TTD-3F02-2500-HP385	30191445	31,00	TTD-3F02-3100-HP385	30191457
25,20	TTD-3F02-2520-HP385	30249009	31,30	TTD-3F02-3130-HP385	30249052
25,30	TTD-3F02-2530-HP385	30249010	31,50	TTD-3F02-3150-HP385	30191458
25,40	TTD-3F02-2540-HP385	30249011	31,80	TTD-3F02-3180-HP385	30249055
25,50	TTD-3F02-2550-HP385	30191446	32,00	TTD-3F02-3200-HP385	30191459
25,70	TTD-3F02-2570-HP385	30219131	38,50	TTD-3F02-3850-HP385	30322384
25,80	TTD-3F02-2580-HP385	30249013			

Możliwość konfiguracji parametrów

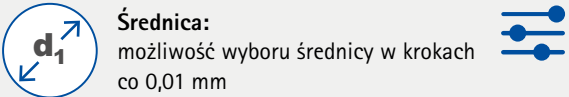

Średnica:
możliwość wyboru średnicy w krokach
co 0,01 mm

Specyfikacja:
TTD-3F02-[średnica]-HP358

Wymiary typoszeregu z możliwością konfiguracji parametrów

d ₁ min.	d ₁ maks.
12,00	45,00

Przykład:
TTD-3F02-1401-HP358

Średnica narzędzia d₁ = 14,01 mm

Wymiary podano w mm.

Zalecane parametry skrawania – patrz koniec rozdziału.

Wersje specjalne i inne powłoki wg zapytania ofertowego.

Wymienna głowica TTD

Z węgla spiekane, wewnętrzne doprowadzenie chłodziwa
Typ 05 – Iron

Wersja:

Średnica wiertła: 12,00 – 45,00 mm
Tolerancja otworu: \geq IT 9
Materiał skrawający: HP240
Liczba ostrzy: 2
Liczba tyśinek: 4
Kąt wierzchołkowy: 140°

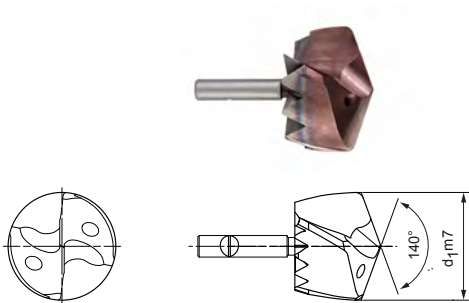

Magazynowa seria preferowana

d ₁ od 12,50 do 20,80		
d ₁ m7	Specyfikacja	Nr materiałowy
12,50	TTD-4F05-1250-HP240	30597144
12,70	TTD-4F05-1270-HP240	30597146
14,00	TTD-4F05-1400-HP240	30597159
14,50	TTD-4F05-1450-HP240	30597164
15,30	TTD-4F05-1530-HP240	30597173
15,70	TTD-4F05-1570-HP240	30597177
16,30	TTD-4F05-1630-HP240	30597183
16,50	TTD-4F05-1650-HP240	30597185
16,70	TTD-4F05-1670-HP240	30597187
16,80	TTD-4F05-1680-HP240	30597188
17,00	TTD-4F05-1700-HP240	30597190
17,10	TTD-4F05-1710-HP240	30597191
17,50	TTD-4F05-1750-HP240	30597195
18,00	TTD-4F05-1800-HP240	30597200
18,20	TTD-4F05-1820-HP240	30597202
18,50	TTD-4F05-1850-HP240	30597205
18,60	TTD-4F05-1860-HP240	30597206
18,80	TTD-4F05-1880-HP240	30597208
19,00	TTD-4F05-1900-HP240	30597210
19,70	TTD-4F05-1970-HP240	30597217
20,50	TTD-4F05-2050-HP240	30597225
20,70	TTD-4F05-2070-HP240	30597227
20,80	TTD-4F05-2080-HP240	30597228

d ₁ od 21,00 do 37,00		
d ₁ m7	Specyfikacja	Nr materiałowy
21,00	TTD-4F05-2100-HP240	30597230
21,10	TTD-4F05-2110-HP240	30597231
21,50	TTD-4F05-2150-HP240	30597235
21,70	TTD-4F05-2170-HP240	30597237
22,00	TTD-4F05-2200-HP240	30597240
22,10	TTD-4F05-2210-HP240	30597241
22,30	TTD-4F05-2230-HP240	30597243
22,70	TTD-4F05-2270-HP240	30597247
23,00	TTD-4F05-2300-HP240	30597250
23,50	TTD-4F05-2350-HP240	30597255
24,00	TTD-4F05-2400-HP240	30597260
24,40	TTD-4F05-2440-HP240	30597264
24,80	TTD-4F05-2480-HP240	30597268
25,00	TTD-4F05-2500-HP240	30597270
25,80	TTD-4F05-2580-HP240	30597278
26,00	TTD-4F05-2600-HP240	30597280
27,00	TTD-4F05-2700-HP240	30597290
27,10	TTD-4F05-2710-HP240	30597291
28,00	TTD-4F05-2800-HP240	30597300
28,50	TTD-4F05-2850-HP240	30597305
30,00	TTD-4F05-3000-HP240	30597320
32,00	TTD-4F05-3200-HP240	30597341
37,00	TTD-4F05-3700-HP240	30597351

Możliwość konfiguracji parametrów



Średnica:
możliwość wyboru średnicy w krokach co 0,01 mm

Specyfikacja:
TTD-4F05-[średnica]-HP240

Wymiary podano w mm.
Zalecane parametry skrawania - patrz koniec rozdziału.
Wersje specjalne i inne powłoki wg zapytania ofertowego.

Wymiary typoszeregu z możliwością konfiguracji parametrów

d ₁ min.	d ₁ maks.
12,00	45,00

Przykład:
TTD-4F05-1401-HP619

Średnica narzędzia d₁ = 14,01 mm

Wymienna głowica TTD

Z węgla spiekane, wewnętrzne doprowadzenie chłodziwa
Typ 03 – Alu

Wersja:

Średnica wiertła: 12,00 – 45,00 mm
Tolerancja otworu: \geq IT 9
Materiał skrawający: HP685
Liczba ostrzy: 2
Liczba tyśinek: 4
Kąt wierzchołkowy: 140°

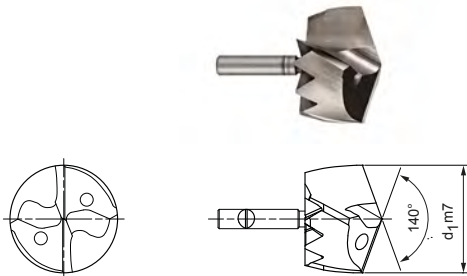

Magazynowa seria preferowana

d ₁ od 12,10 do 21,00		
d ₁ m7	Specyfikacja	Nr materiałowy
12,10	TTD-4F03-1210-HP685	30249057
12,50	TTD-4F03-1250-HP685	30231808
12,80	TTD-4F03-1280-HP685	30249062
13,00	TTD-4F03-1300-HP685	30231812
13,50	TTD-4F03-1350-HP685	30231815
14,00	TTD-4F03-1400-HP685	30231817
14,50	TTD-4F03-1450-HP685	30231818
14,70	TTD-4F03-1470-HP685	30231819
14,90	TTD-4F03-1490-HP685	30249077
15,00	TTD-4F03-1500-HP685	30231820
16,00	TTD-4F03-1600-HP685	30191460
16,10	TTD-4F03-1610-HP685	30249085
16,50	TTD-4F03-1650-HP685	30191461
17,00	TTD-4F03-1700-HP685	30191462
17,50	TTD-4F03-1750-HP685	30191463
18,00	TTD-4F03-1800-HP685	30191464
18,10	TTD-4F03-1810-HP685	30234210
18,20	TTD-4F03-1820-HP685	30249099
18,30	TTD-4F03-1830-HP685	30249100
18,50	TTD-4F03-1850-HP685	30191465
18,60	TTD-4F03-1860-HP685	30249102
18,70	TTD-4F03-1870-HP685	30219141
19,00	TTD-4F03-1900-HP685	30191466
19,50	TTD-4F03-1950-HP685	30191467
19,60	TTD-4F03-1960-HP685	30249109
20,00	TTD-4F03-2000-HP685	30191468
20,30	TTD-4F03-2030-HP685	30216431
20,50	TTD-4F03-2050-HP685	30191469
21,00	TTD-4F03-2100-HP685	30191470

d ₁ od 21,50 do 43,00		
d ₁ m7	Specyfikacja	Nr materiałowy
21,50	TTD-4F03-2150-HP685	30191471
22,00	TTD-4F03-2200-HP685	30191472
22,50	TTD-4F03-2250-HP685	30191473
22,60	TTD-4F03-2260-HP685	30249129
23,00	TTD-4F03-2300-HP685	30191474
23,50	TTD-4F03-2350-HP685	30191475
23,90	TTD-4F03-2390-HP685	30249138
24,00	TTD-4F03-2400-HP685	30191476
24,10	TTD-4F03-2410-HP685	30249139
24,40	TTD-4F03-2440-HP685	30249142
24,50	TTD-4F03-2450-HP685	30191477
25,00	TTD-4F03-2500-HP685	30191478
25,10	TTD-4F03-2510-HP685	30249146
25,20	TTD-4F03-2520-HP685	30249147
25,50	TTD-4F03-2550-HP685	30191479
26,00	TTD-4F03-2600-HP685	30191480
26,40	TTD-4F03-2640-HP685	30249156
27,00	TTD-4F03-2700-HP685	30191482
27,50	TTD-4F03-2750-HP685	30191483
28,00	TTD-4F03-2800-HP685	30191484
28,30	TTD-4F03-2830-HP685	30249169
28,40	TTD-4F03-2840-HP685	30249170
29,50	TTD-4F03-2950-HP685	30191487
31,00	TTD-4F03-3100-HP685	30191490
31,20	TTD-4F03-3120-HP685	30249189
32,00	TTD-4F03-3200-HP685	30191492
35,00	TTD-4F03-3500-HP685	30322405
43,00	TTD-4F03-4300-HP685	30322423

Możliwość konfiguracji parametrów



Średnica:
możliwość wyboru średnicy w
krokach co 0,01 mm



Specyfikacja:

TTD-4F03-[średnica]-HP685

Wymiary typoszeregu z możliwością konfiguracji parametrów

d ₁ min.	d ₁ maks.
12.00	45.00

Przykład:

TTD-4F03-1401-HP685

Średnica narzędzia d₁ = 14,01 mm

Wymiary podano w mm.

Zalecane parametry skrawania - patrz koniec rozdziału.

Wersje specjalne i inne powłoki wg zapytania ofertowego.

Uchwyt wymiennej głowicy TTS

Z systemem mocowania od przodu do wiertła z wymienną głowicą TTD
TTS100, wewnętrzne doprowadzenie chłodziwa

Wersja:

Do średnicy wiertła: 12,00 - 45,49 mm

System wymiany płytki: System mocowania z przodu
Możliwość wymiany głowicy w maszynie

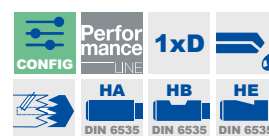
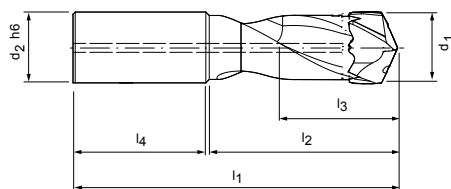

Magazynowa seria preferowana

Wymiary							Typ chwytu HB	
d ₁	Złącze	d ₂ h6	l ₁	l ₂	l ₃	l ₄	Specyfikacja	Nr materiałowy
12,00-12,49	TTS12-S	14	81	29	13	45	TTS100-12-DR1-1200-14-HB	30324304
12,50-12,99	TTS12-S	14	81	29	13	45	TTS100-12-DR1-1250-14-HB	30324305
13,00-13,49	TTS12-S	14	81	31	14	45	TTS100-12-DR1-1300-14-HB	30324306
13,50-13,99	TTS12-S	16	86	32	14	48	TTS100-12-DR1-1350-16-HB	30324307
14,00-14,49	TTS12-S	16	86	33	15	48	TTS100-12-DR1-1400-16-HB	30324308
14,50-14,99	TTS12-S	16	91	34	15	48	TTS100-12-DR1-1450-16-HB	30324309
15,00-15,49	TTS12-S	16	91	36	16	48	TTS100-12-DR1-1500-16-HB	30324310
15,50-16,49	TTS12-S	18	92	38	17	48	TTS100-12-DR1-1550-18-HB	30324311
16,50-17,49	TTS12-S	18	94	40	18	48	TTS100-12-DR1-1650-18-HB	30324312
17,50-18,49	TTS12-S	18	99	43	19	48	TTS100-12-DR1-1750-18-HB	30324313
18,50-19,49	TTS12-S	20	99	45	20	50	TTS100-12-DR1-1850-20-HB	30324314
19,50-20,49	TTS12-S	20	104	47	21	50	TTS100-12-DR1-1950-20-HB	30324316
20,50-21,49	TTS12-S	25	111	49	22	56	TTS100-12-DR1-2050-25-HB	30324317
21,50-22,49	TTS12-S	25	116	52	23	56	TTS100-12-DR1-2150-25-HB	30324318
22,50-23,49	TTS12-S	25	116	54	24	56	TTS100-12-DR1-2250-25-HB	30324319
23,50-24,49	TTS12-S	25	121	56	25	56	TTS100-12-DR1-2350-25-HB	30324320
24,50-25,49	TTS18-S	25	123	59	26	56	TTS100-18-DR1-2450-25-HB	30324321
25,50-26,49	TTS18-S	25	123	61	27	56	TTS100-18-DR1-2550-25-HB	30324322
26,50-27,49	TTS18-S	25	128	63	28	56	TTS100-18-DR1-2650-25-HB	30324323
27,50-28,49	TTS18-S	25	128	66	29	56	TTS100-18-DR1-2750-25-HB	30324325
28,50-29,49	TTS18-S	32	134	68	30	60	TTS100-18-DR1-2850-32-HB	30324327
29,50-30,49	TTS18-S	32	139	70	31	60	TTS100-18-DR1-2950-32-HB	30324328
30,50-31,49	TTS18-S	32	139	75	32	60	TTS100-18-DR1-3050-32-HB	30324329
31,50-32,49	TTS18-S	32	139	75	33	60	TTS100-18-DR1-3150-32-HB	30324330
32,50-33,49	TTS18-S	32	150	78	34	60	TTS100-18-DR1-3250-32-HB	30374587
33,50-34,49	TTS18-S	32	150	79	35	60	TTS100-18-DR1-3350-32-HB	30374590
34,50-35,49	TTS12-S	32	152	86	36	60	TTS100-18-DR1-3550-32-HB	30496703
34,50-35,49	TTS18-S	32	150	82	36	60	TTS100-18-DR1-3450-32-HB	30374593
35,50-37,49	TTS18-S	40	162	86	38	70	TTS100-18-DR1-3550-40-HB	30535302
37,50-39,49	TTS18-S	32	157	91	40	60	TTS100-18-DR1-3750-32-HB	30496704
37,50-39,49	TTS18-S	40	167	71	40	70	TTS100-18-DR1-3750-40-HB	30535303

ciąg dalszy na następnej stronie.

Uchwyty wymiennej głowicy TTS 100, wewnętrzne doprowadzenie chłodziwa

Wymiary							Typ chwytu HB	
d ₁	Złącze	d ₂ h6	l ₁	l ₂	l ₃	l ₄	Specyfikacja	Nr materiałowy
39,50-41,49	TTS18-S	32	167	95	42	60	TTS100-18-DR1-3950-32-HB	30496705
39,50-41,49	TTS18-S	40	177	95	42	70	TTS100-18-DR1-3950-40-HB	30535305
41,50-43,49	TTS18-S	40	180	100	44	70	TTS100-18-DR1-4150-40-HB	30535307
43,50-45,49	TTS18-S	40	185	105	46	70	TTS100-18-DR1-4350-40-HB	30535312

Możliwość konfiguracji parametrów



Typ chwytu:
Typ chwytu: HA | HE



Specyfikacja:
TTS100-18-DR1-4150-40-[typ chwytu]

Przykład:

TTS100-18-DR1-4150-40-HE

Typ chwytu HE

Uchwyt wymiennej głowicy TTS

Z systemem mocowania od przodu do wiertła z wymienną głowicą TTD
TTS100 (3xD), wewnętrzne doprowadzenie chłodziwa

Wersja:

Do średnicy wiertła: 12,00 - 45,49 mm

System wymiany płytki: System mocowania z przodu
Możliwość wymiany
głowicy w maszynie

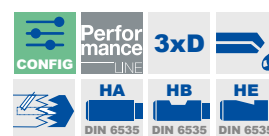
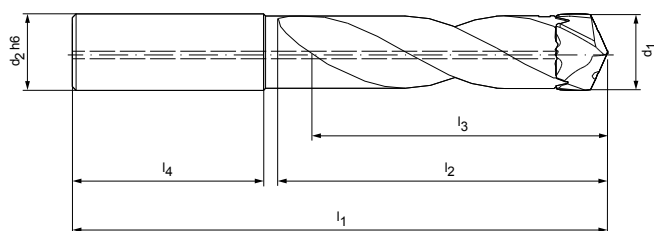

Magazynowa seria preferowana

Wymiary							Typ chwytu HB	
d ₁	Złącze	d ₂ h6	l ₁	l ₂	l ₃	l ₄	Specyfikacja	Nr materiałowy
12,00-12,49	TTS12-S	14	100	53	38	45	TTS100-12-DR3-1200-14-HB	30232785
12,50-12,99	TTS12-S	14	105	55	39	45	TTS100-12-DR3-1250-14-HB	30232787
13,00-13,49	TTS12-S	14	105	57	41	45	TTS100-12-DR3-1300-14-HB	30232789
13,50-13,99	TTS12-S	16	110	59	42	48	TTS100-12-DR3-1350-16-HB	30232790
14,00-14,49	TTS12-S	16	115	61	44	48	TTS100-12-DR3-1400-16-HB	30232792
14,50-14,99	TTS12-S	16	115	63	45	48	TTS100-12-DR3-1450-16-HB	30232793
15,00-15,49	TTS12-S	16	115	65	47	48	TTS100-12-DR3-1500-16-HB	30232794
15,50-16,49	TTS12-S	18	120	70	50	48	TTS100-12-DR3-1550-18-HB	30191496
16,50-17,49	TTS12-S	18	125	74	53	48	TTS100-12-DR3-1650-18-HB	30191497
17,50-18,49	TTS12-S	18	130	78	56	48	TTS100-12-DR3-1750-18-HB	30191498
18,50-19,49	TTS12-S	20	135	82	59	50	TTS100-12-DR3-1850-20-HB	30191499
19,50-20,49	TTS12-S	20	140	87	62	50	TTS100-12-DR3-1950-20-HB	30191500
20,50-21,49	TTS12-S	25	150	91	65	56	TTS100-12-DR3-2050-25-HB	30191501
21,50-22,49	TTS12-S	25	155	95	68	56	TTS100-12-DR3-2150-25-HB	30191502
22,50-23,49	TTS12-S	25	160	99	71	56	TTS100-12-DR3-2250-25-HB	30191503
23,50-24,49	TTS12-S	25	165	103	74	56	TTS100-12-DR3-2350-25-HB	30191504
24,50-25,49	TTS18-S	25	165	108	77	56	TTS100-18-DR3-2450-25-HB	30191505
25,50-26,49	TTS18-S	25	175	112	80	56	TTS100-18-DR3-2550-25-HB	30191507
26,50-27,49	TTS18-S	25	175	116	83	56	TTS100-18-DR3-2650-25-HB	30191508
27,50-28,49	TTS18-S	25	180	120	86	56	TTS100-18-DR3-2750-25-HB	30191509
28,50-29,49	TTS18-S	32	190	124	89	60	TTS100-18-DR3-2850-32-HB	30191510
29,50-30,49	TTS18-S	32	195	129	92	60	TTS100-18-DR3-2950-32-HB	30191511
30,50-31,49	TTS18-S	32	195	133	95	60	TTS100-18-DR3-3050-32-HB	30191512
31,50-32,49	TTS18-S	32	200	137	98	60	TTS100-18-DR3-3150-32-HB	30191513
32,50-33,49	TTS18-S	32	210	144	101	60	TTS100-18-DR3-3250-32-HB	30322289
33,50-34,49	TTS18-S	32	215	148	104	60	TTS100-18-DR3-3350-32-HB	30322290
34,50-35,49	TTS18-S	32	227	161	107	60	TTS100-18-DR3-3550-32-HB	30496706
34,50-35,49	TTS18-S	32	220	153	107	60	TTS100-18-DR3-3450-32-HB	30322291
35,50-37,49	TTS18-S	40	237	161	113	70	TTS100-18-DR3-3550-40-HB	30535313
37,50-39,49	TTS18-S	32	237	170	119	60	TTS100-18-DR3-3750-32-HB	30496707
37,50-39,49	TTS18-S	40	247	170	119	70	TTS100-18-DR3-3750-40-HB	30535316
39,50-41,49	TTS18-S	32	247	178	125	60	TTS100-18-DR3-3950-32-HB	30496708

ciąg dalszy na następnej stronie.

Uchwyty wymiennej głowicy TTS 100 (3xD), wewnętrzne doprowadzenie chłodziwa

Wymiary							Typ chwytu HB	
d ₁	Złącze	d ₂ h6	l ₁	l ₂	l ₃	l ₄	Specyfikacja	Nr materiałowy
39,50-41,49	TTS18-S	40	257	178	125	70	TTS100-18-DR3-3950-40-HB	30535318
41,50-43,49	TTS18-S	40	265	187	131	70	TTS100-18-DR3-4150-40-HB	30535320
43,50-45,49	TTS18-S	40	275	196	137	70	TTS100-18-DR3-4350-40-HB	30535321

Możliwość konfiguracji parametrów



Typ chwytu:
Typ chwytu: HA | HE



Specyfikacja:
TTS100-18-DR5-4150-40-[typ chwytu]

Przykład:

TTS100-18-DR5-4150-40-HE

Typ chwytu HE

Uchwyt wymiennej głowicy TTS

Z systemem mocowania od przodu do wiertła z wymienną głowicą TTD
TTS100 (5xD), wewnętrzne doprowadzenie chłodziwa

Wersja:

Do średnicy wiertła: 12,00 - 45,49 mm

System wymiany płytki: System mocowania z przodu
Możliwość wymiany głowicy w maszynie

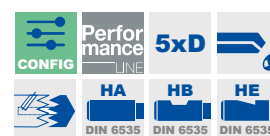
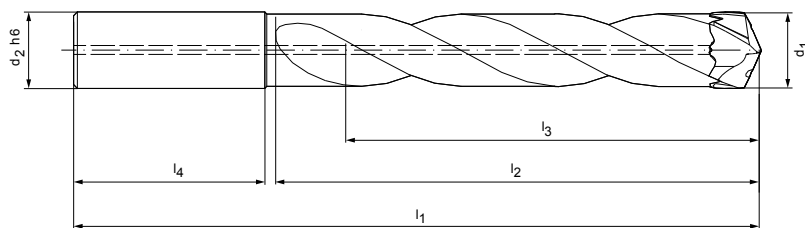

Magazynowa seria preferowana

Wymiary							Typ chwytu HB	
d ₁	Złącze	d ₂ h6	l ₁	l ₂	l ₃	l ₄	Specyfikacja	Nr materiałowy
12,00-12,49	TTS12-S	14	125	78	63	45	TTS100-12-DR5-1200-14-HB	30232796
12,50-12,99	TTS12-S	14	130	81	65	45	TTS100-12-DR5-1250-14-HB	30232798
13,00-13,49	TTS12-S	14	130	84	68	45	TTS100-12-DR5-1300-14-HB	30232799
13,50-13,99	TTS12-S	16	140	88	70	48	TTS100-12-DR5-1350-16-HB	30232800
14,00-14,49	TTS12-S	16	140	90	73	48	TTS100-12-DR5-1400-16-HB	30232801
14,50-14,99	TTS12-S	16	145	94	75	48	TTS100-12-DR5-1450-16-HB	30232802
15,00-15,49	TTS12-S	16	145	96	78	48	TTS100-12-DR5-1500-16-HB	30232803
15,50-16,49	TTS12-S	18	155	103	83	48	TTS100-12-DR5-1550-18-HB	30191514
16,50-17,49	TTS12-S	18	160	109	88	48	TTS100-12-DR5-1650-18-HB	30191515
17,50-18,49	TTS12-S	18	165	115	93	48	TTS100-12-DR5-1750-18-HB	30191516
18,50-19,49	TTS12-S	20	175	121	98	50	TTS100-12-DR5-1850-20-HB	30191517
19,50-20,49	TTS12-S	20	180	128	103	50	TTS100-12-DR5-1950-20-HB	30191518
20,50-21,49	TTS12-S	25	195	134	108	56	TTS100-12-DR5-2050-25-HB	30191519
21,50-22,49	TTS12-S	25	200	140	113	56	TTS100-12-DR5-2150-25-HB	30191520
22,50-23,49	TTS12-S	25	205	146	118	56	TTS100-12-DR5-2250-25-HB	30191521
23,50-24,49	TTS12-S	25	210	152	123	56	TTS100-12-DR5-2350-25-HB	30191522
24,50-25,49	TTS18-S	25	220	159	128	56	TTS100-18-DR5-2450-25-HB	30191523
25,50-26,49	TTS18-S	25	225	165	133	56	TTS100-18-DR5-2550-25-HB	30191525
26,50-27,49	TTS18-S	25	230	171	138	56	TTS100-18-DR5-2650-25-HB	30191526
27,50-28,49	TTS18-S	25	240	177	143	56	TTS100-18-DR5-2750-25-HB	30191527
28,50-29,49	TTS18-S	32	250	183	148	60	TTS100-18-DR5-2850-32-HB	30191528
29,50-30,49	TTS18-S	32	255	190	153	60	TTS100-18-DR5-2950-32-HB	30191529
30,50-31,49	TTS18-S	32	260	196	158	60	TTS100-18-DR5-3050-32-HB	30191530
31,50-32,49	TTS18-S	32	265	202	163	60	TTS100-18-DR5-3150-32-HB	30191531
32,50-33,49	TTS18-S	32	275	210	168	60	TTS100-18-DR5-3250-32-HB	30322313
33,50-34,49	TTS18-S	32	285	217	173	60	TTS100-18-DR5-3350-32-HB	30322314
34,50-35,49	TTS18-S	32	290	224	178	60	TTS100-18-DR5-3450-32-HB	30322315
35,50-37,49	TTS18-S	32	302	236	188	60	TTS100-18-DR5-3550-32-HB	30496709
*35,50-37,49	TTS18-S	40	312	236	188	70	TTS100-18-DR5-3550-40-HB	30535324
37,50-39,49	TTS18-S	32	317	249	198	60	TTS100-18-DR5-3750-32-HB	30496710
*37,50-39,49	TTS18-S	40	327	249	198	70	TTS100-18-DR5-3750-40-HB	30534860

ciąg dalszy na następnej stronie.

Uchwyty wymiennej głowicy TTS 100 (5xD), wewnętrzne doprowadzenie chłodziwa

Wymiary							Typ chwytu HB	
d ₁	Złącze	d ₂ h6	l ₁	l ₂	l ₃	l ₄	Specyfikacja	Nr materiałowy
39,50-41,49	TTS18-S	32	327	261	208	60	TTS100-18-DR5-3950-32-HB	30496711
*39,50-41,49	TTS18-S	40	337	261	208	70	TTS100-18-DR5-3950-40-HB	30535326
*41,50-43,49	TTS18-S	40	350	274	218	70	TTS100-18-DR5-4150-40-HB	30535327
*43,50-45,49	TTS18-S	40	365	287	228	70	TTS100-18-DR5-4350-40-HB	30535328

Możliwość konfiguracji parametrów



Typ chwytu:
Typ chwytu: HA | HE



Specyfikacja:
TTS100-18-DR5-4150-40-[typ chwytu]

Przykład:

TTS100-18-DR5-4150-40-HE

Typ chwytu HE

Uchwyt wymiennej głowicy TTS

Z systemem mocowania od przodu do wiertła z wymienną głowicą TTD
TTS100 (8xD), wewnętrzne doprowadzenie chłodziwa

Wersja:

Do średnicy wiertła: 12,00 – 45,49 mm

System wymiany płytki: System mocowania z przodu
Możliwość wymiany głowicy w maszynie

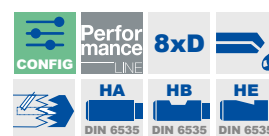
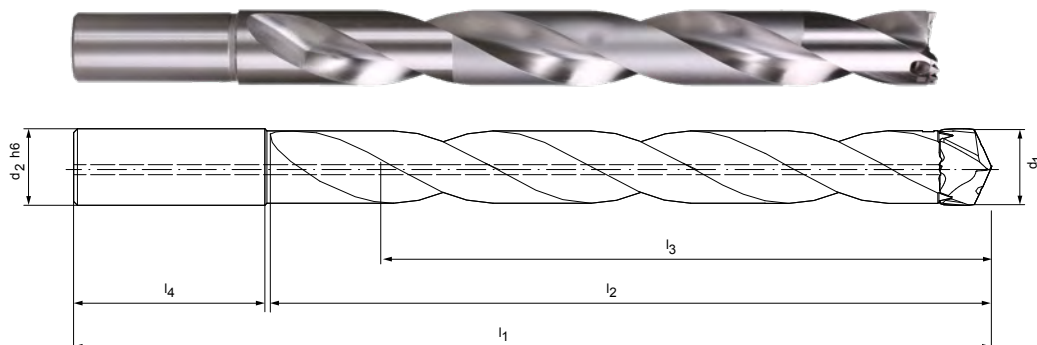

Magazynowa seria preferowana

Wymiary							Typ chwytu HB	
d ₁	Złącze	d ₂ h6	l ₁	l ₂	l ₃	l ₄	Specyfikacja	Nr materiałowy
12,00-12,49	TTS12-S	14	165	116	100	45	TTS100-12-DR8-1200-14-HB	30232805
12,50-12,99	TTS12-S	14	170	121	104	45	TTS100-12-DR8-1250-14-HB	30232806
13,00-13,49	TTS12-S	14	175	126	108	45	TTS100-12-DR8-1300-14-HB	30232807
13,50-13,99	TTS12-S	16	180	129	112	48	TTS100-12-DR8-1350-16-HB	30232808
14,00-14,49	TTS12-S	16	185	134	116	48	TTS100-12-DR8-1400-16-HB	30232809
14,50-14,99	TTS12-S	16	190	139	120	48	TTS100-12-DR8-1450-16-HB	30232810
15,00-15,49	TTS12-S	16	195	144	124	48	TTS100-12-DR8-1500-16-HB	30232811
15,50-16,49	TTS12-S	18	205	152	132	48	TTS100-12-DR8-1550-18-HB	30191532
16,50-17,49	TTS12-S	18	215	161	140	48	TTS100-12-DR8-1650-18-HB	30191533
17,50-18,49	TTS12-S	18	220	171	148	48	TTS100-12-DR8-1750-18-HB	30191534
18,50-19,49	TTS12-S	20	235	180	156	50	TTS100-12-DR8-1850-20-HB	30191535
19,50-20,49	TTS12-S	20	240	189	164	50	TTS100-12-DR8-1950-20-HB	30191536
20,50-21,49	TTS12-S	25	260	198	172	56	TTS100-12-DR8-2050-25-HB	30191537
21,50-22,49	TTS12-S	25	270	207	180	56	TTS100-12-DR8-2150-25-HB	30191538
22,50-23,49	TTS12-S	25	275	217	188	56	TTS100-12-DR8-2250-25-HB	30191539
23,50-24,49	TTS12-S	25	285	226	196	56	TTS100-12-DR8-2350-25-HB	30191540
24,50-25,49	TTS18-S	25	295	235	204	56	TTS100-18-DR8-2450-25-HB	30191541
25,50-26,49	TTS18-S	25	305	244	212	56	TTS100-18-DR8-2550-25-HB	30191543
26,50-27,49	TTS18-S	25	315	253	220	56	TTS100-18-DR8-2650-25-HB	30191544
27,50-28,49	TTS18-S	25	325	263	228	56	TTS100-18-DR8-2750-25-HB	30191545
28,50-29,49	TTS18-S	32	340	272	236	60	TTS100-18-DR8-2850-32-HB	30191546
29,50-30,49	TTS18-S	32	345	281	244	60	TTS100-18-DR8-2950-32-HB	30191547
30,50-31,49	TTS18-S	32	355	290	252	60	TTS100-18-DR8-3050-32-HB	30191548
31,50-32,49	TTS18-S	32	360	299	260	60	TTS100-18-DR8-3150-32-HB	30191549
32,50 - 33,49	TTS18-S	32	375	275	268	60	TTS100-18-DR8-3250-32-HB	30809129
33,50 - 34,49	TTS18-S	32	385	317	276	60	TTS100-18-DR8-3350-32-HB	30809654
34,50 - 35,49	TTS18-S	32	395	329	284	60	TTS100-18-DR8-3450-32-HB	30809664
35,50 - 37,49	TTS18-S	32	402	336	300	60	TTS100-18-DR8-3550-32-HB	30812380
35,50 - 37,49	TTS18-S	40	412	336	300	70	TTS100-18-DR8-3550-40-HB	30809673

ciąg dalszy na następnej stronie.

Uchwyty wymiennej głowicy TTS 100 (8xD), wewnętrzne doprowadzenie chłodziwa

Wymiary							Typ chwytu HB	
d ₁	Złącze	d ₂ h6	l ₁	l ₂	l ₃	l ₄	Specyfikacja	Nr materiałowy
37,50 - 39,49	TTS18-S	32	421	353	316	60	TTS100-18-DR8-3750-32-HB	30812379
37,50 - 39,49	TTS18-S	40	431	353	316	70	TTS100-18-DR8-3750-40-HB	30809961
39,50 - 41,49	TTS18-S	32	440	374	332	70	TTS100-18-DR8-3950-32-HB	30812376
39,50 - 41,49	TTS18-S	40	450	374	332	70	TTS100-18-DR8-3950-40-HB	30809964
41,50 - 43,49	TTS18-S	40	470	394	348	70	TTS100-18-DR8-4150-40-HB	30809976
43,50 - 45,49	TTS18-S	40	500	422	364	70	TTS100-18-DR8-4350-40-HB	30809158

Możliwość konfiguracji parametrów



Typ chwytu:
Typ chwytu: HA | HE



Specyfikacja:
TTS100-18-DR8-4150-40-[typ chwytu]

Przykład:

TTS100-18-DR8-4150-40-HE

Typ chwytu HE

Uchwyt wymiennej głowicy TTS

Z systemem mocowania od przodu do wiertła z wymienną głowicą TTD
TTS100 (12xD), wewnętrzne doprowadzenie chłodziwa

Wersja:

Do średnicy wiertła: 12,00 - 32,49 mm
System wymiany płytki: System mocowania z przodu
Możliwość wymiany głowicy w maszynie

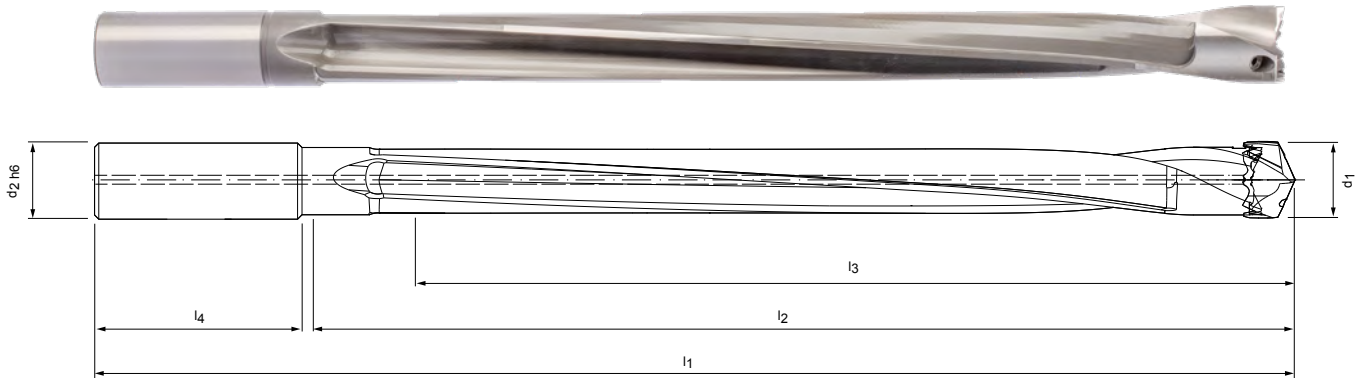

Magazynowa seria preferowana

Wymiary							Typ chwytu HB	
d ₁	Złącze	d ₂ h6	l ₁	l ₂	l ₃	l ₄	Specyfikacja	Nr materiałowy
12,00-12,49	TTS12-S	14	210	162	150	45	TTS100-12-DR12-1200-14-HB	30327798
12,50-12,99	TTS12-S	14	216	168	156	45	TTS100-12-DR12-1250-14-HB	30327802
13,00-13,49	TTS12-S	14	223	175	162	45	TTS100-12-DR12-1300-14-HB	30327805
13,50-13,99	TTS12-S	16	235	182	168	48	TTS100-12-DR12-1350-16-HB	30327808
14,00-14,49	TTS12-S	16	242	189	174	48	TTS100-12-DR12-1400-16-HB	30327811
14,50-14,99	TTS12-S	16	248	195	180	48	TTS100-12-DR12-1450-16-HB	30327814
15,00-15,49	TTS12-S	16	255	202	186	48	TTS100-12-DR12-1500-16-HB	30327817
15,50-16,49	TTS12-S	18	262	209	198	48	TTS100-12-DR12-1550-18-HB	30327820
16,50-17,49	TTS12-S	18	275	222	210	48	TTS100-12-DR12-1650-18-HB	30327824
17,50-18,49	TTS12-S	18	289	236	222	48	TTS100-12-DR12-1750-18-HB	30327828
18,50-19,49	TTS12-S	20	304	249	234	50	TTS100-12-DR12-1850-20-HB	30327833
19,50-20,49	TTS12-S	20	318	263	246	50	TTS100-12-DR12-1950-20-HB	30255588
20,50-21,49	TTS12-S	25	337	276	258	56	TTS100-12-DR12-2050-25-HB	30327844
21,50-22,49	TTS12-S	25	351	290	270	56	TTS100-12-DR12-2150-25-HB	30327847
22,50-23,49	TTS12-S	25	364	303	282	56	TTS100-12-DR12-2250-25-HB	30327851
23,50-24,49	TTS12-S	25	378	317	294	56	TTS100-12-DR12-2350-25-HB	30327854
24,50-25,49	TTS18-S	25	391	330	306	56	TTS100-18-DR12-2450-25-HB	30327859
25,50-26,49	TTS18-S	25	405	344	318	56	TTS100-18-DR12-2550-25-HB	30327863
26,50-27,49	TTS18-S	25	418	357	330	56	TTS100-18-DR12-2650-25-HB	30327866
27,50-28,49	TTS18-S	25	432	371	342	56	TTS100-18-DR12-2750-25-HB	30327870
28,50-29,49	TTS18-S	32	449	384	354	60	TTS100-18-DR12-2850-32-HB	30327873
29,50-30,49	TTS18-S	32	463	398	366	60	TTS100-18-DR12-2950-32-HB	30327876
30,50-31,49	TTS18-S	32	476	411	378	60	TTS100-18-DR12-3050-32-HB	30327879
31,50-32,49	TTS18-S	32	490	425	390	60	TTS100-18-DR12-3150-32-HB	30327883

Możliwość konfiguracji parametrów

Typ chwytu:
Typ chwytu: HA | HE

Specyfikacja:
TTS100-18-DR12-2850-32-[typ chwytu]

Przykład:

TTS100-18-DR12-2850-32-HE

Typ chwytu HE

Wymiary podano w mm.

Należy przestrzegać instrukcji obsługi wiertła z wymienną głowicą TTD (12xD) na stronie 748. Wersje specjalne na zapytanie.

Części zamienne

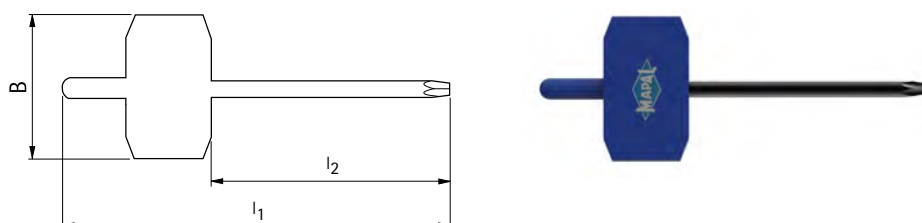

Wkrętaki sześciokątne

Typ uchwytu	sw	l_1	l_2	B	Nr materiałowy
TS100-12-DRx-1200-14-HB	1,3	95	60	38	10004355
TS100-12-DRx-1250-14-HB	1,3	95	60	38	10004355
TS100-12-DRx-1300-14-HB	1,3	95	60	38	10004355
TS100-12-DRx-1350-16-HB	1,5	95	60	38	10098108
TS100-12-DRx-1400-16-HB	1,5	95	60	38	10098108
TS100-12-DRx-1450-16-HB	1,5	95	60	38	10098108
TS100-12-DRx-1500-16-HB	1,5	95	60	38	10098108
TS100-12-DRx-1550-18-HB	1,5	95	60	38	10098108
TS100-12-DRx-1650-18-HB	2	95	60	38	10098109
TS100-12-DRx-1750-18-HB	2	95	60	38	10098109
TS100-12-DRx-1850-20-HB	2	95	60	38	10098109
TS100-12-DRx-1950-20-HB	2	95	60	38	10098109
TS100-12-DRx-2050-25-HB	2	95	60	38	10098109
TS100-12-DRx-2150-25-HB	2	95	60	38	10098109
TS100-12-DRx-2250-25-HB	2	95	60	38	10098109
TS100-12-DRx-2350-25-HB	2	95	60	38	10098109
TS100-18-DRx-2450-25-HB	2,5	95	60	38	10098110
TS100-18-DRx-2550-25-HB	2,5	95	60	38	10098110
TS100-18-DRx-2650-25-HB	2,5	95	60	38	10098110
TS100-18-DRx-2750-25-HB	2,5	95	60	38	10098110
TS100-18-DRx-2850-32-HB	2,5	95	60	38	10098110
TS100-18-DRx-2950-32-HB	2,5	95	60	38	10098110
TS100-18-DRx-3050-32-HB	2,5	95	60	38	10098110
TS100-18-DRx-3150-32-HB	2,5	95	60	38	10098110
TS100-18-DRx-3250-32-HB	3	100	60	38	10006234
TS100-18-DRx-3350-32-HB	3	100	60	38	10006234
TS100-18-DRx-3450-32-HB	3	100	60	38	10006234
TS100-18-DRx-3550-40-HB	3	100	60	38	10006234
TS100-18-DRx-3750-40-HB	3	100	60	38	10006234
TS100-18-DRx-3950-40-HB	3	100	60	38	10006234
TS100-18-DRx-4150-40-HB	4	100	60	38	10006235
TS100-18-DRx-4350-40-HB	4	100	60	38	10006235

Śruba gwintowana z powłoką specjalną

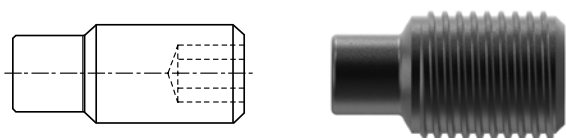

Typ uchwytu	Trzpień gwintowany	Moment dokręcania [Nm]	Nr materiałowy
TS100-12-DRx-1200-14-HB	M2,5x5	1,0	30259117
TS100-12-DRx-1250-14-HB	M2,5x6	1,0	30259118
TS100-12-DRx-1300-14-HB	M2,5x6	1,0	30259118
TS100-12-DRx-1350-16-HB	M3x6	1,3	30259119
TS100-12-DRx-1400-16-HB	M3x6	1,3	30259119
TS100-12-DRx-1450-16-HB	M3x7	1,3	30193231
TS100-12-DRx-1500-16-HB	M3x7	1,3	30193231
TS100-12-DRx-1550-18-HB	M3x7	1,3	30193231
TS100-12-DRx-1650-18-HB	M4x0,5x7,5	3,5	30193232
TS100-12-DRx-1750-18-HB	M4x0,5x7,5	3,5	30193232
TS100-12-DRx-1850-20-HB	M4x0,5x7,5	3,5	30193232
TS100-12-DRx-1950-20-HB	M4x0,5x7,5	3,5	30193232
TS100-12-DRx-2050-25-HB	M4x0,5x10	3,5	30193233
TS100-12-DRx-2150-25-HB	M4x0,5x10	3,5	30193233
TS100-12-DRx-2250-25-HB	M4x0,5x10	3,5	30193233
TS100-12-DRx-2350-25-HB	M4x0,5x10	3,5	30193233
TS100-18-DRx-2450-25-HB	M5x0,5x11	4,0	30193234
TS100-18-DRx-2550-25-HB	M5x0,5x11	4,0	30193234
TS100-18-DRx-2650-25-HB	M5x0,5x11	4,0	30193234
TS100-18-DRx-2750-25-HB	M5x0,5x11	4,0	30193234
TS100-18-DRx-2850-32-HB	M5x0,5x14	4,0	30193235
TS100-18-DRx-2950-32-HB	M5x0,5x14	4,0	30193235
TS100-18-DRx-3050-32-HB	M5x0,5x14	4,0	30193235
TS100-18-DRx-3150-32-HB	M5x0,5x14	4,0	30193235
TS100-18-DRx-3250-32-HB	M6x0,5x16	6,0	30320812
TS100-18-DRx-3350-32-HB	M6x0,5x16	6,0	30320812
TS100-18-DRx-3450-32-HB	M6x0,5x16	6,0	30320812
TS100-18-DRx-3550-40-HB	M6x0,5x18	6,0	30320811
TS100-18-DRx-3750-40-HB	M6x0,5x18	6,0	30320811
TS100-18-DRx-3950-40-HB	M6x0,5x20	6,0	30320810
TS100-18-DRx-4150-40-HB	M8x1x20	10,0	30320806
TS100-18-DRx-4350-40-HB	M8x1x20	10,0	30320806

Zalecane parametry skrawania dla wiertel z wymienną głowicą TTD

Posuw i prędkość skrawania

Typ 01 – Uni-Plus

MZG*	Materiał obrabiany		Wytrzymałość/twardość [N/mm ²] [HRC]	
P	P1	P1.1	Stale konstrukcyjne, użytkowe i uszlachetnione, stale niestopowe	< 700
		P1.2	Stale konstrukcyjne, użytkowe i uszlachetnione, stale niestopowe	< 1 200
	P2	P2.1	Stale azotowane, użytkowe i uszlachetnione, stale stopowe	< 900
		P2.2	Stale azotowane, użytkowe i uszlachetnione, stale stopowe	< 1 400
	P3	P3.1	Stale narzędziowe, łożyskowe, sprężynowe i stale szybkoobrotowe**	< 800
		P3.2	Stale narzędziowe, łożyskowe, sprężynowe i stale szybkoobrotowe**	< 1 000
		P3.3	Stale narzędziowe, łożyskowe, sprężynowe i stale szybkoobrotowe**	< 1 500
	P5	P5.1	Staliwo	
	K	K1	K1.1	Żeliwo z grafitem płatkowym (żeliwo szare), GJL
K2.1			Żeliwo sferoidalne, GJS	< 500
K2		K2.2	Żeliwo sferoidalne, GJS	≤ 800
		K2.3	Żeliwo sferoidalne, GJS	> 800
K3		K3.1	Żeliwo wermikularne, GJV, (żeliwo ciągliwe), GJL	< 500
		K3.2	Żeliwo wermikularne, GJV, (żeliwo ciągliwe), GJL	> 500

Typ 04 – Steel

MZG*	Materiał obrabiany		Wytrzymałość/twardość [N/mm ²] [HRC]	
P	P1	P1.1	Stale konstrukcyjne, użytkowe i uszlachetnione, stale niestopowe	< 700
		P1.2	Stale konstrukcyjne, użytkowe i uszlachetnione, stale niestopowe	< 1 200
	P2	P2.1	Stale azotowane, użytkowe i uszlachetnione, stale stopowe	< 900
		P2.2	Stale azotowane, użytkowe i uszlachetnione, stale stopowe	< 1 400
	P3	P3.1	Stale narzędziowe, łożyskowe, sprężynowe i stale szybkoobrotowe**	< 800
		P3.2	Stale narzędziowe, łożyskowe, sprężynowe i stale szybkoobrotowe**	< 1 000
		P3.3	Stale narzędziowe, łożyskowe, sprężynowe i stale szybkoobrotowe**	< 1 500
	P4	P4.1	Stale nierdzewne, ferrytyczne i martenzytyczne	
	P5	P5.1	Staliwo	
P6	P6.1	Staliwo nierdzewne, ferrytyczne i martenzytyczne		
K	K1	K1.1	Żeliwo z grafitem płatkowym (żeliwo szare), GJL	< 300
		K2.1	Żeliwo sferoidalne, GJS	< 500
	K2	K2.2	Żeliwo sferoidalne, GJS	≤ 800
		K2.3	Żeliwo sferoidalne, GJS	> 800
	K3	K3.1	Żeliwo wermikularne, GJV, (żeliwo ciągliwe), GJL	< 500
		K3.2	Żeliwo wermikularne, GJV, (żeliwo ciągliwe), GJL	> 500

Typ 03 – Alu

MZG*	Materiał obrabiany		Wytrzymałość/twardość [N/mm ²] [HRC]	
N	N1	N1.1	Aluminium, niestopowe i stopowe < 3 % Si	
		N1.2	Aluminium, stopowe ≤ 7 % Si	
		N1.3	Aluminium, stopowe > 7-12 % Si	
		N1.4	Aluminium, stopowe > 12 % Si	
	N2	N2.1	Miedź, niestopowa i niskostopowa	< 300
		N2.2	Miedź, stopowa	> 300
N2.3		Mosiądz, brąz, spiż	< 1 200	

* Grupa materiałowa wg MAPAL

** Jeśli składniki stopu Cr, Mo, Ni, V, W wynoszą łącznie > 8%, należy wybrać następną w kolejności grupę materiałową MAPAL.

	Prędkość skrawania v_c [m/min]				Posuw f [mm] przy średnicy wiertła					
	Chłodzenie wewnętrzne	Chłodzenie zewnętrzne	Mgiełka	Powietrze	12,00	15,50	19,50	25,00	32,00	40,00
	110	100	100		0,23	0,26	0,29	0,32	0,33	0,33
	100	85	85		0,29	0,33	0,37	0,40	0,41	0,41
	110	95	95		0,27	0,31	0,35	0,37	0,39	0,39
	75	65	65		0,22	0,25	0,27	0,30	0,31	0,31
	85	70	70		0,24	0,28	0,31	0,34	0,35	0,35
	65	60	60		0,20	0,23	0,25	0,27	0,28	0,29
	65	50	55		0,16	0,18	0,20	0,21	0,22	0,22
	110	95	95		0,27	0,31	0,35	0,37	0,39	0,39
	110	75	75	75	0,34	0,39	0,44	0,48	0,49	0,49
	145	90	110	110	0,31	0,36	0,40	0,44	0,45	0,46
	90	70	70		0,27	0,31	0,35	0,38	0,39	0,39
	55	35	45		0,18	0,21	0,23	0,25	0,26	0,26
	80	70	70		0,29	0,34	0,37	0,40	0,42	0,42
	70	65	65		0,23	0,27	0,30	0,32	0,33	0,33

	Prędkość skrawania v_c [m/min]				Posuw f [mm] przy średnicy wiertła					
	Chłodzenie wewnętrzne	Chłodzenie zewnętrzne	Mgiełka	Powietrze	12,00	15,50	19,50	25,00	32,00	40,00
	110	100	100		0,26	0,30	0,34	0,36	0,38	0,38
	100	85	85		0,33	0,38	0,42	0,46	0,47	0,47
	110	95	95		0,31	0,36	0,40	0,43	0,45	0,45
	75	65	65		0,25	0,28	0,31	0,34	0,35	0,35
	85	70	70		0,28	0,32	0,36	0,39	0,40	0,41
	65	60	60		0,23	0,26	0,29	0,32	0,33	0,33
	65	50	55		0,18	0,20	0,23	0,24	0,25	0,25
	65	50	55		0,18	0,21	0,24	0,25	0,26	0,27
	110	95	95		0,31	0,36	0,40	0,43	0,45	0,45
	65	50	55		0,18	0,21	0,24	0,25	0,26	0,27
	110	75	75	75	0,37	0,44	0,49	0,53	0,55	0,55
	145	90	110	110	0,35	0,40	0,45	0,49	0,50	0,51
	90	70	70		0,30	0,35	0,39	0,42	0,43	0,43
	55	35	45		0,20	0,23	0,25	0,27	0,28	0,29
	80	70	70		0,32	0,37	0,41	0,45	0,47	0,47
	70	65	65		0,26	0,30	0,33	0,35	0,37	0,37

	Prędkość skrawania v_c [m/min]				Posuw f [mm] przy średnicy wiertła					
	Chłodzenie wewnętrzne	Chłodzenie zewnętrzne	Mgiełka	Powietrze	12,00	15,50	19,50	25,00	32,00	40,00
	300	200	250		0,23	0,26	0,29	0,32	0,33	0,33
	250	180	200		0,30	0,35	0,39	0,42	0,43	0,43
	220	150	180		0,30	0,35	0,39	0,42	0,43	0,43
	180	120	150		0,30	0,35	0,39	0,42	0,43	0,43
	140	100			0,23	0,26	0,29	0,32	0,33	0,33
	120	90			0,30	0,35	0,39	0,42	0,43	0,43
	200	160	160	120	0,37	0,44	0,49	0,53	0,55	0,55

Podane parametry skrawania to wartości orientacyjne.

Optymalne wartości dla danego przypadku obróbki należy ustalić w ramach próby lub podczas obróbki.

Zalecane parametry skrawania dla wiertel z wymienną głowicą TTD

Posuw i prędkość skrawania

Typ O2 – Inox

MZG*	Materiał obrabiany	Wytrzymałość/twardość [N/mm ²] [HRC]	
P	P1.1 Stale konstrukcyjne, użytkowe i uszlachetnione, stale niestopowe	< 700	
	P1.2 Stale konstrukcyjne, użytkowe i uszlachetnione, stale niestopowe	< 1 200	
	P2.1 Stale azotowane, użytkowe i uszlachetnione, stale stopowe	< 900	
	P2.2 Stale azotowane, użytkowe i uszlachetnione, stale stopowe	< 1 400	
	P3.1 Stale narzędziowe, łożyskowe, sprężynowe i stale szybko tnące**	< 800	
	P3.2 Stale narzędziowe, łożyskowe, sprężynowe i stale szybko tnące**	< 1 000	
	P3.3 Stale narzędziowe, łożyskowe, sprężynowe i stale szybko tnące**	< 1 500	
	P4.1 Stale nierdzewne, ferrytyczne i martenzytyczne		
	P5.1 Staliwo		
	P6.1 Staliwo nierdzewne, ferrytyczne i martenzytyczne		
	M	M1.1 Stale nierdzewne, austenityczne	< 700
		M1.2 Stale nierdzewne, ferrytyczne/austenityczne (Duplex)	< 1 000
M2.1 Staliwo nierdzewne, austenityczne		< 700	
M3.1 Staliwo nierdzewne, ferrytyczne/austenityczne (Duplex)		< 1 000	
K	K1.1 Żeliwo z grafitem płatkowym (żeliwo szare), GJL	< 300	
	K2.1 Żeliwo sferoidalne, GJS	< 500	
	K2.2 Żeliwo sferoidalne, GJS	≤ 800	
	K2.3 Żeliwo sferoidalne, GJS	> 800	
	K3.1 Żeliwo wermikularne, GJV, (żeliwo ciągliwe), GJL	< 500	
	K3.2 Żeliwo wermikularne, GJV, (żeliwo ciągliwe), GJL	> 500	
N2	N2.1 Miedź, niestopowa i niskostopowa	< 300	
	N2.2 Miedź, stopowa	> 300	
	N2.3 Mosiądz, brąz, spiż	< 1 200	
S	S1.1 Tytan, stopy tytanu	< 400	
	S2.1 Tytan, stopy tytanu	< 1 200	
	S2.2 Tytan, stopy tytanu	> 1 200	
	S3.1 Nikiel, niestopowy i stopowy	< 900	
	S3.2 Nikiel, niestopowy i stopowy	> 900	
	S4.1 Nadstop o wysokiej odporności termicznej na bazie Ni, Co i Fe		
	S5.1 Stopy wolframu i molibdenu		

Typ O5 – Iron

MZG*	Materiał obrabiany	Wytrzymałość/twardość [N/mm ²] [HRC]
K	K1.1 Żeliwo z grafitem płatkowym (żeliwo szare), GJL	< 300
	K2.1 Żeliwo sferoidalne, GJS	< 500
	K2.2 Żeliwo sferoidalne, GJS	≤ 800
	K2.3 Żeliwo sferoidalne, GJS	> 800
	K3.1 Żeliwo wermikularne, GJV, (żeliwo ciągliwe), GJL	< 500
	K3.2 Żeliwo wermikularne, GJV, (żeliwo ciągliwe), GJL	> 500

* Grupa materiałowa wg MAPAL

** Jeśli składniki stopu Cr, Mo, Ni, V, W wynoszą łącznie > 8%, należy wybrać następną w kolejności grupę materiałową MAPAL.

	Prędkość skrawania v_c [m/min]				Posuw f [mm] przy średnicy wiertła					
	Chłodzenie wewnętrzne	Chłodzenie zewnętrzne	Mgietka	Powietrze	12,00	15,50	19,50	25,00	32,00	40,00
	100	90	90		0,21	0,24	0,26	0,28	0,30	0,30
	90	75	75		0,26	0,30	0,33	0,36	0,37	0,37
	100	85	85		0,24	0,28	0,31	0,34	0,35	0,35
	70	60	60		0,19	0,22	0,25	0,27	0,28	0,28
	75	65	65		0,22	0,25	0,28	0,30	0,32	0,32
	60	55	55		0,18	0,21	0,23	0,25	0,26	0,26
	60	45	50		0,14	0,16	0,18	0,19	0,20	0,20
	60	45	50		0,14	0,17	0,18	0,20	0,21	0,21
	100	85	85		0,24	0,28	0,31	0,34	0,35	0,35
	60	45	50		0,14	0,17	0,18	0,20	0,21	0,21
	55	35	35		0,18	0,21	0,24	0,25	0,26	0,27
	50	30	30		0,16	0,18	0,20	0,22	0,23	0,23
	55	35	35		0,18	0,21	0,24	0,25	0,26	0,27
	50	30	30		0,16	0,18	0,20	0,22	0,23	0,23
	95	70	70	70	0,34	0,39	0,44	0,48	0,49	0,49
	130	80	95	95	0,31	0,36	0,40	0,44	0,45	0,46
	80	60	60		0,27	0,31	0,35	0,38	0,39	0,39
	50	30	40		0,18	0,21	0,23	0,25	0,26	0,26
	70	65	65		0,29	0,34	0,37	0,40	0,42	0,42
	65	55	55		0,23	0,27	0,30	0,32	0,33	0,33
	140	100			0,23	0,26	0,29	0,32	0,33	0,33
	120	90			0,30	0,35	0,39	0,42	0,43	0,43
	200	160	160	120	0,37	0,44	0,49	0,53	0,55	0,55
	40	25			0,16	0,18	0,21	0,22	0,23	0,23
	30	20			0,14	0,16	0,18	0,19	0,20	0,20
	25	15			0,11	0,13	0,15	0,16	0,16	0,17
	20	15			0,09	0,11	0,12	0,13	0,13	0,13
	15	10			0,11	0,13	0,15	0,16	0,16	0,17
	15	10			0,09	0,11	0,12	0,13	0,13	0,13
	15	10			0,09	0,11	0,12	0,13	0,13	0,13

	Prędkość skrawania v_c [m/min]				Posuw f [mm] przy średnicy wiertła					
	Chłodzenie wewnętrzne	Chłodzenie zewnętrzne	Mgietka	Powietrze	12,00	15,50	19,50	25,00	32,00	40,00
	120	85	85	85	0,45	0,52	0,58	0,63	0,66	0,66
	160	100	120	120	0,42	0,48	0,54	0,58	0,60	0,61
	100	75	75		0,36	0,42	0,46	0,50	0,52	0,52
	60	40	50		0,24	0,28	0,30	0,33	0,34	0,34
	90	80	80		0,39	0,45	0,50	0,54	0,56	0,56
	80	70	70		0,31	0,36	0,39	0,43	0,44	0,44

Podane parametry skrawania to wartości orientacyjne.

Optymalne wartości dla danego przypadku obróbki należy ustalić w ramach próby lub podczas obróbki.

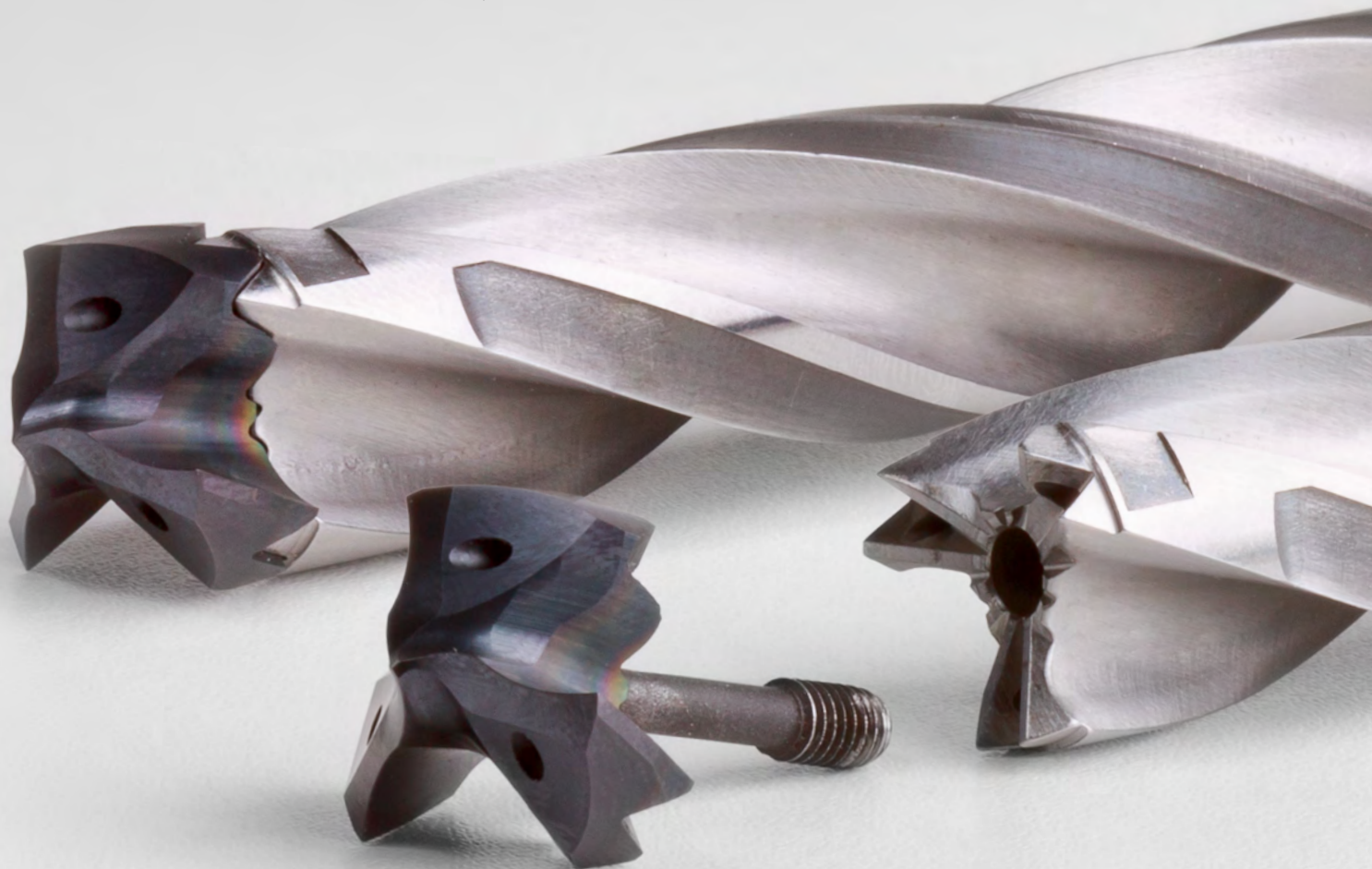

WIERTŁA Z WYMIENNĄ GŁOWICĄ TTD-TRITAN

Zminimalizowane zużycie węgla spiekanego przy zachowaniu najwyższej stabilności i precyzji

Trójstrzowe wiertło Tritan-Drill dostępne jest również w wariantcie z wymienną głowicą.

Głowica i uchwyt narzędzia są połączone ze sobą za pomocą uzębienia Hirtha. Złącze to jest szczególnie stabilne, dzięki czemu wariant z wymienną głowicą posiada wszystkie zalety, a także osiąga odpowiednika z węgla spiekanego. Stabilność złącza wynika m.in. z trójpodziału, który szczególnie dobrze sprawdza się we współpracy z systemem z wymienną głowicą.

Dzięki trzem ostrzom obciążenie złącza jest jednolite, tzn. siły powstające podczas obróbki są równomiernie przenoszone na stalowy uchwyt narzędzia. Ponadto złącze gwarantuje optymalne przenoszenie momentu obrotowego przy jednoczesnej wysokiej dokładności przezbrajania i niskiej wartości bicia.

W porównaniu z wiertłami dwustrzowymi z wymienną głowicą z węgla spiekanego wiertło TTD-Tritan pozwala uzyskać nawet dwukrotnie większe posuwy.

Dzięki temu możliwa jest niezawodna i stabilna praca nawet w trudnych warunkach, takich jak skośny wlot otworu czy wiercenie poprzeczne. Wydatnie zarysowana końcówka wierząca zapewnia optymalne centrowanie narzędzia i bardzo dobrą okrągłość. I to przy niższych kosztach niż wiertła z węgla spiekanego, ponieważ dzięki nowemu systemowi z wymienną głowicą zastosowanie drogiego węgla jest ograniczone do głowicy narzędzia. Gwarantuje to utrzymanie niższych kosztów nawet przy dużych średnicach.

Cechy charakterystyczne narzędzia

Chwyt cylindryczny z powierzchnią mocującą: zapewnia bezpieczne mocowanie i optymalne przenoszenie siły

Trzy rowki wiórowe dla optymalnego transportu wiórów

Trójstrzowe wiertło z wymienną głowicą

Wysokiej jakości, hartowany materiał uchwyty

Zakres programu: dostępne wszystkie wersje długości

Uzębienie Hirtha zapobiegające pomyleniu elementu

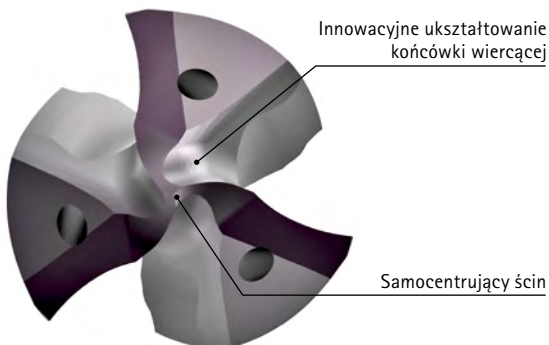

W SKRÓCIE

- Trójstrzowe wiertło z wymienną głowicą
- Zakres \varnothing 12,00 do 32,49 mm
- Głębokości wiercenia 3 | 5 i 8xD
- Z chłodzeniem wewnętrznym
- Prosta obsługa
- Możliwość wymiany głowicy w maszynie

WŁAŚCIWOŚCI UŻYTKOWE

- Nawet dwukrotnie większy posuw w porównaniu z dwustrzowymi wiertłami z wymienną głowicą
- Wysoka dokładność przezbrajania i niska wartość bicia
- Optymalne w przypadku skośnego wlotu otworu
- Centrowanie narzędzia dzięki wydatnie zarysowanej końcówce wierzącej
- Przeniesienie wysokiego momentu obrotowego

ZALETY

- Znaczne zwiększenie prędkości posuwu i trwałości narzędzia
- Geometria Tritan zapewniająca dobre wyniki wiercenia
- Wysoka stabilność procesu nawet w trudnych przypadkach
- Równomierne obciążenie złącza dzięki trzem ostrzom

Wymienna głowica TTD-Tritan

Z węgla spiekane, wewnętrzne doprowadzenie chłodziwa
Typ 01 – Uni

Wersja:

Średnica wiertła: 12,00 – 32,49 mm
Tolerancja otworu: IT 9 (osiągalne)
Materiał skrawający: HP926
Liczba ostrzy: 3
Liczba łysinek: 3
Kąt wierzchołkowy: 140°

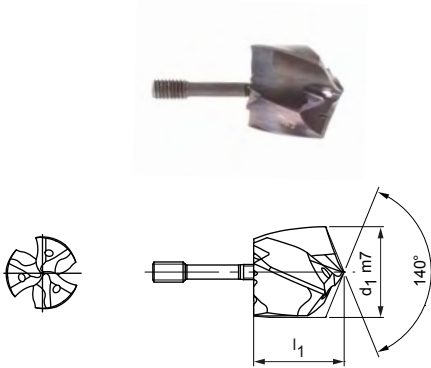

Magazynowa seria preferowana

d ₁ od 13,50 do 20,00		
d ₁ m7	Specyfikacja	Nr materiałowy
13,50	TTD300-3F01-1350-HP926	30871173
14,00	TTD300-3F01-1400-HP926	30871178
14,40	TTD300-3F01-1440-HP926	30871182
14,60	TTD300-3F01-1460-HP926	30871184
15,00	TTD300-3F01-1500-HP926	30871188
15,10	TTD300-3F01-1510-HP926	30871189
15,20	TTD300-3F01-1520-HP926	30871190
15,38	TTD300-3F01-1538-HP926	31290822
15,40	TTD300-3F01-1540-HP926	30871192
16,00	TTD300-3F01-1600-HP926	30871198
16,50	TTD300-3F01-1650-HP926	30871203
17,00	TTD300-3F01-1700-HP926	30871209
17,50	TTD300-3F01-1750-HP926	30871214
18,00	TTD300-3F01-1800-HP926	30871219
18,50	TTD300-3F01-1850-HP926	30871224
19,00	TTD300-3F01-1900-HP926	30871229
19,80	TTD300-3F01-1980-HP926	30871237
20,00	TTD300-3F01-2000-HP926	30871239

d ₁ od 20,50 do 32,00		
d ₁ m7	Specyfikacja	Nr materiałowy
20,50	TTD300-3F01-2050-HP926	30871244
21,00	TTD300-3F01-2100-HP926	30871249
22,00	TTD300-3F01-2200-HP926	30871259
24,00	TTD300-3F01-2400-HP926	30871279
24,70	TTD300-3F01-2470-HP926	30871287
25,00	TTD300-3F01-2500-HP926	30871290
25,10	TTD300-3F01-2510-HP926	30871291
25,20	TTD300-3F01-2520-HP926	30871292
26,00	TTD300-3F01-2600-HP926	30871300
26,10	TTD300-3F01-2610-HP926	30871301
26,50	TTD300-3F01-2650-HP926	30871305
27,00	TTD300-3F01-2700-HP926	30871310
27,10	TTD300-3F01-2710-HP926	30871311
28,00	TTD300-3F01-2800-HP926	30871320
28,50	TTD300-3F01-2850-HP926	30871325
31,00	TTD300-3F01-3100-HP926	30871350
32,00	TTD300-3F01-3200-HP926	30871360

Możliwość konfiguracji parametrów



Średnica:
możliwość wyboru średnicy w krokach
co 0,01 mm

Specyfikacja:
TTD300-3F01-[średnica]-HP929

Wymiary typoszeregu z możliwością konfiguracji parametrów

d ₁ min.	d ₁ maks.
12,00	32,49

Przykład:
TTD300-4F03-1401-HP619

Średnica narzędzia d₁ = 14,01 mm

Wymiary podano w mm.

Zalecane parametry skrawania - patrz koniec rozdziału.

Wersje specjalne i inne powłoki wg zapytania ofertowego.

Uchwyt wymiennej głowicy TTS

TTS300 z osiowym systemem mocowania do wiertel z wymienną głowicą TTD-Tritan (3xD), wewnętrzne doprowadzenie chłodziwa

Wersja:

Średnica wiertła: 12,00 – 32,49 mm
System wymiany płytki: Centralne mocowanie przez otwór doprowadzający chłodziwo

Uwaga:

Klucz montażowy w zakresie dostawy.

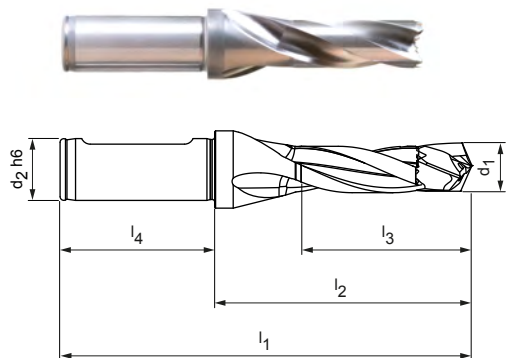

Magazynowa seria preferowana

Wymiary						Typ chwytu HB	
d ₁	d ₂ h6	l ₁	l ₂	l ₃	l ₄	Specyfikacja	Nr materiałowy
14,00 - 14,49	16	120	72	48	48	TTS300B-1400-DR3-ZYL-16-MN	30839684
14,50 - 14,99	16	122	74	49	48	TTS300B-1450-DR3-ZYL-16-MN	30839685
15,00 - 15,49	16	124	76	51	48	TTS300B-1500-DR3-ZYL-16-MN	30839686
17,50 - 18,49	20	140	90	61	50	TTS300B-1750-DR3-ZYL-20-MN	30839689
18,50 - 19,49	25	150	94	64	56	TTS300B-1850-DR3-ZYL-25-MN	30839690
20,50 - 21,49	25	159	103	71	56	TTS300B-2050-DR3-ZYL-25-MN	30839692
21,50 - 22,49	25	164	108	74	56	TTS300B-2150-DR3-ZYL-25-MN	30839693
24,50 - 25,49	32	182	122	84	60	TTS300B-2450-DR3-ZYL-32-MN	30839696
26,50 - 27,49	32	191	131	91	60	TTS300B-2650-DR3-ZYL-32-MN	30839698

Dostępne na zapytanie

Wymiary						Typ chwytu HB	
d ₁	d ₂ h6	l ₁	l ₂	l ₃	l ₄	Specyfikacja	Nr materiałowy
12,00 - 12,49	16	111	63	39	48	TTS300B-1200-DR3-ZYL-16-MN	30839680
12,50 - 12,99	16	113	65	43	48	TTS300B-1250-DR3-ZYL-16-MN	30839681
13,00 - 13,49	16	115	67	45	48	TTS300B-1300-DR3-ZYL-16-MN	30839682
13,50 - 13,99	16	117	69	46	48	TTS300B-1350-DR3-ZYL-16-MN	30839683
15,50 - 16,49	20	131	81	54	50	TTS300B-1550-DR3-ZYL-20-MN	30839687
16,50 - 17,49	20	135	85	58	50	TTS300B-1650-DR3-ZYL-20-MN	30839688
19,50 - 20,49	25	155	99	68	56	TTS300B-1950-DR3-ZYL-25-MN	30839691
22,50 - 23,49	25	168	112	78	56	TTS300B-2250-DR3-ZYL-25-MN	30839694
23,50 - 24,49	25	173	117	81	56	TTS300B-2350-DR3-ZYL-25-MN	30839695
25,50 - 26,49	32	186	126	87	60	TTS300B-2550-DR3-ZYL-32-MN	30839697
27,50 - 28,49	32	195	135	94	60	TTS300B-2750-DR3-ZYL-32-MN	30839699
28,50 - 29,49	32	200	140	97	60	TTS300B-2850-DR3-ZYL-32-MN	30839700
29,50 - 30,49	32	204	144	101	60	TTS300B-2950-DR3-ZYL-32-MN	30839701
30,50 - 31,49	32	209	149	104	60	TTS300B-3050-DR3-ZYL-32-MN	30839702
31,50 - 32,49	32	213	153	107	60	TTS300B-3150-DR3-ZYL-32-MN	30839703

Wymiary podano w mm.

Wersje specjalne na zapytanie.

Uchwyt wymiennej głowicy TTS

TTS300 z osiowym systemem mocowania do wiertel z wymienną głowicą TTD-Tritan (5xD), wewnętrzne doprowadzenie chłodziwa

Wersja:

Średnica wiertła: 12,00 – 32,49 mm
System wymiany płytki: Centralne mocowanie przez otwór doprowadzający chłodziwo

Uwaga:

Klucz montażowy w zakresie dostawy.

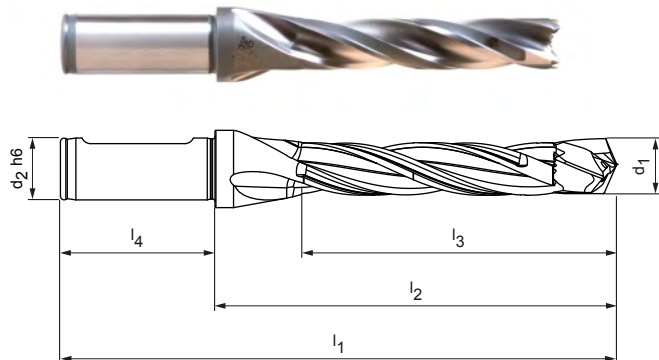

Magazynowa seria preferowana

Wymiary						Typ chwytu HB	
d ₁	d ₂ h6	l ₁	l ₂	l ₃	l ₄	Specyfikacja	Nr materiałowy
14,00 - 14,49	16	149	101	77	48	TTS300B-1400-DR5-ZYL-16-MN	30839708
15,00 - 15,49	16	155	107	82	48	TTS300B-1500-DR5-ZYL-16-MN	30839710
16,50 - 17,49	20	170	120	93	50	TTS300B-1650-DR5-ZYL-20-MN	30839712
17,50 - 18,49	20	177	127	98	50	TTS300B-1750-DR5-ZYL-20-MN	30839713
23,50 - 24,49	25	222	166	130	56	TTS300B-2350-DR5-ZYL-25-MN	30839719
24,50 - 25,49	32	233	173	135	60	TTS300B-2450-DR5-ZYL-32-MN	30839720
26,50 - 27,49	32	246	186	146	60	TTS300B-2650-DR5-ZYL-32-MN	30839722

Dostępne na zapytanie

Wymiary						Typ chwytu HB	
d ₁	d ₂ h6	l ₁	l ₂	l ₃	l ₄	Specyfikacja	Nr materiałowy
12,00 - 12,49	16	136	88	66	48	TTS300B-1200-DR5-ZYL-16-MN	30839704
12,50 - 12,99	16	139	91	69	48	TTS300B-1250-DR5-ZYL-16-MN	30839705
13,00 - 13,49	16	142	94	71	48	TTS300B-1300-DR5-ZYL-16-MN	30839706
13,50 - 13,99	16	145	97	74	48	TTS300B-1350-DR5-ZYL-16-MN	30839707
14,50 - 14,99	16	152	104	79	48	TTS300B-1450-DR5-ZYL-16-MN	30839709
15,50 - 16,49	20	164	114	87	50	TTS300B-1550-DR5-ZYL-20-MN	30839711
18,50 - 19,49	25	189	133	103	56	TTS300B-1850-DR5-ZYL-25-MN	30839714
19,50 - 20,49	25	196	140	109	56	TTS300B-1950-DR5-ZYL-25-MN	30839715
20,50 - 21,49	25	202	146	114	56	TTS300B-2050-DR5-ZYL-25-MN	30839716
21,50 - 22,49	25	209	153	119	56	TTS300B-2150-DR5-ZYL-25-MN	30839717
22,50 - 23,49	25	215	159	124	56	TTS300B-2250-DR5-ZYL-25-MN	30839718
25,50 - 26,49	32	239	179	140	60	TTS300B-2550-DR5-ZYL-32-MN	30839721
27,50 - 28,49	32	252	192	151	60	TTS300B-2750-DR5-ZYL-32-MN	30839723
28,50 - 29,49	32	259	199	156	60	TTS300B-2850-DR5-ZYL-32-MN	30839724
29,50 - 30,49	32	265	205	162	60	TTS300B-2950-DR5-ZYL-32-MN	30839725
30,50 - 31,49	32	272	212	167	60	TTS300B-3050-DR5-ZYL-32-MN	30839726
31,50 - 32,49	32	278	218	172	60	TTS300B-3150-DR5-ZYL-32-MN	30839727

Wymiary podano w mm.

Wersje specjalne na zapytanie.

Uchwyt wymiennej głowicy TTS

TTS300 z osiowym systemem mocowania do wiertel z wymienną głowicą TTD-Tritan (8xD), wewnętrzne doprowadzenie chłodziwa

Wersja:

Średnica wiertła: 12,00 – 32,49 mm
System wymiany płytki: Centralne mocowanie przez otwór doprowadzający chłodziwo

Uwaga:

Klucz montażowy w zakresie dostawy.

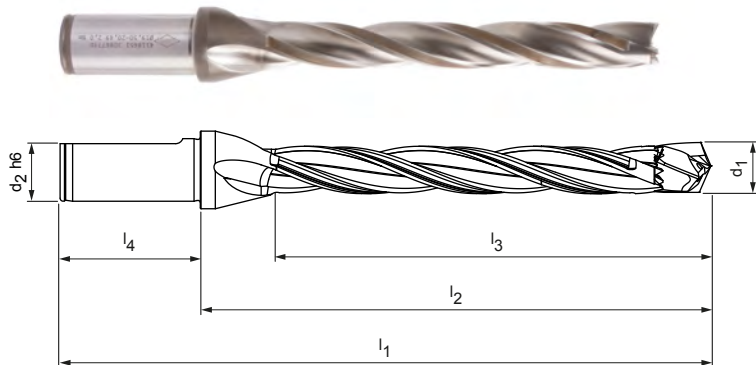

Magazynowa seria preferowana

Wymiary						Typ chwytu HB	
d ₁	d ₂ h6	l ₁	l ₂	l ₃	l ₄	Specyfikacja	Nr materiałowy
15,50 - 16,49	20	213	163	137	50	TTS300B-1550-DR8-ZYL-20-MN	30867702
20,50 - 21,49	25	267	211	178	56	TTS300B-2050-DR8-ZYL-25-MN	30867707

Dostępne na zapytanie

Wymiary						Typ chwytu HB	
d ₁	d ₂ h6	l ₁	l ₂	l ₃	l ₄	Specyfikacja	Nr materiałowy
12,00 - 12,49	16	173	125	104	48	TTS300B-1200-DR8-ZYL-16-MN	30867695
12,50 - 12,99	16	178	130	108	48	TTS300B-1250-DR8-ZYL-16-MN	30867696
13,00 - 13,49	16	183	135	112	48	TTS300B-1300-DR8-ZYL-16-MN	30867697
13,50 - 13,99	16	187	139	116	48	TTS300B-1350-DR8-ZYL-16-MN	30867698
14,00 - 14,49	16	192	144	120	48	TTS300B-1400-DR8-ZYL-16-MN	30867699
14,50 - 14,99	16	197	149	124	48	TTS300B-1450-DR8-ZYL-16-MN	30867700
15,00 - 15,49	16	202	154	129	48	TTS300B-1500-DR8-ZYL-16-MN	30867701
16,50 - 17,49	20	223	173	145	50	TTS300B-1650-DR8-ZYL-20-MN	30867703
17,50 - 18,49	20	232	182	153	50	TTS300B-1750-DR8-ZYL-20-MN	30867704
18,50 - 19,49	25	248	192	162	56	TTS300B-1850-DR8-ZYL-25-MN	30867705
19,50 - 20,49	25	257	201	170	56	TTS300B-1950-DR8-ZYL-25-MN	30867706
21,50 - 22,49	25	276	220	187	56	TTS300B-2150-DR8-ZYL-25-MN	30867708
22,50 - 23,49	25	286	230	195	56	TTS300B-2250-DR8-ZYL-25-MN	30867709
23,50 - 24,49	25	295	239	203	56	TTS300B-2350-DR8-ZYL-25-MN	30867710
24,50 - 25,49	32	309	249	212	60	TTS300B-2450-DR8-ZYL-32-MN	30867711
25,50 - 26,49	32	319	259	220	60	TTS300B-2550-DR8-ZYL-32-MN	30885879
26,50 - 27,49	32	328	268	228	60	TTS300B-2650-DR8-ZYL-32-MN	30867713
27,50 - 28,49	32	338	278	236	60	TTS300B-2750-DR8-ZYL-32-MN	30867714
28,50 - 29,49	32	342	282	245	60	TTS300B-2850-DR8-ZYL-32-MN	30867715
29,50 - 30,49	32	352	292	253	60	TTS300B-2950-DR8-ZYL-32-MN	30867716
30,50 - 31,49	32	361	301	261	60	TTS300B-3050-DR8-ZYL-32-MN	30867717
31,50 - 32,49	32	371	311	270	60	TTS300B-3150-DR8-ZYL-32-MN	30867718

Wymiary podano w mm.

Wersje specjalne na zapytanie.

Osprzęt i części zamienne do wiertel TTD-Tritan



Klucze TORX®

Zakres średnicy Wymienna głowica TTD-Tritan	TORX®	Moment dokręcania specjalna śruba mocująca [Nm]	Nr materiałowy
			do uchwytów o długości 3xD, 5xD i 8xD
12,00 - 12,49	6	0,4	30890316
12,50 - 12,99			
13,00 - 13,49			
13,50 - 13,99			
14,00 - 14,49			
14,50 - 14,99	7	0,7	30890318
15,00 - 15,49			
15,50 - 16,49			
16,50 - 17,49			
17,50 - 18,49			
18,50 - 19,49	8	1,3	30890321
19,50 - 20,49			
20,50 - 21,49			
21,50 - 22,49			
22,50 - 23,49			
23,50 - 24,49	10	2	30890323
24,50 - 25,49			
25,50 - 26,49			
26,50 - 27,49			
27,50 - 28,49			
28,50 - 29,49			
29,50 - 30,49			
30,50 - 31,49			
31,50 - 32,49			
	5,6		

Klucze dynamometryczne

Osprzęt	Zakres momentu dokręcania [Nm]	Nr materiałowy
Klucz dynamometryczny 	0,2 – 1,2	30911425
Klucz dynamometryczny 	1,0 – 6,0	30911426

Rękojeść klucza TORX®

Część zamienna	Chwył wtykowy	Nr materiałowy
Uchwyt Multi 	Gniazdo sześciokątne 1/4"	30918896

Zalecane parametry skrawania dla wiertel z wymienną głowicą TTD-Tritan

Posuw i prędkość skrawania

Typ 01 – Uni

MZG*		Materiał obrabiany	Wytrzymałość/twardość [N/mm ²] [HRC]	
P	P1	P1.1	Stale konstrukcyjne, użytkowe i uszlachetnione, stale niestopowe	< 700
		P1.2	Stale konstrukcyjne, użytkowe i uszlachetnione, stale niestopowe	< 1 200
	P2	P2.1	Stale azotowane, użytkowe i uszlachetnione, stale stopowe	< 900
		P2.2	Stale azotowane, użytkowe i uszlachetnione, stale stopowe	< 1 400
	P3	P3.1	Stale narzędziowe, łożyskowe, sprężynowe i stale szybko tnące**	< 800
		P3.2	Stale narzędziowe, łożyskowe, sprężynowe i stale szybko tnące**	< 1 000
		P3.3	Stale narzędziowe, łożyskowe, sprężynowe i stale szybko tnące**	< 1 500
	P5	P5.1	Staliwo	
K	K1	K1.1	Żeliwo z grafitem płatkowym (żeliwo szare), GJL	< 300
		K2.1	Żeliwo sferoidalne, GJS	< 500
	K2	K2.2	Żeliwo sferoidalne, GJS	≤ 800
		K2.3	Żeliwo sferoidalne, GJS	> 800
	K3	K3.1	Żeliwo wermikularne, GJV, (żeliwo ciągliwe), GJL	< 500
		K3.2	Żeliwo wermikularne, GJV, (żeliwo ciągliwe), GJL	> 500

* Grupa materiałowa wg MAPAL

** Jeśli składniki stopu Cr, Mo, Ni, V, W wynoszą łącznie > 8%, należy wybrać następną w kolejności grupę materiałową MAPAL.

	Prędkość skrawania v_c [m/min]				Posuw f [mm] przy średnicy wiertła					
	Chłodzenie wewnętrzne	Chłodzenie zewnętrzne	Mgietka	Powietrze	12,00	14,50	17,50	21,50	26,00	32,00
	90	80	80		0,38	0,42	0,46	0,50	0,53	0,54
	80	70	70		0,47	0,53	0,58	0,63	0,66	0,68
	90	75	75		0,45	0,50	0,55	0,59	0,62	0,64
	65	55	55		0,36	0,40	0,43	0,47	0,49	0,51
	70	60	60		0,40	0,45	0,49	0,53	0,56	0,58
	55	50	50		0,33	0,37	0,40	0,43	0,46	0,47
	55	40	45		0,26	0,28	0,31	0,33	0,35	0,36
	90	75	75		0,45	0,50	0,55	0,59	0,62	0,64
	110	75	75	75	0,62	0,69	0,77	0,83	0,88	0,90
	145	90	110	110	0,57	0,64	0,71	0,77	0,81	0,83
	90	70	70		0,49	0,55	0,61	0,66	0,69	0,71
	55	35	45		0,33	0,37	0,40	0,43	0,46	0,47
	80	70	70		0,53	0,59	0,65	0,71	0,75	0,77
	70	65	65		0,43	0,47	0,52	0,56	0,59	0,61

Podane parametry skrawania to wartości orientacyjne.

Optymalne wartości dla danego przypadku obróbki należy ustalić w ramach próby lub podczas obróbki.

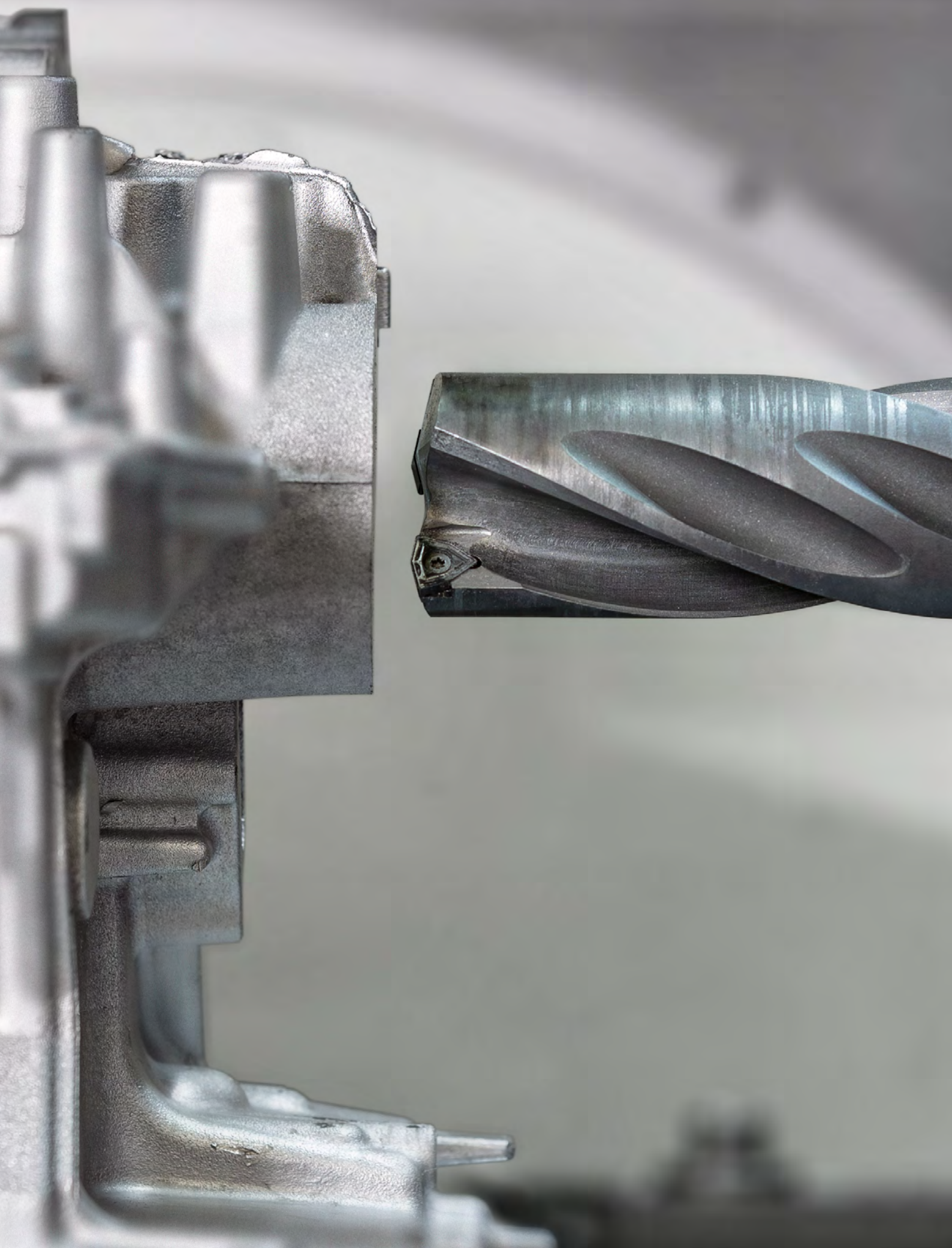

WIERCENIE W PEŁNYM MATERIALE NARZĘDZIAMI Z PŁYTKAMI SKRAWAJĄCYMI

Wiercenie w pełnym materiale narzędziami z płytkami skrawającymi

Wiertło z płytkami skrawającymi 240

Płytki skrawająca promieniowa WOGT, trójstrzowa 241

Aneks techniczny

Zalecane parametry skrawania dla wiertel z płytkami skrawającymi — 242

Informacje dotyczące zastosowania 744

WIERCENIE W PEŁNYM MATERIALE NARZĘDZIAMI Z PŁYTKAMI SKRAWAJĄCYMI

Płytki skrawające do wiercenia w pełnym aluminium przekonują trzema użytkowymi krawędziami skrawającymi i wysokowydajną powłoką diamentową CVD. Ostrza dostępne są w pięciu wielkościach. Dzięki temu mogą być wykorzystywane w bardzo szerokim zakresie zastosowań.

Jedno- lub wielostopniowe narzędzia specjalne charakteryzują się wyjątkowo wysoką ekonomicznością i prostą obsługą.



Przykład zastosowania

Materiał: AlSi1 v_c : 800 - 1000 m/min
 Średnica: 39,0 mm f : 0,30 - 0,45 mm
 Głębokość wiercenia: 65 mm

Trwałość krawędzi skrawających

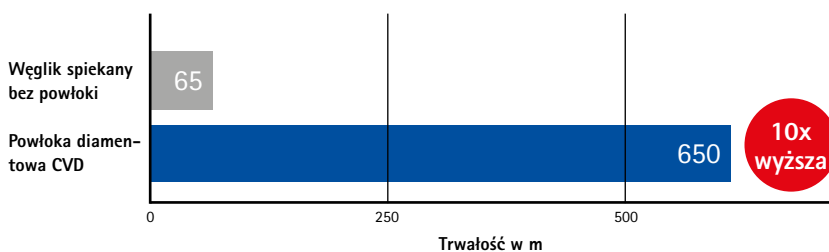

W SKRÓCIE

- Indywidualne rozwiązania dla: \varnothing 16-54,9 mm
- Wiercenie w pełnym materiale w AlSi1 do AlSi12
- Z chłodzeniem wewnętrznym, możliwa również mgielka
- Jedno- lub wielostopniowe z płytkami skrawającymi lub stopniem rozwiercania PCD

ZALETY

- Wyjątkowo ekonomiczne przy maksymalnej wydajności
- Szeroki zakres zastosowań
- Prosta obsługa



Pięć rozmiarów płytek skrawających dla zakresu średnicy od 16 do 54,9 mm.

WOGT

Płytki skrawająca promieniowa, trójstrzowa

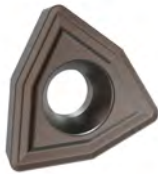

	Węglik spiekany	
Materiał obrabiany	N	
	Al stop. ← odporny na ścieranie	Cu stop. → ciągliwy
Rodzaj materiału skrawającego	HC698	
Wersja ostrza	X40	

Zakres ϕ [mm]

WOGT030206N-...-...	16,0 - 20,9	31033174
WOGT040206N-...-...	21,0 - 25,9	31033175
WOGT053006N-...-...	26,0 - 30,9	31033177
WOGT063008N-...-...	31,0 - 44,9	30787196
WOGT073808N-...-...	45,0 - 54,9	31033178

Oznaczenia – strona 676.

Przegląd materiałów skrawających – patrz strona 672.

Osprzęt do narzędzi z płytkami skrawającymi promieniowymi

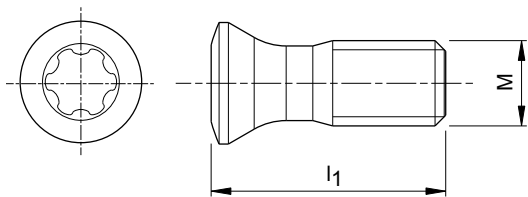

WSP	Wielkość WSP	Śruba mocująca					Wkrętak
		Wymiar [MxI]	Opis	Moment dokręcenia [Nm]	Wielkość TORX®	Nr materiałowy	Nr materiałowy
WOGT... 	0302	M2x4.95	MN659 M2x4.95-TX6-IP	0,4	TX6-IP	10002712	30414758
	0402	M2.2x6	MN659 M2.2x6-TX7-IP	0,9	TX7-IP	31074485	30414759
	0530	M3x8.5	MN659 M3x8.5-TX8-IP	1,5	TX8-IP	31074486	30414760
	0630	M3.5x9	MN659 M3.5x9-TX15-IP	2,8	TX15-IP	10105078	30414764
	0738	M4x9.4	MN659 M4x9.4-TX15-IP	3,5	TX15-IP	30480629	30414764

Zalecane parametry skrawania dla wiertel z płytkami skrawającymi

Posuw i prędkość skrawania

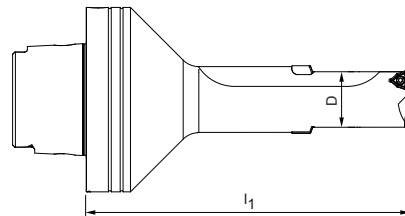

Wiertła z płytkami skrawającymi

Wartości wyjściowe prędkości skrawania i posuwu przy użyciu wiertel WOGT...-X40-HC698

MZG*	Materiał obrabiany	Wytrzymałość/twardość [N/mm ²] [HRC]
N1	N1.1 Aluminium, niestopowe i stopowe < 3 % Si	
	N1.2 Aluminium, stopowe ≤ 7 % Si	
	N1.3 Aluminium, stopowe > 7-12 % Si	
	N1.4 Aluminium, stopowe > 12 % Si	
N2	N2.1 Miedź, niestopowa i niskostopowa	< 300
	N2.2 Miedź, stopowa	> 300
	N2.3 Mosiądz, brąz, spiż	< 1 200
N3	N3.1 Grafit	
N4	N4.1 Tworzywo sztuczne, materiały termoplastyczne	
	N4.2 Tworzywo sztuczne, duroplast	
	N4.3 Tworzywo sztuczne, pianki	

Współczynniki korekcji:

Nawieranie/wycofanie wiertła

l_1	v_c	f_z
3xD	0,8	0,7
4xD	0,7	0,6
5xD	0,6	0,5

	Prędkość skrawania v_c [m/min]	Posuw f [mm] przy zakresie średnicy wiertła [mm]				
		16,00 - 20,90	21,00 - 25,90	26,00 - 30,90	31,00 - 44,90	45,00 - 54,90
	300 - 1 000	0,08 - 0,20	0,12 - 0,22	0,14 - 0,30	0,16 - 0,40	0,20 - 0,45
	230 - 900	0,06 - 0,18	0,10 - 0,20	0,12 - 0,25	0,14 - 0,30	0,18 - 0,35
	220 - 800	0,05 - 0,15	0,08 - 0,18	0,10 - 0,20	0,12 - 0,25	0,15 - 0,30
	200 - 700	0,05 - 0,15	0,08 - 0,18	0,10 - 0,20	0,12 - 0,25	0,15 - 0,30

Podane parametry skrawania to wartości orientacyjne.

Optymalne wartości dla danego przypadku obróbki należy ustalić w ramach próby lub podczas obróbki.



NAWIERCANIE

Nawiertak

Tritan-Spot-Drill-Steel	246
ECU-Centre-Drill	248
CPD-Spot-Drill	249
Uchwyt wymiennej głowicy CFS	250

Aneks techniczny

Zalecane parametry skrawania	251
------------------------------------	-----

Tritan-Spot-Drill-Steel

Nawiertak NC z węgla spiekane
SCD670, zewnętrzne doprowadzenie chłodziwa

Wersja:

Średnica wiertła: 4,00 – 20,00 mm
Typ chwytu: HA (DIN 6535)
Materiał skrawający: HP358
Liczba ostrzy: 3
Kąt wierzchołkowy: 155°

Zastosowanie:

Nawiertak NC dostosowany do Tritan-Drill-Steel.

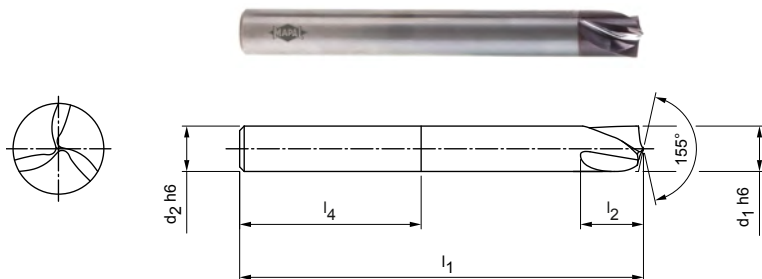

Magazynowa seria preferowana

Wymiary					Typ chwytu HA	
d ₁ h6	d ₂ h6	l ₁	l ₂	l ₄	Specyfikacja	Nr materiałowy
4,00	4	55	6	28	SCD670-0400-3-0-155HA-HP358	30980587
5,00	6	62	7	36	SCD670-0500-3-0-155HA-HP358	30980588
6,00	6	66	9	36	SCD670-0600-3-0-155HA-HP358	30980589
8,00	8	79	11	36	SCD670-0800-3-0-155HA-HP358	30980590
10,00	10	89	14	40	SCD670-1000-3-0-155HA-HP358	30980592
12,00	12	102	17	45	SCD670-1200-3-0-155HA-HP358	30980594
16,00	16	115	23	48	SCD670-1600-3-0-155HA-HP358	30980595
20,00	20	131	28	50	SCD670-2000-3-0-155HA-HP358	30980596

Głębokości nawiercania

d ₁ h6	d ₂ h6	l ₁	l ₂	l ₄	Maksymalna głębokość nawiercania *	Minimalna głębokość nawiercania **
4,00	4	55	6	28	0,40	0,24
5,00	6	62	7	36	0,50	0,30
6,00	6	66	9	36	0,60	0,36
8,00	8	79	11	36	0,80	0,48
10,00	10	89	14	40	1,00	0,60
12,00	12	102	17	45	1,20	0,72
16,00	16	115	23	48	1,60	0,96
20,00	20	131	28	50	2,00	1,20

* 10% Ø znamionowej

** 6% Ø znamionowej

Wymiary podano w mm.

Zalecane parametry skrawania - patrz koniec rozdziału.

Wersje specjalne i inne powłoki wg zapytania ofertowego.

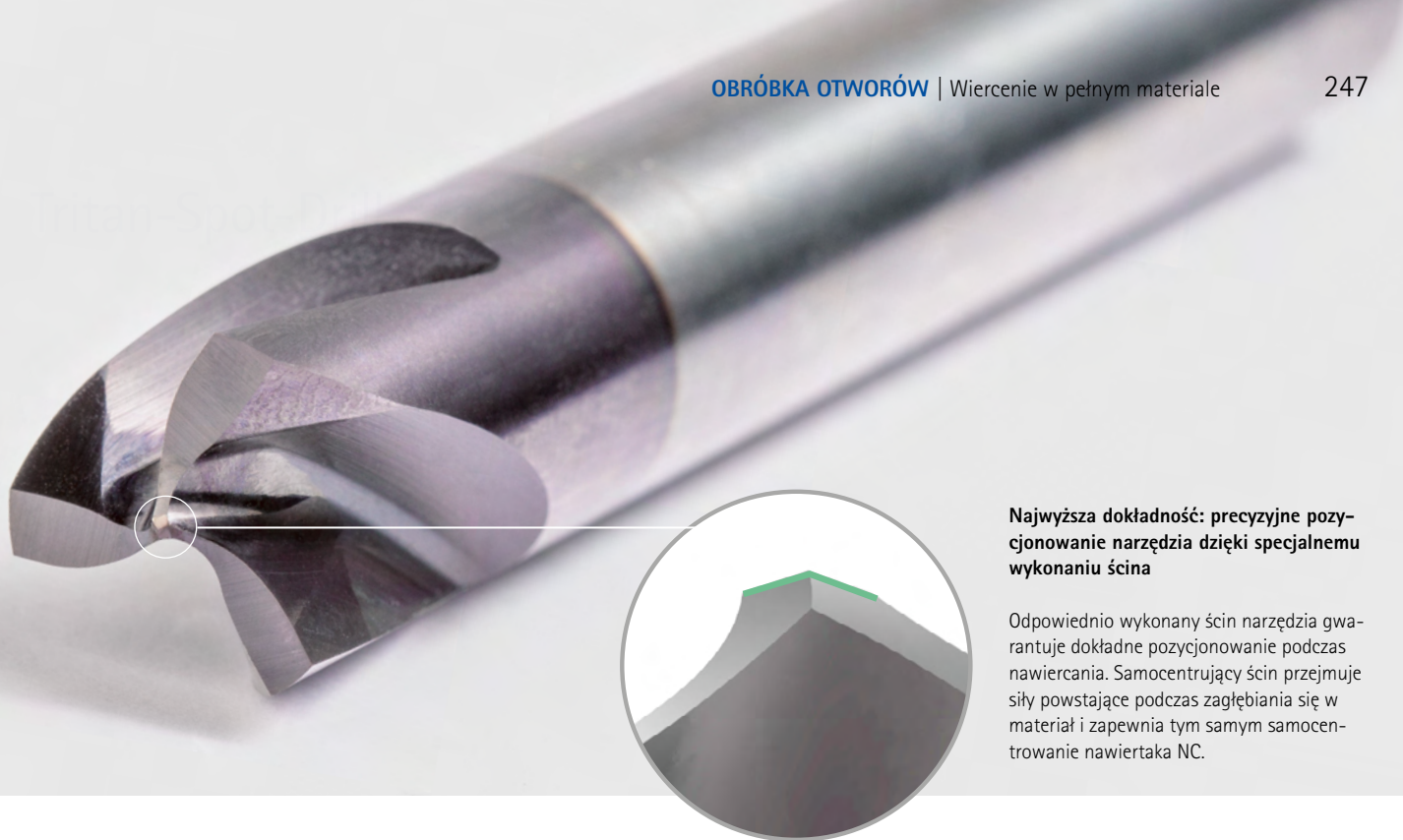

Najwyższa dokładność: precyzyjne pozycjonowanie narzędzia dzięki specjalnemu wykonaniu ścina

Odpowiednio wykonany ścin narzędzia gwarantuje dokładne pozycjonowanie podczas nawiercania. Samocentryujący ścin przejmuje siły powstające podczas zagłębiania się w materiał i zapewnia tym samym samocentryrowanie nawiertaka NC.

Tritan-Drill-Steel



Kąty wierzchołkowe wiertła Tritan-Spot-Drill-Steel (155°) i Tritan-Drill-Steel (140°/145°) są idealnie dopasowane do siebie.

Dostępne wersje wiertła Tritan-Drill-Steel:



SCD661 | 3xD



SCD661 | 5xD



SCD661 | 8xD



SCD661 | 12xD

Strategia wiercenia 3xD do 12xD:

Maksymalna głębokość nawiercania:

10%
(podana średnica
znamionowa w %)

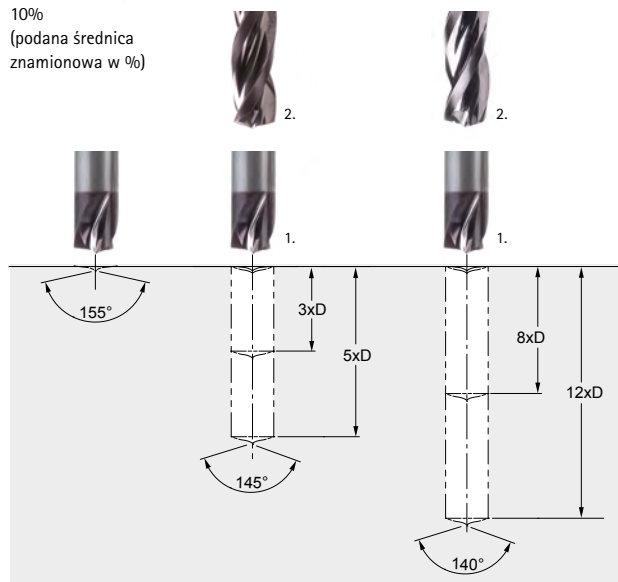

W SKRÓCIE

- Trójstrzowy nawiertak NC z kątem wierzchołkowym 155°
- Idealnie dopasowany do wiertła Tritan-Drill-Steel
- Wysoka dokładność pozycji narzędzia
- Samocentryujący ścin
- Odpowiednie nawet do trudnych przypadków wiercenia

ECU-Centre-Drill

Nawiertak z węgla spekanego
SCD450

Wersja:

Średnica wiertła: 0,50 – 2,50 mm

Materiał skrawający: HU318

Liczba ostrzy: 2

Liczba łysinek: 2

Kąt wierzchołkowy: 120°/60°

Kąt spirali: 5°

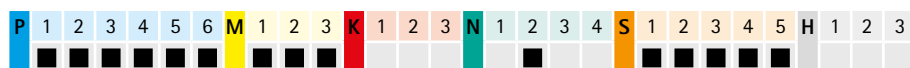
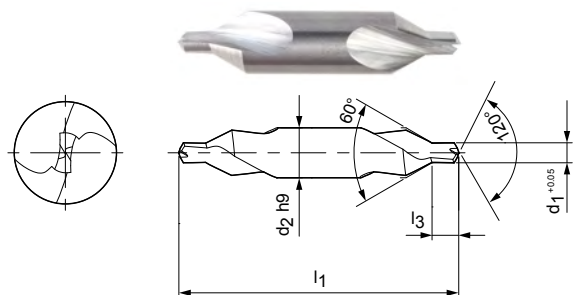

Magazynowa seria preferowana

Wymiary				Specyfikacja	Nr materiałowy
d_1 (0 +0,05)	d_2 h9	l_1	l_3		
0,50*	3,15	20	0,8	SCD450-0050-2-2-120HA-HU318	30561506
0,80*	3,15	20	1,1	SCD450-0080-2-2-120HA-HU318	30561507
1,00	3,15	31,5	1,3	SCD450-0100-2-2-120HA-HU318	30561508
1,25	3,15	31,5	1,6	SCD450-0125-2-2-120HA-HU318	30561509
1,60	4	35,5	2	SCD450-0160-2-2-120HA-HU318	30561510
2,00	5	40	2,5	SCD450-0200-2-2-120HA-HU318	30561511
2,50	6,3	45	3,1	SCD450-0250-2-2-120HA-HU318	30561512

Wymiary podano w mm.

*Skrawanie jednostronne.

Zalecane parametry skrawania – patrz koniec rozdziału.

Wersje specjalne i inne powłoki wg zapytania ofertowego.

CPD-Spot-Drill

Wykonanie ze złączem CFS
CPD100

Wersja:
Średnica wiertła: 8,00 - 20,00 mm
Materiał skrawający: HP338
Liczba ostrzy: 2
Kąt spirali: 15°
Kąt wierzchołkowy: 90°

Zastosowanie:
Wiercenie centryczne.

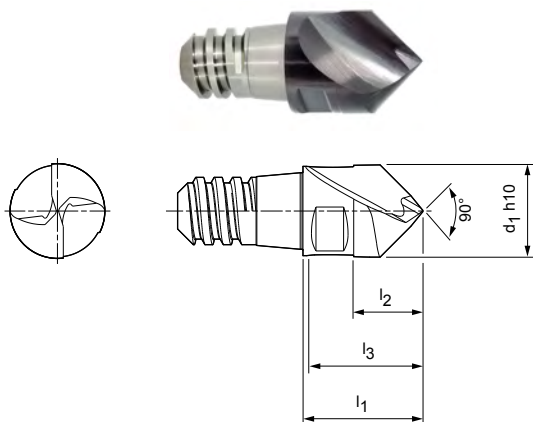

Magazynowa seria preferowana

Wymiary					z	a _p max.	SW	Specyfikacja	Nr materiałowy
d ₁ h10	Wielkość CFS	l ₁	l ₂	l ₃					
8,00	6	11	6	10	2	4	SW 6	CPD100-0800Z02-W090-06-HP338	30371388
10,00	8	13	7,5	12	2	5	SW 8	CPD100-1000Z02-W090-08-HP338	30371389
12,00	10	16	9	15	2	6	SW 10	CPD100-1200Z02-W090-10-HP338	30371390
16,00	12	20	12	18	2	8	SW 13	CPD100-1600Z02-W090-12-HP338	30371391
20,00	16	25	15	23	2	10	SW 16	CPD100-2000Z02-W090-16-HP338	30371393

Osprzęt

	Uchwyt wymiennej głowicy CFS CFS201	Strona 250
---	--	------------

Wymiary podano w mm.

Zalecane parametry skrawania - patrz koniec rozdziału.

Wersje specjalne i inne powłoki wg zapytania ofertowego.

Uchwyt wymiennej głowicy CFS

Wersja stożkowa z chłodzeniem wewnętrznym
CFS201

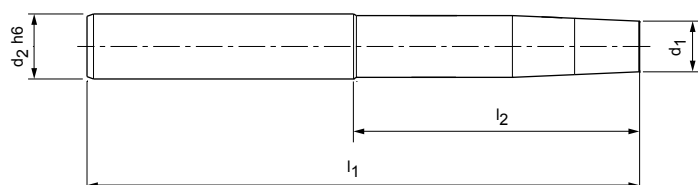

Wersja ze stali

Wielkość CFS	Wymiary				Specyfikacja	Nr materiałowy
	d_1	d_2 h6	l_1	l_2		
6	7,8	10	60	20	CFS201N-06-020-ZYL-HA10-S	30393776
8	9,8	16	70	30	CFS201N-08-030-ZYL-HA16-S	30393787
8	9,8	16	90	40	CFS201N-08-040-ZYL-HA16-S	30393788
10	11,8	16	70	30	CFS201N-10-030-ZYL-HA16-S	30393798
10	11,8	16	90	42	CFS201N-10-042-ZYL-HA16-S	30393799
12	15,8	20	80	30	CFS201N-12-030-ZYL-HA20-S	30393963
12	15,8	20	105	55	CFS201N-12-055-ZYL-HA20-S	30393964
16	19,8	25	90	40	CFS201N-16-040-ZYL-HA25-S	30393976

Wersja z węgla spiekane

6	7,8	10	110	70	CFS201N-06-070-ZYL-HA10-H	30393779
8	9,8	16	110	60	CFS201N-08-060-ZYL-HA16-H	30393790
10	11,8	20	110	60	CFS201N-10-060-ZYL-HA20-H	30393801
10	11,8	20	150	100	CFS201N-10-100-ZYL-HA20-H	30393802
12	15,8	20	130	80	CFS201N-12-080-ZYL-HA20-H	30393966
12	15,8	20	150	100	CFS201N-12-100-ZYL-HA20-H	30393967
16	19,8	25	150	94	CFS201N-16-094-ZYL-HA25-H	30393979

Zalecane parametry skrawania dla nawiertaków

Posuw i prędkość skrawania

CPD-Spot-Drill | CPD100

MZG*		Materiał obrabiany	Wytrzymałość/ twardość [N/mm ²] [HRC]	Chłodzenie			v _c [m/min]	f _z [mm]					
				Mgierka/ powietrze	Obróbka na sucho	Emulsja		Średnica wiertła [mm]					
								8,00	10,00	12,00	16,00	20,00	
P	P1	P1.1	Stale konstrukcyjne, użytkowe i uszlachetnione, stale niestopowe	< 700	✓	✓	✓	160	0,084	0,100	0,115	0,141	0,161
		P1.2	Stale konstrukcyjne, użytkowe i uszlachetnione, stale niestopowe	< 1 200	✓	✓	✓	130	0,078	0,094	0,108	0,131	0,150
	P2	P2.1	Stale azotowane, użytkowe i uszlachetnione, stale stopowe	< 900	✓	✓	✓	145	0,084	0,100	0,115	0,141	0,161
		P2.2	Stale azotowane, użytkowe i uszlachetnione, stale stopowe	< 1 400	✓		✓	100	0,070	0,084	0,096	0,117	0,134
	P3	P3.1	Stale narzędziowe, łożyskowe, sprężynowe i stale szybko tnące**	< 800	✓	✓	✓	95	0,081	0,097	0,111	0,136	0,156
		P3.2	Stale narzędziowe, łożyskowe, sprężynowe i stale szybko tnące**	< 1 000	✓		✓	85	0,077	0,092	0,106	0,129	0,148
		P3.3	Stale narzędziowe, łożyskowe, sprężynowe i stale szybko tnące**	< 1 500	✓		✓	80	0,073	0,087	0,100	0,122	0,140
	P4	P4.1	Stale nierdzewne, ferrytyczne i martenzytyczne		✓		✓	65	0,056	0,067	0,077	0,094	0,107
	P5	P5.1	Staliwo				✓	95	0,081	0,097	0,111	0,136	0,156
	P6	P6.1	Staliwo nierdzewne, ferrytyczne i martenzytyczne				✓	65	0,039	0,047	0,054	0,066	0,075
M	M1	M1.1	Stale nierdzewne, austenityczne	< 700	✓		✓	45	0,049	0,059	0,067	0,082	0,094
		M1.2	Stale nierdzewne, ferrytyczne/austenityczne (Duplex)	< 1 000			✓	40	0,040	0,048	0,056	0,068	0,078
	M2	M2.1	Staliwo nierdzewne, austenityczne	< 700	✓		✓	50	0,053	0,064	0,073	0,089	0,102
	M3	M3.1	Staliwo nierdzewne, ferrytyczne/austenityczne (Duplex)	< 1 000			✓	45	0,042	0,050	0,058	0,070	0,081
K	K1	K1.1	Żeliwo z grafitem płatkowym (żeliwo szare), GJL	< 300	✓	✓	✓	175	0,140	0,167	0,192	0,235	0,268
		K2.1	Żeliwo sferoidalne, GJS	< 500	✓	✓	✓	160	0,119	0,142	0,163	0,199	0,228
		K2.2	Żeliwo sferoidalne, GJS	500-800	✓	✓	✓	130	0,098	0,117	0,134	0,164	0,188
	K3	K2.3	Żeliwo sferoidalne, GJS	> 800	✓	✓	✓	70	0,056	0,067	0,077	0,094	0,107
		K3.1	Żeliwo wermikularne, GJV, (żeliwo ciągliwe), GJL	< 500	✓	✓	✓	115	0,098	0,117	0,134	0,164	0,188
		K3.2	Żeliwo wermikularne, GJV, (żeliwo ciągliwe), GJL	> 500	✓	✓	✓	110	0,084	0,100	0,115	0,141	0,161
N	N1	N1.1	Aluminium, niestopowe i stopowe < 3 % Si		✓	✓	✓	610	0,142	0,170	0,196	0,239	0,273
		N1.2	Aluminium, stopowe <= 7 % Si		✓	✓	✓	405	0,149	0,179	0,206	0,251	0,287
		N1.3	Aluminium, stopowe > 7-12 % Si		✓	✓	✓	325	0,156	0,187	0,215	0,263	0,301
		N1.4	Aluminium, stopowe > 12 % Si		✓	✓	✓	235	0,171	0,204	0,235	0,287	0,328
	N2	N2.1	Miedź, niestopowa i niskostopowa	< 300	✓	✓	✓	235	0,114	0,136	0,157	0,191	0,219
		N2.2	Miedź, stopowa	> 300	✓	✓	✓	175	0,114	0,136	0,157	0,191	0,219
		N2.3	Mosiądz, brąz, spiż	< 1 200	✓	✓	✓	295	0,071	0,085	0,098	0,120	0,137

* Grupa materiałowa wg MAPAL

** Jeśli składniki stopu Cr, Mo, Ni, V, W wynoszą łącznie > 8%, należy wybrać następną w kolejności grupę materiałową MAPAL.

Podane wartości robocze to wartości orientacyjne.

Optymalne wartości dla danego przypadku obróbki należy ustalić w ramach próby lub podczas obróbki.

Zalecane parametry skrawania dla nawiertaków

Posuw i prędkość skrawania

Tritan-Spot-Drill-Steel | SCD670

MZG*	Materiał obrabiany	Wytrzymałość/twardość [N/mm ²] [HRC]
P	P1.1 Stale konstrukcyjne, użytkowe i uszlachetnione, stale niestopowe	< 700
	P1.2 Stale konstrukcyjne, użytkowe i uszlachetnione, stale niestopowe	< 1 200
	P2.1 Stale azotowane, użytkowe i uszlachetnione, stale stopowe	< 900
	P2.2 Stale azotowane, użytkowe i uszlachetnione, stale stopowe	< 1 400
	P3.1 Stale narzędziowe, łożyskowe, sprężynowe i stale szybko tnące**	< 800
	P3.2 Stale narzędziowe, łożyskowe, sprężynowe i stale szybko tnące**	< 1 000
	P3.3 Stale narzędziowe, łożyskowe, sprężynowe i stale szybko tnące**	< 1 500
	P5.1 Staliwo	
M	M1.1 Stale nierdzewne, austenityczne	< 700
	M1.2 Stale nierdzewne, ferrytyczne/austenityczne (Duplex)	< 1 000
	M2.1 Staliwo nierdzewne, austenityczne	< 700
	M3.1 Staliwo nierdzewne, ferrytyczne/austenityczne (Duplex)	< 1 000
K	K1.1 Żeliwo z grafitem płatkowym (żeliwo szare), GJL	< 300
	K2.1 Żeliwo sferoidalne, GJS	< 500
	K2.2 Żeliwo sferoidalne, GJS	≤ 800
	K2.3 Żeliwo sferoidalne, GJS	> 800
	K3.1 Żeliwo wermikularne, GJV, (żeliwo ciągliwe), GJL	< 500
	K3.2 Żeliwo wermikularne, GJV, (żeliwo ciągliwe), GJL	> 500
N	N1.1 Aluminium, niestopowe i stopowe < 3 % Si	
	N1.2 Aluminium, stopowe ≤ 7 % Si	
	N1.3 Aluminium, stopowe > 7-12 % Si	
	N1.4 Aluminium, stopowe > 12 % Si	
	N2.1 Miedź, niestopowa i niskostopowa	< 300
	N2.2 Miedź, stopowa	> 300
	N2.3 Mosiądz, brąz, spiż	< 1 200
	N4.1 Tworzywo sztuczne, materiały termoplastyczne	
	N4.2 Tworzywo sztuczne, duroplast	
	N4.3 Tworzywo sztuczne, pianki	
S	S1.1 Tytan, stopy tytanu	< 400
	S2.1 Tytan, stopy tytanu	< 1 200
	S2.2 Tytan, stopy tytanu	> 1 200
	S3.1 Nikiel, niestopowy i stopowy	< 900
	S3.2 Nikiel, niestopowy i stopowy	> 900
	S4.1 Nadstop o wysokiej odporności termicznej na bazie Ni, Co i Fe	
	S5.1 Stopy wolframu i molibdenu	
H	H1.1 Stal utwardzana/staliwo	< 44
	H1.2 Stal utwardzana/staliwo	< 55

* Grupa materiałowa wg MAPAL

** Jeśli składniki stopu Cr, Mo, Ni, V, W wynoszą łącznie > 8%, należy wybrać następną w kolejności grupę materiałową MAPAL.

	Prędkość skrawania v_c [m/min]				Posuw f [mm] przy średnicy wiertła					
	Chłodzenie wewnętrzne	Chłodzenie zewnętrzne	Mgietka	Powietrze	4,00	5,50	7,50	10,50	14,50	20,00
	175	160	160		0,09	0,10	0,11	0,13	0,14	0,15
	160	130	130		0,11	0,12	0,14	0,16	0,17	0,18
	170	145	145		0,10	0,12	0,13	0,15	0,16	0,17
	120	100	100		0,08	0,09	0,11	0,12	0,13	0,14
	110	95	95		0,09	0,11	0,12	0,13	0,15	0,16
	90	85	85		0,08	0,09	0,10	0,11	0,12	0,13
	90	70	75		0,06	0,07	0,08	0,08	0,09	0,10
	110	95	95		0,10	0,12	0,13	0,15	0,16	0,17
	70	45	45		0,06	0,07	0,08	0,09	0,10	0,10
	75	50	50		0,06	0,07	0,08	0,09	0,10	0,10
	245	175	175	175	0,17	0,19	0,22	0,25	0,27	0,30
	225	140	170	170	0,16	0,18	0,20	0,23	0,25	0,27
	170	130	130		0,14	0,15	0,18	0,20	0,22	0,23
	100	70	85		0,09	0,10	0,12	0,13	0,14	0,15
	155	135	135		0,15	0,17	0,19	0,21	0,23	0,25
	135	120	120		0,12	0,13	0,15	0,17	0,19	0,20
	300	200	250		0,11	0,12	0,13	0,15	0,17	0,18
	250	180	200		0,14	0,15	0,18	0,20	0,22	0,23
	220	150	180		0,14	0,15	0,18	0,20	0,22	0,23
	180	120	150		0,14	0,15	0,18	0,20	0,22	0,23
	140	100			0,11	0,12	0,13	0,15	0,17	0,18
	120	90			0,14	0,15	0,18	0,20	0,22	0,23
	200	160	160	120	0,17	0,19	0,22	0,25	0,27	0,30
		60		50	0,09	0,10	0,12	0,13	0,14	0,15
		65		40	0,07	0,08	0,09	0,11	0,12	0,12
				400	0,07	0,08	0,09	0,11	0,12	0,12
	40	25			0,062	0,069	0,078	0,088	0,097	0,104
	30	20			0,053	0,059	0,067	0,075	0,083	0,089
	25	15			0,044	0,050	0,056	0,063	0,069	0,074
	20	15			0,035	0,040	0,045	0,050	0,055	0,059
	15	10			0,044	0,050	0,056	0,063	0,069	0,074
	15	10			0,035	0,040	0,045	0,050	0,055	0,059
	15	10			0,035	0,040	0,045	0,050	0,055	0,059
	80	80	80		0,078	0,087	0,098	0,109	0,120	0,128
	30	30	30		0,053	0,059	0,067	0,075	0,083	0,089

Podane parametry skrawania to wartości orientacyjne.

Optymalne wartości dla danego przypadku obróbki należy ustalić w ramach próby lub podczas obróbki.

Zalecane parametry skrawania dla nawiertaków

Posuw i prędkość skrawania

ECU-Centre-Drill | SCD450

MZG*		Materiał obrabiany	Wytrzymałość/twardość [N/mm ²] [HRC]
P	P1	P1.1 Stale konstrukcyjne, użytkowe i uszlachetnione, stale niestopowe	< 700
		P1.2 Stale konstrukcyjne, użytkowe i uszlachetnione, stale niestopowe	< 1 200
	P2	P2.1 Stale azotowane, użytkowe i uszlachetnione, stale stopowe	< 900
		P2.2 Stale azotowane, użytkowe i uszlachetnione, stale stopowe	< 1 400
	P3	P3.1 Stale narzędziowe, łożyskowe, sprężynowe i stale szybko tnące**	< 800
		P3.2 Stale narzędziowe, łożyskowe, sprężynowe i stale szybko tnące**	< 1 000
		P3.3 Stale narzędziowe, łożyskowe, sprężynowe i stale szybko tnące**	< 1 500
	P4	P4.1 Stale nierdzewne, ferrytyczne i martenzytyczne	
	P5	P5.1 Staliwo	
	P6	P6.1 Staliwo nierdzewne, ferrytyczne i martenzytyczne	
M	M1	M1.1 Stale nierdzewne, austenityczne	< 700
		M1.2 Stale nierdzewne, ferrytyczne/austenityczne (Duplex)	< 1 000
	M2	M2.1 Staliwo nierdzewne, austenityczne	< 700
	M3	M3.1 Staliwo nierdzewne, ferrytyczne/austenityczne (Duplex)	< 1 000
N	N2	N2.1 Miedź, niestopowa i niskostopowa	< 300
		N2.2 Miedź, stopowa	> 300
		N2.3 Mosiądz, brąz, spiż	< 1 200
S	S1	S1.1 Tytan, stopy tytanu	< 400
		S2.1 Tytan, stopy tytanu	< 1 200
	S2	S2.2 Tytan, stopy tytanu	> 1 200
		S3.1 Nikiel, niestopowy i stopowy	< 900
	S3	S3.2 Nikiel, niestopowy i stopowy	> 900
		S4	S4.1 Nadstop o wysokiej odporności termicznej na bazie Ni, Co i Fe
S5	S5.1 Stopy wolframu i molibdenu		

* Grupa materiałowa wg MAPAL

** Jeśli składniki stopu Cr, Mo, Ni, V, W wynoszą łącznie > 8%, należy wybrać następną w kolejności grupę materiałową MAPAL.

	Prędkość skrawania v_c [m/min]				Posuw f [mm] przy średnicy wiertła					
	Chłodzenie wewnętrzne	Chłodzenie zewnętrzne	Mgietka	Powietrze	0,50	0,83	1,38	2,29	3,80	6,30
		70	70		0,01	0,01	0,02	0,02	0,03	0,04
		55	55		0,01	0,02	0,02	0,03	0,04	0,06
		65	65		0,01	0,01	0,02	0,03	0,04	0,05
		45	45		0,01	0,01	0,02	0,02	0,03	0,04
		50	50		0,01	0,01	0,02	0,02	0,03	0,05
		40	40		0,01	0,01	0,02	0,02	0,03	0,04
		35	40		0,01	0,01	0,01	0,02	0,02	0,03
		35	40		0,01	0,01	0,01	0,02	0,02	0,03
		65	65		0,01	0,01	0,02	0,03	0,04	0,05
		35	40		0,01	0,01	0,01	0,02	0,02	0,03
		30	30		0,01	0,01	0,01	0,02	0,02	0,03
		25	25		0,01	0,01	0,01	0,01	0,02	0,03
		30	30		0,01	0,01	0,01	0,02	0,02	0,03
		25	25		0,01	0,01	0,01	0,01	0,02	0,03
		85			0,01	0,01	0,02	0,02	0,03	0,04
		75			0,01	0,01	0,02	0,03	0,04	0,06
		135	135		0,01	0,01	0,02	0,03	0,04	0,07
		40	40		0,01	0,01	0,02	0,02	0,03	0,04
		35	35		0,01	0,01	0,02	0,02	0,03	0,04
		30	30		0,01	0,01	0,02	0,02	0,03	0,04
		25	25		0,01	0,01	0,02	0,02	0,03	0,04
		20	20		0,01	0,01	0,02	0,02	0,03	0,04
		20	20		0,01	0,01	0,02	0,02	0,03	0,04
		20	20		0,01	0,01	0,02	0,02	0,03	0,04

Podane parametry skrawania to wartości orientacyjne.
 Optymalne wartości dla danego przypadku obróbki należy ustalić w ramach próby lub podczas obróbki.



WIERCENIE OTWORU STOPNIOWANEGO

Wiertło stopniowane

Tritan-Step-Drill-Steel	258
MEGA-Step-Drill-Steel-Plus	259

Aneks techniczny

Zalecane parametry skrawania	262
------------------------------------	-----

Tritan-Step-Drill-Steel

Wiertła stopniowane z węgla spiekanego
SCD561, wewnętrzne doprowadzenie chłodziwa

Wersja:

Średnica wiertła:	3,98 – 17,50 mm
Tolerancja otworu:	IT 9 (osiągalne)
Materiał skrawający:	HP835
Liczba ostrzy:	3
Liczba łysinek:	3
Kąt wierzchołkowy:	145°
Kąt spirali:	30°

Zastosowanie:

Dotyczy otworu gwintowanego
z pogłębieniem 90°.

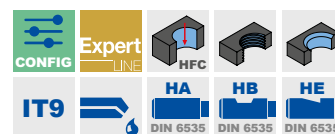
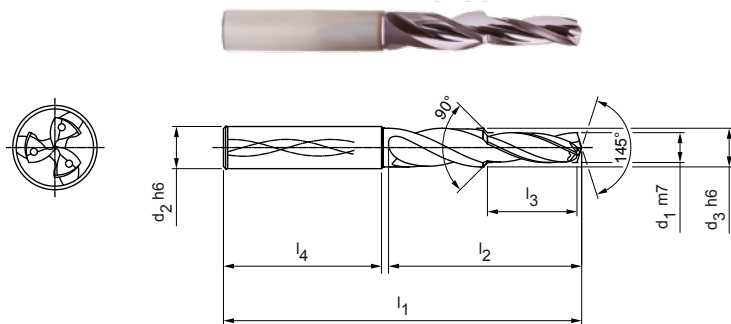

Magazynowa seria preferowana z typem chwytu HA

Dotyczy gwintu	Wymiary							Typ chwytu HA	
	d ₁ m7	d ₂ h6	d ₃ h6	l ₁	l ₂	l ₃	l ₄	Specyfikacja	Nr materiałowy
M5	4,25	6	5,5	66	28	13,6	36	SCD561-0425-3-3-145HA-HP835	31053657
M6	5,10	8	6,6	79	41	16,5	36	SCD561-0510-3-3-145HA-HP835	31053658
M8	6,85	10	8,8	89	47	21	40	SCD561-0685-3-3-145HA-HP835	31053659
M8x1	7,10	10	8,8	89	47	21	40	SCD561-0710-3-3-145HA-HP835	31073436
M10	8,60	12	11	102	55	25,5	45	SCD561-0860-3-3-145HA-HP835	31053670
M10x1	9,10	12	11	102	55	25,5	45	SCD561-0910-3-3-145HA-HP835	31073438
M12	10,35	14	13,2	107	60	30	45	SCD561-1035-3-3-145HA-HP835	31053671
M16	14,15	18	17,6	123	73	38,5	48	SCD561-1415-3-3-145HA-HP835	31053672

Możliwość konfiguracji parametrów

Średnica:
możliwość wyboru średnicy w krokach
co 0,01 mm

Długość stopnia:
Możliwość wyboru długości stopnia w
krokach co 0,01 mm

Typ chwytu:
Typ chwytu: HB | HE

Specyfikacja:
SCD561-[średnica]-3-3-145[typ chwytu]-HP835

Przykład:

SCD561-0431-3-3-145HE-HP835

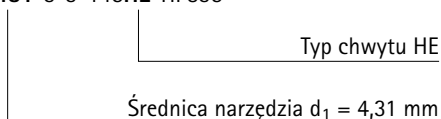

Wymiary podano w mm.

Zalecane parametry skrawania - patrz koniec rozdziału.

Wersje specjalne i inne powłoki wg zapytania ofertowego.

Wymiary typoszeregu z możliwością konfiguracji parametrów

d ₁ min.	d ₁ max.	d ₂ h6	d ₃ h6	l ₁	l ₂	l ₃ min.	l ₃ max.
3,98	4,50	6	5	66	28	4,00	15,4
4,51	5,50	6	6	66	28	4,50	15,4
5,51	6,50	8	7	79	41	5,50	22,55
6,51	7,50	8	8	79	41	6,50	22,55
7,51	8,50	10	9	89	47	7,50	25,85
8,51	9,50	10	10	89	47	8,50	25,85
9,51	11,50	12	12	102	55	9,50	30,25
11,51	13,50	14	14	107	60	11,50	33
13,51	15,50	16	16	115	65	13,50	35,75
15,51	17,50	18	18	123	73	15,50	40,15

Otwory pod gwinty z fazą 90°

wg DIN 8378 za pomocą wiertła
Tritan-Step-Drill-Steel





MEGA-STEP-DRILL-STEEL-PLUS

Ekonomiczna obróbka otworów pod gwinty (wg DIN 8378)

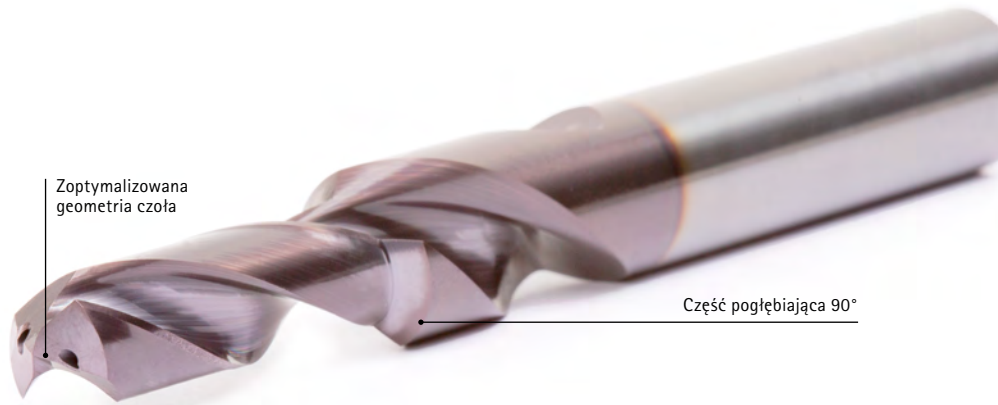
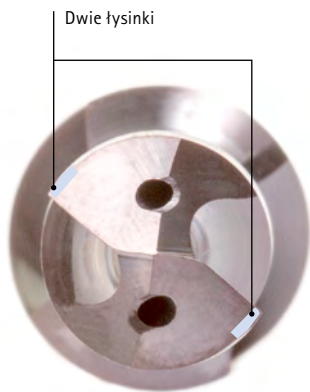

Otwór pod gwint M10

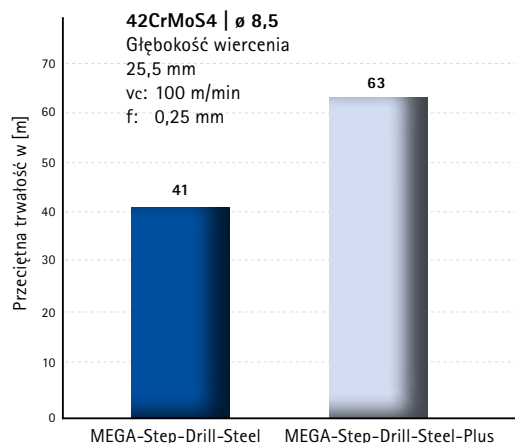

W SKRÓCIE

- Udoskonalona wersja MEGA-Step-Drill-Steel z chłodzeniem wewnętrznym i bez niego
- Innowacyjna powłoka
- Zoptymalizowana mikro- i makrogeometria
- Zakres średnicy od 2,50 do 15,00 mm

ZALETY

- O 15% wyższa prędkość skrawania*
- O 15% wyższy posuw*
- O 50% większa wytrzymałość*

* W porównaniu z poprzednim modelem

MEGA-Step-Drill-Steel-Plus

Wiertła stopniowane z węgla spiekane

SCD590, zewnętrzne doprowadzenie chłodziwa, następca MEGA-Step-Drill-Steel

Wersja:

Średnica wiertła: 2,50 – 14,00 mm

Materiał skrawający: HP358

Liczba ostrzy: 2

Liczba łysinek: 2

Kąt wierzchołkowy: 140°

Kąt spirali: 30°

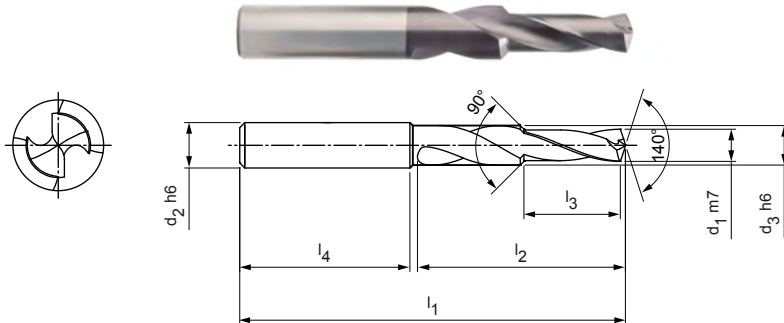

Magazynowa seria preferowana z typem chwytu HA

Dotyczy gwintu	Rodzaj	Wymiary							Typ chwytu HA	
		d ₁ m7	d ₂ h6	d ₃ h6	l ₁	l ₂	l ₃	l ₄	Specyfikacja	Nr materiałowy
M3	GB	2,50	6	6,00	62	20	8,8	36	SCD590-0250-2-2-140HA-HP358	31228957
M3	FO	2,80	6	6,00	62	20	8,8	36	SCD590-0280-2-2-140HA-HP358	31228958
M4	GB	3,30	6	6,00	62	24	11,4	36	SCD590-0330-2-2-140HA-HP358	31228959
M4	FO	3,70	6	6,00	62	24	11,4	36	SCD590-0370-2-2-140HA-HP358	31228960
M5	GB	4,20	6	6,00	66	28	13,6	36	SCD590-0420-2-2-140HA-HP358	31228961
M5	FO	4,65	6	6,00	66	28	13,6	36	SCD590-0465-2-2-140HA-HP358	31228962
M6	GB	5,00	8	8,00	79	34	16,5	36	SCD590-0500-2-2-140HA-HP358	31149619
M6	FO	5,55	8	8,00	79	34	16,5	36	SCD590-0555-2-2-140HA-HP358	31228963
M8	GB	6,80	10	10,00	89	47	21	40	SCD590-0680-2-2-140HA-HP358	31141315
M8	FO	7,45	10	10,00	89	47	21	40	SCD590-0745-2-2-140HA-HP358	31228964
M10	GB	8,50	12	12,00	102	55	25,5	45	SCD590-0850-2-2-140HA-HP358	31228965
M10	FO	9,30	12	12,00	102	55	25,5	45	SCD590-0930-2-2-140HA-HP358	31228966
M12	GB	10,20	14	14,00	107	60	30	45	SCD590-1020-2-2-140HA-HP358	31228967
M12	FO	11,20	14	14,00	107	60	30	45	SCD590-1120-2-2-140HA-HP358	31228968
M14	GB	12,00	16	16,00	115	65	34,5	48	SCD590-1200-2-2-140HA-HP358	31149650
M16	GB	14,00	18	18,00	123	73	38,5	48	SCD590-1400-2-2-140HA-HP358	31228970

GB: nawiercanie gwintu w otworze | FO: formowanie gwintu w otworze / wygniatanie gwintu w otworze

Możliwość konfiguracji parametrów



Typ chwytu:
Typ chwytu: HB | HE

Specyfikacja:
SCD590-0420-2-2-140[typ chwytu]-HP358

Przykład:

SCD590-0420-2-2-140HE05-HP358

Typ chwytu HE

Wymiary podano w mm.

Zalecane parametry skrawania - patrz koniec rozdziału.

Wersje specjalne i inne powłoki wg zapytania ofertowego.

MEGA-Step-Drill-Steel-Plus

Wiertła stopniowane z węgla spiekanego
SCD591, wewnętrzne doprowadzenie chłodziwa, następca MEGA-Step-Drill-Steel

Wersja:
Średnica wiertła: 3,30 - 14,00 mm
Materiał skrawający: HP358
Liczba ostrzy: 2
Liczba łysinek: 2
Kąt wierzchołkowy: 140°
Kąt spirali: 30°

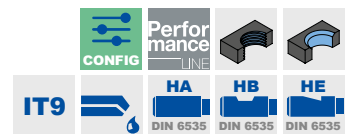
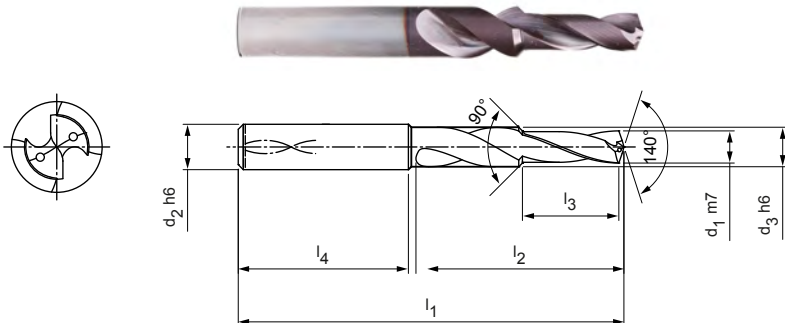

Magazynowa seria preferowana z typem chwytu HA

Dotyczy gwintu	Rodzaj	Wymiary							Typ chwytu HA	
		d ₁ m7	d ₂ h6	d ₃ h6	l ₁	l ₂	l ₃	l ₄	Specyfikacja	Nr materiałowy
M4	GB	3,30	6	6,00	62	24	11,4	36	SCD591-0330-2-2-140HA-HP358	31140987
M4	FO	3,70	6	6,00	62	24	11,4	36	SCD591-0370-2-2-140HA-HP358	31140988
M5	GB	4,20	6	6,00	66	28	13,6	36	SCD591-0420-2-2-140HA-HP358	31140989
M6	GB	5,00	8	8,00	79	34	16,5	36	SCD591-0500-2-2-140HA-HP358	31140991
M6	FO	5,55	8	8,00	79	34	16,5	36	SCD591-0555-2-2-140HA-HP358	31140992
M8	GB	6,80	10	10,00	89	47	21	40	SCD591-0680-2-2-140HA-HP358	31140993
M8	FO	7,45	10	10,00	89	47	21	40	SCD591-0745-2-2-140HA-HP358	31140994
M10	GB	8,50	12	12,00	102	55	25,5	45	SCD591-0850-2-2-140HA-HP358	31140995
M10	FO	9,30	12	12,00	102	55	25,5	45	SCD591-0930-2-2-140HA-HP358	31140996
M12	GB	10,20	14	14,00	107	60	30	45	SCD591-1020-2-2-140HA-HP358	31140997
M12	GB	10,20	14	14,00	107	60	30	45	SCD591-1020-2-2-140HA-HP358	31140997

Dostępne na życzenie

M12	FO	11,20	14	14,00	107	60	30	45	SCD591-1120-2-2-140HA-HP358	31140998
M16	GB	14,00	18	18,00	123	73	38,5	48	SCD591-1400-2-2-140HA-HP358	31140999

GB: nawiercanie gwintu w otworze | FO: formowanie gwintu w otworze / wygniatanie gwintu w otworze

Możliwość konfiguracji parametrów

Typ chwytu:
Typ chwytu: HB | HE

Specyfikacja:
SCD591-0420-2-2-140[typ chwytu]-HP358

Przykład:
SCD591-0420-2-2-140HE05-HP358

Typ chwytu HE

Wymiary podano w mm.

Zalecane parametry skrawania - patrz koniec rozdziału.

Wersje specjalne i inne powłoki wg zapytania ofertowego.

Zalecane parametry skrawania dla wiertel stopniowanych

Posuw i prędkość skrawania

Tritan-Step-Drill-Steel | SCD561

MZG*	Materiał obrabiany	Wytrzymałość/twardość [N/mm ²] [HRC]
P	P1.1 Stale konstrukcyjne, użytkowe i uszlachetnione, stale niestopowe	< 700
	P1.2 Stale konstrukcyjne, użytkowe i uszlachetnione, stale niestopowe	< 1 200
	P2.1 Stale azotowane, użytkowe i uszlachetnione, stale stopowe	< 900
	P2.2 Stale azotowane, użytkowe i uszlachetnione, stale stopowe	< 1 400
	P3.1 Stale narzędziowe, łożyskowe, sprężynowe i stale szybko tnące**	< 800
	P3.2 Stale narzędziowe, łożyskowe, sprężynowe i stale szybko tnące**	< 1 000
	P3.3 Stale narzędziowe, łożyskowe, sprężynowe i stale szybko tnące**	< 1 500
	P5.1 Staliwo	
M	M1.1 Stale nierdzewne, austenityczne	< 700
	M1.2 Stale nierdzewne, ferrytyczne/austenityczne (Duplex)	< 1 000
K	K1.1 Żeliwo z grafitem płatkowym (żeliwo szare), GJL	< 300
	K2.1 Żeliwo sferoidalne, GJS	< 500
	K2.2 Żeliwo sferoidalne, GJS	≤ 800
	K2.3 Żeliwo sferoidalne, GJS	> 800
	K3.1 Żeliwo wermikularne, GJV, (żeliwo ciągliwe), GJL	< 500
	K3.2 Żeliwo wermikularne, GJV, (żeliwo ciągliwe), GJL	> 500

* Grupa materiałowa wg MAPAL

** Jeśli składniki stopu Cr, Mo, Ni, V, W wynoszą łącznie > 8%, należy wybrać następną w kolejności grupę materiałową MAPAL.

	Prędkość skrawania v_c [m/min]				Posuw f [mm] przy średnicy wiertła					
	Chłodzenie wewnętrzne	Chłodzenie zewnętrzne	Mgietka	Powietrze	4,00	5,50	7,50	10,50	14,50	20,00
	115	105	105		0,24	0,30	0,37	0,46	0,56	0,65
	105	85	85		0,30	0,37	0,46	0,58	0,70	0,81
	115	100	100		0,28	0,35	0,44	0,55	0,66	0,77
	80	70	70		0,24	0,29	0,36	0,44	0,53	0,61
	85	75	75		0,25	0,31	0,39	0,49	0,60	0,69
	70	65	65		0,21	0,26	0,33	0,41	0,49	0,56
	70	50	60		0,18	0,21	0,26	0,32	0,38	0,43
	115	100	100		0,28	0,35	0,44	0,55	0,66	0,77
	55	35	35		0,11	0,14	0,18	0,22	0,27	0,31
	140	100	100	100	0,36	0,45	0,55	0,67	0,80	0,91
	185	115	140	140	0,35	0,43	0,52	0,63	0,74	0,84
	115	85	85		0,31	0,38	0,46	0,55	0,64	0,73
	70	45	60		0,17	0,20	0,24	0,28	0,33	0,37
	105	90	90		0,34	0,41	0,49	0,59	0,69	0,78
	90	80	80		0,28	0,34	0,40	0,47	0,55	0,62

Podane parametry skrawania to wartości orientacyjne.

Optymalne wartości dla danego przypadku obróbki należy ustalić w ramach próby lub podczas obróbki.

Zalecane parametry skrawania dla wiertel stopniowanych

Posuw i prędkość skrawania

MEGA-Step-Drill-Steel-Plus | SCD590, 591

MZG*		Materiał obrabiany	Wytrzymałość/twardość [N/mm ²] [HRC]	
P	P1	P1.1 Stale konstrukcyjne, użytkowe i uszlachetnione, stale niestopowe	< 700	
		P1.2 Stale konstrukcyjne, użytkowe i uszlachetnione, stale niestopowe	< 1 200	
	P2	P2.1 Stale azotowane, użytkowe i uszlachetnione, stale stopowe	< 900	
		P2.2 Stale azotowane, użytkowe i uszlachetnione, stale stopowe	< 1 400	
	P3	P3.1 Stale narzędziowe, łożyskowe, sprężynowe i stale szybko tnące**	< 800	
		P3.2 Stale narzędziowe, łożyskowe, sprężynowe i stale szybko tnące**	< 1 000	
		P3.3 Stale narzędziowe, łożyskowe, sprężynowe i stale szybko tnące**	< 1 500	
	P4	P4.1 Stale nierdzewne, ferrytyczne i martenzytyczne		
	P5	P5.1 Staliwo		
	P6	P6.1 Staliwo nierdzewne, ferrytyczne i martenzytyczne		
	K	K1	K1.1 Żeliwo z grafitem płatkowym (żeliwo szare), GJL	< 300
			K1.2 Żeliwo sferoidalne, GJS	< 500
K2		K2.2 Żeliwo sferoidalne, GJS	≤ 800	
		K2.3 Żeliwo sferoidalne, GJS	> 800	
K3		K3.1 Żeliwo wermikularne, GJV, (żeliwo ciągliwe), GJL	< 500	
		K3.2 Żeliwo wermikularne, GJV, (żeliwo ciągliwe), GJL	> 500	
H	H1	H1.1 Stal utwardzana/staliwo	< 44	
		H1.2 Stal utwardzana/staliwo	< 55	

* Grupa materiałowa wg MAPAL

** Jeśli składniki stopu Cr, Mo, Ni, V, W wynoszą łącznie > 8%, należy wybrać następną w kolejności grupę materiałową MAPAL.

	Prędkość skrawania v_c [m/min]				Posuw f [mm] przy średnicy wiertła					
	Chłodzenie wewnętrzne	Chłodzenie zewnętrzne	Mgietka	Powietrze	2,50	3,70	5,00	7,45	10,20	15,00
	110	100	100		0,09	0,11	0,14	0,18	0,23	0,29
	100	85	85		0,11	0,14	0,18	0,23	0,29	0,36
	110	95	95		0,10	0,13	0,17	0,22	0,27	0,34
	75	65	65		0,09	0,11	0,14	0,18	0,22	0,27
	85	70	70		0,09	0,11	0,15	0,19	0,25	0,30
	65	60	60		0,08	0,10	0,13	0,16	0,20	0,25
	65	50	55		0,07	0,08	0,10	0,13	0,16	0,19
	65	50	55		0,06	0,08	0,10	0,13	0,16	0,20
	110	95	95		0,10	0,13	0,17	0,22	0,27	0,34
	65	50	55		0,06	0,08	0,10	0,13	0,16	0,20
	120	85	85	85	0,13	0,19	0,26	0,35	0,45	0,54
	160	100	120	120	0,13	0,18	0,25	0,33	0,42	0,50
	100	75	75		0,12	0,16	0,22	0,28	0,36	0,43
	60	40	50		0,09	0,12	0,15	0,19	0,24	0,28
	90	80	80		0,13	0,18	0,23	0,31	0,39	0,46
	80	70	70		0,11	0,15	0,19	0,25	0,31	0,36
	90	90	90		0,08	0,10	0,13	0,16	0,20	0,25
	25	25	25		0,04	0,05	0,07	0,09	0,11	0,14

Podane parametry skrawania to wartości orientacyjne.

Optymalne wartości dla danego przypadku obróbki należy ustalić w ramach próby lub podczas obróbki.



WIERCENIE GŁĘBOKICH OTWORÓW



Wiertło do głębokiego wiercenia

MEGA-Pilot-Drill	268
MEGA-Deep-Drill	269
MEGA-Deep-Drill-Alu	278

Aneks techniczny

Zalecane parametry skrawania	284
Informacje dotyczące zastosowania – wiertła do głębokiego wiercenia ..	742

MEGA-Pilot-Drill

Wiertła stopniowane z węgla spiekane
SCD581, wewnętrzne doprowadzenie chłodziwa

Wersja:

Średnica wiertła: 1,00 – 3,00 mm
Tolerancja otworu: IT 9 (osiągalne)
Materiał skrawający: HP246
Liczba ostrzy: 2
Liczba łysinek: 2
Kąt wierzchołkowy: 142°

Zastosowanie:

Wiertło pilotujące, dostosowane do
MEGA-Deep-Drill.
Maksymalny zakres zastosowania do średnicy
3,00 mm.

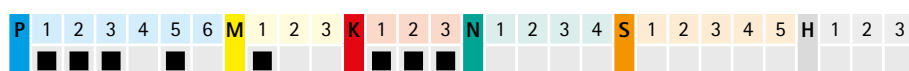
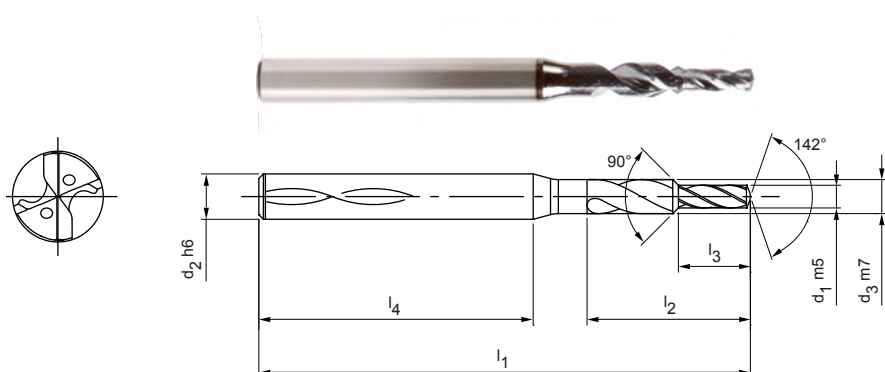

Magazynowa seria preferowana z typem chwytu HA

Wymiary							Typ chwytu HA	
d ₁ m5	d ₂ h6	d ₃ m7	l ₁	l ₂	l ₃	l ₄	Specyfikacja	Nr materiałowy
1,00	3	1,5	50	7,2	3	38	SCD581-0100-2-2-142HA-HP246	31080870
1,10	3	1,65	50	7,9	3,3	37,5	SCD581-0110-2-2-142HA-HP246	31080871
1,20	3	1,8	50	8,6	3,6	36,9	SCD581-0120-2-2-142HA-HP246	31080872
1,30	3	1,95	50	9,4	3,9	36,3	SCD581-0130-2-2-142HA-HP246	31080873
1,40	3	2,1	50	10,1	4,2	35,7	SCD581-0140-2-2-142HA-HP246	31080874
1,50	3	2,25	50	10,8	4,5	35,1	SCD581-0150-2-2-142HA-HP246	31080875
1,60	3	2,4	50	11,5	4,8	34,6	SCD581-0160-2-2-142HA-HP246	31080876
1,70	3	2,55	50	12,2	5,1	34	SCD581-0170-2-2-142HA-HP246	31080877
1,80	3	2,7	50	13	5,4	33,4	SCD581-0180-2-2-142HA-HP246	31080878
1,90	4	2,85	55	13,7	5,7	35,9	SCD581-0190-2-2-142HA-HP246	31080879
2,00	4	3	55	14,4	6	35,3	SCD581-0200-2-2-142HA-HP246	31080880
2,10	4	3,15	55	15,1	6,3	34,8	SCD581-0210-2-2-142HA-HP246	31080881
2,20	4	3,3	55	15,8	6,6	34,2	SCD581-0220-2-2-142HA-HP246	31080882
2,30	4	3,45	55	16,6	6,9	33,6	SCD581-0230-2-2-142HA-HP246	31080883
2,40	4	3,6	55	17,3	7,2	33	SCD581-0240-2-2-142HA-HP246	31080884
2,50	4	3,75	55	18	7,5	32,4	SCD581-0250-2-2-142HA-HP246	31080885
2,60	6	3,9	66	18,7	7,8	39,1	SCD581-0260-2-2-142HA-HP246	31080886
2,70	6	4,05	66	19,4	8,1	38,5	SCD581-0270-2-2-142HA-HP246	31080887
2,80	6	4,2	66	20,2	8,4	37,9	SCD581-0280-2-2-142HA-HP246	31080888
2,90	6	4,35	66	20,9	8,7	37,4	SCD581-0290-2-2-142HA-HP246	31080889
3,00	6	4,5	66	21,6	9	36,8	SCD581-0300-2-2-142HA-HP246	31080890

Wymiary podano w mm.

Zalecane parametry skrawania - patrz koniec rozdziału.

Wersje specjalne i inne powłoki wg zapytania ofertowego.

MEGA-Deep-Drill

Wiertła spiralne z węgla spiekanego
SCD171 (20xD), wewnętrzne doprowadzenie chłodziwa

Wersja:
Średnica wiertła: 1,00 – 2,99 mm
Tolerancja otworu: \geq IT 9
Materiał skrawający: HP246
Liczba ostrzy: 2
Liczba łysinek: 4
Kąt wierzchołkowy: 135°
Kąt spirali: 30°
Cechy szczególne: Powłoka głowicy

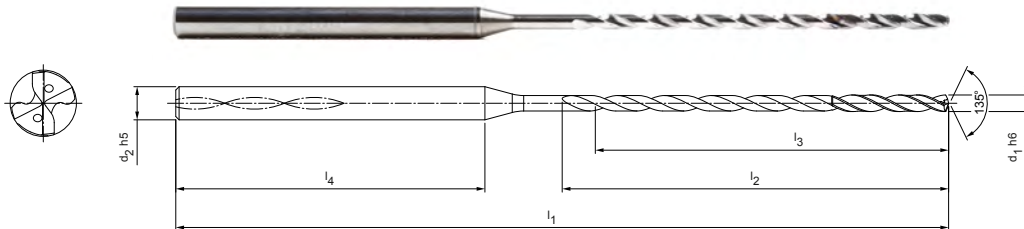

Magazynowa seria preferowana z typem chwytu HA

Wymiary						Stosunek L/d	Typ chwytu HA	
d ₁ h6	d ₂ h5	l ₁	l ₂	l ₃	l ₄		Specyfikacja	Nr materiałowy
1,00	3	62	27	25	28	28	SCD171-0100-2-4-135HA20-HP246	30998795
1,10	3	62	27	25	28	28	SCD171-0110-2-4-135HA20-HP246	30998796
1,20	3	62	27	25	28	28	SCD171-0120-2-4-135HA20-HP246	30998798
1,30	3	70	35	33	28	28	SCD171-0130-2-4-135HA20-HP246	30998799
1,40	3	70	35	32	28	28	SCD171-0140-2-4-135HA20-HP246	30998800
1,50	3	70	35	32	28	28	SCD171-0150-2-4-135HA20-HP246	30998801
1,60	3	75	41	38	28	28	SCD171-0160-2-4-135HA20-HP246	30998802
1,70	3	75	41	38	28	28	SCD171-0170-2-4-135HA20-HP246	30998803
1,80	3	75	41	38	28	28	SCD171-0180-2-4-135HA20-HP246	30998804
1,90	3	80	46	43	28	28	SCD171-0190-2-4-135HA20-HP246	30998805
2,00	3	80	46	43	28	28	SCD171-0200-2-4-135HA20-HP246	30998806
2,10	3	80	46	42	28	28	SCD171-0210-2-4-135HA20-HP246	30998807
2,20	3	90	55	51	28	28	SCD171-0220-2-4-135HA20-HP246	30998808
2,30	3	90	55	51	28	28	SCD171-0230-2-4-135HA20-HP246	30998809
2,40	3	90	55	51	28	28	SCD171-0240-2-4-135HA20-HP246	30998810
2,50	3	90	55	51	28	28	SCD171-0250-2-4-135HA20-HP246	30998811
2,60	3	100	66	62	28	28	SCD171-0260-2-4-135HA20-HP246	30998812
2,70	3	100	66	61	28	28	SCD171-0270-2-4-135HA20-HP246	30998813
2,80	3	100	66	61	28	28	SCD171-0280-2-4-135HA20-HP246	30998814
2,90	3	100	66	61	28	28	SCD171-0290-2-4-135HA20-HP246	30998815

ciąg dalszy na następnej stronie.

Zalecenie dla wiertła pilotującego:

Jako wiertła pilotujące należy użyć wiertła MEGA-Pilot-Drill (SCD581) lub MICRO-Drill-Steel (SCD371 - 5xD) o takiej samej średnicy znamionowej.

Kąt wierzchołkowy i tolerancja średnicy wiertła pilotującego i wiertła do głębokiego wiercenia zostały odpowiednio dopasowane, aby zagwarantować ich optymalną funkcjonalność i współdziałanie.

MEGA-Deep-Drill | Wiertło spiralne z węglika spiekane SCD171 (20xD), wewnętrzny dopływ środka chłodzącego

Możliwość konfiguracji parametrów



Średnica:
możliwość wyboru średnicy w krokach
co 0,01 mm

**Specyfikacja:**

SCD171-[średnica]-2-4-135HA20-HP246

Przykład:

SCD171-0221-2-4-135HA20-HP246

Średnica narzędzia $d_1 = 2,21$ mm

Wymiary typoszeregu z możliwością konfiguracji parametrów

d_1 min.	d_1 maks.	d_2 h6	l_1	l_2	l_3	l_4
1,00	1,29	3	62	27	25	28
1,30	1,39	3	70	35	33	28
1,40	1,59	3	70	35	32	28
1,60	1,89	3	75	41	38	28
1,90	2,09	3	80	46	43	28
2,10	2,19	3	80	46	42	28
2,20	2,59	3	90	55	51	28
2,60	2,69	3	100	66	62	28
2,70	2,99	3	100	66	61	28

Informacje techniczne dotyczące wiercenia głębokich otworów zamieszczono w rozdziale zatytułowanym „Aneks techniczny”.

Wymiary podano w mm.

Zalecane parametry skrawania - patrz koniec rozdziału.

Wersje specjalne i inne powłoki wg zapytania ofertowego.

MEGA-Deep-Drill

Wiertła spiralne z węgla spiekanego
SCD171 (30xD), wewnętrzne doprowadzenie chłodziwa

Wersja:
Średnica wiertła: 1,00 – 2,99 mm
Tolerancja otworu: \geq IT 9
Materiał skrawający: HP246
Liczba ostrzy: 2
Liczba łysinek: 4
Kąt wierzchołkowy: 135°
Kąt spirali: 30°
Cechy szczególne: Powłoka głowicy

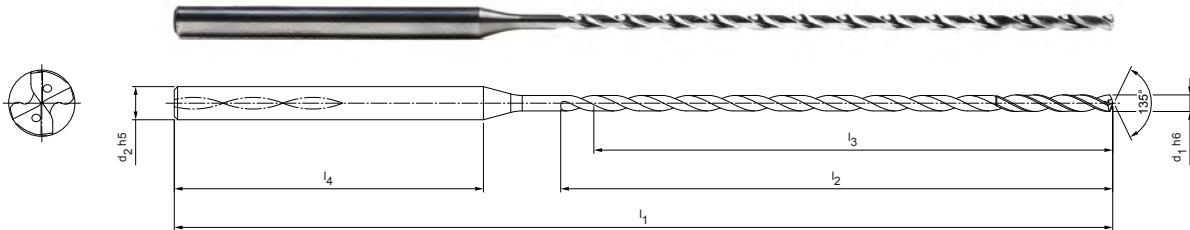

Magazynowa seria preferowana z typem chwytu HA

Wymiary						Stosunek L/d	Typ chwytu HA	
d ₁ h6	d ₂ h5	l ₁	l ₂	l ₃	l ₄		Specyfikacja	Nr materiałowy
1,00	3	75	38	36	28	36	SCD171-0100-2-4-135HA30-HP246	30998816
1,10	3	75	38	36	28	33	SCD171-0110-2-4-135HA30-HP246	30998817
1,20	3	75	38	36	28	30	SCD171-0120-2-4-135HA30-HP246	30998818
1,30	3	85	50	48	28	37	SCD171-0130-2-4-135HA30-HP246	30998819
1,40	3	85	50	47	28	34	SCD171-0140-2-4-135HA30-HP246	30998820
1,50	3	85	50	47	28	31	SCD171-0150-2-4-135HA30-HP246	30998821
1,60	3	95	59	56	28	35	SCD171-0160-2-4-135HA30-HP246	30998822
1,70	3	95	59	56	28	33	SCD171-0170-2-4-135HA30-HP246	30998823
1,80	3	95	59	56	28	31	SCD171-0180-2-4-135HA30-HP246	30998824
1,90	3	100	66	63	28	33	SCD171-0190-2-4-135HA30-HP246	30998825
2,00	3	100	66	63	28	32	SCD171-0200-2-4-135HA30-HP246	30998826
2,10	3	100	66	62	28	30	SCD171-0210-2-4-135HA30-HP246	30998827
2,20	3	115	80	76	28	35	SCD171-0220-2-4-135HA30-HP246	30998828
2,30	3	115	80	76	28	33	SCD171-0230-2-4-135HA30-HP246	30998829
2,40	3	115	80	76	28	32	SCD171-0240-2-4-135HA30-HP246	30998830
2,50	3	115	80	76	28	30	SCD171-0250-2-4-135HA30-HP245	30451572
2,60	3	130	96	92	28	35	SCD171-0260-2-4-135HA30-HP246	30998832
2,70	3	130	96	91	28	34	SCD171-0270-2-4-135HA30-HP246	30998833
2,80	3	130	96	91	28	33	SCD171-0280-2-4-135HA30-HP246	30998834
2,90	3	130	96	91	28	31	SCD171-0290-2-4-135HA30-HP246	30998835

ciąg dalszy na następnej stronie.

Zalecenie dla wiertła pilotującego:

Jako wiertła pilotującego należy użyć wiertła MEGA-Pilot-Drill (SCD581) lub MICRO-Drill-Steel (SCD371 - 5xD) o takiej samej średnicy znamionowej.

Kąt wierzchołkowy i tolerancja średnicy wiertła pilotującego i wiertła do głębokiego wiercenia zostały odpowiednio dopasowane, aby zagwarantować ich optymalną funkcjonalność i współdziałanie.

MEGA-Deep-Drill | Wiertło spiralne z węgla spiekane SCD171 (20xD), wewnętrzny dopływ środka chłodzącego

Możliwość konfiguracji parametrów



Średnica:
możliwość wyboru średnicy w krokach
co 0,01 mm



Specyfikacja:
SCD171-[średnica]-2-4-135HA30-HP246

Przykład:

SCD171-0221-2-4-135HA30-HP246

Średnica narzędzia $d_1 = 2,21$ mm

Wymiary typoszeregu z możliwością konfiguracji parametrów

d_1 min.	d_1 maks.	d_2 h6	l_1	l_2	l_3	l_4
1,00	1,29	3	75	38	36	28
1,30	1,39	3	85	50	48	28
1,40	1,59	3	85	50	47	28
1,60	1,89	3	95	59	56	28
1,90	2,09	3	100	66	63	28
2,10	2,19	3	100	66	62	28
2,20	2,59	3	115	80	76	28
2,60	2,69	3	130	96	92	28
2,70	2,99	3	130	96	91	28

Informacje techniczne dotyczące wiercenia głębokich otworów zamieszczono w rozdziale zatytułowanym „Aneks techniczny”.

Wymiary podano w mm.

Zalecane parametry skrawania - patrz koniec rozdziału.

Wersje specjalne i inne powłoki wg zapytania ofertowego.

MEGA-Deep-Drill

Wiertła spiralne z węgla spiekane
SCD171 (15xD), wewnętrzne doprowadzenie chłodziwa

Wersja:
Średnica wiertła: 3,00 - 15,00 mm
Tolerancja otworu: \geq IT 9
Materiał skrawający: HP285 / HP245
Liczba ostrzy: 2
Liczba łysinek: 4
Kąt wierzchołkowy: 135°
Kąt spirali: 30°

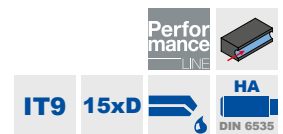
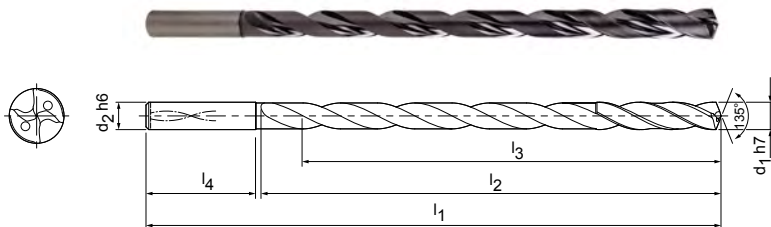

Magazynowa seria preferowana z typem chwytu HA

Wymiary						Stosunek L/d	Typ chwytu HA	
d ₁ h7	d ₂ h6	l ₁	l ₂	l ₃	l ₄		Specyfikacja	Nr materiałowy
3,00	4	90	56	52	32	17	SCD171-0300-2-4-135HA15-HP285	30392214
3,50	4	100	66	61	32	17	SCD171-0350-2-4-135HA15-HP285	30392215
4,00	4	100	66	60	32	15	SCD171-0400-2-4-135HA15-HP285	30392216
4,50	5	110	74	67	34	15	SCD171-0450-2-4-135HA15-HP285	30392217
5,00	5	120	84	77	34	15	SCD171-0500-2-4-135HA15-HP285	30392218
5,50	6	130	92	84	36	15	SCD171-0550-2-4-135HA15-HP285	30392219
6,00	6	140	102	93	36	16	SCD171-0600-2-4-135HA15-HP285	30392220
7,00	7	155	115	105	38	15	SCD171-0700-2-4-135HA15-HP285	30392221
8,00	8	175	133	121	40	15	SCD171-0800-2-4-135HA15-HP285	30392222
9,00	9	190	148	135	40	15	SCD171-0900-2-4-135HA15-HP285	30392223
9,50	10	210	168	153	40	15	SCD171-0950-2-4-135HA15-HP245	30453021
10,00	10	210	168	153	40	15	SCD171-1000-2-4-135HA15-HP285	30392224
11,00	11	230	183	167	45	15	SCD171-1100-2-4-135HA15-HP245	30392225
12,00	12	250	203	185	45	15	SCD171-1200-2-4-135HA15-HP245	30392226
13,00	13	265	218	199	45	15	SCD171-1300-2-4-135HA15-HP245	30392227
14,00	14	285	233	212	50	15	SCD171-1400-2-4-135HA15-HP245	30392228
15,00	15	305	253	231	50	15	SCD171-1500-2-4-135HA15-HP245	30392229

Zalecenie dla wiertła pilotującego:

Jako wiertła pilotującego należy użyć wiertła MEGA-Drill-Steel-Plus (SCD601 – 3xD) o takiej samej średnicy znamionowej.

Kąt wierzchołkowy i tolerancja średnicy wiertła pilotującego i wiertła do głębokiego wiercenia zostały odpowiednio dopasowane, aby zagwarantować ich optymalną funkcjonalność i współdziałanie.

Informacje techniczne dotyczące wiercenia głębokich otworów zamieszczono w rozdziale zatytułowanym „Aneks techniczny”.

Wymiary podano w mm.

Zalecane parametry skrawania – patrz koniec rozdziału.

Wersje specjalne i inne powłoki wg zapytania ofertowego.

MEGA-Deep-Drill

Wiertła spiralne z węgla spiekane
SCD171 (20xD), wewnętrzne doprowadzenie chłodziwa

Wersja:

Średnica wiertła: 3,00 – 16,00 mm
Tolerancja otworu: \geq IT 9
Materiał skrawający: HP245 / HP285
Liczba ostrzy: 2
Liczba łysinek: 4
Kąt wierzchołkowy: 135°
Kąt spirali: 30°

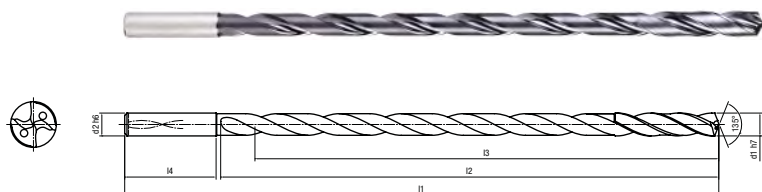

Magazynowa seria preferowana z typem chwytu HA

Wymiary						Stosunek L/d	Typ chwytu HA	
d ₁ h7	d ₂ h6	l ₁	l ₂	l ₃	l ₄		Specyfikacja	Nr materiałowy
3,00	4	110	74	70	32	23	SCD171-0300-2-4-135HA20-HP285	30392231
3,50	4	120	86	81	32	23	SCD171-0350-2-4-135HA20-HP285	30392232
4,00	4	120	86	80	32	20	SCD171-0400-2-4-135HA20-HP285	30392233
5,00	5	145	109	102	34	20	SCD171-0500-2-4-135HA20-HP285	30392235
5,50	6	160	120	112	36	20	SCD171-0550-2-4-135HA20-HP285	30392236
6,00	6	170	130	121	36	20	SCD171-0600-2-4-135HA20-HP285	30392237
6,50	7	190	150	140	36	20	SCD171-0650-2-4-135HA20-HP245	30451508
7,00	7	190	150	140	38	20	SCD171-0700-2-4-135HA20-HP285	30392238
8,00	8	215	173	161	40	20	SCD171-0800-2-4-135HA20-HP285	30392239
9,00	9	240	196	183	40	20	SCD171-0900-2-4-135HA20-HP285	30392240
10,00	10	260	218	203	40	20	SCD171-1000-2-4-135HA20-HP285	30392241
11,00	11	285	238	222	45	20	SCD171-1100-2-4-135HA20-HP245	30392242
12,00	12	305	258	240	45	20	SCD171-1200-2-4-135HA20-HP245	30392243
14,00	14	355	303	282	50	20	SCD171-1400-2-4-135HA20-HP245	30392245
15,00	15	375	323	301	50	20	SCD171-1500-2-4-135HA20-HP245	30392246
16,00	16	400	348	324	50	20	SCD171-1600-2-4-135HA20-HP245	30392247

Zalecenie dla wiertła pilotującego:

Jako wiertła pilotujące należy użyć wiertła MEGA-Drill-Steel-Plus (SCD601 – 3xD) o takiej samej średnicy znamionowej.

Kąt wierzchołkowy i tolerancja średnicy wiertła pilotującego i wiertła do głębokiego wiercenia zostały odpowiednio dopasowane, aby zagwarantować ich optymalną funkcjonalność i współdziałanie.

Informacje techniczne dotyczące wiercenia głębokich otworów zamieszczono w rozdziale zatytułowanym „Aneks techniczny”.

Wymiary podano w mm.

Zalecane parametry skrawania – patrz koniec rozdziału.

Wersje specjalne i inne powłoki wg zapytania ofertowego.

MEGA-Deep-Drill

Wiertła spiralne z węgla spiekane
SCD171 (25xD), wewnętrzne doprowadzenie chłodziwa

Wersja:

Średnica wiertła:	3,00 – 14,00 mm
Tolerancja otworu:	≥ IT 9
Materiał skrawający:	HP285 / HP245
Liczba ostrzy:	2
Liczba tyśinek:	4
Kąt wierzchołkowy:	135°
Kąt spirali:	30°

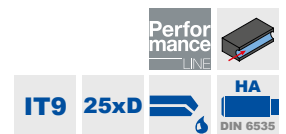
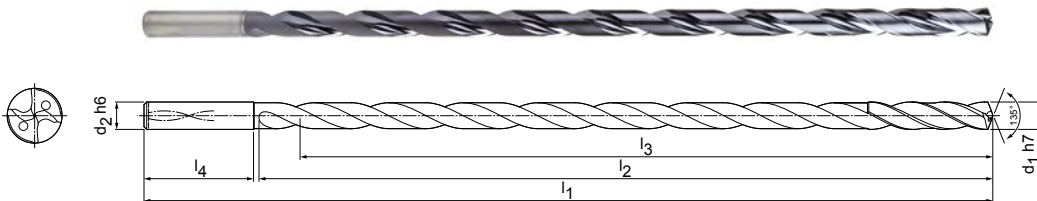

Magazynowa seria preferowana z typem chwytu HA

Wymiary						Stosunek L/d	Typ chwytu HA	
d ₁ h7	d ₂ h6	l ₁	l ₂	l ₃	l ₄		Specyfikacja	Nr materiałowy
3,00	4	125	91	87	32	29	SCD171-0300-2-4-135HA25-HP285	30392248
3,50	4	140	106	101	32	29	SCD171-0350-2-4-135HA25-HP285	30392249
4,00	4	140	106	100	32	25	SCD171-0400-2-4-135HA25-HP285	30392250
5,00	5	170	134	127	34	25	SCD171-0500-2-4-135HA25-HP285	30392252
5,50	6	185	147	139	36	25	SCD171-0550-2-4-135HA25-HP285	30392253
6,00	6	200	160	151	36	25	SCD171-0600-2-4-135HA25-HP285	30392254
7,00	7	225	185	175	38	25	SCD171-0700-2-4-135HA25-HP285	30392255
8,00	8	255	213	201	40	25	SCD171-0800-2-4-135HA25-HP285	30392256
9,00	9	280	238	225	40	25	SCD171-0900-2-4-135HA25-HP285	30392257
10,00	10	310	268	253	40	25	SCD171-1000-2-4-135HA25-HP285	30392258
11,00	11	340	293	277	45	25	SCD171-1100-2-4-135HA25-HP245	30392259
12,00	12	365	318	300	45	25	SCD171-1200-2-4-135HA25-HP245	30392260
14,00	14	425	373	352	50	25	SCD171-1400-2-4-135HA25-HP245	30392262

Zalecenie dla wiertła pilotującego:

Jako wiertła pilotującego należy użyć wiertła MEGA-Drill-Steel-Plus (SCD601 – 3xD) o takiej samej średnicy znamionowej.

Kąt wierzchołkowy i tolerancja średnicy wiertła pilotującego i wiertła do głębokiego wiercenia zostały odpowiednio dopasowane, aby zagwarantować ich optymalną funkcjonalność i współdziałanie.

Informacje techniczne dotyczące wiercenia głębokich otworów zamieszczono w rozdziale zatytułowanym „Aneks techniczny”.

Wymiary podano w mm.

Zalecane parametry skrawania – patrz koniec rozdziału.

Wersje specjalne i inne powłoki wg zapytania ofertowego.

MEGA-Deep-Drill

Wiertła spiralne z węgla spiekane
SCD171 (30xD), wewnętrzne doprowadzenie chłodziwa

Wersja:

Średnica wiertła: 3,00 – 12,00 mm
Tolerancja otworu: \geq IT 9
Materiał skrawający: HP245 / HP285
Liczba ostrzy: 2
Liczba łysinek: 4
Kąt wierzchołkowy: 135°
Kąt spirali: 30°

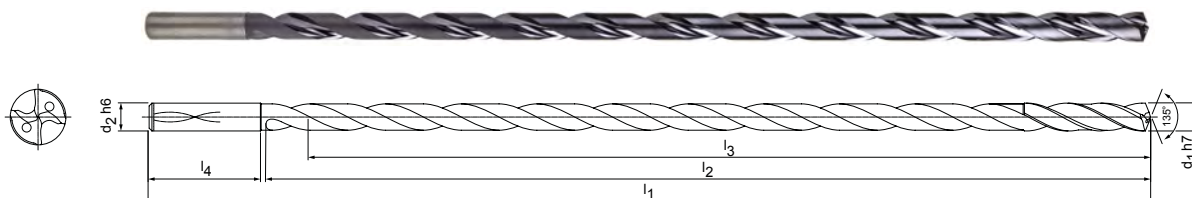

Magazynowa seria preferowana z typem chwytu HA

Wymiary						Stosunek L/d	Typ chwytu HA	
d ₁ h7	d ₂ h6	l ₁	l ₂	l ₃	l ₄		Specyfikacja	Nr materiałowy
3,00	4	145	110	106	32	35	SCD171-0300-2-4-135HA30-HP285	30392264
4,00	4	160	126	120	32	30	SCD171-0400-2-4-135HA30-HP285	30392266
4,50	5	180	144	137	34	31	SCD171-0450-2-4-135HA30-HP285	30392267
5,00	5	195	159	152	34	30	SCD171-0500-2-4-135HA30-HP285	30392268
5,50	6	210	172	164	36	30	SCD171-0550-2-4-135HA30-HP285	30392269
6,00	6	230	192	183	36	31	SCD171-0600-2-4-135HA30-HP285	30392270
7,00	7	260	220	210	38	30	SCD171-0700-2-4-135HA30-HP285	30392271
8,00	8	295	253	241	40	30	SCD171-0800-2-4-135HA30-HP285	30392272
9,00	9	325	283	270	40	30	SCD171-0900-2-4-135HA30-HP285	30392273
10,00	10	360	318	303	40	30	SCD171-1000-2-4-135HA30-HP285	30392274
11,00	11	400	353	337	45	31	SCD171-1100-2-4-135HA30-HP245	30392275
12,00	12	430	383	365	45	30	SCD171-1200-2-4-135HA30-HP245	30392276

Zalecenie dla wiertła pilotującego:

Jako wiertła pilotującego należy użyć wiertła MEGA-Drill-Steel-Plus (SCD601 – 3xD) o takiej samej średnicy znamionowej.

Kąt wierzchołkowy i tolerancja średnicy wiertła pilotującego i wiertła do głębokiego wiercenia zostały odpowiednio dopasowane, aby zagwarantować ich optymalną funkcjonalność i współdziałanie.

Informacje techniczne dotyczące wiercenia głębokich otworów zamieszczono w rozdziale zatytułowanym „Aneks techniczny”.

Wymiary podano w mm.

Zalecane parametry skrawania – patrz koniec rozdziału.

Wersje specjalne i inne powłoki wg zapytania ofertowego.

MEGA-Deep-Drill

Wiertła spiralne z węgla spiekanego
SCD171 (40xD), wewnętrzne doprowadzenie chłodziwa

Wersja:

Średnica wiertła:	4,00 – 6,00 mm
Tolerancja otworu:	≥ IT 9
Materiał skrawający:	HP285
Liczba ostrzy:	2
Liczba łysinek:	4
Kąt wierzchołkowy:	130°
Kąt spirali:	30°

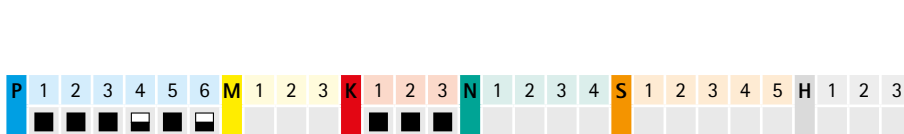
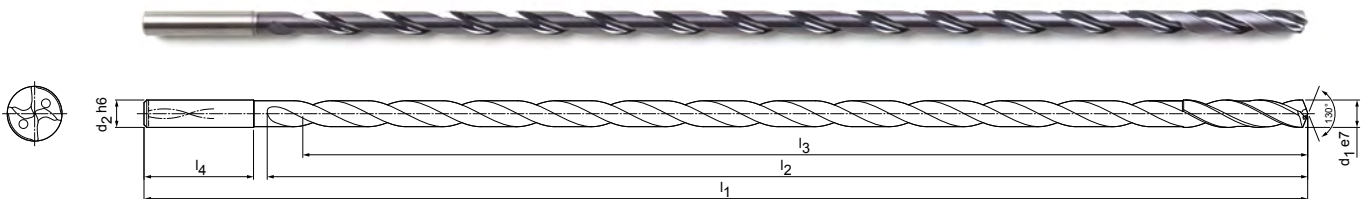

Magazynowa seria preferowana z typem chwytu HA

Wymiary						Stosunek L/d	Typ chwytu HA	
d ₁ e7	d ₂ h6	l ₁	l ₂	l ₃	l ₄		Specyfikacja	Nr materiałowy
4,00	4	205	170	164	32	43	SCD171-0400-2-4-130HA40-HP285	30549867
5,00	5	245	208	201	34	42	SCD171-0500-2-4-130HA40-HP285	30549869
6,00	6	290	250	241	36	42	SCD171-0600-2-4-130HA40-HP285	30549871

Zalecenie dla wiertła pilotującego lub wstępnego wiercenia:

Jako wiertła pilotującego należy użyć wiertła MEGA-Drill-Steel-Plus (SCD601 – 3xD) o takiej samej średnicy znamionowej. Następnie nawiercić wstępnie za pomocą MEGA-Deep-Drill (SCD171 – 20xD) i identycznej średnicy znamionowej. Kąt wierzchołkowy i tolerancja średnicy wiertła pilotującego i wiertła do głębokiego wiercenia zostały odpowiednio dopasowane, aby zagwarantować ich optymalną funkcjonalność i współdziałanie.

Informacje techniczne dotyczące wiercenia głębokich otworów zamieszczono w rozdziale zatytułowanym „Aneks techniczny”.

Wymiary podano w mm.

Zalecane parametry skrawania – patrz koniec rozdziału.

Wersje specjalne i inne powłoki wg zapytania ofertowego.

MEGA-Deep-Drill-Alu

Wiertła spiralne z węgla spiekanego
SCD181 (15xD), wewnętrzne doprowadzenie chłodziwa

Wersja:

Średnica wiertła:	3,00 – 12,00 mm
Tolerancja otworu:	≥ IT 9
Materiał skrawający:	HU680 / HU644
Liczba ostrzy:	2
Liczba tyśinek:	4
Kąt wierzchołkowy:	135°
Kąt spirali:	30°

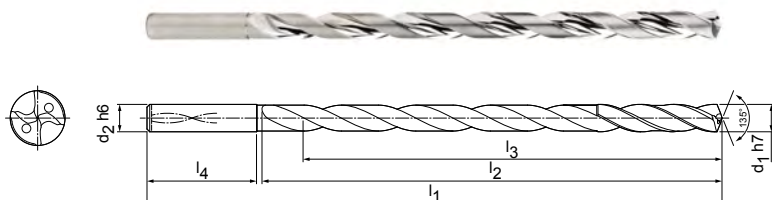

Magazynowa seria preferowana z typem chwytu HA

Wymiary						Stosunek L/d	Typ chwytu HA	
d ₁ h7	d ₂ h6	l ₁	l ₂	l ₃	l ₄		Specyfikacja	Nr materiałowy
3,00	4	90	56	52	32	17	SCD181-0300-2-4-135HA15-HU680	30392277
3,50	4	100	66	61	32	17	SCD181-0350-2-4-135HA15-HU680	30392278
4,00	4	100	66	60	32	15	SCD181-0400-2-4-135HA15-HU680	30392279
5,00	5	120	84	77	34	15	SCD181-0500-2-4-135HA15-HU680	30392281
6,00	6	140	102	93	36	16	SCD181-0600-2-4-135HA15-HU680	30392283
7,00	7	155	115	105	38	15	SCD181-0700-2-4-135HA15-HU680	30392284
8,00	8	175	133	121	40	15	SCD181-0800-2-4-135HA15-HU680	30392285
10,00	10	210	168	153	40	15	SCD181-1000-2-4-135HA15-HU680	30392287
12,00	12	250	203	185	45	15	SCD181-1200-2-4-135HA15-HU644	30392289

Zalecenie dla wiertła pilotującego:

Jako wiertła pilotującego należy użyć wiertła MEGA-Drill-Alu (SCD131 – 3xD/5xD) o takiej samej średnicy znamionowej.

Kąt wierzchołkowy i tolerancja średnicy wiertła pilotującego i wiertła do głębokiego wiercenia zostały odpowiednio dopasowane, aby zagwarantować ich optymalną funkcjonalność i współdziałanie.

Informacje techniczne dotyczące wiercenia głębokich otworów zamieszczono w rozdziale zatytułowanym „Aneks techniczny”.

Wymiary podano w mm.

Zalecane parametry skrawania – patrz koniec rozdziału.

Wersje specjalne i inne powłoki wg zapytania ofertowego.

MEGA-Deep-Drill-Alu

Wiertła spiralne z węgla spiekanego
SCD181 (20xD), wewnętrzne doprowadzenie chłodziwa

Wersja:

Średnica wiertła:	3,00 – 12,00 mm
Tolerancja otworu:	≥ IT 9
Materiał skrawający:	HU680 / HU644
Liczba ostrzy:	2
Liczba tyśinek:	4
Kąt wierzchołkowy:	135°
Kąt spirali:	30°

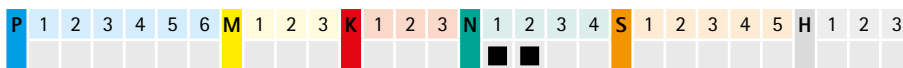
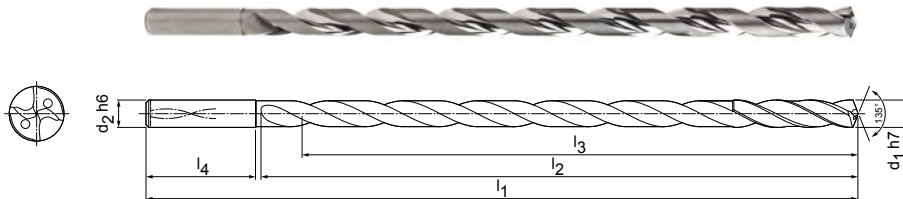

Magazynowa seria preferowana z typem chwytu HA

Wymiary						Stosunek L/d	Typ chwytu HA	
d ₁ h7	d ₂ h6	l ₁	l ₂	l ₃	l ₄		Specyfikacja	Nr materiałowy
3,00	4	110	74	70	32	23	SCD181-0300-2-4-135HA20-HU680	30392294
4,00	4	120	86	80	32	20	SCD181-0400-2-4-135HA20-HU680	30392296
5,00	5	145	109	102	34	20	SCD181-0500-2-4-135HA20-HU680	30392298
5,50	6	160	120	112	36	20	SCD181-0550-2-4-135HA20-HU680	30392299
6,00	6	170	130	121	36	20	SCD181-0600-2-4-135HA20-HU680	30392300
7,00	7	190	150	140	38	20	SCD181-0700-2-4-135HA20-HU680	30392301
8,00	8	215	173	161	40	20	SCD181-0800-2-4-135HA20-HU680	30392302
10,00	10	260	218	203	40	20	SCD181-1000-2-4-135HA20-HU680	30392304
12,00	12	305	258	240	45	20	SCD181-1200-2-4-135HA20-HU644	30392306

Zalecenie dla wiertła pilotującego:

Jako wiertła pilotującego należy użyć wiertła MEGA-Drill-Alu (SCD131 – 3xD/5xD) o takiej samej średnicy znamionowej.

Kąt wierzchołkowy i tolerancja średnicy wiertła pilotującego i wiertła do głębokiego wiercenia zostały odpowiednio dopasowane, aby zagwarantować ich optymalną funkcjonalność i współdziałanie.

Informacje techniczne dotyczące wiercenia głębokich otworów zamieszczono w rozdziale zatytułowanym „Aneks techniczny”.

Wymiary podano w mm.

Zalecane parametry skrawania – patrz koniec rozdziału.

Wersje specjalne i inne powłoki wg zapytania ofertowego.

MEGA-Deep-Drill-Alu

Wiertła spiralne z węgliku spiekanego
SCD181 (25xD), wewnętrzne doprowadzenie chłodziwa

Wersja:

Średnica wiertła:	3,00 – 10,00 mm
Tolerancja otworu:	≥ IT 9
Materiał skrawający:	HU680
Liczba ostrzy:	2
Liczba łysinek:	4
Kąt wierzchołkowy:	135°
Kąt spirali:	30°

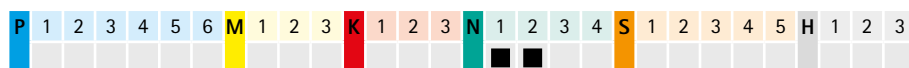
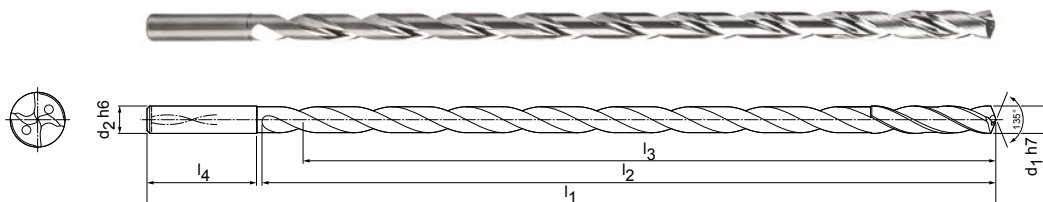

Magazynowa seria preferowana z typem chwytu HA

Wymiary						Stosunek L/d	Typ chwytu HA	
d ₁ h7	d ₂ h6	l ₁	l ₂	l ₃	l ₄		Specyfikacja	Nr materiałowy
3,00	4	125	91	87	32	29	SCD181-0300-2-4-135HA25-HU680	30392311
4,00	4	140	106	100	32	25	SCD181-0400-2-4-135HA25-HU680	30392313
5,00	5	170	134	127	34	25	SCD181-0500-2-4-135HA25-HU680	30392315
6,00	6	200	160	151	36	25	SCD181-0600-2-4-135HA25-HU680	30392317
7,00	7	225	185	175	38	25	SCD181-0700-2-4-135HA25-HU680	30392318
8,00	8	255	213	201	40	25	SCD181-0800-2-4-135HA25-HU680	30392319
10,00	10	310	268	253	40	25	SCD181-1000-2-4-135HA25-HU680	30392321

Zalecenie dla wiertła pilotującego:

Jako wiertła pilotującego należy użyć wiertła MEGA-Drill-Alu (SCD131 – 3xD/5xD) o takiej samej średnicy znamionowej.

Kąt wierzchołkowy i tolerancja średnicy wiertła pilotującego i wiertła do głębokiego wiercenia zostały odpowiednio dopasowane, aby zagwarantować ich optymalną funkcjonalność i współdziałanie.

Informacje techniczne dotyczące wiercenia głębokich otworów zamieszczono w rozdziale zatytułowanym „Aneks techniczny”.

Wymiary podano w mm.

Zalecane parametry skrawania – patrz koniec rozdziału.

Wersje specjalne i inne powłoki wg zapytania ofertowego.

MEGA-Deep-Drill-Alu

Wiertła spiralne z węgla spiekanego
SCD181 (30xD), wewnętrzne doprowadzenie chłodziwa

Wersja:

Średnica wiertła:	4,00 - 6,00 mm
Tolerancja otworu:	≥ IT 9
Materiał skrawający:	HU680
Liczba ostrzy:	2
Liczba łysinek:	4
Kąt wierzchołkowy:	135°
Kąt spirali:	30°

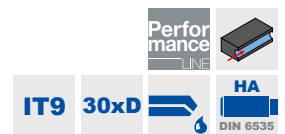
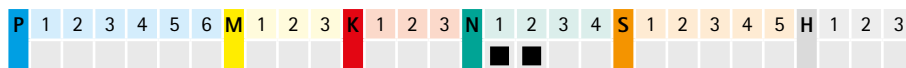
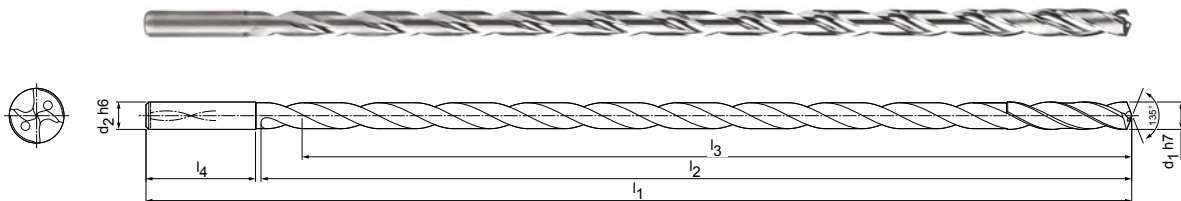

Magazynowa seria preferowana z typem chwytu HA

Wymiary						Stosunek L/d	Typ chwytu HA	
d ₁ h7	d ₂ h6	l ₁	l ₂	l ₃	l ₄		Specyfikacja	Nr materiałowy
4,00	4	160	126	120	32	30	SCD181-0400-2-4-135HA30-HU680	30392328
4,50	5	180	144	137	34	31	SCD181-0450-2-4-135HA30-HU680	30392329
5,00	5	195	159	152	34	30	SCD181-0500-2-4-135HA30-HU680	30392330
6,00	6	230	192	183	36	31	SCD181-0600-2-4-135HA30-HU680	30392332

Zalecenie dla wiertła pilotującego:

Jako wiertła pilotującego należy użyć wiertła MEGA-Drill-Alu (SCD131 – 3xD/5xD) o takiej samej średnicy znamionowej.

Kąt wierzchołkowy i tolerancja średnicy wiertła pilotującego i wiertła do głębokiego wiercenia zostały odpowiednio dopasowane, aby zagwarantować ich optymalną funkcjonalność i współdziałanie.

Informacje techniczne dotyczące wiercenia głębokich otworów zamieszczono w rozdziale zatytułowanym „Aneks techniczny”.

Wymiary podano w mm.

Zalecane parametry skrawania – patrz koniec rozdziału.

Wersje specjalne i inne powłoki wg zapytania ofertowego.

MEGA-Deep-Drill-Alu

Wiertła spiralne z węgliku spiekanego
SCD181 (40xD), wewnętrzne doprowadzenie chłodziwa

Wersja:

Średnica wiertła:	6,00 - 7,00 mm
Tolerancja otworu:	≥ IT 9
Materiał skrawający:	HU680
Liczba ostrzy:	2
Liczba łysinek:	4
Kąt wierzchołkowy:	130°
Kąt spirali:	30°

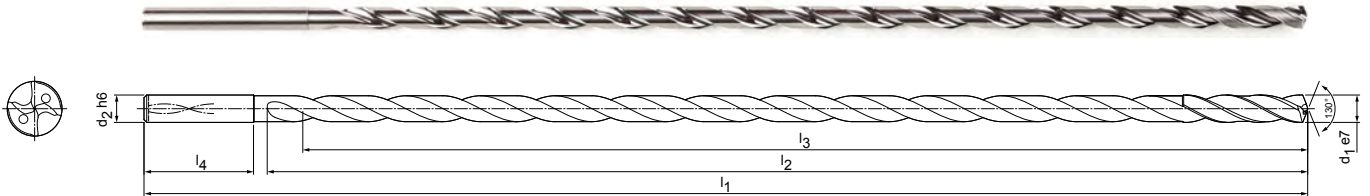

Magazynowa seria preferowana z typem chwytu HA

Wymiary						Stosunek L/d	Typ chwytu HA	
d ₁ h7	d ₂ h6	l ₁	l ₂	l ₃	l ₄		Specyfikacja	Nr materiałowy
6,00	6	290	250	241	36	42	SCD181-0600-2-4-130HA40-HU680	30549881
7,00	7	330	290	280	38	41	SCD181-0700-2-4-130HA40-HU680	30549882

Zalecenie dla wiertła pilotującego:

Jako wiertła pilotującego należy użyć wiertła MEGA-Drill-Alu (SCD131 – 3xD/5xD) o takiej samej średnicy znamionowej.

Kąt wierzchołkowy i tolerancja średnicy wiertła pilotującego i wiertła do głębokiego wiercenia zostały odpowiednio dopasowane, aby zagwarantować ich optymalną funkcjonalność i współdziałanie.

Informacje techniczne dotyczące wiercenia głębokich otworów zamieszczono w rozdziale zatytułowanym „Aneks techniczny”.

Wymiary podano w mm.

Zalecane parametry skrawania – patrz koniec rozdziału.

Wersje specjalne i inne powłoki wg zapytania ofertowego.



Zalecane parametry skrawania dla wiertel do głębokiego wiercenia

Posuw i prędkość skrawania

MEGA-Pilot-Drill | SCD581

MZG*		Materiał obrabiany	Wytrzymałość/twardość [N/mm ²] [HRC]
P	P1	P1.1 Stale konstrukcyjne, użytkowe i uszlachetnione, stale niestopowe	< 700
		P1.2 Stale konstrukcyjne, użytkowe i uszlachetnione, stale niestopowe	< 1 200
	P2	P2.1 Stale azotowane, użytkowe i uszlachetnione, stale stopowe	< 900
		P2.2 Stale azotowane, użytkowe i uszlachetnione, stale stopowe	< 1 400
	P3	P3.1 Stale narzędziowe, łożyskowe, sprężynowe i stale szybko tnące**	< 800
		P3.2 Stale narzędziowe, łożyskowe, sprężynowe i stale szybko tnące**	< 1 000
		P3.3 Stale narzędziowe, łożyskowe, sprężynowe i stale szybko tnące**	< 1 500
	P5	P5.1 Staliwo	
M	M1	M1.1 Stale nierdzewne, austenityczne	< 700
		M1.2 Stale nierdzewne, ferrytyczne/austenityczne (Duplex)	< 1 000
K	K1	K1.1 Żeliwo z grafitem płatkowym (żeliwo szare), GJL	< 300
		K2.1 Żeliwo sferoidalne, GJS	< 500
	K2	K2.2 Żeliwo sferoidalne, GJS	≤ 800
		K2.3 Żeliwo sferoidalne, GJS	> 800
	K3	K3.1 Żeliwo wermikularne, GJV, (żeliwo ciągliwe), GJL	< 500
		K3.2 Żeliwo wermikularne, GJV, (żeliwo ciągliwe), GJL	> 500

* Grupa materiałowa wg MAPAL

** Jeśli składniki stopu Cr, Mo, Ni, V, W wynoszą łącznie > 8%, należy wybrać następną w kolejności grupę materiałową MAPAL.

	Prędkość skrawania v_c [m/min]				Posuw f [mm] przy średnicy wiertła					
	Chłodzenie wewnętrzne	Chłodzenie zewnętrzne	Mgietka	Powietrze	1,00	1,20	1,60	1,90	2,40	3,00
	80	70	70		0,05	0,06	0,06	0,07	0,08	0,09
	70	60	60		0,07	0,07	0,08	0,09	0,10	0,11
	80	70	70		0,06	0,07	0,08	0,08	0,10	0,11
	55	50	50		0,06	0,06	0,07	0,07	0,08	0,09
	60	50	50		0,06	0,06	0,07	0,07	0,08	0,10
	50	45	45		0,05	0,05	0,06	0,07	0,07	0,08
	50	35	40		0,05	0,05	0,05	0,06	0,06	0,07
	80	70	70		0,06	0,07	0,08	0,08	0,10	0,11
	45	30	30		0,04	0,04	0,05	0,05	0,06	0,06
	95	70	70	70	0,06	0,07	0,08	0,09	0,10	0,12
	130	80	95	95	0,07	0,07	0,08	0,09	0,11	0,13
	80	60	60		0,06	0,07	0,08	0,09	0,10	0,11
	70	65	65		0,07	0,08	0,08	0,09	0,11	0,12
	65	55	55		0,06	0,07	0,08	0,08	0,09	0,11

Podane parametry skrawania to wartości orientacyjne.

Optymalne wartości dla danego przypadku obróbki należy ustalić w ramach próby lub podczas obróbki.

Zalecane parametry skrawania dla wiertel do głębokiego wiercenia

Posuw i prędkość skrawania

MEGA-Deep-Drill | SCD171

MZG*		Materiał obrabiany	Wytrzymałość/twardość [N/mm ²] [HRC]
P	P1	P1.1 Stale konstrukcyjne, użytkowe i uszlachetnione, stale niestopowe	< 700
		P1.2 Stale konstrukcyjne, użytkowe i uszlachetnione, stale niestopowe	< 1 200
	P2	P2.1 Stale azotowane, użytkowe i uszlachetnione, stale stopowe	< 900
		P2.2 Stale azotowane, użytkowe i uszlachetnione, stale stopowe	< 1 400
	P3	P3.1 Stale narzędziowe, łożyskowe, sprężynowe i stale szybko tnące**	< 800
		P3.2 Stale narzędziowe, łożyskowe, sprężynowe i stale szybko tnące**	< 1 000
		P3.3 Stale narzędziowe, łożyskowe, sprężynowe i stale szybko tnące**	< 1 500
	P5	P5.1 Staliwo	
K	K1	K1.1 Żeliwo z grafitem płatkowym (żeliwo szare), GJL	< 300
		K2.1 Żeliwo sferoidalne, GJS	< 500
	K2	K2.2 Żeliwo sferoidalne, GJS	≤ 800
		K2.3 Żeliwo sferoidalne, GJS	> 800
	K3	K3.1 Żeliwo wermikularne, GJV, (żeliwo ciągliwe), GJL	< 500
		K3.2 Żeliwo wermikularne, GJV, (żeliwo ciągliwe), GJL	> 500

MEGA-Deep-Drill-Alu | SCD181

MZG*		Materiał obrabiany	Wytrzymałość/twardość [N/mm ²] [HRC]
N	N1	N1.1 Aluminium, niestopowe i stopowe < 3 % Si	
		N1.2 Aluminium, stopowe ≤ 7 % Si	
		N1.3 Aluminium, stopowe > 7-12 % Si	
		N1.4 Aluminium, stopowe > 12 % Si	
	N2	N2.1 Miedź, niestopowa i niskostopowa	< 300
		N2.2 Miedź, stopowa	> 300
		N2.3 Mosiądz, brąz, spiż	< 1 200

* Grupa materiałowa wg MAPAL

** Jeśli składniki stopu Cr, Mo, Ni, V, W wynoszą łącznie > 8%, należy wybrać następną w kolejności grupę materiałową MAPAL.

	Prędkość skrawania v_c [m/min]			Posuw f [mm] przy średnicy wiertła					
	Chłodzenie wewnętrzne	Mgiewka	Powietrze	1,00	2,00	4,00	6,00	9,00	16,00
	90	80		0,04	0,06	0,09	0,13	0,19	0,27
	80	70		0,06	0,08	0,11	0,16	0,24	0,34
	90	75		0,05	0,07	0,10	0,16	0,23	0,32
	65	55		0,05	0,07	0,09	0,13	0,18	0,25
	70	60		0,05	0,06	0,09	0,14	0,21	0,29
	55	50		0,04	0,06	0,08	0,12	0,17	0,23
	55	45		0,04	0,05	0,07	0,09	0,13	0,18
	90	75		0,05	0,07	0,10	0,16	0,23	0,32
	110	75	75	0,14	0,18	0,25	0,32	0,41	0,53
	145	110	110	0,14	0,18	0,24	0,30	0,38	0,49
	90	70		0,13	0,16	0,21	0,26	0,33	0,42
	55	45		0,10	0,12	0,14	0,18	0,22	0,28
	80	70		0,14	0,18	0,22	0,28	0,36	0,46
	70	65		0,12	0,15	0,18	0,23	0,29	0,36

	Prędkość skrawania v_c [m/min]			Posuw f [mm] przy średnicy wiertła					
	Chłodzenie wewnętrzne	Mgiewka	Powietrze	3,00	4,00	5,50	7,50	10,50	16,00
	300	250		0,11	0,13	0,16	0,20	0,25	0,32
	250	200		0,13	0,16	0,21	0,26	0,33	0,42
	220	180		0,13	0,16	0,21	0,26	0,33	0,42
	180	150		0,13	0,16	0,21	0,26	0,33	0,42
	140			0,09	0,11	0,14	0,17	0,21	0,27
	120			0,11	0,14	0,17	0,22	0,28	0,35
	200	160	120	0,14	0,18	0,25	0,32	0,41	0,53

Podane parametry skrawania to wartości orientacyjne.

Optymalne wartości dla danego przypadku obróbki należy ustalić w ramach próby lub podczas obróbki.



WIERCENIE I ROZWIERCANIE W JEDNYM KROKU ROBOCZYM

Wiertło-rozwiertaki

Technologia 290

Tritan-Drill-Reamer 292

Aneks techniczny

Zalecane parametry skrawania 298

TRITAN-DRILL-REAMER

Najbardziej precyzyjne rozwiązanie do wiercenia i rozwierania w jednym kroku roboczym

Sprawdzoną metodą poprawy opłacalności wytwarzania jest połączenie kilku etapów obróbki w jednym narzędziu. Na przykład za pomocą rozwiertaka Tritan-Drill-Reamer firmy MAPAL można jednocześnie wiercić i rozwierać otwory.

Aby umożliwić jeszcze dokładniejsze wykonanie otworów montażowych za pomocą jednego narzędzia, firma MAPAL opracowała rozwiertak Tritan-Drill-Reamer.

Oczywiste zalety nowego narzędzia Tritan-Drill-Reamer to: sześć łysinek dla doskonałego prowadzenia, precyzyjnie szlifowane rowki wiórowe o kształcie zoptymalizowanym pod kątem skutecznego usuwania wiórów i samocentrujący ścin.

Samocentrujący ścin zapewnia dobrą dokładność pozycji narzędzia i poprawia jego właściwości eksploatacyjne podczas nawiercania. Trzy ostrza gwarantują optymalną okrągłość otworu montażowego i maksymalną wydajność. Łysinki pozwalają na uzyskanie najwyższej jakości powierzchni.

CECHY

- Połączenie wiercenia i rozwierania
- Wersja długości 3xD i 5xD
- Trzy ostrza i sześć łysinek
- Z chłodzeniem wewnętrznym
- Wersje z tolerancją $\pm 0,003$ mm i H7

ZALETY

- Redukcja czasu obróbki i czasu cyklu
- Najlepsze osiągi i najwyższa dokładność
- Wysoka dokładność pozycji narzędzia
- Optymalna okrągłość

Cechy charakterystyczne narzędzia

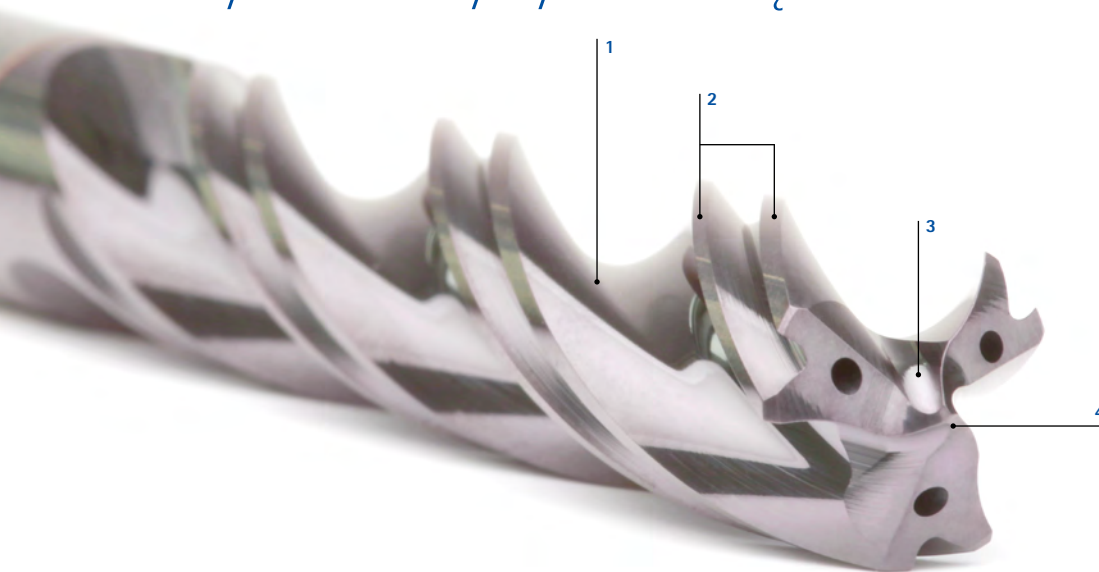

1 Precyzyjnie szlifowany rowek wiórowy

2 Sześć łysinek

3 Innowacyjna geometria czoła

4 Samocentrujący ścin



Sześć łysinek

- Doskonałe prowadzenie narzędzia
- Wykonywanie otworów montażowych z maksymalną oszczędnością i dokładnością przy użyciu jednego narzędzia



Innowacyjna geometria czoła

- Samocentrujący ścin zapewnia dobrą dokładność pozycji i lepsze prowadzenie narzędzia podczas nawiercania



Precyzyjnie szlifowany rowek wiórowy

- Precyzyjnie szlifowane rowki wiórowe o kształcie zoptymalizowanym pod kątem skutecznego usuwania wiórów



Porównanie rozwiertaka Tritan-Drill-Reamer z narzędziem dwuostrzowym

Durchmesserabweichung vom gemessenen Werkzeugdurchmesser (42CrMoS4)

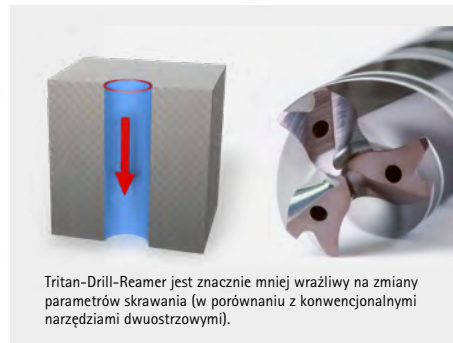
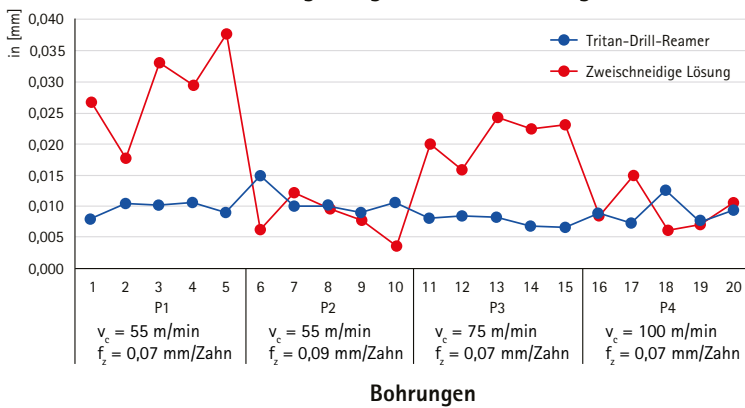

Rundheit über 600 Bohrungen

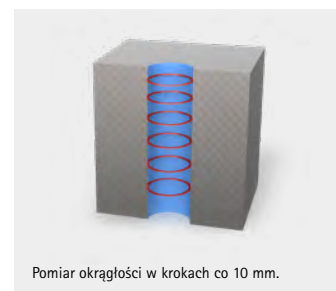
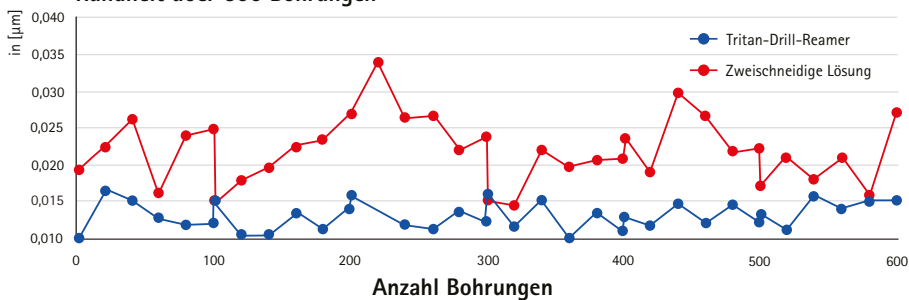

Tritan-Drill-Reamer

Wiertło-rozwiertak

SDR301G (3xD), wewnętrzne doprowadzenie chłodziwa

Wersja:

Średnica wiertła:	3,80 – 20,05 mm
Tolerancja otworu:	≥ IT 7
Materiał skrawający:	HP358
Liczba ostrzy:	3
Liczba łysinek:	6
Kąt wierzchołkowy:	140°
Kąt spirali:	30°

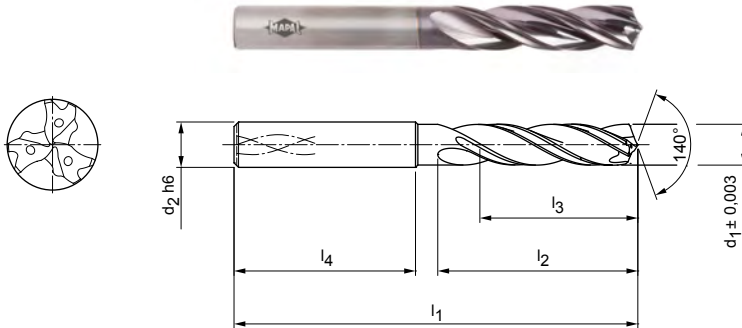

Magazynowa seria preferowana z typem chwytu HA

Wymiary						Typ chwytu HA	
$d_1 \pm 0,003$	$d_2 h6$	l_1	l_2	l_3	l_4	Specyfikacja	Nr materiałowy
3,99	6	66	24	17	36	SDR301G-3.990+3-3-HA03-HP358	31196569
4,00	6	66	24	17	36	SDR301G-4.000+3-3-HA03-HP358	31196570
4,01	6	66	24	17	36	SDR301G-4.010+3-3-HA03-HP358	31196571
4,99	6	66	28	20	36	SDR301G-4.990+3-3-HA03-HP358	31196575
5,00	6	66	28	20	36	SDR301G-5.000+3-3-HA03-HP358	31196576
5,01	6	66	28	20	36	SDR301G-5.010+3-3-HA03-HP358	31196577
5,02	6	66	28	20	36	SDR301G-5.020+3-3-HA03-HP358	31196578
5,99	6	66	28	20	36	SDR301G-5.990+3-3-HA03-HP358	31196581
6,00	6	66	28	20	36	SDR301G-6.000+3-3-HA03-HP358	31196582
6,01	6	66	28	20	36	SDR301G-6.010+3-3-HA03-HP358	31196583
7,99	8	79	41	29	36	SDR301G-7.990+3-3-HA03-HP358	31196587
8,00	8	79	41	29	36	SDR301G-8.000+3-3-HA03-HP358	31196588
8,01	8	79	41	29	36	SDR301G-8.010+3-3-HA03-HP358	31196589
9,99	10	89	47	35	40	SDR301G-9.990+3-3-HA03-HP358	31196593
10,00	10	89	47	35	40	SDR301G-10.000+3-3-HA03-HP358	31196594
10,01	10	89	47	35	40	SDR301G-10.010+3-3-HA03-HP358	31196595
10,02	10	89	47	35	40	SDR301G-10.020+3-3-HA03-HP358	31196596
11,99	12	102	55	40	45	SDR301G-11.990+3-3-HA03-HP358	31196599
12,00	12	102	55	40	45	SDR301G-12.000+3-3-HA03-HP358	31196600
12,01	12	102	55	40	45	SDR301G-12.010+3-3-HA03-HP358	31196601
13,99	14	107	60	43	45	SDR301G-13.990+3-3-HA03-HP358	31196605
14,00	14	107	60	43	45	SDR301G-14.000+3-3-HA03-HP358	31196606
14,01	14	107	60	43	45	SDR301G-14.010+3-3-HA03-HP358	31196607
15,99	16	115	65	45	48	SDR301G-15.990+3-3-HA03-HP358	31196611
16,00	16	115	65	45	48	SDR301G-16.000+3-3-HA03-HP358	31196612
16,01	16	115	65	45	48	SDR301G-16.010+3-3-HA03-HP358	31196613

Tritan-Drill-Reamer | Wiertło-rozwiertak SDR301G (3xD), wewnętrzne doprowadzenie chłodziwa

Możliwość konfiguracji parametrów



Średnica:
Możliwość wyboru średnicy w krokach
co 0,001 mm

Specyfikacja:
SDR301G-[średnica]+3-3-HA03-HP358

Przykład:

SDR301G-4.001+3-3-HA03-HP358

Średnica narzędzia $d_1 = 4,001$ mm

Wymiary typoszeregu z możliwością konfiguracji parametrów

d_1 min.	d_1 maks.	d_2 h6	l_1	l_2	l_3	l_4
3,800	4,700	6	66	24	17	36
4,701	6,050	6	66	28	20	36
6,051	8,050	8	79	41	29	36
8,051	10,050	10	89	47	35	40
10,051	12,050	12	102	55	40	45
12,970	14,050	14	107	60	43	45
14,970	16,050	16	115	65	45	48
16,800	18,050	18	123	73	51	48
18,700	20,050	20	131	79	55	50

Wymiary podano w mm.

Do wykonywania otworów montażowych o klasach tolerancji do maks. IT7, przy wystarczającej stabilności maszyny i chłodzeniu.

Pomoc w obliczeniu optymalnej średnicy znamionowej dla różnych otworów montażowych znajduje się w ramce informacyjnej na końcu rozdziału.

Zalecane parametry skrawania - patrz koniec rozdziału.

Wersje specjalne i inne powłoki wg zapytania ofertowego.

Tritan-Drill-Reamer

Wiertło-rozwiertak

SDR301 (3xD), wewnętrzne doprowadzenie chłodziwa

Wersja:

Średnica wiertła: 4,00 – 16,00 mm

Tolerancja otworu: \geq IT 7

Materiał skrawający: HP358

Liczba ostrzy: 3

Liczba łysinek: 6

Kąt wierzchołkowy: 140°

Kąt spirali: 30°

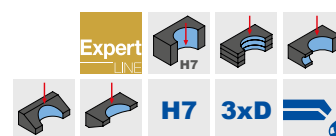
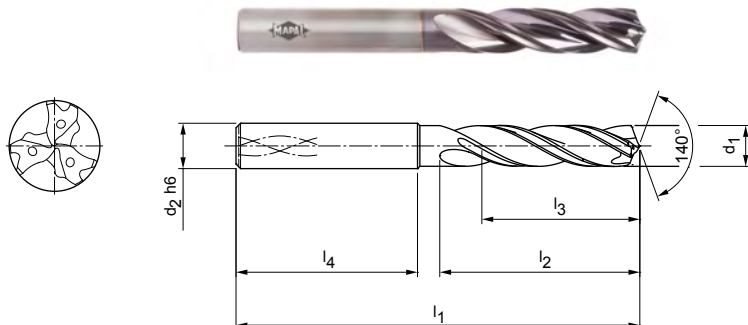

Magazynowa seria preferowana z typem chwytu HA

Wymiary						Typ chwytu HA	
d ₁ H7	d ₂ h6	l ₁	l ₂	l ₃	l ₄	Specyfikacja	Nr materiałowy
4,00	6	66	24	17	36	SDR301-4.000H7-HA03-HP358	31196337
5,00	6	66	28	20	36	SDR301-5.000H7-HA03-HP358	31196338
6,00	6	66	28	20	36	SDR301-6.000H7-HA03-HP358	31196339
8,00	8	79	41	29	36	SDR301-8.000H7-HA03-HP358	31196560
10,00	10	89	47	35	40	SDR301-10.000H7-HA03-HP358	31196561
12,00	12	102	55	40	45	SDR301-12.000H7-HA03-HP358	31196562
14,00	14	107	60	43	45	SDR301-14.000H7-HA03-HP358	31196563
16,00	16	115	65	45	48	SDR301-16.000H7-HA03-HP358	31196564

Wymiary podano w mm.

Do wykonywania otworów montażowych o klasie tolerancji H7, przy wystarczającej stabilności maszyny i chłodzeniu.

Zalecane parametry skrawania - patrz koniec rozdziału.

Wersje specjalne i inne powłoki wg zapytania ofertowego.

Tritan-Drill-Reamer

Wiertło-rozwiertak

SDR301G (5xD), wewnętrzne doprowadzenie chłodziwa

Wersja:

Średnica wiertła: 3,80 – 20,05 mm
 Tolerancja otworu: \geq IT 7
 Materiał skrawający: HP358
 Liczba ostrzy: 3
 Liczba łysinek: 6
 Kąt wierchołkowy: 140°
 Kąt spirali: 30°

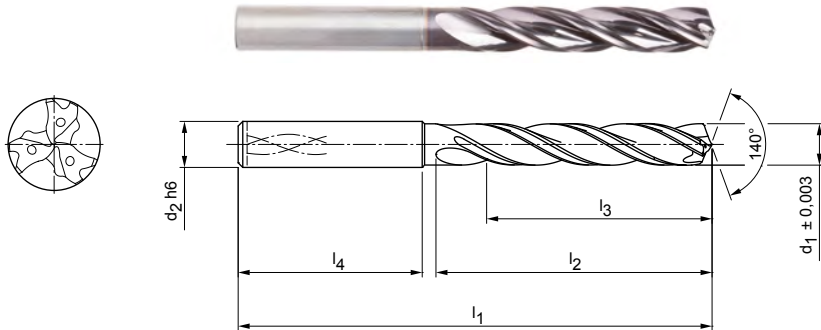

Magazynowa seria preferowana z typem chwytu HA

Wymiary						Typ chwytu HA	
d ₁ +/-0,003	d ₂ h6	l ₁	l ₂	l ₃	l ₄	Specyfikacja	Nr materiałowy
3,99	6	74	36	29	36	SDR301G-3.990+3-3-HA05-HP358	31196639
4,00	6	74	36	29	36	SDR301G-4.000+3-3-HA05-HP358	31196640
4,01	6	74	36	29	36	SDR301G-4.010+3-3-HA05-HP358	31196641
4,02	6	74	36	29	36	SDR301G-4.020+3-3-HA05-HP358	31196642
4,99	6	82	44	35	36	SDR301G-4.990+3-3-HA05-HP358	31196645
5,00	6	82	44	35	36	SDR301G-5.000+3-3-HA05-HP358	31196646
5,01	6	82	44	35	36	SDR301G-5.010+3-3-HA05-HP358	31196647
5,99	6	82	44	35	36	SDR301G-5.990+3-3-HA05-HP358	31196651
6,00	6	82	44	35	36	SDR301G-6.000+3-3-HA05-HP358	31196652
6,01	6	82	44	35	36	SDR301G-6.010+3-3-HA05-HP358	31196653
7,99	8	91	53	43	36	SDR301G-7.990+3-3-HA05-HP358	31196658
8,00	8	91	53	43	36	SDR301G-8.000+3-3-HA05-HP358	31196659
8,01	8	91	53	43	36	SDR301G-8.010+3-3-HA05-HP358	31196660
8,02	8	91	53	43	36	SDR301G-8.020+3-3-HA05-HP358	31196661
9,99	10	103	61	49	40	SDR301G-9.990+3-3-HA05-HP358	31196664
10,00	10	103	61	49	40	SDR301G-10.000+3-3-HA05-HP358	31196665
10,01	10	103	61	49	40	SDR301G-10.010+3-3-HA05-HP358	31196666
11,99	12	118	71	59	45	SDR301G-11.990+3-3-HA05-HP358	31196670
12,00	12	118	71	59	45	SDR301G-12.000+3-3-HA05-HP358	31196671
12,01	12	118	71	59	45	SDR301G-12.010+3-3-HA05-HP358	31196672
13,99	14	124	77	60	45	SDR301G-13.990+3-3-HA05-HP358	31196676
14,00	14	124	77	60	45	SDR301G-14.000+3-3-HA05-HP358	31196677
14,01	14	124	77	60	45	SDR301G-14.010+3-3-HA05-HP358	31196678
15,99	16	133	83	63	48	SDR301G-15.990+3-3-HA05-HP358	31196682
16,00	16	133	83	63	48	SDR301G-16.000+3-3-HA05-HP358	31196683
16,01	16	133	83	63	48	SDR301G-16.010+3-3-HA05-HP358	31196684

ciąg dalszy na następnej stronie.

Tritan-Drill-Reamer | Wiertło-rozwiertak SDR301G (5xD), wewnętrzne doprowadzenie chłodziwa

Możliwość konfiguracji parametrów



Średnica:

Możliwość wyboru średnicy w krokach
co 0,001 mm



Specyfikacja:

SDR301G-[średnica]+3-3-HA05-HP358

Przykład:

SDR301G-04001+3-3-HA05-HP358

Średnica narzędzia $d_1 = 4,001$ mm

Wymiary typoszeregu z możliwością konfiguracji parametrów

d_1 min.	d_1 maks.	d_2 h6	l_1	l_2	l_3	l_4
3,800	4,700	6	74	36	29	36
4,701	6,050	6	82	44	35	36
6,051	8,050	8	91	53	43	36
8,051	10,050	10	103	61	49	40
10,051	12,050	12	118	71	56	45
12,970	14,050	14	124	77	60	45
14,970	16,050	16	133	83	63	48
16,800	18,050	18	143	93	71	48
18,700	20,050	20	153	101	77	50

Wymiary podano w mm.

Do wykonywania otworów montażowych o klasach tolerancji do maks. IT7, przy wystarczającej stabilności maszyny i chłodzeniu.

Pomoc w obliczeniu optymalnej średnicy znamionowej dla różnych otworów montażowych znajduje się w ramce informacyjnej na końcu rozdziału.

Zalecane parametry skrawania - patrz koniec rozdziału.

Wersje specjalne i inne powłoki wg zapytania ofertowego.

Tritan-Drill-Reamer

Wiertło-rozwiertak

SDR301 (5xD), wewnętrzne doprowadzenie chłodziwa

Wersja:

Średnica wiertła:	4,00 – 20,00 mm
Tolerancja otworu:	≥ IT 7
Materiał skrawający:	HP358
Liczba ostrzy:	3
Liczba łysinek:	6
Kąt wierzchołkowy:	140°
Kąt spirali:	30°

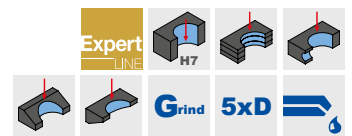
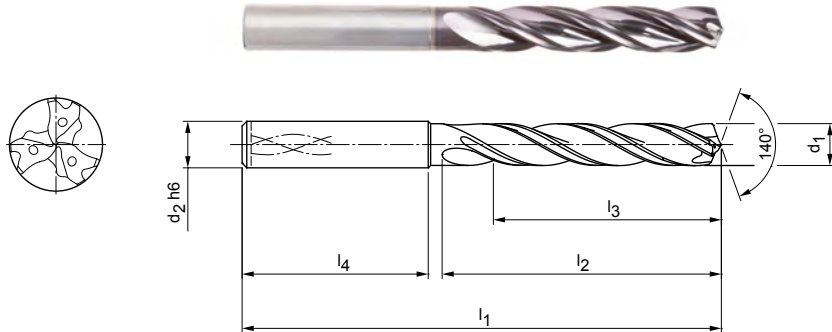

Magazynowa seria preferowana z typem chwytu HA

Wymiary						Typ chwytu HA	
d ₁ H7	d ₂ h6	l ₁	l ₂	l ₃	l ₄	Specyfikacja	Nr materiałowy
4,00	6	74	36	29	36	SDR301-4.000H7-HA05-HP358	31196627
5,00	6	82	44	35	36	SDR301-5.000H7-HA05-HP358	31196628
6,00	6	82	44	35	36	SDR301-6.000H7-HA05-HP358	31196629
8,00	8	91	53	43	36	SDR301-8.000H7-HA05-HP358	31196630
10,00	10	103	61	49	40	SDR301-10.000H7-HA05-HP358	31196631
12,00	12	118	71	56	45	SDR301-12.000H7-HA05-HP358	31196632
14,00	14	124	77	60	45	SDR301-14.000H7-HA05-HP358	31196633
16,00	16	133	83	63	48	SDR301-16.000H7-HA05-HP358	31196634
18,00	18	143	93	71	48	SDR301-18.000H7-HA05-HP358	31196635
20,00	20	153	101	77	50	SDR301-20.000H7-HA05-HP358	31196636

Wymiary podano w mm.

Do wykonywania otworów montażowych o klasie tolerancji H7, przy wystarczającej stabilności maszyny i chłodzeniu.

Zalecane parametry skrawania - patrz koniec rozdziału.

Wersje specjalne i inne powłoki wg zapytania ofertowego.

Zalecane parametry skrawania dla wiertło-rozwiertaków

Posuw i prędkość skrawania

Tritan-Drill-Reamer | SDR301

MZG*		Materiał obrabiany	Wytrzymałość/twardość [N/mm ²] [HRC]
P	P1	P1.1 Stale konstrukcyjne, użytkowe i uszlachetnione, stale niestopowe	< 700
		P1.2 Stale konstrukcyjne, użytkowe i uszlachetnione, stale niestopowe	< 1 200
	P2	P2.1 Stale azotowane, użytkowe i uszlachetnione, stale stopowe	< 900
		P2.2 Stale azotowane, użytkowe i uszlachetnione, stale stopowe	< 1 400
	P3	P3.1 Stale narzędziowe, łożyskowe, sprężynowe i stale szybko tnące**	< 800
		P3.2 Stale narzędziowe, łożyskowe, sprężynowe i stale szybko tnące**	< 1 000
		P3.3 Stale narzędziowe, łożyskowe, sprężynowe i stale szybko tnące**	< 1 500
	P5	P5.1 Staliwo	
K	K1	K1.1 Żeliwo z grafitem płatkowym (żeliwo szare), GJL	< 300
		K2.1 Żeliwo sferoidalne, GJS	< 500
	K2	K2.2 Żeliwo sferoidalne, GJS	≤ 800
		K2.3 Żeliwo sferoidalne, GJS	> 800
	K3	K3.1 Żeliwo wermikularne, GJV, (żeliwo ciągliwe), GJL	< 500
		K3.2 Żeliwo wermikularne, GJV, (żeliwo ciągliwe), GJL	> 500

PRZYKŁAD OBLICZEŃ

Należy pamiętać, że na wynik obliczeń mogą mieć wpływ dodatkowe parametry, takie jak rodzaj obrabiarki czy system mocowania narzędzia.

Wzór na obliczenie optymalnej średnicy znamionowej narzędzia:

$$(G_{OB} + G_{UB}) / 2$$

Przykład:

- otwór montażowy: \varnothing 10 F7
- maksymalna średnica otworu G_{OB} : 10,028 mm
- minimalna średnica otworu G_{UB} : 10,013 mm

$$\rightarrow (10,028 \text{ mm} + 10,013 \text{ mm}) / 2 = 10,021 \text{ mm} = \text{wybrana średnica znamionowa narzędzia: } 10,021 \text{ mm}$$

* Grupa materiałowa wg MAPAL

** Jeśli składniki stopu Cr, Mo, Ni, V, W wynoszą łącznie > 8%, należy wybrać następną w kolejności grupę materiałową MAPAL.

	Prędkość skrawania v_c [m/min]				Posuw f [mm] przy średnicy wiertła					
	Chłodzenie wewnętrzne	Chłodzenie zewnętrzne	Mgietka	Powietrze	4,00	5,50	7,50	10,50	14,50	20,00
	70	65	65		0,17	0,22	0,27	0,34	0,41	0,47
	65	55	55		0,22	0,27	0,34	0,42	0,51	0,59
	70	60	60		0,20	0,26	0,32	0,40	0,48	0,56
	50	40	40		0,17	0,21	0,26	0,32	0,38	0,44
	55	45	45		0,18	0,23	0,29	0,36	0,43	0,50
	40	40	40		0,15	0,19	0,24	0,30	0,36	0,41
	40	30	35		0,13	0,16	0,19	0,23	0,28	0,32
	70	60	60		0,20	0,26	0,32	0,40	0,48	0,56
	100	70	70	70	0,25	0,33	0,42	0,55	0,67	0,79
	135	85	100	100	0,24	0,32	0,40	0,51	0,62	0,72
	85	65	65		0,22	0,28	0,35	0,44	0,54	0,62
	50	35	45		0,11	0,13	0,16	0,20	0,24	0,28
	75	70	70		0,23	0,30	0,38	0,47	0,58	0,67
	70	60	60		0,20	0,25	0,31	0,38	0,46	0,53

Podane parametry skrawania to wartości orientacyjne.

Optymalne wartości dla danego przypadku obróbki należy ustalić w ramach próby lub podczas obróbki.

ROZWIĄZANIA SPECJALNE

Wiercenie w pełnym materiale wiertłem z węgla spiekane



Oprócz kompleksowego programu standardowego narzędzi wiertarskich MAPAL oferuje również narzędzia specjalne.

Indywidualne wymagania klientów wymagają rozwiązań specjalnych, dostosowanych do konkretnych zadań obróbczych. Dzięki rozległej wiedzy w zakresie obróbki metali i wieloletniemu doświadczeniu MAPAL jest kompetentnym partnerem dla firm na całym świecie w zakresie projektowania i produkcji narzędzi specjalnych oraz projektowania kompletnych procesów obróbki otworów. Program obejmuje wiertła spiralne i z rowkami prostymi wiórowymi, jak również wiertła stopniowane z węgla spiekane i wiertła z ostrzami PCD.

MAPAL – partner w dziedzinie rozwiązań specjalnych, opracowanych pod kątem konkretnych zastosowań.



Specjalne narzędzia wiertarskie MAPAL

- 1 Specjalne wiertło stopniowane z węgla spiekanego z trzema ostrzami i samocentrującym ścinem, do obróbki korbowodów w jednym kroku roboczym
- 2 Wiertło stopniowane z węgla spiekanego z trzema łysinkami i powłoką specjalną, do obróbki z dużą prędkością
- 3 Wiertło z węgla spiekanego do otworów pod gwinty, do obróbki korbowodów w dwóch krokach roboczych
- 4 Wiertło stopniowane z węgla spiekanego z trzema łysinkami i powłoką specjalną, do obróbki z dużą prędkością przegubów zwrotnicy z ADI 900
- 5 Wiertło specjalne z węgla spiekanego z geometrią Tritan-Drill i powłoką specjalną, do obróbki turbosprężarek
- 6 Wiertło-rozwiertak z trzema ostrzami i dodatkowymi ostrzami rozszerzającymi na obwodzie z powłoką specjalną, do obróbki osi z GJS
- 7 Wiertło pilotujące z węgla spiekanego, do obróbki korbowodów w dwóch krokach roboczych
- 8 Wiertło z węgla spiekanego do głębokiego wiercenia z powłoką specjalną, do obróbki bloków cylindrów z GJV
- 9 Wiertło do aluminium wykonane z węgla spiekanego, z trzema ostrzami, samocentrującym ścinem i polerowanymi na wysoki połysk rowkami wiórowymi, do obróbki AISi1
- 10 Wiertło stopniowane z węgla spiekanego ze szlifem czołowym 180°, do obróbki zaworów



ROZWIĄZANIA SPECJALNE

Wiercenie w pełnym materiale narzędziami z PCD

Do obróbki elementów z aluminium i innych metali nieżelaznych wykorzystywane są zazwyczaj narzędzia wiertarskie PCD z prostymi rowkami wiórowymi. W celu uzyskania wysokiej wydajności wiertła PCD dokonywana jest optymalizacja parametrów narzędzi i wzajemne dopasowanie elementów. Rowki wiórowe są polerowane na całej długości wiertła, aby ograniczyć do minimum tarcie wiórów. Optymalne osadzenie ostrzy PCD skutkuje dobrym zachowaniem wiertła podczas skrawania. Dzięki temu zmniejsza się również ilość ciepła oddawanego do elementu.

W przypadku procesów ze smarowaniem minimalną ilością czynnika smarująco-chłodzącego (MMS) firma MAPAL zmodyfikowała rozmieszczenie wylotów chłodziwa na narzędziach tak, by aerozol docierał dokładnie do tych miejsc, które wymagają smarowania. Zmniejsza to ryzyko powstawania narostów i wydłuża wytrzymałość wiertła.

Nowoczesne procesy obróbcze coraz częściej wymagają jednak narzędzi wiertarskich z ostrzami PCD o dużym kącie spirali.

Narzędzia spiralne PCD umożliwiają bezpieczną i wydajną obróbkę otworów. Dzięki „mechanicznemu” odprowadzaniu wiórów wyeliminowany zostaje problem ich zakleszczania, a także złamań narzędzi. Wysokie dodatnie kąty natarcia zmniejszają niezbędne siły skrawania. Kilka operacji, takich jak wiercenie w pełnym materiale i nawiercanie, można wykonać w ramach jednego kroku roboczego. Skrócenie czasu obróbki zwiększa wydajność przy zachowaniu wysokiej stabilności procesu i jakości otworu.

Cechy charakterystyczne narzędzia



1 Ostrza PCD

2 Spiralny i polerowany na wysoki połysk rowek wiórowy

3 Zoptymalizowane wyloty chłodziwa w procesach ze smarowaniem MMS

Optymalnie osadzone ostrza PCD

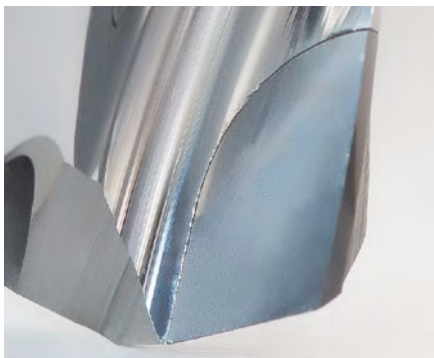

Optymalne osadzenie segmentów PCD w spiralnym, zaokrąglonym ze wszystkich stron rowku, stawia wysokie wymagania pod względem technologii produkcji. Najnowocześniejsze urządzenia produkcyjne gwarantują niezawodność i powtarzalność procesu projektowania i stabilność spiralnych narzędzi wiertarskich PCD. W celu ciągłego udoskonalania narzędzi, za pośrednictwem doradców technicznych i specjalistów ds. produktów w firmie MAPAL, w procesie tym uwzględniane są wszechstronne informacje dotyczące zastosowań.

Polerowany na wysoki połysk rowek wiórowy



Rowki wiórowe są polerowane na wysoki połysk, dzięki czemu zminimalizowane zostaje tarcie powodowane przez wióry, a w rezultacie zmniejsza się również ilość ciepła oddawanego do elementu. Spiralny kształt rowków wiórowych umożliwia „mechaniczne” usuwanie wiórów. Wysokie dodatnie kąty natarcia zmniejszają niezbędne siły skrawania.

Optymalne do procesów ze smarowaniem MMS



Prawidłowe rozmieszczenie wylotów chłodziwa w procesach obróbki ze smarowaniem MMS ma kluczowe znaczenie dla parametrów roboczych wiertła. Aerosol musi docierać do tych miejsc, które wymagają smarowania. Przykładowe korzyści to mniejsze ryzyko powstawania narostów i oczywiście wydłużenie wytrzymałości wiertła.



Rozwiercanie i rozwiercanie precyzyjne

Najwyższa dokładność zgodnie z zasadą MAPAL



PRZEGLĄD PRODUKTÓW

Rozwiercanie i rozwiercanie precyzyjne

Narzędzia do precyzyjnej obróbki otworów stanowią główny obszar kompetencji firmy MAPAL. Historia sukcesu, którą MAPAL pisze w tej dziedzinie do dziś, rozpoczęła się od „praprzodka rozwiertaka” w 1954 roku. Dziesięciolecia doświadczeń oraz ciągły rozwój i optymalizacja rozwiązań narzędziowych gwarantują, że MAPAL oferuje właściwe rozwiązania w zależności od stopnia skomplikowania obróbki i wymagań pod względem precyzji. Oprócz rozwiązań specjalnych dostosowanych do potrzeb klienta MAPAL oferuje dziś także zróżnicowany asortyment narzędzi standardowych do rozwiercania i rozwiercania precyzyjnego.

Rozwiercanie i rozwiercanie precyzyjne są najczęściej stosowanymi metodami obróbki precyzyjnej

otworów i przekonują najbardziej dokładnymi rezultatami. Ta sama precyzja, którą narzędzia MAPAL zapewniają w praktyce, jest podstawą ich produkcji. W zależności od złożoności obróbki oraz wymagań dotyczących precyzji i powierzchni, MAPAL oferuje odpowiednie rozwiązanie:

Uzyskanie maksymalnej precyzji jest możliwe dzięki rozwiertakom jednoostrzowym oraz rodzim do rozwiercania precyzyjnego z listwami prowadzącymi i ostrzami WP. W skład programu wchodzi również stałe rozwiertaki wieloostrozowe: rozwiertaki z wymiennymi głowicami HPR w połączeniu z precyzyjnymi systemami mocowania, rozwiertaki wysoko wydajne z węgla spiekowego lub cermetu, jak również systemy do obróbki dużych średnic.



Basic Line:

Uniwersalne narzędzia, szeroki zakres zastosowań, niskie koszty nabycia



Performance Line:

Narzędzia wysoko wydajne, szeroki zakres zastosowania, zapewnia wysoką produktywność w produkcji seryjnej



Expert Line:

Narzędzia specjalistyczne do wybranych zastosowań, maksymalna precyzja i produktywność

Stale rozwiertaki wieloostrozowe



Rozwiertak wysoko wydajny | FXR

Rozwiertaki wysoko wydajne serii FXR – narzędzia z wyboru, gdy wymagane są krótkie czasy cyklu – są oferowane w wersjach z różnymi materiałami skrawającymi i powłokami. Dzięki temu za ich pomocą można ekonomicznie i stabilnie obrabiać niemal wszystkie obrabiane materiały. Narzędzia są dostępne w zakresie średnicy od 2,800 do 20,200 mm i osiągną tolerancje IT7 bez konieczności dokonywania regulacji.

Zakres \varnothing : 2,800–20,200 mm*



Rozwiertaki wysoko wydajne z końcówkami | MOR/MRP

Prosty, wydajny i znormalizowany – tak można najkrócej opisać system rozwiercania typoszeregu MonoReam. Ostrza rozwiertaków wysoko wydajnych serii FXR są przylutowane do korpusu. Rozwiertaki MOR – w przeciwieństwie do rozwiertaków FXR – mogą być regenerowane. Jest to możliwe dzięki śrubie rozprężnej, która rozszerza średnicę rozwiertaka, co pozwala na ponowne szlifowanie.

Zakres \varnothing : 3,850–40,200 mm*



Rozwiertak z wymienną głowicą HPR ze złączem HFS

Jeśli wymagana jest maksymalna ekonomiczność, w zakresie małych średnic zaleca się stosowanie rozwiertaków z wymienną głowicą HPR. Dzięki wysoko precyzyjnemu złączu HFS, mimo systemu z wymienną głowicą, zapewniona jest niska wartość bicia i maksymalna dokładność przezbierania. Przy tym obsługa narzędzia jest bardzo prosta. Rozwiertaki HPR dostępne są zarówno z ostrzami przylutowanymi na stałe, jak i regulowanymi.

Zakres \varnothing : 7,000–65,000 mm*



Narzędzia z listwami prowadzącymi



Rozwiertak jednoostrzowy

Do uzyskania jak największej precyzji praktycznie bezkonkurencyjne są rozwiertaki jednoostrzowe z listwami prowadzącymi opartymi na zasadzie MAPAL. Ich płytki skrawające mają dwie krawędzie skrawające i są dostępne w wersjach z nakrojami specjalnymi.

Zakres \varnothing : 5,000–30,290 mm*



Strona 316

Strona 350

Strona 368

Strona 478

* Zakres średnicy może się różnić w zależności od typoszeregu.

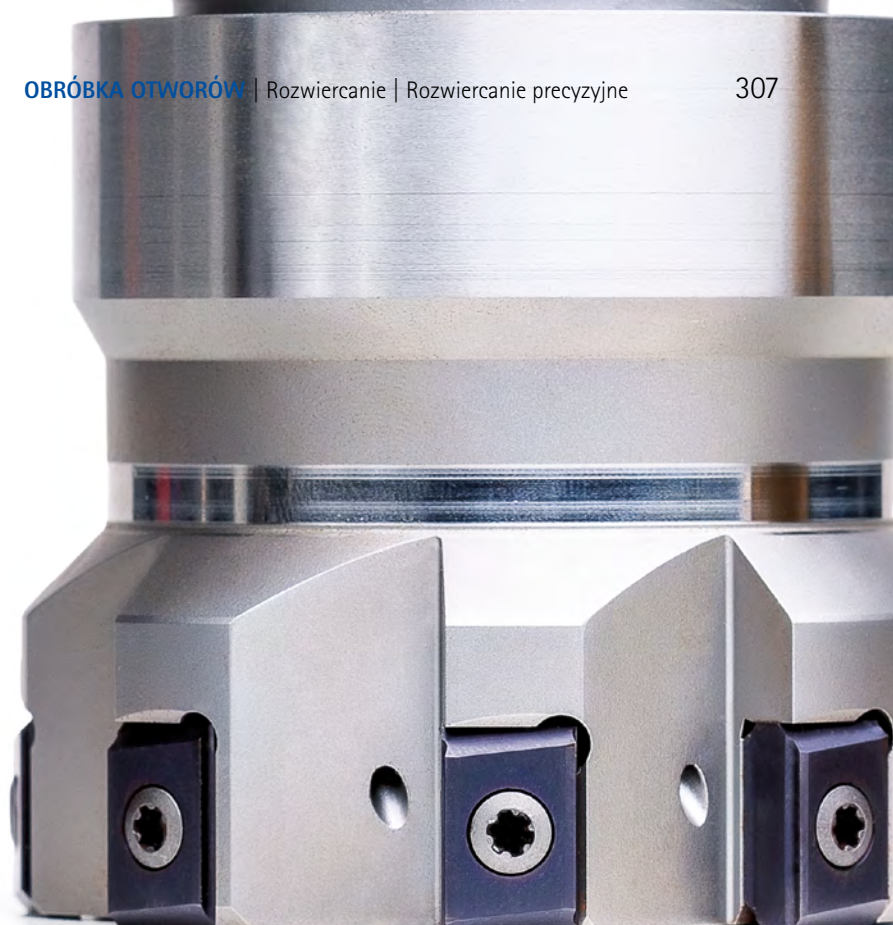

	Rozwiązania do otworów o dużych średnicach	Rozwiązania specjalne
		
<p>System EasyAdjust</p> <p>Opracowanie systemu EasyAdjust zaowocowało znaczną redukcją czasu potrzebnego na przygotowanie rozwiertaka do pracy. Najważniejszym elementem systemu jest innowacyjna kasetka, która pozwala na stabilne mocowanie bez luzów sześć- lub czterostrzowych płytek skrawających i zapewnia odpowiednią zbieżność płytki dopasowaną do gatunku obrabianego materiału. W przeciwieństwie do tradycyjnych rozwiertaków uzbrajanych w płytki WP i HX, w rozwiertakach z systemem EasyAdjust pożądaną średnicę narzędzia ustawia się za pomocą jednej śruby.</p> <p>Zakres \varnothing: od 20,000 mm*</p> <p>P M K N S H</p>	<p>Rozwiązania do otworów o dużych średnicach</p> <p>Wielostrzowe rozwiertaki wysoko wydajne do dużych zakresów średnicy. HPR400 – szybka wymiana ostrzy na miejscu bez długiego powtarzania czynności przygotowawczych. HPR400 plus – cztery krawędzie skrawające zamiast jednej. Łatwe obracanie i wymiana płytek skrawających.</p> <p>Zakres \varnothing: 63,000–319,999 mm*</p> <p>P M K N H</p>	<p>Narzędzia specjalne skrojone na miarę</p> <p>Specjalne zadania obróbcze wymagają specjalnych narzędzi. Dlatego MAPAL oferuje narzędzia do rozwiercania w wykonaniach specjalnych, które są indywidualnie dopasowane do wymagań klienta. Specjalne geometrie nakroju i powłoki oraz narzędzia stopniowe zapewniają optymalną realizację każdego zadania. Rozwiązania łączone z innymi technologiami narzędziowymi firmy MAPAL mogą ponadto zwiększyć produktywność i skrócić czas nieproduktywny.</p>
<p>Strona 514</p>	<p>Strona 562</p>	<p>Strona 572</p>

SYSTEM DOBORU NARZĘDZI

Stałe rozwiertaki wielostrzowe | Narzędzia z listwami prowadzącymi

Stałe rozwiertaki wielostrzowe

Najlepszy wybór w następujących zastosowaniach:

- Obróbka z dużymi prędkościami posuwu
- Najwyższa wydajność w produkcji seryjnej
- Obrabiane materiały ścierne i twarde
- Obróbka wielowrzecionowa
- Obróbka w zakresie średnic < 5 mm



Narzędzia z listwami prowadzącymi

Najlepszy wybór w następujących zastosowaniach:

- Niestabilne warunki pracy maszyny
- Optymalna współpraca z uchwytem pływającym na tokarce
- Obróbka prętów i elementów cienkościennych
- Niekorzystny stosunek długości do średnicy
- Wyjątkowo wysokie tolerancje kształtu i położenia





Dzięki stałym rozwiertakom wieloostrowym możliwe jest radykalne skrócenie czasu obróbki. Obecność kilku krawędzi skrawających umożliwia wielokrotne zwiększenie prędkości posuwu, co jest decydującym czynnikiem wpływającym

na czas obróbki. Dzięki specjalnie opracowanym systemom i najnowszej technologii produkcji również w przypadku tych narzędzi MAPAL oferuje najwyższe dokładności.

► [Więcej od strony 311](#)

WŁASNOŚCI NARZĘDZI

- Wykonania stałe bez konieczności regulacji
- Wersje z precyzyjną regulacją zoptymalizowane pod kątem ponownego szlifowania
- Precyzyjne i łatwe w obsłudze systemy z wymienną głowicą
- Program standardowy obejmuje różne klasy wydajności
- Regeneracja narzędzia dla wysokiej ekonomiczności
- Seria preferowana dostępna z magazynu, wielkości pośrednie dostępne w krótkich terminach



Technologia listew prowadzących MAPAL jest bezkonkurencyjna w zakresie precyzyjnej obróbki otworów w dowolnych materiałach konstrukcyjnych. Żadne inne narzędzia nie gwarantują uzyskania takich dokładności średnicy

otworu, okrągłości i walcowości, jak również jakości powierzchni – lub przynajmniej nie w sposób równie ekonomiczny.

► [Więcej od strony 477](#)

WŁASNOŚCI NARZĘDZI

- Najwyższa precyzja regulacji z dokładnością do mikrometra
- Technologia płytek skrawających dla maksymalnej elastyczności w wyborze materiału skrawającego
- Wielkości pośrednie i wszystkie tolerancje dostępne w krótkich terminach



STAŁE ROZWIERTAKI WIELOOSTRZOWE

Monolityczne rozwiertaki wielostrzowe

Pomoc w doborze narzędzia	312
---------------------------------	-----

FixReam FXR

Przegląd produktów	316
Zestawienie modeli FXR	318
FXR510	322
FXR500	330
FXR505	332
FXR503-short	342
Zalecane parametry skrawania	344

MonoReam MOR

Przegląd produktów	350
Zestawienie modeli MOP/MRP	352
MOR710	356
MOR700	358
MOR705	359
MRP510	362
MRP505	363
Zalecane parametry skrawania	364

Rozwiertaki z wymienną głowicą HPR











Przegląd produktów	368
Zestawienie modeli HPR	370
HPR130	374
HPR131	379
HPR100	383
HPR110	390
HPR180	396
HPR150	405
HPR230	414
HPR231	418
HPR200	422
HPR210	426
HPR280	430
HPR250	438
Zalecane parametry skrawania	446
Naddatki na rozwiercanie	458
Program uchwytów HFS	460
Części zamienne i osprzęt	474



WYBÓR ROZWIERTAKA WIELOOSTRZOWEGO

Krok po kroku do właściwego rozwiertaka

Poszukują Państwo na przykład rozwiertaka wielostrzowego z węgla spiekanego o średnicy 10,000H7 do obróbki otworu nieprzelotowego w stali? Poniżej znajdą Państwo wskazówki, które krok po kroku pomogą Państwu w wyborze właściwego narzędzia.

1	Budowa	Proszę wybrać preferowane wykonanie (monolityczne lub modułowe).	 Monolityczny	 Złącze modułowe HFS
2	Parametry otworu	Proszę sprawdzić, czy cechy geometryczne narzędzia spełniają wymogi. Proszę wybrać zakres średnicy i wymaganą tolerancję.	 Zakres średnicy	 Osiągalna tolerancja otworu $\geq IT7$
3	Klasa produktu	Proszę wybrać klasę produktu.	 Basic LINE	Basic Line: Uniwersalne narzędzia, szeroki zakres zastosowań, niskie koszty nabycia
4	Grupa materiałowa	Proszę określić grupę materiału obrabianego przedmiotu wg MZG (klasyfikacji grup materiałowych MAPAL).	 P Stal	 M Stal nierdzewna
5	Rodzaj otworu	Proszę określić wymogi, jakie musi spełnić narzędzie w zależności od rodzaju otworu.	 Otwór przelotowy	 Otwór nieprzelotowy
6	Produkt	Proszę wybrać odpowiedni rozwiertak. Produkty z magazynowej serii preferowanej są dostępne w krótkim terminie, natomiast produkty o parametrach możliwych do skonfigurowania mogą być konstruowane dowolnie w ramach wcześniej określonych zakresów.	 Magazynowa seria preferowana	 CONFIG Dowolna konfiguracja





Performance Line:
Narzędzia wysoko wydajne, szeroki zakres zastosowania, zapewnia wysoką produktywność w produkcji seryjnej



Expert Line:
Narzędzia specjalistyczne do wybranych zastosowań, maksymalna precyzja i produktywność



Żeliwo



Metale nieżelazne i tworzywa sztuczne

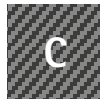

Materiały kompozytowe



Nadstopy i tytan



Stal utwardzana i staliwo

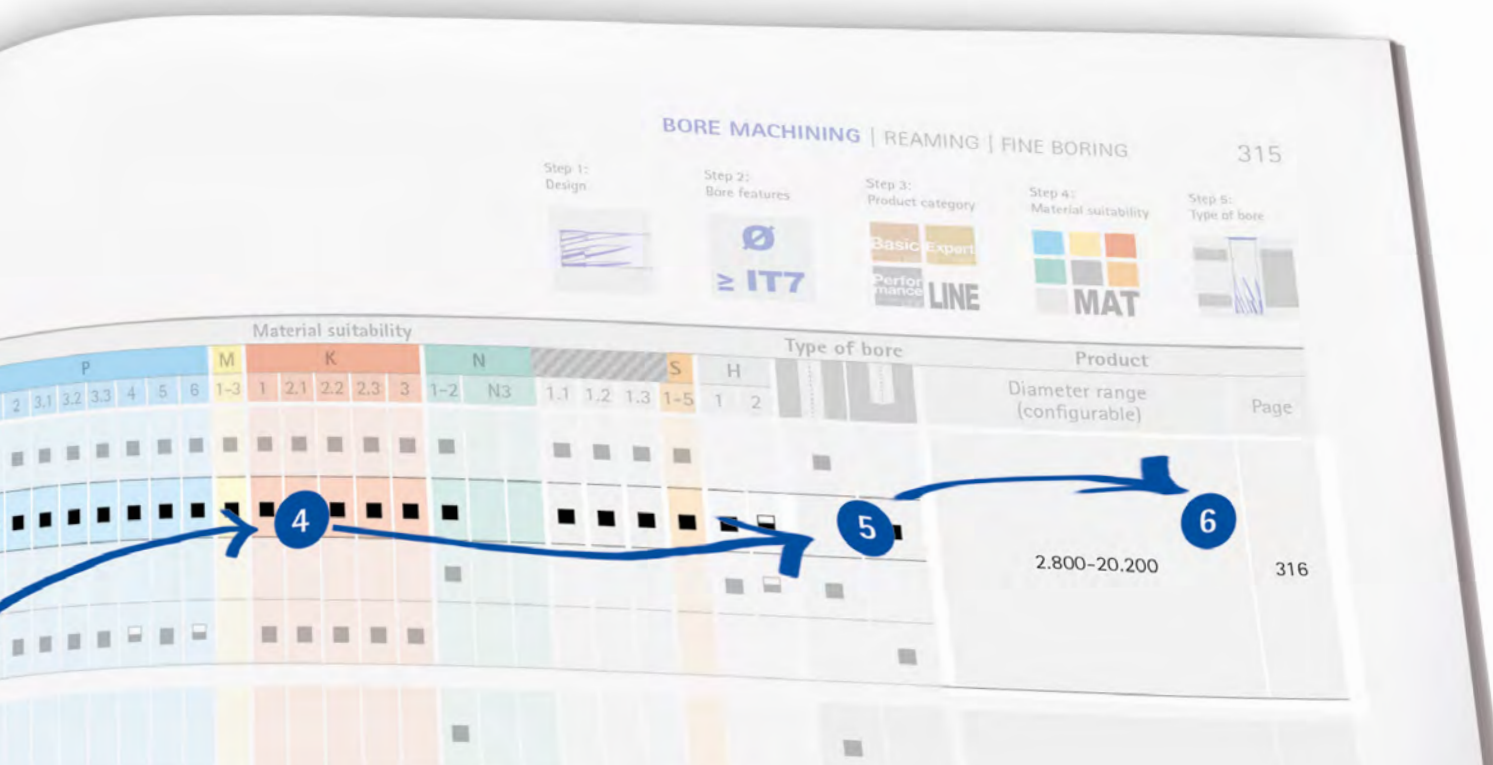

BORE MACHINING | REAMING | FINE BORING

Step 1:
Design



Step 2:
Bore features

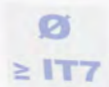

Step 3:
Product category



Step 4:
Material suitability



Step 5:
Type of bore



Material suitability

Type of bore

Product

P						M	K				N		S			H		Diameter range (configurable)	Page		
2	3.1	3.2	3.3	4	5	6	1-3	1	2.1	2.2	2.3	3	1-2	N3	1.1	1.2	1.3			1-5	1
■	■	■	■	■	■	■	■	■	■	■	■	■	■	■	■	■	■	■	■	■	■
■	■	■	■	■	■	■	■	■	■	■	■	■	■	■	■	■	■	■	■	■	■
■	■	■	■	■	■	■	■	■	■	■	■	■	■	■	■	■	■	■	■	■	■

2.800-20.200



Rozwiertaki | System doboru narzędzi

Budowa	Zalecany zakres średnicy [mm]	Tolerancja	Typoszereg			Klasa produktu	
				Średnica	Seria		
	3,000 - 14,000	≥ IT6	FixReam	<p>Rozwiertak z węgla spiekane- nego do szerokiego zakresu zastosowań. W zależności od średnicy, rozwiertaki wysoko wydajne FixReam mają od czterech do ośmiu ostrzy z chłodzeniem wewnętrznym, dzięki czemu osiągają odpowiednio wysokie prędkości posuwu.</p>	2,800 - 20,200*	FXR510	Perfor- mance LINE
					2,800 - 20,200*	FXR505	
					3,701 - 20,200*	FXR500	
					2,800 - 20,100*	FXR503	
	14,000 - 40,000	≥ IT6	MonoReam	<p>MOR700 jest używany jako na- rzędzie stałe, ale ten typosze- reg jest zoptymalizowany pod kątem ponownego szlifowania. Do rozszerzania średnicy roz- wiertaka służy jednoczęściowa śruba rozprężna.</p>	7,700 - 40,200	MOR700	Perfor- mance LINE
						MOR705	
						MOR710	
	4,000 - 8,000	≥ IT6	MonoReam Plus	<p>Szczególnie odpowiedni do obróbki żeliwa i stali. Tuleja zapewnia optymalne dopro- wadzenie chłodziwa do ostrzy HPC.</p>	3,850 - 8,200	MRP505	Perfor- mance LINE
						MRP510	
	7,000 - 65,000	≥ IT5	HPR	<p>Wysoce precyzyjny system z wymienną głowicą w wyko- naniu stałym i z precyzyjną regulacją.</p>	7,000 - 65,000	HPR1XX stałe	Perfor- mance LINE
						HPR2XX z precyzyjną regulacją	
	63,000 - 319,999	≥ IT7	HPR 400 400 plus	<p>Wymienne ostrza ułatwiają ich wymianę na miejscu. Dzięki temu możliwe jest uzyskanie bardzo krótkich czasów przezbierania.</p>	63,000 - 319,999	HPR400 400 plus	Expert LINE

* Zakres średnicy może się różnić w zależności od typoszeregu.

Krok 1:
Budowa



Krok 2:
Parametry otworu



Krok 3:
Klasa produktu



Krok 4:
Grupa materiałowa



Krok 5:
Rodzaj otworu

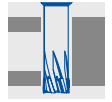

	Grupa materiałowa														Rodzaj otworu						Produkt								
	P						M	K					N		C			S	H		Zakres średnicy (możliwość konfiguracji)	Strona							
	1	2	3.1	3.2	3.3	4	5	6	1-3	1	2.1	2.2	2.3	3	1-2	N3	1.1	1.2	1.3	1-5			1	2					
	■	■	■	■	■	■	■	■	■	■	■	■	■	■		■	■	■	■			■	■			2,800-20,200*	316		
	■	■	■	■	■	■	■	■	■	■	■	■	■	■		■	■	■	■	■	■	■	■						
														■						■	■	■	■						
	■	■	■	■	■	■	■	■	■	■	■	■	■											■	■				
														■	■									■	■	7,700-40,200	350		
	■	■	■	■	■	■	■	■	■	■	■	■	■	■	■									■	■				
	■	■	■	■					■	■														■	■	3,850-8,200	350		
	■	■	■	■					■	■														■	■				
	■	■	■	■	■	■	■	■	■	■	■	■	■	■					■			■	■			7,000-65,000	368		
	■	■	■	■	■	■	■	■	■	■	■	■	■	■					■			■	■						
	■	■	■	■	■	■	■	■	■	■	■	■	■	■										■	■	63,000-319,999	562		

PRZEGLĄD PRODUKTÓW

FixReam: FXR500 | FXR510 | FXR505 | FXR503

Typoszeregi rozwiertaków wysoko wydajnych FXR z węgla spiekane- go obejmują szeroki zakres zastosowań. W zależności od średnicy roz- wiertaki wysoko wydajne FixReam mają od czterech do ośmiu ostrzy z chłodzeniem wewnętrznym, dzięki czemu osiągają odpowiednio wyso- kie prędkości posuwu. Dzięki zastosowaniu różnych materiałów skra- wających i powłok możliwa jest ekonomiczna i stabilna obróbka wielu materiałów obrabianych w zakresie średnicy od 2,850 do 20,200 mm* bez procedury regulacji w zakresie tolerancji IT7.

Do zastosowania w miejscach o ograniczonej ilości miejsca, np. na au- tomatach tokarskich, dostępne są wersje krótkie „Short”.



FixReam



FixReam | trzpień z węgla spiekane- go FXR500

Rozwiertaki wysoko wydajne z węgla spiekane- go z prostym rowkiem wióro- wym i chłodzeniem wewnętrznym. Seria preferowana w tolerancji H7.

Zakres \varnothing serii preferowanej: 3,701-20,200 mm*



FixReam | trzpień z węgla spiekane- go FXR510

Rozwiertaki wysoko wydajne z węgla spiekane- go z rowkiem le- woskrętnym i chłodzeniem wewnętrznym. Seria preferowana w tolerancji H7.

Zakres \varnothing serii preferowanej: 2,800-20,200 mm*





FixReam | korpus z węgla spiekanego FXR505

Rozwiertaki wysoko wydajne z węgla spiekanego z prostym rowkiem wiórowym i chłodzeniem wewnętrznym. Seria preferowana w tolerancji H7.

Zakres \varnothing serii preferowanej: 2,800–20,200 mm*



FixReam | korpus z węgla spiekanego FXR503-short

Bardzo krótki, wysokowydajny rozwiertak z pełnego węgla, specjalnie zaprojektowany do stosowania na automatach tokarskich. Jako seria preferowana w H7.

Zakres \varnothing serii preferowanej: 2,800–20,100 mm*



Zestawienie rozwiertaków FixReam (1/2)

Klasa produktu	Rodzaj otworu	Grupa materiałowa												
		P				M	K	N			C	S	H	
		1-3	4	5	6	1-3	1-3	1	2	4	1	1-5	1	2
Performance LINE	[Symbol: dwa pionowe słupki]	[Symbol: czarna kropka]	[Symbol: czarna kropka]	[Symbol: czarna kropka]	[Symbol: czarna kropka]	[Symbol: czarna kropka]	[Symbol: czarna kropka]							
			[Symbol: czarna kropka]		[Symbol: czarna kropka]	[Symbol: czarna kropka]								
								[Symbol: czarna kropka]						
								[Symbol: czarna kropka]	[Symbol: czarna kropka]	[Symbol: czarna kropka]				
	[Symbol: U-shaped]	[Symbol: czarna kropka]	[Symbol: czarna kropka]	[Symbol: czarna kropka]	[Symbol: czarna kropka]	[Symbol: czarna kropka]	[Symbol: czarna kropka]							
		[Symbol: czarna kropka]	[Symbol: czarna kropka]	[Symbol: czarna kropka]	[Symbol: czarna kropka]	[Symbol: czarna kropka]	[Symbol: czarna kropka]							
			[Symbol: czarna kropka]		[Symbol: czarna kropka]	[Symbol: czarna kropka]								
								[Symbol: czarna kropka]	[Symbol: czarna kropka]	[Symbol: czarna kropka]				
	[Symbol: U-shaped]	[Symbol: czarna kropka]	[Symbol: czarna kropka]	[Symbol: czarna kropka]	[Symbol: czarna kropka]	[Symbol: czarna kropka]	[Symbol: czarna kropka]							
		[Symbol: czarna kropka]	[Symbol: czarna kropka]	[Symbol: czarna kropka]	[Symbol: czarna kropka]	[Symbol: czarna kropka]	[Symbol: czarna kropka]							
			[Symbol: czarna kropka]		[Symbol: czarna kropka]	[Symbol: czarna kropka]								
								[Symbol: czarna kropka]	[Symbol: czarna kropka]	[Symbol: czarna kropka]				
	[Symbol: U-shaped]	[Symbol: czarna kropka]	[Symbol: czarna kropka]	[Symbol: czarna kropka]	[Symbol: czarna kropka]	[Symbol: czarna kropka]	[Symbol: czarna kropka]							
		[Symbol: czarna kropka]	[Symbol: czarna kropka]	[Symbol: czarna kropka]	[Symbol: czarna kropka]	[Symbol: czarna kropka]	[Symbol: czarna kropka]							
			[Symbol: czarna kropka]		[Symbol: czarna kropka]	[Symbol: czarna kropka]								
								[Symbol: czarna kropka]	[Symbol: czarna kropka]	[Symbol: czarna kropka]				

Przykład zamówienia:

Typoszereg

F X R

FixReam

5 0 0

Wersje:
Węgiel spiekany

G

Rodzaj otworu:
0 | 2 = otwór przelotowy
3 | 5 = otwór nieprzelotowyKąt pochylenia ostrza:
0 = prosty rowek wiórowy
1 = rowek lewoskrętny

Średnica

Ø 2 0

Średnica otworu
Średnica szlifowania narzędzia
(Miejsce jest zajęte wyłącznie w przypadku wariantu G)

. 0 0 0

Tolerancja

- 3

Tolerancja IT lub wymiary w µm (przykład: +30+10) lub dla wariantu G tolerancja produkcyjna średnicy szlifowania narzędzia, np. -3 µm

Krok 1:
Klasa produktu



Krok 2:
Rodzaj otworu



Krok 3:
Grupa materiałowa



Krok 4:
Wersja



Krok 5:
Wstępnie skonfigurowane średnice lub konfiguracja



	Wersja					Wstępnie skonfigurowane średnice		Konfiguracja
	d1	Materiał skrawający	Nacięcie			Typoszereg	Strona	
	2,800-20,200	HP145	MG1M			FXR510	322	FXR510 Wersja stała, rowek lewoskrętny, do wykonywania otworu przelotowego
	3,701-20,200	HP145	MF1M			FXR510	326	
	3,701-20,200	HP622	MG0A			FXR500	330	
	2,800-20,200	HU612	MG1M			FXR510	324	FXR500 Wersja stała, prosty rowek wiórowy, do wykonywania otworu przelotowego
	3,701-20,200	HC614	MF1M			FXR510	329	
	3,701-20,200	HP625	MF1M			FXR510	328	
	3,701-20,200	HP141	MFOA			FXR500	331	
	2,800-20,200	HP145	MVOA			FXR505	332	
	2,800-20,100	HP145	MC1F			FXR503	342	FXR505 Wersja stała, prosty rowek wiórowy, do obróbki otworu nieprzelotowego
	3,701-20,200	HP145	MT0A			FXR505	334	
	3,701-20,200	HP622	MVOA			FXR505	335	
	2,800-20,200	HU612	MVOA			FXR505	336	
	3,701-20,200	HC614	MVOA			FXR505	339	FXR503-short Wersja stała, prosty rowek wiórowy, do obróbki otworu nieprzelotowego
	3,701-20,200	HP625	MT0A			FXR505	338	
	3,701-20,200	HP141	MT0A			FXR505	340	

Konfiguracja typoszeregu na następnej stronie.

Nakrój [Lead]

Materiał skrawający [Cut]

M	G	O	A	-	H	P	6	2	2
<p>Typ nakroju i kąt natarcia:</p> <p>MG0A MT0A Wyjaśnienie geometrii nakroju – patrz strony 752</p> <p>MG1M MFOA</p> <p>MF1M MC1F</p> <p>MVOA</p>				<p>Materiał skrawający:</p> <p>HP145 HP141</p> <p>HU612 HP625</p> <p>HP622</p> <p>HC614</p>					

Zestawienie rozwiertaków FixReam | Konfiguracja (2/2)

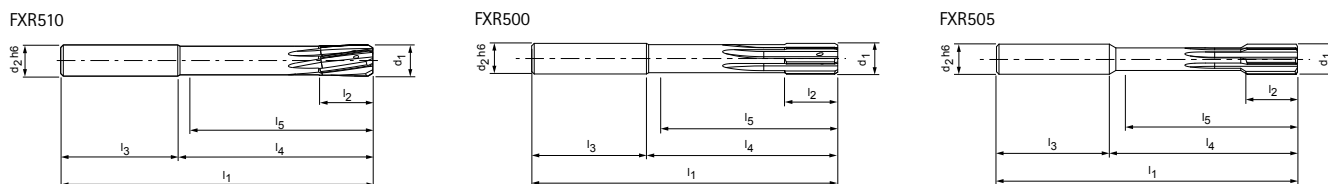

Wymiary narzędzia

FXR510

d ₁	d ₂	l ₁	l ₂	l ₃	l ₄	l ₅	z
2,800 - 3,700	4	65	12	28	37	34	4
3,701 - 4,700	6	75	12	36	39	34	4
4,701 - 6,200	6	75	12	36	39	35	4
6,201 - 7,200	8	100	16	36	64	59	6
7,201 - 8,200	8	100	16	36	64	60	6
8,201 - 9,200	10	100	20	40	60	55	6
9,201 - 10,200	10	120	20	40	80	76	6
10,201 - 11,200	12	120	20	45	75	70	6
11,201 - 12,200	12	120	20	45	75	71	6
12,201 - 14,200	14	130	22	45	85	80	6
14,201 - 15,200	16	130	22	48	82	77	6
15,201 - 16,200	16	150	25	48	102	97	6
16,201 - 18,200	18	150	25	48	102	97	8
18,201 - 20,200	20	150	25	50	100	95	8

FXR505

d ₁	d ₂	l ₁	l ₂	l ₃	l ₄	l ₅	z
2,800 - 3,350	4	65	12	37	28	33	4
3,351 - 3,700	4	65	12	28	37	33	4
3,701 - 6,200	6	75	12	36	39	34	4
6,201 - 8,200	8	100	16	36	64	58	6
8,201 - 9,200	10	100	20	40	60	54	6
9,201 - 10,200	10	120	20	40	80	74	6
10,201 - 12,200	12	120	20	45	75	68	6
12,201 - 14,200	14	130	22	45	85	78	6
14,201 - 15,200	16	130	22	48	82	75	6
15,201 - 16,200	16	150	25	48	102	95	6
16,201 - 18,200	18	150	25	48	102	95	6
18,201 - 20,200	20	150	25	50	100	92	6

Tolerancje dla wariantu G/wariantu stałego FXR5XX:

Materiał skrawający	Zakres średnicy
	Ø2,800 - 20,200
Bez powłoki	-0,003
HU612	
Z powłoką (grubość powłoki 0,8-2 µm)	-0,004
HP145	
HP625	
HP622	
HC614	-0,005
Z powłoką (grubość powłoki 2-4 µm)	
HP141	

Wyjaśnienie – wariant G FXR

Dopuszczalne tolerancje obrabianego przedmiotu przy wyborze średnicy narzędzia

Wersja „wariant G”:

Wariant G wskazuje średnicę narzędzia rozwiertaka z naszymi tolerancjami produkcyjnymi. Tolerancje produkcyjne zależą od materiału skrawającego – patrz najmniejsze dopuszczalne tolerancje dla wariantu G.

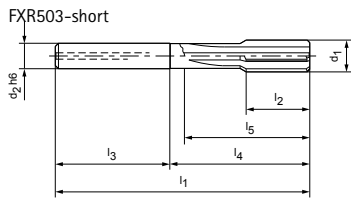

FXR500

d_1	d_2	l_1	l_2	l_3	l_4	l_5	z
3,701 - 4,700	6	75	12	36	39	34	4
4,701 - 6,200	6	75	12	36	39	35	4
6,201 - 7,200	8	100	16	36	64	59	6
7,201 - 8,200	8	100	16	36	64	60	6
8,201 - 9,200	10	100	20	40	60	55	6
9,201 - 10,200	10	120	20	40	80	76	6
10,201 - 11,200	12	120	20	45	75	70	6
11,201 - 12,200	12	120	20	45	75	71	6
12,201 - 14,200	14	130	22	45	85	80	6
14,201 - 15,200	16	130	22	48	82	77	6
15,201 - 16,200	16	150	25	48	102	97	6
16,201 - 18,200	18	150	25	48	102	97	8
18,201 - 20,200	20	150	25	50	100	95	8

FXR503-short

d_1	d_2	l_1	l_2	l_3	l_4	l_5	z
2,800 - 4,050	4	56	12	28	28	24	4
4,051 - 5,100	6	64	12	36	28	23	4
5,101 - 5,600	6	64	12	36	28	24	4
6,101 - 6,600	8	75	16	36	39	32	6
6,601 - 7,100	8	75	16	36	39	34	6
7,101 - 8,100	8	75	16	36	39	35	6
8,101 - 10,100	8	75	20	36	39	35	6
10,101 - 11,600	10	80	20	40	40	35	6
11,601 - 13,100	12	90	22	45	45	40	6
13,101 - 15,100	14	90	22	45	45	40	6
15,101 - 18,100	16	100	25	48	52	47	8
18,101 - 20,100	18	100	25	48	52	47	8



Rozwiązania specjalne dostosowane do potrzeb klienta do obróbki wieloetapowej.

FixReam

Wersja monolityczna, rowek lewoskrętny, do wykonywania otworu przelotowego
FXR510

Wersja:

Średnica rozwiertaka:

2,800 - 20,200 mm

Nakrój:

MG1M

Materiał skrawający:

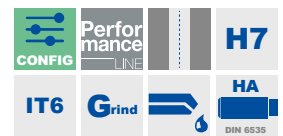
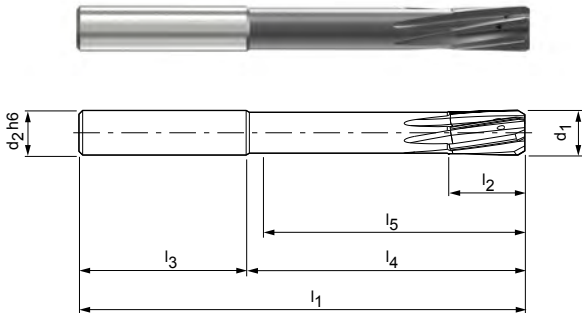
 HP145
Węgiel spiekany z
powłoką PVD

Magazynowa seria preferowana w tolerancji H7

d ₁ H7	Wymiary						z	Specyfikacja	Nr materiałowy
	d ₂ h6	l ₁	l ₂	l ₃	l ₄	l ₅			
4,000	6	75	12	36	39	34	4	FXR510Ø4.000H7MG1M-HP145	30570722
5,000	6	75	12	36	39	35	4	FXR510Ø5.000H7MG1M-HP145	30570724
6,000	6	75	12	36	39	35	4	FXR510Ø6.000H7MG1M-HP145	30570726
7,000	8	100	16	36	64	59	6	FXR510Ø7.000H7MG1M-HP145	30570728
8,000	8	100	16	36	64	60	6	FXR510Ø8.000H7MG1M-HP145	30570730
9,000	10	100	20	40	60	55	6	FXR510Ø9.000H7MG1M-HP145	30570732
10,000	10	120	20	40	80	76	6	FXR510Ø10.000H7MG1M-HP145	30570734
11,000	12	120	20	45	75	70	6	FXR510Ø11.000H7MG1M-HP145	30570736
12,000	12	120	20	45	75	71	6	FXR510Ø12.000H7MG1M-HP145	30570738
13,000	14	130	22	45	85	80	6	FXR510Ø13.000H7MG1M-HP145	30570739
14,000	14	130	22	45	85	80	6	FXR510Ø14.000H7MG1M-HP145	30570740
15,000	16	130	22	48	82	77	6	FXR510Ø15.000H7MG1M-HP145	30570741
16,000	16	150	25	48	102	97	6	FXR510Ø16.000H7MG1M-HP145	30570742
17,000	18	150	25	48	102	97	8	FXR510Ø17.000H7MG1M-HP145	30570743
18,000	18	150	25	48	102	97	8	FXR510Ø18.000H7MG1M-HP145	30570744
19,000	20	150	25	50	100	95	8	FXR510Ø19.000H7MG1M-HP145	30570745

Wymiary podano w mm.

Zalecane parametry skrawania – patrz koniec rozdziału.

FXR510 | Wersja stała, rowek lewoskrętny

Możliwość konfiguracji parametrów

**Tolerancja średnicy otworu \geq IT6:**

- Możliwość wyboru średnicy w krokach co 0,001 mm
- Dostępne w tolerancji \geq IT6

**Specyfikacja:**

FXR510Ø[średnica][tolerancja]MG1M-HP145

Wariant G:

- Możliwość wyboru średnicy w krokach co 0,001 mm
- Dostępne od tolerancji $\geq 4 \mu\text{m}$ (wariant G – patrz strona 320)

Specyfikacja wariantu G:

FXR510GØ[średnica][tolerancja]MG1M-HP145

Wymiary typoszeregu z możliwością konfiguracji parametrów IT6

d_1	d_2	l_1	l_2	l_3	l_4	l_5	z
2,800 - 3,700	4	65	12	28	37	34	4
3,701 - 4,700	6	75	12	36	39	34	4
4,701 - 6,200	6	75	12	36	39	35	4
6,201 - 7,200	8	100	16	36	64	59	6
7,201 - 8,200	8	100	16	36	64	60	6
8,201 - 9,200	10	100	20	40	60	55	6
9,201 - 10,200	10	120	20	40	80	76	6
10,201 - 11,200	12	120	20	45	75	70	6
11,201 - 12,200	12	120	20	45	75	71	6
12,201 - 14,200	14	130	22	45	85	80	6
14,201 - 15,200	16	130	22	48	82	77	6
15,201 - 16,200	16	150	25	48	102	97	6
16,201 - 18,200	18	150	25	48	102	97	8
18,201 - 20,200	20	150	25	50	100	95	8

Przykład tolerancji \geq IT6:

FXR510Ø16.350H6MG1M-HP145

Średnica otworu $d_1 = 16,350 \text{ H6}$ **Przykład wariantu G:**

FXR510GØ16.350-4MG1M-HP145

Średnica specjalna narzędzia $d_1 = 16,350 -4 \mu\text{m}$

FixReam

Wersja stała, rowek lewoskrętny, do wykonywania otworu przelotowego
FXR510

Wersja:

Średnica rozwiertaka: 2,800 - 20,200 mm
Nakrój: MG1M
Materiał skrawający: HU612
Węglik spiekany bez powłoki

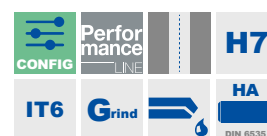
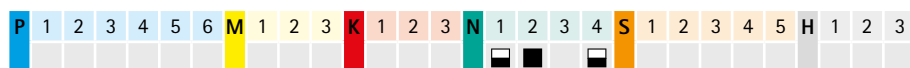
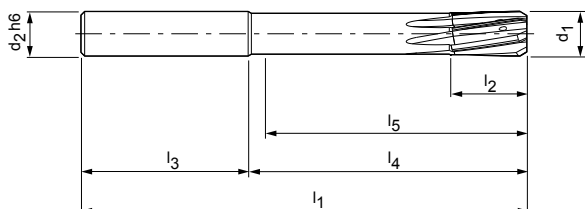

Magazynowa seria preferowana w tolerancji H7

d ₁ H7	Wymiary						z	Specyfikacja	Nr materiałowy
	d ₂ h6	l ₁	l ₂	l ₃	l ₄	l ₅			
4,000	6	75	12	36	39	34	4	FXR510Ø4.000H7MG1M-HU612	30570665
5,000	6	75	12	36	39	35	4	FXR510Ø5.000H7MG1M-HU612	30570667
6,000	6	75	12	36	39	35	4	FXR510Ø6.000H7MG1M-HU612	30570669
7,000	8	100	16	36	64	59	6	FXR510Ø7.000H7MG1M-HU612	30570671
8,000	8	100	16	36	64	60	6	FXR510Ø8.000H7MG1M-HU612	30570673
9,000	10	100	20	40	60	55	6	FXR510Ø9.000H7MG1M-HU612	30570675
10,000	10	120	20	40	80	76	6	FXR510Ø10.000H7MG1M-HU612	30570677
11,000	12	120	20	45	75	70	6	FXR510Ø11.000H7MG1M-HU612	30570679
12,000	12	120	20	45	75	71	6	FXR510Ø12.000H7MG1M-HU612	30570682
13,000	14	130	22	45	85	80	6	FXR510Ø13.000H7MG1M-HU612	30570683
14,000	14	130	22	45	85	80	6	FXR510Ø14.000H7MG1M-HU612	30570684
15,000	16	130	22	48	82	77	6	FXR510Ø15.000H7MG1M-HU612	30570685
16,000	16	150	25	48	102	97	6	FXR510Ø16.000H7MG1M-HU612	30570686
17,000	18	150	25	48	102	97	8	FXR510Ø17.000H7MG1M-HU612	30570687
18,000	18	150	25	48	102	97	8	FXR510Ø18.000H7MG1M-HU612	30570688

Wymiary podano w mm.

Zalecane parametry skrawania – patrz koniec rozdziału.

FXR510 | Wersja stała, rowek lewoskrętny

Możliwość konfiguracji parametrów

**Tolerancja średnicy otworu \geq IT6:**

- Możliwość wyboru średnicy w krokach co 0,001 mm
- Dostępne w tolerancji \geq IT6

**Specyfikacja:**

FXR510Ø[średnica][tolerancja]MG1M-HU612

Wariant G:

- Możliwość wyboru średnicy w krokach co 0,001 mm
- Dostępne od tolerancji $\geq 3 \mu\text{m}$ (wariant G – patrz strona 320)

Specyfikacja wariantu G:

FXR510GØ[średnica][tolerancja]MG1M-HU612

Wymiary typoszeregu z możliwością konfiguracji parametrów IT6

d_1	d_2	l_1	l_2	l_3	l_4	l_5	z
2,800 - 3,700	4	65	12	28	37	34	4
3,701 - 4,700	6	75	12	36	39	34	4
4,701 - 6,200	6	75	12	36	39	35	4
6,201 - 7,200	8	100	16	36	64	59	6
7,201 - 8,200	8	100	16	36	64	60	6
8,201 - 9,200	10	100	20	40	60	55	6
9,201 - 10,200	10	120	20	40	80	76	6
10,201 - 11,200	12	120	20	45	75	70	6
11,201 - 12,200	12	120	20	45	75	71	6
12,201 - 14,200	14	130	22	45	85	80	6
14,201 - 15,200	16	130	22	48	82	77	6
15,201 - 16,200	16	150	25	48	102	97	6
16,201 - 18,200	18	150	25	48	102	97	8
18,201 - 20,200	20	150	25	50	100	95	8

Przykład tolerancji \geq IT6:

FXR510Ø16.350H6MG1M-HU612

Średnica otworu $d_1 = 16,350 \text{ H6}$ **Przykład wariantu G:**

FXR510GØ16.350-3MG1M-HU612

Średnica specjalna narzędzia $d_1 = 16,350 -3 \mu\text{m}$

FixReam

Wersja stała, rowek lewoskrętny, do wykonywania otworu przelotowego
FXR510

Wersja:

Średnica rozwiertaka:

3,701 - 20,200 mm

Nakrój:

MF1M

Materiał skrawający:

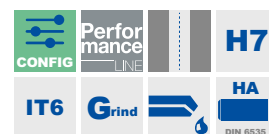
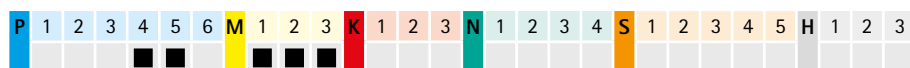
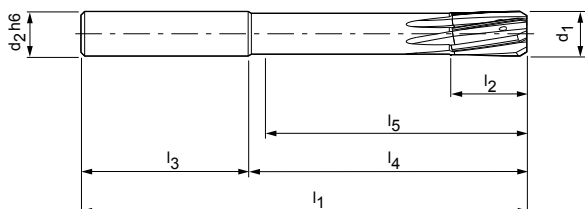
 HP145
Węglik spiekany z
powłoką PVD

Magazynowa seria preferowana w tolerancji H7

d ₁ H7	Wymiary						z	Specyfikacja	Nr materiałowy
	d ₂ h6	l ₁	l ₂	l ₃	l ₄	l ₅			
4,000	6	75	12	36	39	35	4	FXR510Ø4.000H7MF1M-HP145	30570772
5,000	6	75	12	36	39	35	4	FXR510Ø5.000H7MF1M-HP145	30570774
6,000	6	75	12	36	39	35	4	FXR510Ø6.000H7MF1M-HP145	30570776
7,000	8	100	16	36	64	59	6	FXR510Ø7.000H7MF1M-HP145	30570778
8,000	8	100	16	36	64	60	6	FXR510Ø8.000H7MF1M-HP145	30570780
10,000	10	120	20	40	80	76	6	FXR510Ø10.000H7MF1M-HP145	30570784
11,000	12	120	20	45	75	70	6	FXR510Ø11.000H7MF1M-HP145	30570786
12,000	12	120	20	45	75	71	6	FXR510Ø12.000H7MF1M-HP145	30570788
14,000	14	130	22	45	85	80	6	FXR510Ø14.000H7MF1M-HP145	30570790
16,000	16	150	25	48	102	97	6	FXR510Ø16.000H7MF1M-HP145	30570792

Wymiary podano w mm.

Zalecane parametry skrawania – patrz koniec rozdziału.

FXR510 | Wersja stała, rowek lewoskrętny

Możliwość konfiguracji parametrów

**Tolerancja średnicy otworu \geq IT6:**

- Możliwość wyboru średnicy w krokach co 0,001 mm
- Dostępne w tolerancji \geq IT6

**Specyfikacja:**

FXR510Ø[średnica][tolerancja]MF1M-HP145

Wariant G:

- Możliwość wyboru średnicy w krokach co 0,001 mm
- Dostępne od tolerancji $\geq 4 \mu\text{m}$ (wariant G – patrz strona 320)

Specyfikacja wariantu G:

FXR510GØ[średnica][tolerancja]MF1M-HP145

Wymiary typoszeregu z możliwością konfiguracji parametrów IT6

d_1	d_2	l_1	l_2	l_3	l_4	l_5	z
3,701 - 4,700	6	75	12	36	39	34	4
4,701 - 6,200	6	75	12	36	39	35	4
6,201 - 7,200	8	100	16	36	64	59	6
7,201 - 8,200	8	100	16	36	64	60	6
8,201 - 9,200	10	100	20	40	60	55	6
9,201 - 10,200	10	120	20	40	80	76	6
10,201 - 11,200	12	120	20	45	75	70	6
11,201 - 12,200	12	120	20	45	75	71	6
12,201 - 14,200	14	130	22	45	85	80	6
14,201 - 15,200	16	130	22	48	82	77	6
15,201 - 16,200	16	150	25	48	102	97	6
16,201 - 18,200	18	150	25	48	102	97	8
18,201 - 20,200	20	150	25	50	100	95	8

Przykład tolerancji \geq IT6:

FXR510Ø16.350H6MF1M-HP145

Średnica otworu $d_1 = 16,350 \text{ H6}$ **Przykład wariantu G:**

FXR510GØ16.350-4MF1M-HP145

Średnica specjalna narzędzia $d_1 = 16,350 -4 \mu\text{m}$

FixReam

Wersja stała, rowek lewoskrętny, do wykonywania otworu przelotowego
FXR510

Wersja:

Średnica rozwiertaka:

3,701 - 20,200 mm

Nakrój:

MF1M

Materiał skrawający:

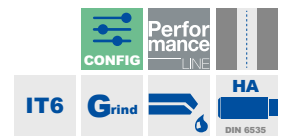
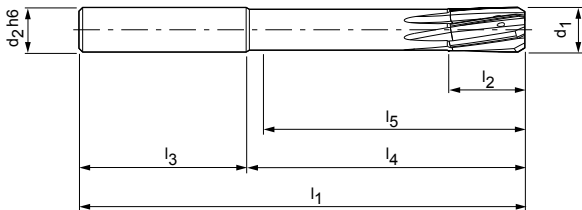
 Węgiel spiekany z
powłoką PVD

Możliwość konfiguracji parametrów

Tolerancja średnicy otworu \geq IT6:

- Możliwość wyboru średnicy w krokach co 0,001 mm
- Dostępne w tolerancji \geq IT6

Specyfikacja:

FXR510Ø[średnica][tolerancja]MF1M-HP625

Wariant G:

- Możliwość wyboru średnicy w krokach co 0,001 mm
- Dostępne od tolerancji \geq 4 μ m (wariant G – patrz strona 320)

Specyfikacja wariantu G:

FXR510GØ[średnica][tolerancja]MF1M-HP625

Wymiary typoszeregu z możliwością konfiguracji parametrów IT6

d_1	d_2	l_1	l_2	l_3	l_4	l_5	z
3,701 - 4,700	6	75	12	36	39	34	4
4,701 - 6,200	6	75	12	36	39	35	4
6,201 - 7,200	8	100	16	36	64	59	6
7,201 - 8,200	8	100	16	36	64	60	6
8,201 - 9,200	10	100	20	40	60	55	6
9,201 - 10,200	10	120	20	40	80	76	6
10,201 - 11,200	12	120	20	45	75	70	6
11,201 - 12,200	12	120	20	45	75	71	6
12,201 - 14,200	14	130	22	45	85	80	6
14,201 - 15,200	16	130	22	48	82	77	6
15,201 - 16,200	16	150	25	48	102	97	6
16,201 - 18,200	18	150	25	48	102	97	8
18,201 - 20,200	20	150	25	50	100	95	8

Przykład tolerancji \geq IT6:

FXR510Ø16.350H6MF1M-HP625

 Średnica otworu $d_1 = 16,350$ H6

Przykład wariantu G:

FXR510GØ16.350-4MF1M-HP625

 Średnica specjalna narzędzia $d_1 = 16,350 - 4 \mu$ m

FixReam

Wersja stała, rowek lewoskrętny, do wykonywania otworu przelotowego
FXR510

Wersja:
Średnica rozwiertaka: 3,701 - 20,200 mm
Nakrój: MF1M
Materiał skrawający: HC614
Węglik spiekany z powłoką CVD

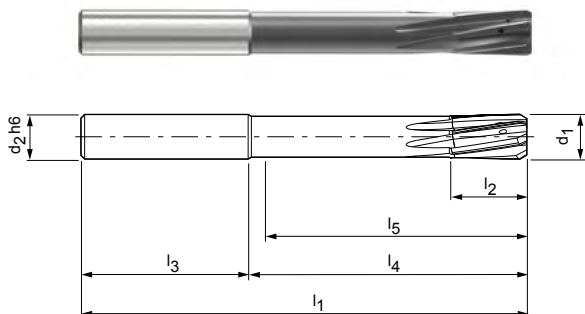

Możliwość konfiguracji parametrów



Tolerancja średnicy otworu \geq IT6:

- Możliwość wyboru średnicy w krokach co 0,001 mm
- Dostępne w tolerancji \geq IT6

Specyfikacja:

FXR510Ø[średnica][tolerancja]MF1M-HC614

Wariant G:

- Możliwość wyboru średnicy w krokach co 0,001 mm
- Dostępne od tolerancji \geq 4 μ m (wariant G – patrz strona 320)

Specyfikacja wariantu G:

FXR510GØ[średnica][tolerancja]MF1M-HC614

Wymiary typoszeregu z możliwością konfiguracji parametrów IT6

d_1	d_2	l_1	l_2	l_3	l_4	l_5	z
3,701 - 4,700	6	75	12	36	39	34	4
4,701 - 6,200	6	75	12	36	39	35	4
6,201 - 7,200	8	100	16	36	64	59	6
7,201 - 8,200	8	100	16	36	64	60	6
8,201 - 9,200	10	100	20	40	60	55	6
9,201 - 10,200	10	120	20	40	80	76	6
10,201 - 11,200	12	120	20	45	75	70	6
11,201 - 12,200	12	120	20	45	75	71	6
12,201 - 14,200	14	130	22	45	85	80	6
14,201 - 15,200	16	130	22	48	82	77	6
15,201 - 16,200	16	150	25	48	102	97	6
16,201 - 18,200	18	150	25	48	102	97	8
18,201 - 20,200	20	150	25	50	100	95	8

Przykład tolerancji \geq IT6:

FXR510Ø16.350H6MF1M-HC614

Średnica otworu $d_1 = 16,350$ H6

Przykład wariantu G:

FXR510GØ16.350-4MF1M-HC614

Średnica specjalna narzędzia $d_1 = 16,350 -4 \mu$ m

FixReam

Wersja monolityczna, prosty rowek wiórowy, do wykonywania otworu przelotowego
FXR500

Wersja:

Średnica rozwiertaka:

3,701 - 20,200 mm

Nakrój:

MG0A

Materiał skrawający:

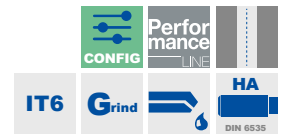
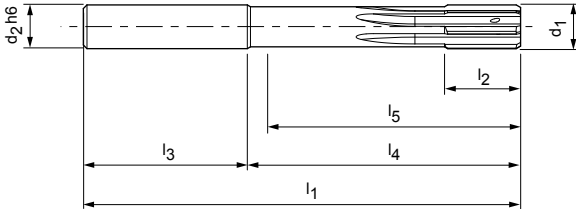
 Węglik spiekany z
powłoką PVD

Możliwość konfiguracji parametrów

Tolerancja średnicy otworu \geq IT6:

- Możliwość wyboru średnicy w krokach co 0,001 mm
- Dostępne w tolerancji \geq IT6

Specyfikacja:

FXR500Ø[średnica][tolerancja]MG0A-HP622

Wariant G:

- Możliwość wyboru średnicy w krokach co 0,001 mm
- Dostępne od tolerancji \geq 4 μ m (wariant G – patrz strona 320)

Specyfikacja wariantu G:

FXR500GØ[średnica][tolerancja]MG0A-HP622

Wymiary typoszeregu z możliwością konfiguracji parametrów IT6

d_1	d_2	l_1	l_2	l_3	l_4	l_5	z
3,701 - 4,700	6	75	12	36	39	34	4
4,701 - 6,200	6	75	12	36	39	35	4
6,201 - 7,200	8	100	16	36	64	59	6
7,201 - 8,200	8	100	16	36	64	60	6
8,201 - 9,200	10	100	20	40	60	55	6
9,201 - 10,200	10	120	20	40	80	76	6
10,201 - 11,200	12	120	20	45	75	70	6
11,201 - 12,200	12	120	20	45	75	71	6
12,201 - 14,200	14	130	22	45	85	80	6
14,201 - 15,200	16	130	22	48	82	77	6
15,201 - 16,200	16	150	25	48	102	97	6
16,201 - 18,200	18	150	25	48	102	97	8
18,201 - 20,200	20	150	25	50	100	95	8

Przykład tolerancji \geq IT6:

FXR500Ø16.350H6MG0A-HP622

 Średnica otworu $d_1 = 16,350$ H6

Przykład wariantu G:

FXR500GØ16.350-4MG0A-HP622

 Średnica specjalna narzędzia $d_1 = 16,350 -4$ μ m

FixReam

Wersja stała, prosty rowek wiórowy, do wykonywania otworu przelotowego
FXR500

Wersja:

Średnica rozwiertaka: 3,701 - 20,200 mm
Nakrój: MF0A
Materiał skrawający: HP141
Węglik spiekany z powłoką PVD

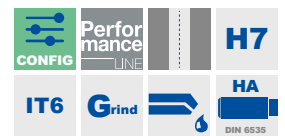
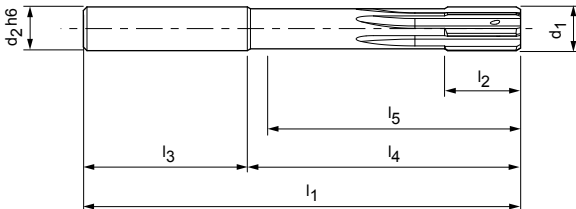

Magazynowa seria preferowana w tolerancji H7

d ₁ H7	Wymiary						z	Specyfikacja	Nr materiałowy
	d ₂ h6	l ₁	l ₂	l ₃	l ₄	l ₅			
5,000	6	75	12	36	39	35	4	FXR500Ø5.000H7MF0A-HP141	30570824
6,000	6	75	12	36	39	35	4	FXR500Ø6.000H7MF0A-HP141	30570826
8,000	8	100	16	36	64	60	6	FXR500Ø8.000H7MF0A-HP141	30570830
10,000	10	120	20	40	80	76	6	FXR500Ø10.000H7MF0A-HP141	30570834
12,000	12	120	20	45	75	71	6	FXR500Ø12.000H7MF0A-HP141	30570838

Możliwość konfiguracji parametrów

Tolerancja średnicy otworu ≥ IT6:

- Możliwość wyboru średnicy w krokach co 0,001 mm
- Dostępne w tolerancji ≥ IT6

Specyfikacja:
FXR500Ø[średnica][tolerancja]MF0A-HP141

Wariant G:

- Możliwość wyboru średnicy w krokach co 0,001 mm
- Dostępne od tolerancji ≥ 5 μm (wariant G – patrz strona 320)

Specyfikacja wariantu G:
FXR500GØ[średnica][tolerancja]MF0A-HP141

Wymiary typoszeregu z możliwością konfiguracji parametrów IT6

d ₁	d ₂	l ₁	l ₂	l ₃	l ₄	l ₅	z
3,701 - 4,700	6	75	12	36	39	34	4
4,701 - 6,200	6	75	12	36	39	35	4
6,201 - 7,200	8	100	16	36	64	59	6
7,201 - 8,200	8	100	16	36	64	60	6
8,201 - 9,200	10	100	20	40	60	55	6
9,201 - 10,200	10	120	20	40	80	76	6
10,201 - 11,200	12	120	20	45	75	70	6
11,201 - 12,200	12	120	20	45	75	71	6
12,201 - 14,200	14	130	22	45	85	80	6
14,201 - 15,200	16	130	22	48	82	77	6
15,201 - 16,200	16	150	25	48	102	97	6
16,201 - 18,200	18	150	25	48	102	97	8
18,201 - 20,200	20	150	25	50	100	95	8

Przykład tolerancji ≥ IT6:

FXR500Ø16.350H6MF0A-HP141

Średnica otworu d₁ = 16,350 H6

Przykład wariantu G:

FXR500GØ16.350-5MF0A-HP141

Średnica specjalna narzędzia d₁ = 16,350 -5 μm

Wymiary podano w mm.

Zalecane parametry skrawania – patrz koniec rozdziału.

FixReam

Wersja monolityczna, prosty rowek wiórowy, do obróbki otworu nieprzelotowego
FXR505

Wersja:

Średnica rozwiertaka: 2,800 - 20,200 mm

Nakrój:

MV0A

Materiał skrawający:

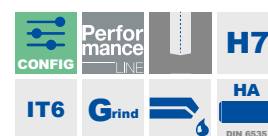
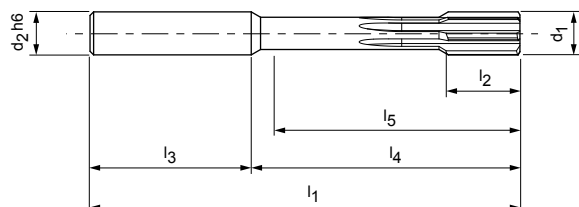
 HP145
Węglik spiekany z
powłoką PVD

Magazynowa seria preferowana w tolerancji H7

d ₁ H7	Wymiary						z	Specyfikacja	Nr materiałowy
	d ₂ h6	l ₁	l ₂	l ₃	l ₄	l ₅			
4,000	6	75	12	36	39	34	4	FXR505Ø4.000H7MV0A-HP145	30570747
5,000	6	75	12	36	39	34	4	FXR505Ø5.000H7MV0A-HP145	30570749
6,000	6	75	12	36	39	34	4	FXR505Ø6.000H7MV0A-HP145	30570751
7,000	8	100	16	36	64	58	6	FXR505Ø7.000H7MV0A-HP145	30570753
8,000	8	100	16	36	64	58	6	FXR505Ø8.000H7MV0A-HP145	30570755
9,000	10	100	20	40	60	54	6	FXR505Ø9.000H7MV0A-HP145	30570757
10,000	10	120	20	40	80	74	6	FXR505Ø10.000H7MV0A-HP145	30570759
11,000	12	120	20	45	75	68	6	FXR505Ø11.000H7MV0A-HP145	30570761
12,000	12	120	20	45	75	68	6	FXR505Ø12.000H7MV0A-HP145	30570763
13,000	14	130	22	45	85	78	6	FXR505Ø13.000H7MV0A-HP145	30570764
14,000	14	130	22	45	85	78	6	FXR505Ø14.000H7MV0A-HP145	30570765
15,000	16	130	22	48	82	75	6	FXR505Ø15.000H7MV0A-HP145	30570766
16,000	16	150	25	48	102	95	6	FXR505Ø16.000H7MV0A-HP145	30570767
17,000	18	150	25	48	102	95	6	FXR505Ø17.000H7MV0A-HP145	30570768
18,000	18	150	25	48	102	95	6	FXR505Ø18.000H7MV0A-HP145	30570769
19,000	20	150	25	50	100	92	6	FXR505Ø19.000H7MV0A-HP145	30570770

Wymiary podano w mm.

Zalecane parametry skrawania – patrz koniec rozdziału.

FXR505 | Wersja stała, prosty rowek wiórowy

Możliwość konfiguracji parametrów

**Tolerancja średnicy otworu \geq IT6:**

- Możliwość wyboru średnicy w krokach co 0,001 mm
- Dostępne w tolerancji \geq IT6

**Specyfikacja:**

FXR505Ø[średnica][tolerancja]MV0A-HP145

Wariant G:

- Możliwość wyboru średnicy w krokach co 0,001 mm
- Dostępne od tolerancji $\geq 4 \mu\text{m}$ (wariant G – patrz strona 320)

Specyfikacja wariantu G:

FXR505GØ[średnica][tolerancja]MV0A-HP145

Wymiary typoszeregu z możliwością konfiguracji parametrów IT6

d_1	d_2	l_1	l_2	l_3	l_4	l_5	z
2,800 - 3,350	4	65	12	37	28	33	4
3,351 - 3,700	4	65	12	28	37	33	4
3,701 - 6,200	6	75	12	36	39	34	4
6,201 - 8,200	8	100	16	36	64	58	6
8,201 - 9,200	10	100	20	40	60	54	6
9,201 - 10,200	10	120	20	40	80	74	6
10,201 - 12,200	12	120	20	45	75	68	6
12,201 - 14,200	14	130	22	45	85	78	6
14,201 - 15,200	16	130	22	48	82	75	6
15,201 - 16,200	16	150	25	48	102	95	6
16,201 - 18,200	18	150	25	48	102	95	6
18,201 - 20,200	20	150	25	50	100	92	6

Przykład tolerancji \geq IT6:

FXR505Ø16.350H6MV0A-HP145

Średnica otworu $d_1 = 16,350 \text{ H6}$ **Przykład wariantu G:**

FXR505GØ16.350-4MV0A-HP145

Średnica specjalna narzędzia $d_1 = 16,350 -4 \mu\text{m}$

FixReam

Wersja stała, prosty rowek wiórowy, do obróbki otworu nieprzelotowego
FXR505

Wersja:

Średnica rozwiertaka: 3,701 - 20,200 mm

Nakrój: HP145

Materiał skrawający:

Węglik spiekany z
powłoką PVD

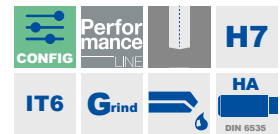
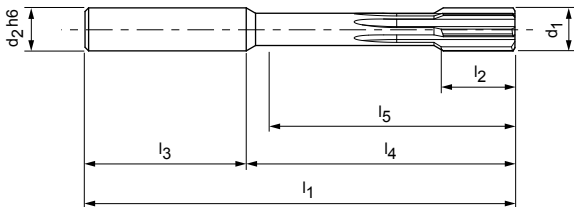

Magazynowa seria preferowana w tolerancji H7

d ₁ H7	Wymiary						z	Specyfikacja	Nr materiałowy
	d ₂ h6	l ₁	l ₂	l ₃	l ₄	l ₅			
4,000	6	75	12	36	39	34	4	FXR505Ø4.000H7MT0A-HP145	30570797
5,000	6	75	12	36	39	34	4	FXR505Ø5.000H7MT0A-HP145	30570799
6,000	6	75	12	36	39	34	4	FXR505Ø6.000H7MT0A-HP145	30570801
8,000	8	100	16	36	64	58	6	FXR505Ø8.000H7MT0A-HP145	30570805
10,000	10	120	20	40	80	74	6	FXR505Ø10.000H7MT0A-HP145	30570809
12,000	12	120	20	45	75	68	6	FXR505Ø12.000H7MT0A-HP145	30570813

Możliwość konfiguracji parametrów

Tolerancja średnicy otworu ≥ IT6:

- Możliwość wyboru średnicy w krokach co 0,001 mm
- Dostępne w tolerancji ≥ IT6

Specyfikacja:

FXR505Ø[średnica][tolerancja]MT0A-HP145

Wariant G:

- Możliwość wyboru średnicy w krokach co 0,001 mm
- Dostępne od tolerancji ≥ 4 μm (wariant G – patrz strona 320)

Specyfikacja wariantu G:

FXR505GØ[średnica][tolerancja]MT0A-HP145

Wymiary typoszeregu z możliwością konfiguracji parametrów IT6

d ₁	d ₂	l ₁	l ₂	l ₃	l ₄	l ₅	z
3,701 - 6,200	6	75	12	36	39	34	4
6,201 - 8,200	8	100	16	36	64	58	6
8,201 - 9,200	10	100	20	40	60	54	6
9,201 - 10,200	10	120	20	40	80	74	6
10,201 - 12,200	12	120	20	45	75	68	6
12,201 - 14,200	14	130	22	45	85	78	6
14,201 - 15,200	16	130	22	48	82	75	6
15,201 - 16,200	16	150	25	48	102	95	6
16,201 - 18,200	18	150	25	48	102	95	6
18,201 - 20,200	20	150	25	50	100	92	6

Przykład tolerancji ≥ IT6:

FXR505Ø16.350H6MT0A-HP145

Średnica otworu d₁ = 16,350 H6

Przykład wariantu G:

FXR505GØ16.350-4MT0A-HP145

Średnica specjalna narzędzia d₁ = 16,350 -4 μm

Wymiary podano w mm.

Zalecane parametry skrawania – patrz koniec rozdziału.

FixReam

Wersja stała, prosty rowek wiórowy, do obróbki otworu nieprzelotowego
FXR505

Wersja:
Średnica rozwiertaka: 3,701 - 20,200 mm
Nakrój: MVOA
Materiał skrawający: HP622
Węglik spiekany z powłoką PVD

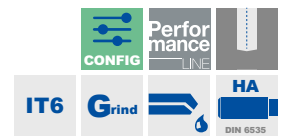
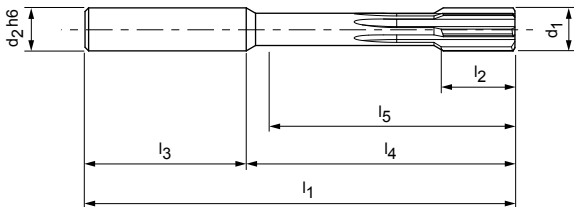

Możliwość konfiguracji parametrów



Tolerancja średnicy otworu \geq IT6:

- Możliwość wyboru średnicy w krokach co 0,001 mm
- Dostępne w tolerancji \geq IT6

Specyfikacja:

FXR505Ø[średnica][tolerancja]MVOA-HP622

Wariant G:

- Możliwość wyboru średnicy w krokach co 0,001 mm
- Dostępne od tolerancji \geq 4 μ m (wariant G – patrz strona 320)

Specyfikacja wariantu G:

FXR505GØ[średnica][tolerancja]MVOA-HP622

Wymiary typoszeregu z możliwością konfiguracji parametrów IT6

d_1	d_2	l_1	l_2	l_3	l_4	l_5	z
3,701 - 6,200	6	75	12	36	39	34	4
6,201 - 8,200	8	100	16	36	64	58	6
8,201 - 9,200	10	100	20	40	60	54	6
9,201 - 10,200	10	120	20	40	80	74	6
10,201 - 12,200	12	120	20	45	75	68	6
12,201 - 14,200	14	130	22	45	85	78	6
14,201 - 15,200	16	130	22	48	82	75	6
15,201 - 16,200	16	150	25	48	102	95	6
16,201 - 18,200	18	150	25	48	102	95	6
18,201 - 20,200	20	150	25	50	100	92	6

Przykład tolerancji \geq IT6:

FXR505Ø16.350H6MVOA-HP622

Średnica otworu $d_1 = 16,350$ H6

Przykład wariantu G:

FXR505GØ16.350-4MVOA-HP622

Średnica specjalna narzędzia $d_1 = 16,350 - 4 \mu$ m

FixReam

Wersja stała, prosty rowek wiórowy, do obróbki otworu nieprzelotowego
FXR505

Wersja:

Średnica rozwiertaka:

2,800 - 20,200 mm

Nakrój:

MV0A

Materiał skrawający:

Węgiel spiekany bez

powłoki

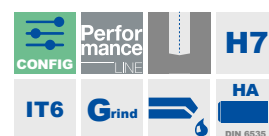
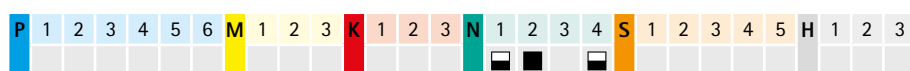
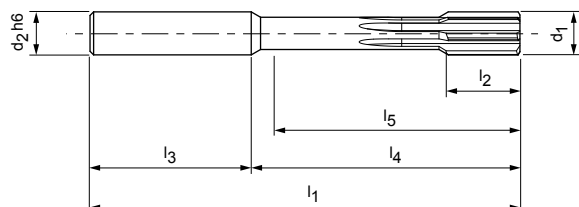

Magazynowa seria preferowana w tolerancji H7

d ₁ H7	Wymiary						z	Specyfikacja	Nr materiałowy
	d ₂ h6	l ₁	l ₂	l ₃	l ₄	l ₅			
4,000	6	75	12	36	39	34	4	FXR505Ø4.000H7MV0A-HU612	30570694
5,000	6	75	12	36	39	34	4	FXR505Ø5.000H7MV0A-HU612	30570696
6,000	6	75	12	36	39	34	4	FXR505Ø6.000H7MV0A-HU612	30570698
7,000	8	100	16	36	64	58	6	FXR505Ø7.000H7MV0A-HU612	30570700
8,000	8	100	16	36	64	58	6	FXR505Ø8.000H7MV0A-HU612	30570702
9,000	10	100	20	40	60	54	6	FXR505Ø9.000H7MV0A-HU612	30570704
10,000	10	120	20	40	80	74	6	FXR505Ø10.000H7MV0A-HU612	30570706
12,000	12	120	20	45	75	68	6	FXR505Ø12.000H7MV0A-HU612	30570710
13,000	14	130	22	45	85	78	6	FXR505Ø13.000H7MV0A-HU612	30570711
14,000	14	130	22	45	85	78	6	FXR505Ø14.000H7MV0A-HU612	30570712
15,000	16	130	22	48	82	75	6	FXR505Ø15.000H7MV0A-HU612	30570713
16,000	16	150	25	48	102	95	6	FXR505Ø16.000H7MV0A-HU612	30570714
18,000	18	150	25	48	102	95	6	FXR505Ø18.000H7MV0A-HU612	30570716
19,000	20	150	25	50	100	92	6	FXR505Ø19.000H7MV0A-HU612	30570717

Wymiary podano w mm.

Zalecane parametry skrawania – patrz koniec rozdziału.

FXR505 | Wersja stała, prosty rowek wiórowy

Możliwość konfiguracji parametrów

**Tolerancja średnicy otworu \geq IT6:**

- Możliwość wyboru średnicy w krokach co 0,001 mm
- Dostępne w tolerancji \geq IT6

**Specyfikacja:**

FXR505Ø[średnica][tolerancja]MV0A-HU612

Wariant G:

- Możliwość wyboru średnicy w krokach co 0,001 mm
- Dostępne od tolerancji $\geq 3 \mu\text{m}$ (wariant G – patrz strona 320)

Specyfikacja wariantu G:

FXR505GØ[średnica][tolerancja]MV0A-HU612

Wymiary typoszeregu z możliwością konfiguracji parametrów IT6

d_1	d_2	l_1	l_2	l_3	l_4	l_5	z
2,800 - 3,350	4	65	12	37	28	33	4
3,351 - 3,700	4	65	12	28	37	33	4
3,701 - 6,200	6	75	12	36	39	34	4
6,201 - 8,200	8	100	16	36	64	58	6
8,201 - 9,200	10	100	20	40	60	54	6
9,201 - 10,200	10	120	20	40	80	74	6
10,201 - 12,200	12	120	20	45	75	68	6
12,201 - 14,200	14	130	22	45	85	78	6
14,201 - 15,200	16	130	22	48	82	75	6
15,201 - 16,200	16	150	25	48	102	95	6
16,201 - 18,200	18	150	25	48	102	95	6
18,201 - 20,200	20	150	25	50	100	92	6

Przykład tolerancji \geq IT6:

FXR505Ø16.350H6MV0A-HU612

Średnica otworu $d_1 = 16,350 \text{ H6}$ **Przykład wariantu G:**

FXR505GØ16.350-3MV0A-HU612

Średnica specjalna narzędzia $d_1 = 16,350 -3 \mu\text{m}$

FixReam

Wersja stała, prosty rowek wiórowy, do obróbki otworu nieprzelotowego
FXR505

Wersja:

Średnica rozwiertaka:

3,701 - 20,200 mm

Nakrój:

MT0A

Materiał skrawający:

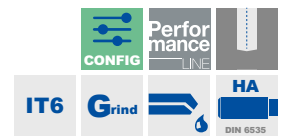
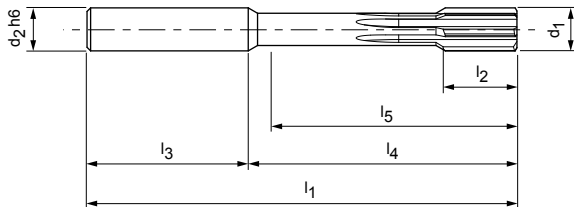
 Węgiel spiekany z
powłoką PVD

Możliwość konfiguracji parametrów

Tolerancja średnicy otworu \geq IT6:

- Możliwość wyboru średnicy w krokach co 0,001 mm
- Dostępne w tolerancji \geq IT6

Specyfikacja:

FXR505Ø[średnica][tolerancja]MT0A-HP625

Wariant G:

- Możliwość wyboru średnicy w krokach co 0,001 mm
- Dostępne od tolerancji \geq 4 μ m (wariant G – patrz strona 320)

Specyfikacja wariantu G:

FXR505GØ[średnica][tolerancja]MT0A-HP625

Wymiary typoszeregu z możliwością konfiguracji parametrów IT6

d_1	d_2	l_1	l_2	l_3	l_4	l_5	z
3,701 - 6,200	6	75	12	36	39	34	4
6,201 - 8,200	8	100	16	36	64	58	6
8,201 - 9,200	10	100	20	40	60	54	6
9,201 - 10,200	10	120	20	40	80	74	6
10,201 - 12,200	12	120	20	45	75	68	6
12,201 - 14,200	14	130	22	45	85	78	6
14,201 - 15,200	16	130	22	48	82	75	6
15,201 - 16,200	16	150	25	48	102	95	6
16,201 - 18,200	18	150	25	48	102	95	6
18,201 - 20,200	20	150	25	50	100	92	6

Przykład tolerancji \geq IT6:

FXR505Ø16.350H6MT0A-HP625

 Średnica otworu $d_1 = 16,350$ H6

Przykład wariantu G:

FXR505GØ16.350-4MT0A-HP625

 Średnica specjalna narzędzia $d_1 = 16,350 - 4 \mu$ m

FixReam

Wersja stała, prosty rowek wiórowy, do obróbki otworu nieprzelotowego
FXR505

Wersja:

Średnica rozwiertaka: 3,701 - 20,200 mm

Nakrój: MVOA

Materiał skrawający: HC614

Węglik spiekany z powłoką CVD

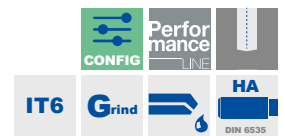
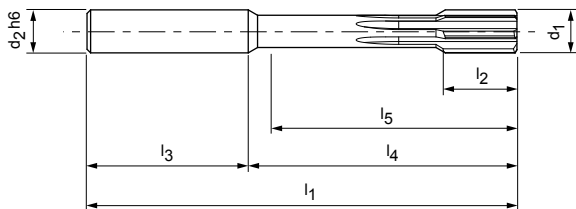

Możliwość konfiguracji parametrów



Tolerancja średnicy otworu \geq IT6:

- Możliwość wyboru średnicy w krokach co 0,001 mm
- Dostępne w tolerancji \geq IT6

Specyfikacja:

FXR505Ø[średnica][tolerancja]MVOA-HC614

Wariant G:

- Możliwość wyboru średnicy w krokach co 0,001 mm
- Dostępne od tolerancji \geq 4 μ m (wariant G – patrz strona 320)

Specyfikacja wariantu G:

FXR505GØ[średnica][tolerancja]MVOA-HC614

Wymiary typoszeregu z możliwością konfiguracji parametrów IT6

d_1	d_2	l_1	l_2	l_3	l_4	l_5	z
3,701 - 6,200	6	75	12	36	39	34	4
6,201 - 8,200	8	100	16	36	64	58	6
8,201 - 9,200	10	100	20	40	60	54	6
9,201 - 10,200	10	120	20	40	80	74	6
10,201 - 12,200	12	120	20	45	75	68	6
12,201 - 14,200	14	130	22	45	85	78	6
14,201 - 15,200	16	130	22	48	82	75	6
15,201 - 16,200	16	150	25	48	102	95	6
16,201 - 18,200	18	150	25	48	102	95	6
18,201 - 20,200	20	150	25	50	100	92	6

Przykład tolerancji \geq IT6:

FXR505Ø16.350H6MVOA-HC614

Średnica otworu $d_1 = 16,350$ H6

Przykład wariantu G:

FXR505GØ16.350-4MVOA-HC614

Średnica specjalna narzędzia $d_1 = 16,350 -4 \mu$ m

FixReam

Wersja stała, prosty rowek wiórowy, do obróbki otworu nieprzelotowego
FXR505

Wersja:

Średnica rozwiertaka:

3,701 - 20,200 mm

Nakrój:

MT0A

Materiał skrawający:

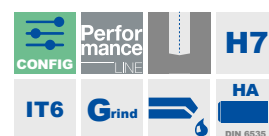
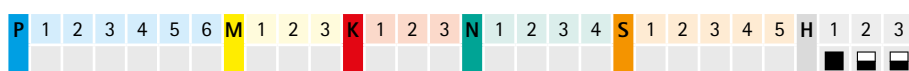
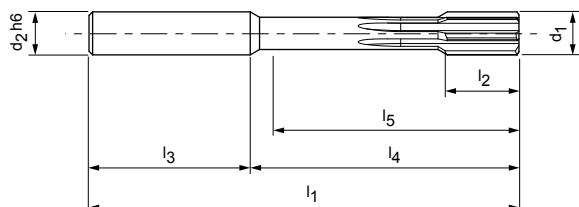
 HP141
Węglik spiekany z
powłoką PVD

Możliwość konfiguracji parametrów

Tolerancja średnicy otworu \geq IT6:

- Możliwość wyboru średnicy w krokach co 0,001 mm
- Dostępne w tolerancji \geq IT6

Specyfikacja:

FXR505Ø[średnica][tolerancja]MT0A-HP141

Wariant G:

- Możliwość wyboru średnicy w krokach co 0,001 mm
- Dostępne od tolerancji \geq 5 μ m (wariant G – patrz strona 320)

Specyfikacja wariantu G:

FXR505GØ[średnica][tolerancja]MT0A-HP141

Wymiary typoszeregu z możliwością konfiguracji parametrów IT6

d_1	d_2	l_1	l_2	l_3	l_4	l_5	z
3,701 - 6,200	6	75	12	36	39	34	4
6,201 - 8,200	8	100	16	36	64	58	6
8,201 - 9,200	10	100	20	40	60	54	6
9,201 - 10,200	10	120	20	40	80	74	6
10,201 - 12,200	12	120	20	45	75	68	6
12,201 - 14,200	14	130	22	45	85	78	6
14,201 - 15,200	16	130	22	48	82	75	6
15,201 - 16,200	16	150	25	48	102	95	6
16,201 - 18,200	18	150	25	48	102	95	6
18,201 - 20,200	20	150	25	50	100	92	6

Przykład tolerancji \geq IT6:

FXR505Ø16.350H6MT0A-HP141

 Średnica otworu $d_1 = 16,350$ H6

Przykład wariantu G:

FXR505GØ16.350-5MT0A-HP141

 Średnica specjalna narzędzia $d_1 = 16,350 -5$ μ m

FixReam

Wersja monolityczna, prosty rowek wiórowy, do obróbki otworu nieprzelotowego
FXR503-short

Wersja:

Średnica rozwiertaka:

2,800 - 20,100 mm

Nakrój:

MC1F

Materiał skrawający:

Węgiel spiekany z

powłoką PVD

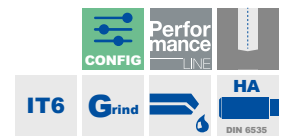
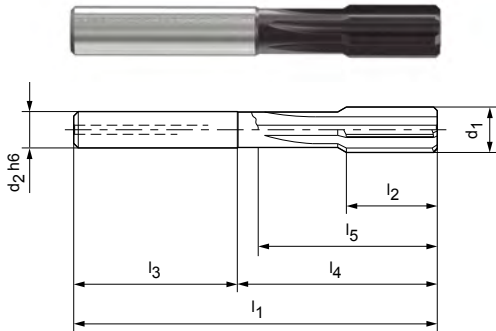
Możliwość konfiguracji parametrów

Tolerancja średnicy otworu \geq IT6:

- Możliwość wyboru średnicy w krokach co 0,001 mm
- Dostępne w tolerancji \geq IT6

Specyfikacja:

FXR503Ø[średnica][tolerancja]MC1F-HP145

Wariant G:

- Możliwość wyboru średnicy w krokach co 0,001 mm
- Dostępne od tolerancji \geq 4 μ m (wariant G – patrz strona 320)

Specyfikacja wariantu G:

FXR503GØ[średnica][tolerancja]MC1F-HP145

Wymiary typoszeregu z możliwością konfiguracji parametrów IT6

d_1	d_2	l_1	l_2	l_3	l_4	l_5	z
2,800 - 4,050	4	56	12	28	28	24	4
4,051 - 5,100	6	64	12	36	28	23	4
5,101 - 5,600	6	64	12	36	28	24	4
6,101 - 6,600	8	75	16	36	39	32	6
6,601 - 7,100	8	75	16	36	39	34	6
7,101 - 8,100	8	75	16	36	39	35	6
8,101 - 10,100	8	75	20	36	39	35	6
10,101 - 11,600	10	80	20	40	40	35	6
11,601 - 13,100	12	90	22	45	45	40	6
13,101 - 15,100	14	90	22	45	45	40	6
15,101 - 18,100	16	100	25	48	52	47	8
18,101 - 20,100	18	100	25	48	52	47	8

Przykład tolerancji \geq IT6:

FXR503Ø16.350H6MC1F-HP145

 Średnica otworu $d_1 = 16,350$ H6

Przykład wariantu G:

FXR503GØ16.350-4MC1F-HP145

 Średnica specjalna narzędzia $d_1 = 16,350 - 4 \mu$ m



Zalecane parametry skrawania dla FixReam FXR

Posuw i prędkość skrawania

FXR510 | FXR505

Materiał skrawający: HP145 | Nakrój: MF1M | MTOA

MZG*	Materiał obrabiany	Wytrzymałość/ twardość [N/mm ²] [HRC]	Prędkość skrawania v _c (m/min)			
			Chłodzenie wewnętrzne	Chłodzenie zewnętrzne	Mgielka	
P	P4.1	Stale nierdzewne, ferrytyczne i martenzytyczne	40	20	30	
	P6.1	Staliwo nierdzewne, ferrytyczne i martenzytyczne	40	20	30	
M	M1.1	Stale nierdzewne, austenityczne	< 700	40	20	30
	M1.2	Stale nierdzewne, ferrytyczne/austenityczne (Duplex)	< 1000	30	15	20
	M2.1	Staliwo nierdzewne, austenityczne	< 700	40	20	30
	M3.1	Staliwo nierdzewne, ferrytyczne/austenityczne (Duplex)	< 1000	30	15	20

FXR510 | FXR505

Materiał skrawający: HP145 | Nakrój: MG1M | MVOA

MZG*	Materiał obrabiany	Wytrzymałość/ twardość [N/mm ²] [HRC]	Prędkość skrawania v _c (m/min)			
			Chłodzenie wewnętrzne	Chłodzenie zewnętrzne	Mgielka	
P	P1.1	Stale konstrukcyjne, użytkowe i uszlachetnione, stale niestopowe	< 700	180	90	150
	P1.2	Stale konstrukcyjne, użytkowe i uszlachetnione, stale niestopowe	< 1200	140	70	115
	P2.1	Stale azotowane, użytkowe i uszlachetnione, stale stopowe	< 900	180	90	150
	P2.2	Stale azotowane, użytkowe i uszlachetnione, stale stopowe	< 1400	140	70	115
	P3.1	Stale narzędziowe, łożyskowe, sprężynowe i stale szybko tnące**	< 800	180	90	150
	P3.2	Stale narzędziowe, łożyskowe, sprężynowe i stale szybko tnące**	< 1000	140	70	110
	P3.3	Stale narzędziowe, łożyskowe, sprężynowe i stale szybko tnące**	< 1500	120	60	90
	P6.1	Staliwo		140	75	100
K	K1.1	Żeliwo z grafitem płatkowym (żeliwo szare), GJL	< 300	120	100	100
	K2.1	Żeliwo sferoidalne, GJS	< 500	150	105	130
	K2.2	Żeliwo sferoidalne, GJS	≤ 800	120	85	98
	K2.3	Żeliwo sferoidalne, GJS	> 800	90	55	70
	K3.1	Żeliwo wermikularne, GJV, (żeliwo ciągliwe), GJL	< 500	90	55	70
	K3.2	Żeliwo wermikularne, GJV, (żeliwo ciągliwe), GJL	> 500	90	55	70

* Grupa materiałowa wg MAPAL

** Jeśli składniki stopu Cr, Mo, Ni, V, W wynoszą łącznie > 8%, należy wybrać następną w kolejności grupę materiałową MAPAL.

	Posuw f_z (mm/z) dla średnicy narzędzia						
	z 4	z 4	z 6	z 6	z 6	z 6	z 8
	< 5,000	> 5,000 - 6,200	> 6,200 - 8,000	> 8,000 - 12,000	> 12,000 - 16,000	> 16,000 - 16,200	> 16,200 - 20,200
	0,020	0,040	0,060	0,080	0,100	0,120	0,120
	0,020	0,040	0,060	0,080	0,100	0,120	0,120
	0,020	0,040	0,060	0,080	0,100	0,120	0,120
	0,020	0,040	0,060	0,080	0,100	0,120	0,120
	0,020	0,040	0,060	0,080	0,100	0,120	0,120
	0,020	0,040	0,060	0,080	0,100	0,120	0,120

	Posuw f_z (mm/z) dla średnicy narzędzia						
	z 4	z 4	z 6	z 6	z 6	z 6	z 8
	< 5,000	> 5,000 - 6,200	> 6,200 - 8,000	> 8,000 - 12,000	> 12,000 - 16,000	> 16,000 - 16,200	> 16,200 - 20,200
	0,050	0,080	0,080	0,140	0,180	0,180	0,190
	0,050	0,080	0,080	0,140	0,180	0,180	0,190
	0,050	0,080	0,080	0,140	0,180	0,180	0,190
	0,050	0,080	0,080	0,140	0,180	0,180	0,190
	0,050	0,080	0,080	0,140	0,180	0,180	0,190
	0,050	0,080	0,080	0,140	0,180	0,180	0,190
	0,050	0,080	0,080	0,140	0,180	0,180	0,190
	0,050	0,080	0,080	0,140	0,180	0,180	0,190
	0,080	0,100	0,100	0,170	0,220	0,220	0,230
	0,080	0,100	0,100	0,170	0,220	0,220	0,230
	0,080	0,100	0,100	0,170	0,220	0,220	0,230
	0,080	0,100	0,100	0,170	0,220	0,220	0,230
	0,080	0,100	0,100	0,170	0,220	0,220	0,230
	0,080	0,100	0,100	0,170	0,220	0,220	0,230

Podane parametry skrawania to wartości orientacyjne.

Optymalne wartości dla danego przypadku obróbki należy ustalić w ramach próby lub podczas obróbki.

Zalecane parametry skrawania dla FixReam FXR

Posuw i prędkość skrawania

FXR503-short

Materiał skrawający: HP145 | Nakrój: MC1F

MZG*	Materiał obrabiany	Wytrzymałość/ twardość [N/mm ²] [HRC]	Prędkość skrawania v _c (m/min)				
			Chłodzenie wewnętrzne	Chłodzenie zewnętrzne	Mgietka		
P	P1	P1.1	Stale konstrukcyjne, użytkowe i uszlachetnione, stale niestopowe	< 700	180	90	150
		P1.2	Stale konstrukcyjne, użytkowe i uszlachetnione, stale niestopowe	< 1200	140	70	115
	P2	P2.1	Stale azotowane, użytkowe i uszlachetnione, stale stopowe	< 900	180	90	150
		P2.2	Stale azotowane, użytkowe i uszlachetnione, stale stopowe	< 1400	140	70	115
	P3	P3.1	Stale narzędziowe, łożyskowe, sprężynowe i stale szybko tnące**	< 800	180	90	150
		P3.2	Stale narzędziowe, łożyskowe, sprężynowe i stale szybko tnące**	< 1000	140	70	110
		P3.3	Stale narzędziowe, łożyskowe, sprężynowe i stale szybko tnące**	< 1500	120	60	90
	P6	P5.1	Staliwo		140	75	100
K	K1	K1.1	Żeliwo z grafitem płatkowym (żeliwo szare), GJL	< 300	120	100	100
		K2.1	Żeliwo sferoidalne, GJS	< 500	150	105	130
	K2	K2.2	Żeliwo sferoidalne, GJS	≤ 800	120	85	98
		K2.3	Żeliwo sferoidalne, GJS	> 800	90	55	70
	K3	K3.1	Żeliwo wermikularne, GJV, (żeliwo ciągliwe), GJL	< 500	90	55	70
		K3.2	Żeliwo wermikularne, GJV, (żeliwo ciągliwe), GJL	> 500	90	55	70

FXR505 | FXR500

Materiał skrawający: HP622 | Nakrój: MVOA | MGOA

MZG*	Materiał obrabiany	Wytrzymałość/ twardość [N/mm ²] [HRC]	Prędkość skrawania v _c (m/min)			
			Chłodzenie wewnętrzne	Chłodzenie zewnętrzne	Mgietka	
N	N1	N1.1	Aluminium, niestopowe i stopowe < 3 % Si	250	125	190
		N1.2	Aluminium, stopowe ≤ 7 % Si	250	125	190
		N1.3	Aluminium, stopowe > 7-12 % Si	250	125	190
		N1.4	Aluminium, stopowe > 12 % Si	250	125	190

FXR505 | FXR510

Materiał skrawający: HU612 | Nakrój: MVOA | MG1M

MZG*	Materiał obrabiany	Wytrzymałość/ twardość [N/mm ²] [HRC]	Prędkość skrawania v _c (m/min)			
			Chłodzenie wewnętrzne	Chłodzenie zewnętrzne	Mgietka	
N2	N2.1	Miedź, niestopowa i niskostopowa	< 300	50	25	
	N2.2	Miedź, stopowa	> 300	50	25	
	N2.3	Mosiądz, brąz, spiż	< 1200	50	25	40

* Grupa materiałowa wg MAPAL

** Jeśli składniki stopu Cr, Mo, Ni, V, W wynoszą łącznie > 8%, należy wybrać następną w kolejności grupę materiałową MAPAL.

	Posuw f_z (mm/z) dla średnicy narzędzia						
	z 4	z 4	z 6	z 6	z 6	z 8	z 8
	< 5,000	> 5,000 - 6,100	> 6,100 - 8,000	> 8,000 - 12,000	> 12,000 - 15,100	> 15,100 - 16,000	> 16,000 - 20,100
	0,050	0,080	0,080	0,140	0,180	0,180	0,190
	0,050	0,080	0,080	0,140	0,180	0,180	0,190
	0,050	0,080	0,080	0,140	0,180	0,180	0,190
	0,050	0,080	0,080	0,140	0,180	0,180	0,190
	0,050	0,080	0,080	0,140	0,180	0,180	0,190
	0,050	0,080	0,080	0,140	0,180	0,180	0,190
	0,050	0,080	0,080	0,140	0,180	0,180	0,190
	0,050	0,080	0,080	0,140	0,180	0,180	0,190
	0,08	0,10	0,10	0,17	0,22	0,22	0,23
	0,08	0,10	0,10	0,17	0,22	0,22	0,23
	0,08	0,10	0,10	0,17	0,22	0,22	0,23
	0,08	0,10	0,10	0,17	0,22	0,22	0,23
	0,08	0,10	0,10	0,17	0,22	0,22	0,23
	0,08	0,10	0,10	0,17	0,22	0,22	0,23

	Posuw f_z (mm/z) dla średnicy narzędzia						
	z 4	z 4	z 6	z 6	z 6	z 6	z 6
	< 5,000	> 5,000 - 6,200	> 6,200 - 8,000	> 8,000 - 12,000	> 12,000 - 16,000	> 16,000 - 16,200	> 16,200 - 20,200
	0,120	0,150	0,150	0,210	0,250	0,250	0,300
	0,120	0,150	0,150	0,210	0,250	0,250	0,300
	0,120	0,150	0,150	0,210	0,250	0,250	0,300
	0,120	0,150	0,150	0,210	0,250	0,250	0,300

	Posuw f_z (mm/z) dla średnicy narzędzia						
	z 4	z 4	z 6	z 6	z 6	z 6	z 8
	< 5,000	> 5,000 - 6,200	> 6,200 - 8,000	> 8,000 - 12,000	> 12,000 - 16,000	> 16,000 - 16,200	> 16,200 - 20,200
	0,040	0,050	0,050	0,060	0,100	0,100	0,100
	0,040	0,050	0,050	0,060	0,100	0,100	0,100
	0,040	0,050	0,050	0,060	0,100	0,100	0,100

Podane parametry skrawania to wartości orientacyjne.
 Optymalne wartości dla danego przypadku obróbki należy ustalić w ramach próby lub podczas obróbki.

Zalecane parametry skrawania dla FixReam FXR

Posuw i prędkość skrawania

FXR510 | FXR505

Materiał skrawający: HP625 | Nakrój: MF1M | MTOA

MZG*	Materiał obrabiany	Wytrzymałość/ twardość [N/mm ²] [HRC]	Prędkość skrawania v _c (m/min)			
			Chłodzenie wewnętrzne	Chłodzenie zewnętrzne	Mgiewka	
S	S1 S1.1	Tytan, stopy tytanu	< 400	25	10	15
	S2 S2.1	Tytan, stopy tytanu	< 1200	25	10	15
	S2 S2.2	Tytan, stopy tytanu	> 1200	25	10	15
	S3 S3.1	Nikiel, niestopowy i stopowy	< 900	25	10	15
	S3 S3.2	Nikiel, niestopowy i stopowy	> 900	25	10	15
	S4 S4.1	Nadstop o wysokiej odporności termicznej na bazie Ni, Co i Fe		25	10	15
	S5 S5.1	Stopy wolframu i molibdenu		25	10	15

FXR510 | FXR505

Materiał skrawający: HC614 | Nakrój: MF1M | MVOA

MZG*	Materiał obrabiany	Wytrzymałość/ twardość [N/mm ²] [HRC]	Prędkość skrawania v _c (m/min)			
			Chłodzenie wewnętrzne	Chłodzenie zewnętrzne	Mgiewka	
C	C1 C1.1	Matryca z tworzywa sztucznego, wzmocnionego włóknem aramidowym (AFK)		50	25	30
	C1 C1.2	Matryca z tworzywa sztucznego (duroplastycznego), CFK/GFK		50	25	30
	C1 C1.3	Matryca z tworzywa sztucznego (termoplastycznego), CFK/GFK		50	25	30

FXR500 | FXR505

Materiał skrawający: HP141 | Nakrój: MFOA | MTOA

MZG*	Materiał obrabiany	Wytrzymałość/ twardość [N/mm ²] [HRC]	Prędkość skrawania v _c (m/min)			
			Chłodzenie wewnętrzne	Chłodzenie zewnętrzne	Mgiewka	
H	H1 H1.1	Stal utwardzana/staliwo	< 44	50	20	30
	H1 H1.2	Stal utwardzana/staliwo	< 55	10	5	5

	Posuw f_z (mm/z) dla średnicy narzędzia						
	z 4	z 4	z 6	z 6	z 6	z 6	z 8
	< 5,000	> 5,000 - 6,200	> 6,200 - 8,000	> 8,000 - 12,000	> 12,000 - 16,000	> 16,000 - 16,200	> 16,200 - 20,200
	0,020	0,040	0,060	0,080	0,100	0,100	0,100
	0,020	0,040	0,060	0,080	0,100	0,100	0,100
	0,020	0,040	0,060	0,080	0,100	0,100	0,100
	0,020	0,040	0,060	0,080	0,100	0,100	0,100
	0,020	0,040	0,060	0,080	0,100	0,100	0,100
	0,020	0,040	0,060	0,080	0,100	0,100	0,100
	0,020	0,040	0,060	0,080	0,100	0,100	0,100

	Posuw f_z (mm/z) dla średnicy narzędzia						
	z 4	z 4	z 6	z 6	z 6	z 6	z 8
	< 5,000	> 5,000 - 6,200	> 6,200 - 8,000	> 8,000 - 12,000	> 12,000 - 16,000	> 16,000 - 16,200	> 16,200 - 20,200
	0,060	0,100	0,100	0,100	0,100	0,100	0,100
	0,060	0,100	0,100	0,100	0,100	0,100	0,100
	0,060	0,100	0,100	0,100	0,100	0,100	0,100

	Posuw f_z (mm/z) dla średnicy narzędzia						
	z 4	z 4	z 6	z 6	z 6	z 6	z 6
	< 5,000	> 5,000 - 6,200	> 6,200 - 8,000	> 8,000 - 12,000	> 12,000 - 16,000	> 16,000 - 16,200	> 16,200 - 20,200
	0,015	0,025	0,020	0,040	0,050	0,050	0,050
	0,015	0,025	0,020	0,040	0,050	0,050	0,050

Podane parametry skrawania to wartości orientacyjne.

Optymalne wartości dla danego przypadku obróbki należy ustalić w ramach próby lub podczas obróbki.

PRZEGLĄD PRODUKTÓW





















Typoszereg MonoReam 700

Rozwiertaki wielostrzowe z typoszeregu MonoReam 700 to nowy, prosty, wydajny i znormalizowany system rozwiercania. Rozwiertaki typoszeregu MonoReam są dostępne w wersji rozszerzanej. W zależności od zakresu zastosowania i obrabianego materiału są one dostępne w wersjach z rowkiem lewo- lub prostoskrętnym, do obróbki otworów przelotowych i nieprzelotowych oraz z różnymi kształtami nakroju i z różnych materiałów skrawających.

MonoReam Plus

Typoszereg MonoReam Plus został zaprojektowany pod kątem obróbki żeliwa i stali. Rozwiertaki z tego typoszeregu wyposażone są w innowacyjny i opatentowany system doprowadzenia chłodziwa. Ponadto tuleja zapewnia optymalne doprowadzenie chłodziwa do ostrzy HPC.

Program do otworów przelotowych i nieprzelotowych nadaje się idealnie do obróbki w zakresie średnicy od 3,850 do 8,200 mm.

MonoReam			
			
<p>MonoReam 700 Wersja z prostym rowkiem wiórowym do obróbki otworów przelotowych w metalach nieżelaznych za pomocą ostrzy z niepowlekanego węgla spiekanego (ostrza PCD dostępne na zapytanie).</p> <p>Zakres \varnothing: 7,700-40,200 mm*</p> <p>   </p> <p></p>	<p>MonoReam 710 Wersja z rowkiem lewoskrętnym do obróbki otworów przelotowych za pomocą ostrzy z niepowlekanego lub powlekanego węgla spiekanego.</p> <p>Zakres \varnothing: 7,700-40,200 mm*</p> <p>   </p> <p> </p>	<p>MonoReam 705 Wersja z prostym rowkiem wiórowym do obróbki otworów nieprzelotowych za pomocą ostrzy z niepowlekanego lub powlekanego węgla spiekanego. (cięcie PCD na życzenie).</p> <p>Zakres \varnothing: 7,700-40,200 mm*</p> <p>   </p> <p>  </p>	
Strona 358	Strona 356	Strona 359	

* Zakres średnicy może się różnić w zależności od typoszeregu.



Objaśnienia do typoszeregu 700

Rozwiertaki MonoReam typoszeregu 700 są używane jako narzędzia stałe, ale ten typoszereg jest zoptymalizowany pod kątem ponownego szlifowania. Do rozszerzania średnicy rozwiertaka służy jednocześnie śruba rozprężna. System rozszerzania nadaje się tylko do kompensacji przed ponownym szlifowaniem, a nie do pierwszej lub ponownej regulacji średnicy. Dzięki rozszerzeniu średnicy możliwe jest szlifowanie wszystkich powierzchni funkcyjnych, zarówno w obrębie nakroju, jak i średnicy narzędzia.

MonoReam Plus



MonoReam Plus | MRP510 Głowica z cermetu

Rozwiertak wysoko wydajny z głowicą z cermetu, rowek lewoskrętny,

Zakres \varnothing : 3,850 - 8,200 mm



Strona 362



MonoReam Plus | MRP505 Głowica z cermetu

Rozwiertak wysoko wydajny z głowicą z cermetu, prosty rowek wiórowy,

Zakres \varnothing : 3,850 - 8,200 mm



Strona 363

Zestawienie rozwiertaków MonoReam | MonoReam Plus (1/2)

Klasa produktu	Rodzaj otworu	Grupa materiałowa											
		P					K					N	
		1-2	3.1	3.2	3.3	4-6	1	2.1	2.2	2.3	K3	1-2	4
Performance		■	■	■			■	■	■	■			
		■	■	■	■	■	■	■	■	■	■		
												■	■
		■	■	■			■	■	■	■			
		■	■	■	■	■	■	■	■	■	■		
												■	■
		■	■	■			■	■					
		■	■	■			■	■					

Przykład zamówienia:

Typszereg MonoReam Plus

M R P

MonoReam Plus

5 1 0

Kąt pochylenia ostrza
ostrzy:
0 = prosty rowek wiórowy
1 = rowek lewoskrętny

Wersje:

5 = rozwiertak stały, głowica z cermetu

Średnica

∅ 0 7

Rodzaj otworu:
0 = otwór przelotowy
5 = otwór nieprzelotowy

Średnica otworu

. 5 0 0

Tolerancja

- 3

Tolerancja IT lub wymiary w μm (przykład: +30+10) lub dla wariantu G tolerancja produkcyjna średnicy szlifowania narzędzia, np. -3 μm

Przykład zamówienia:

Typszereg MonoReam

M O R

MonoReam

7 0 0

Wersje:
7 = rozwiertak rozszerzany

Kąt pochylenia ostrza:
0 = prosty rowek wiórowy
1 = rowek lewoskrętny

Średnica

∅ 2 0

Rodzaj otworu:
0 = otwór przelotowy
5 = otwór nieprzelotowy

Średnica otworu

. 0 0 0

Tolerancja

- 3

Tolerancja IT lub wymiary w μm (przykład: +30+10) lub dla wariantu G tolerancja produkcyjna średnicy szlifowania narzędzia, np. -3 μm

Krok 1:
Klasa produktu



Krok 2:
Rodzaj otworu



Krok 3:
Grupa materiałowa





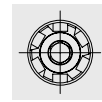











Krok 4:
Wersja



Krok 5:
Wstępnie skonfigurowane
średnice lub konfiguracja

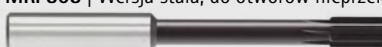

	Wersja					Wstępnie skonfigurowane średnice		Konfiguracja
	d ₁	Materiał skrawający	Nacięcie	 stałe	 rozszerzane	Typoszereg	Strona	
	7,700 - 40,200	CU130	MY1G			MOR710	356	MOR710 Wersja rozszerzana, do wykonywania otworów przelotowych 
	7,700 - 40,200	HP421	MY1G			MOR710	357	
	7,700 - 40,200	HU612	MY1G			MOR700	358	MOR700 
	7,700 - 40,200	CU130	MU2A			MOR705	359	MOR705 Wersja rozszerzana, do otworów nieprzelotowych 
	7,700 - 40,200	HP421	MU2A			MOR705	360	
	7,700 - 40,200	HU612	MU2A			MOR705	361	
	3,850 - 8,200	CU178	MG1M			MRP510	362	MRP510 Wersja stała, do wykonywania otworów przelotowych 
	3,850 - 8,200	CU178	MV3C			MRP505	363	MRP505 Wersja stała, do otworów nieprzelotowych 

Nakrój [Lead]

Materiał skrawający [Cut]

M G 1 M

–

C U 1 7 8

Typ nakroju i kąt natarcia:
MG1M
MV3C

Wyjaśnienie geometrii nakroju – patrz strona 752.

Materiał skrawający:
CU178

Nakrój [Lead]

Materiał skrawający [Cut]

M Y 1 G

–

C P 1 3 6

Typ nakroju i kąt natarcia:
MY1G
MU2A

Wyjaśnienie geometrii nakroju – patrz strona 752.

Materiał skrawający:
HP421
HU612
CU130
PCD i na życzenie

Zestawienie rozwiertaków MonoReam | Konfiguracja MonoReam Plus (2/2)

MOR710

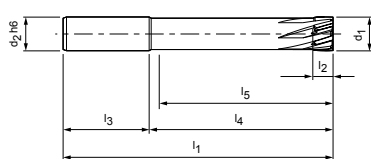

MOR700

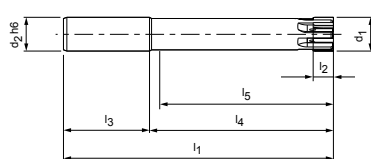

MOR705

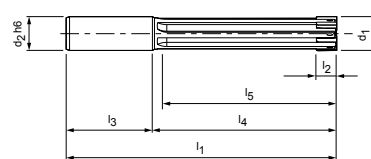

Wymiary narzędzia

MOR710 | MOR700

d_1	d_2	l_1	l_2	l_3	l_4	l_5	z
7,700 - 9,700	12	120	8	45	75	70	4
9,701 - 11,700	12	120	8	45	75	70	6
11,701 - 17,200	16	140	8	48	92	87	6
17,201 - 22,200	20	160	12	50	110	105	6
22,201 - 27,200	20	180	12	50	130	125	6
27,201 - 29,200	25	200	12	56	144	139	6
29,201 - 40,200	25	200	12	56	144	139	8

MOR705

d_1	d_2	l_1	l_2	l_3	l_4	l_5	z
7,700 - 9,700	12	120	8	45	75	64	4
9,701 - 11,700	12	120	8	45	75	65	6
11,701 - 17,200	16	140	8	48	92	80	6
17,201 - 18,200	20	160	12	50	110	98	6
18,201 - 19,200	20	160	12	50	110	99	6
19,201 - 22,200	20	160	12	50	110	100	6
22,201 - 27,200	20	180	12	50	130	120	6
27,201 - 29,200	25	200	12	56	144	130	6
29,201 - 40,200	25	200	12	56	144	130	8



MRP510

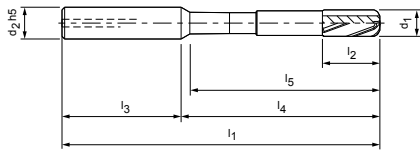

MRP505

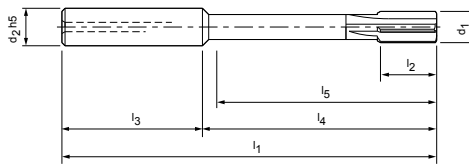

Wymiary narzędzia

MRP510

d ₁	d ₂	l ₁	l ₂	l ₃	l ₄	l ₅	z
3,850 - 4,900	10	80	14	40	40	33	4
4,901 - 6,200	12	85	14	45	40	33	4
6,201 - 6,700	12	105	14	45	60	52	6
6,701 - 8,200	12	110	18	45	65	57	6

MRP505

d ₁	d ₂	l ₁	l ₂	l ₃	l ₄	l ₅	z
3,850 - 4,900	10	80	12	40	40	33	4
4,901 - 6,200	12	85	12	45	40	33	4
6,201 - 6,700	12	105	12	45	60	53	6
6,701 - 8,200	12	110	16	45	65	58	6

Tolerancje dla wariantu G/wariantu stałego MOR7XX | MRP5XX:

Materiał skrawający	Zakres średnicy
	Ø 7,700-40,200
Bez powłoki	-0,003
CU130	
HU612	
CU178	
Z powłoką (grubość powłoki 1-2 µm)	-0,004
HP421	
CP136	

Wyjaśnienie – wariant G MOR | MRP

Dopuszczalne tolerancje obrabianego przedmiotu przy wyborze średnicy narzędzia

Wersja „wariant G”:

Wariant G wskazuje średnicę narzędzia rozwiertaka z naszymi tolerancjami produkcyjnymi. Tolerancje produkcyjne zależą od materiału skrawającego. Patrz najmniejsze dopuszczalne tolerancje dla wariantu G.

MonoReam

Wersja rozprężna, do wykonywania otworów przelotowych
MOR710

Wersja:

Średnica rozwiertaka:

7,700 - 40,200 mm

Nakrój:

MY1G

Materiał skrawający:

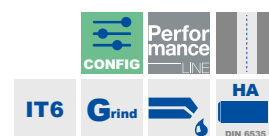
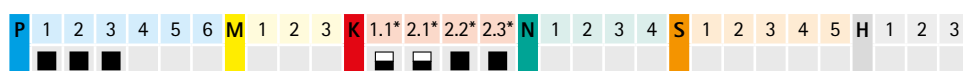
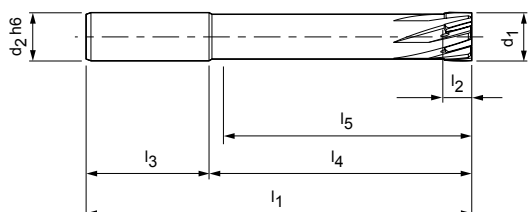
 CU130
Cermet bez powłoki

Możliwość konfiguracji parametrów

Tolerancja średnicy otworu \geq IT6:

- Możliwość wyboru średnicy w krokach co 0,001 mm
- Dostępne w tolerancji \geq IT6

Specyfikacja:

MOR710Ø[średnica][tolerancja]MY1G-CU130

Wariant G:

- Możliwość wyboru średnicy w krokach co 0,001 mm
- Dostępne od tolerancji \geq 3 μ m (wariant G – patrz strona 355)

Specyfikacja wariantu G:

MOR710GØ[średnica][tolerancja]MY1G-CU130

Wymiary typoszeregu z możliwością konfiguracji parametrów IT6

d_1	d_2	l_1	l_2	l_3	l_4	l_5	z
7,700 - 9,700	12	120	8	45	75	70	4
9,701 - 11,700	12	120	8	45	75	70	6
11,701 - 17,200	16	140	8	48	92	87	6
17,201 - 22,200	20	160	12	50	110	105	6
22,201 - 27,200	20	180	12	50	130	125	6
27,201 - 29,200	25	200	12	56	144	139	6
29,201 - 40,200	25	200	12	56	144	139	8

Przykład tolerancji \geq IT6:

MOR710Ø16.350H6MY1G-CU130

 Średnica otworu $d_1 = 16,350$ H6

Przykład wariantu G:

MOR710GØ16.350-3MY1G-CU130

 Średnica specjalna narzędzia $d_1 = 16,350 -3 \mu$ m

Wymiary podano w mm.

 * do powierzchni $R_a < 2 \mu$ m

Zalecane parametry skrawania – patrz koniec rozdziału.

MonoReam

Wersja rozszerzana, do wykonywania otworów przelotowych MOR710

Wersja:
 Średnica rozwiertaka: 7,700 - 40,200 mm
 MY1G
 Nakrój: HP421
 Materiał skrawający: Węglik spiekany z powłoką PVD

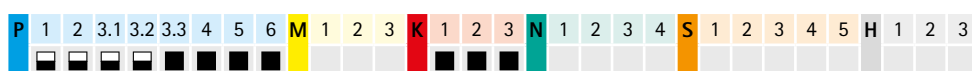
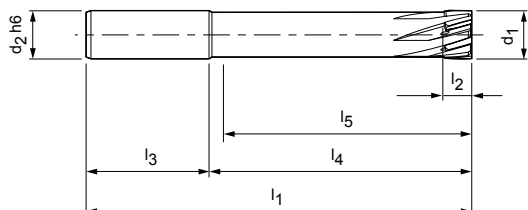

Możliwość konfiguracji parametrów



Tolerancja średnicy otworu \geq IT6:

- Możliwość wyboru średnicy w krokach co 0,001 mm
- Dostępne w tolerancji \geq IT6

Specyfikacja:

MOR710Ø[średnica][tolerancja]MY1G-HP421

Wariant G:

- Możliwość wyboru średnicy w krokach co 0,001 mm
- Dostępne od tolerancji \geq 4 μ m (wariant G – patrz strona 355)

Specyfikacja wariantu G:

MOR710GØ16.350-4[średnica][tolerancja]MY1G-HP421

Wymiary typoszeregu z możliwością konfiguracji parametrów IT6

d_1	d_2	l_1	l_2	l_3	l_4	l_5	z
7,700 - 9,700	12	120	8	45	75	70	4
9,701 - 11,700	12	120	8	45	75	70	6
11,701 - 17,200	16	140	8	48	92	87	6
17,201 - 22,200	20	160	12	50	110	105	6
22,201 - 27,200	20	180	12	50	130	125	6
27,201 - 29,200	25	200	12	56	144	139	6
29,201 - 40,200	25	200	12	56	144	139	8

Przykład tolerancji \geq IT6:

MOR710Ø16.350H6MY1G-HP421

Średnica otworu $d_1 = 16,350$ H6

Przykład wariantu G:

MOR710GØ16.350-4MY1G-HP421

Średnica specjalna narzędzia $d_1 = 16,350 -4 \mu$ m

MonoReam

Wersja rozprężna, do wykonywania otworów przelotowych
MOR700

Wersja:

Średnica rozwiertaka: 7,700 - 40,200 mm

Nakrój: MY1G

Materiał skrawający: HU612
Węglik spiekany bez powłoki

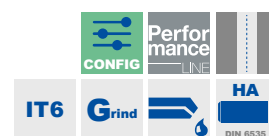
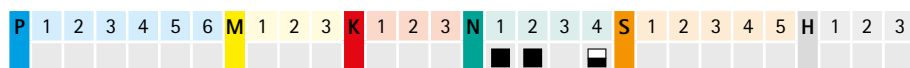
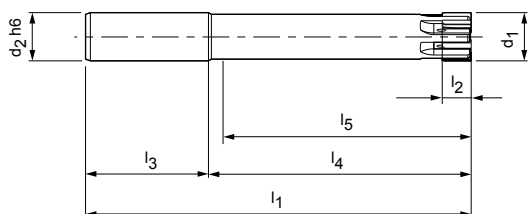

Możliwość konfiguracji parametrów

Tolerancja średnicy otworu \geq IT6:

- Możliwość wyboru średnicy w krokach co 0,001 mm
- Dostępne w tolerancji \geq IT6

Specyfikacja:

MOR700Ø[średnica][tolerancja]MY1G-HU612

Wariant G:

- Możliwość wyboru średnicy w krokach co 0,001 mm
- Dostępne od tolerancji \geq 3 μ m (wariant G – patrz strona 355)

Specyfikacja wariantu G:

MOR700GØ[średnica][tolerancja]MY1G-HU612

Wymiary typoszeregu z możliwością konfiguracji parametrów IT6

d_1	d_2	l_1	l_2	l_3	l_4	l_5	z
7,700 - 9,700	12	120	8	45	75	70	4
9,701 - 11,700	12	120	8	45	75	70	6
11,701 - 17,200	16	140	8	48	92	87	6
17,201 - 22,200	20	160	12	50	110	105	6
22,201 - 27,200	20	180	12	50	130	125	6
27,201 - 29,200	25	200	12	56	144	139	6
29,201 - 40,200	25	200	12	56	144	139	8

Przykład tolerancji \geq IT6:

MOR700Ø16.350H6MY1G-HU612

Średnica otworu $d_1 = 16,350$ H6

Przykład wariantu G:

MOR700GØ16.350-3MY1G-HU612

Średnica specjalna narzędzia $d_1 = 16,350 -3 \mu$ m

MonoReam

Wersja rozprężna, prosty rowek wiórowy, do obróbki otworu nieprzewodzącego MOR705

Wersja:
 Średnica rozwiertaka: 7,700 - 40,200 mm
 Nakrój: MU2A
 Materiał skrawający: CU130
 Cermet bez powłoki

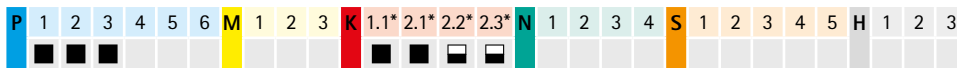
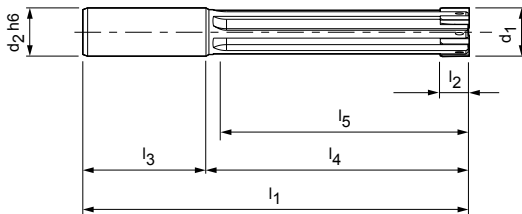

Możliwość konfiguracji parametrów



Tolerancja średnicy otworu \geq IT6:

- Możliwość wyboru średnicy w krokach co 0,001 mm
- Dostępne w tolerancji \geq IT6

Specyfikacja:

MOR705Ø[średnica][tolerancja]MU2A-CU130

Wariant G:

- Możliwość wyboru średnicy w krokach co 0,001 mm
- Dostępne od tolerancji \geq 3 μ m (wariant G – patrz strona 355)

Specyfikacja wariantu G:

MOR705GØ[średnica][tolerancja]MU2A-CU130

Wymiary typoszeregu z możliwością konfiguracji parametrów IT6

d_1	d_2	l_1	l_2	l_3	l_4	l_5	z
7,700 - 9,700	12	120	8	45	75	64	4
9,701 - 11,700	12	120	8	45	75	65	6
11,701 - 17,200	16	140	8	48	92	80	6
17,201 - 18,200	20	160	12	50	110	98	6
18,201 - 19,200	20	160	12	50	110	99	6
19,201 - 22,200	20	160	12	50	110	100	6
22,201 - 27,200	20	180	12	50	130	120	6
27,201 - 29,200	25	200	12	56	144	130	6
29,201 - 40,200	25	200	12	56	144	130	8

Przykład tolerancji \geq IT6:

MOR705Ø16.350H6MU2A-CU130

Średnica otworu $d_1 = 16,350$ H6

Przykład wariantu G:

MOR705GØ16.350-3MU2A-CU130

Średnica specjalna narzędzia $d_1 = 16,350 -3 \mu$ m

Wymiary podano w mm.

* do powierzchni $R_a < 2 \mu$ m

Zalecane parametry skrawania – patrz koniec rozdziału.

MonoReam

Wersja rozszerzana, prosty rowek wiórowy, do obróbki otworu nieprzelotowego MOR705

Wersja:

Średnica rozwiertaka:

7,700 - 40,200 mm

Nakrój:

MU2A

Materiał skrawający:

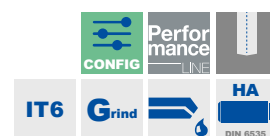
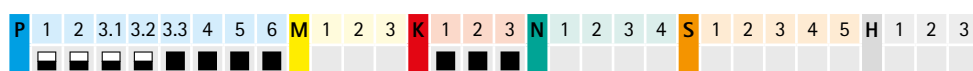
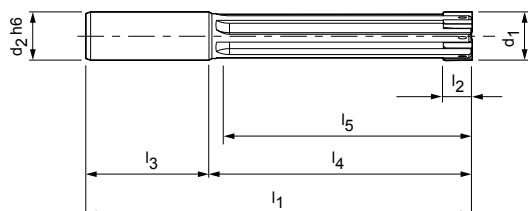
 HP421
 Węgiel spiekany z
 powłoką PVD

Możliwość konfiguracji parametrów

Tolerancja średnicy otworu \geq IT6:

- Możliwość wyboru średnicy w krokach co 0,001 mm
- Dostępne w tolerancji \geq IT6

Specyfikacja:

MOR705Ø[średnica][tolerancja]MU2A-HP421

Wariant G:

- Możliwość wyboru średnicy w krokach co 0,001 mm
- Dostępne od tolerancji \geq 4 μ m (wariant G – patrz strona 355)

Specyfikacja wariantu G:

MOR705GØ[średnica][tolerancja]MU2A-HP421

Wymiary typoszeregu z możliwością konfiguracji parametrów IT6

d_1	d_2	l_1	l_2	l_3	l_4	l_5	z
7,700 - 9,700	12	120	8	45	75	64	4
9,701 - 11,700	12	120	8	45	75	65	6
11,701 - 17,200	16	140	8	48	92	80	6
17,201 - 18,200	20	160	12	50	110	98	6
18,201 - 19,200	20	160	12	50	110	99	6
19,201 - 22,200	20	160	12	50	110	100	6
22,201 - 27,200	20	180	12	50	130	120	6
27,201 - 29,200	25	200	12	56	144	130	6
29,201 - 40,200	25	200	12	56	144	130	8

Przykład tolerancji \geq IT6:

MOR705Ø16.350H6MU2A-HP421

 Średnica otworu $d_1 = 16,350$ H6

Przykład wariantu G:

MOR705GØ16.350-4MU2A-HP421

 Średnica specjalna narzędzia $d_1 = 16,350 -4 \mu$ m

MonoReam

Wersja rozszerzana, prosty rowek wiórowy, do obróbki otworu nieprzelotowego MOR705

Wersja:

Średnica rozwiertaka: 7,700 - 40,200 mm
 Nakrój: MU2A
 Materiał skrawający: Węgiel spiekany bez powłoki

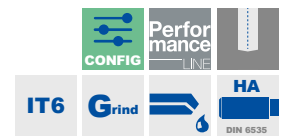
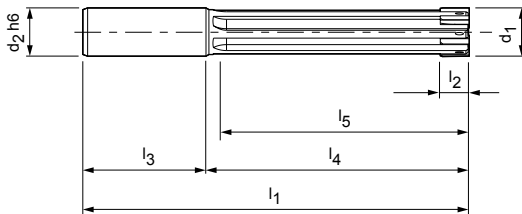

Możliwość konfiguracji parametrów



Tolerancja średnicy otworu \geq IT6:

- Możliwość wyboru średnicy w krokach co 0,001 mm
- Dostępne w tolerancji \geq IT6

Specyfikacja:

MOR705Ø[średnica][tolerancja]MU2A-HU612

Wariant G:

- Możliwość wyboru średnicy w krokach co 0,001 mm
- Dostępne od tolerancji \geq 3 μ m (wariant G – patrz strona 355)

Specyfikacja wariantu G:

MOR705GØ[średnica][tolerancja]MU2A-HU612

Wymiary typoszeregu z możliwością konfiguracji parametrów IT6

d_1	d_2	l_1	l_2	l_3	l_4	l_5	z
7,700 - 9,700	12	120	8	45	75	64	4
9,701 - 11,700	12	120	8	45	75	65	6
11,701 - 17,200	16	140	8	48	92	80	6
17,201 - 18,200	20	160	12	50	110	98	6
18,201 - 19,200	20	160	12	50	110	99	6
19,201 - 22,200	20	160	12	50	110	100	6
22,201 - 27,200	20	180	12	50	130	120	6
27,201 - 29,200	25	200	12	56	144	130	6
29,201 - 40,200	25	200	12	56	144	130	8

Przykład tolerancji \geq IT6:

MOR705Ø16.350H6MU2A-HU612

Średnica otworu $d_1 = 16,350$ H6

Przykład wariantu G:

MOR705GØ16.350-3MU2A-HU612

Średnica specjalna narzędzia $d_1 = 16,350 -3 \mu$ m

MonoReam Plus

Wersja monolityczna, do wykonywania otworu przelotowego
MRP510

Wersja:

Średnica rozwiertaka:

3,850 - 8,200 mm

Nakrój:

MG1M

Materiał skrawający:

CU178

Cermet bez powłoki

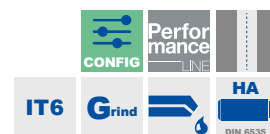
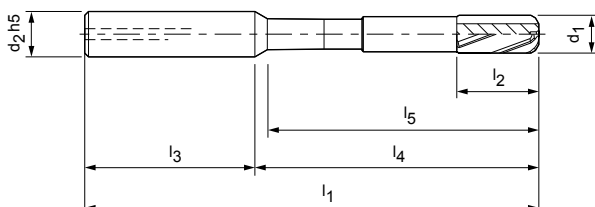

Możliwość konfiguracji parametrów

Tolerancja średnicy otworu \geq IT6:

- Możliwość wyboru średnicy w krokach co 0,001 mm
- Dostępne w tolerancji \geq IT6

Specyfikacja:

MRP510Ø[średnica][tolerancja]MG1M-CU178

Wariant G:

- Możliwość wyboru średnicy w krokach co 0,001 mm
- Dostępne od tolerancji \geq 3 μ m (wariant G – patrz strona 355)

Specyfikacja wariantu G:

MRP510GØ[średnica][tolerancja]MG1M-CU178

Wymiary typoszeregu z możliwością konfiguracji parametrów IT6

d_1	d_2	l_1	l_2	l_3	l_4	l_5	z
3,850 - 4,900	10	80	14	40	40	33	4
4,901 - 6,200	12	85	14	45	40	33	4
6,201 - 6,700	12	105	14	45	60	52	6
6,701 - 8,200	12	110	18	45	65	57	6

Przykład tolerancji \geq IT6:

MRP510Ø5.350H6MG1M-CU178

 Średnica otworu $d_1 = 5,350$ mm H6

Przykład wariantu G:

MRP510GØ5.350-3MG1M-CU178

 Średnica specjalna narzędzia $d_1 = 5,350$ -3 μ m

Wymiary podano w mm.

 * do powierzchni $R_a < 2$ μ m

Zalecane parametry skrawania – patrz koniec rozdziału.

MonoReam Plus

Wersja monolityczna, do wykonywania otworu przelotowego
MRP505

Wersja:

Średnica rozwiertaka:

3,850 - 8,200 mm

Nakrój:

MV3C

Materiał skrawający:

CU178
Cermet bez powłoki

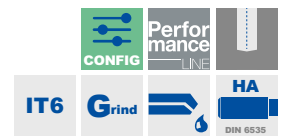
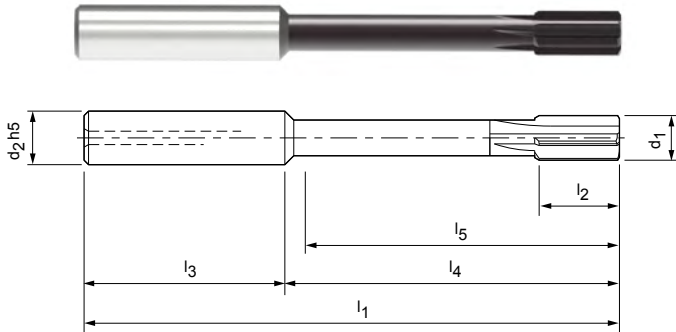

Możliwość konfiguracji parametrów



Tolerancja średnicy otworu \geq IT6:

- Możliwość wyboru średnicy w krokach co 0,001 mm
- Dostępne w tolerancji \geq IT6

Specyfikacja:

MRP505Ø[średnica][tolerancja]MV3C-CU178

Wariant G:

- Możliwość wyboru średnicy w krokach co 0,001 mm
- Dostępne od tolerancji \geq 3 μ m (wariant G – patrz strona 355)

Specyfikacja wariantu G:

MRP505GØ[średnica][tolerancja]MV3C-CU178

Wymiary typoszerogu z możliwością konfiguracji parametrów IT6

d_1	d_2	l_1	l_2	l_3	l_4	l_5	z
3,850 - 4,900	10	80	12	40	40	33	4
4,901 - 6,200	12	85	12	45	40	33	4
6,201 - 6,700	12	105	12	45	60	53	6
6,701 - 8,200	12	110	16	45	65	58	6

Przykład tolerancji \geq IT6:

MRP505Ø5.350H6MV3C-CU178

Średnica otworu $d_1 = 5,350$ mm H6

Przykład wariantu G:

MRP505Ø5.350-3MV3C-CU178

Średnica specjalna narzędzia $d_1 = 5,350 -3 \mu$ m

Wymiary podano w mm.

* do powierzchni $R_a < 2 \mu$ m

Zalecane parametry skrawania – patrz koniec rozdziału.

Zalecane parametry skrawania dla MonoReam MOR | MonoReam Plus MRP

Posuw i prędkość skrawania

MRP505 | MRP510

Materiał skrawający: CU178 | Nakrój: MV3C | MG1M

MZG*	Materiał obrabiany	Wytrzymałość/ twardość [N/mm ²] [HRC]	Prędkość skrawania v _c (m/min)				
			Chłodzenie wewnętrzne	Chłodzenie zewnętrzne	Mgielka		
P	P1	P1.1	Stale konstrukcyjne, użytkowe i uszlachetnione, stale niestopowe	< 700	150	75	125
		P1.2	Stale konstrukcyjne, użytkowe i uszlachetnione, stale niestopowe	< 1200	150	75	125
	P2	P2.1	Stale azotowane, użytkowe i uszlachetnione, stale stopowe	< 900	130	65	110
		P2.2	Stale azotowane, użytkowe i uszlachetnione, stale stopowe	< 1400	130	65	110
	P3	P3.1	Stale narzędziowe, łożyskowe, sprężynowe i stale szybkoobrotowe**	< 800	130	65	110
		P3.2	Stale narzędziowe, łożyskowe, sprężynowe i stale szybkoobrotowe**	< 1000	120	60	100
	P3.3	Stale narzędziowe, łożyskowe, sprężynowe i stale szybkoobrotowe**	< 1500				

MOR705 | MOR710

Materiał skrawający: CU130 | Nakrój: MU2A | MY1G

MZG*	Materiał obrabiany	Wytrzymałość/ twardość [N/mm ²] [HRC]	Prędkość skrawania v _c (m/min)				
			Chłodzenie wewnętrzne	Chłodzenie zewnętrzne	Mgielka		
P	P1	P1.1	Stale konstrukcyjne, użytkowe i uszlachetnione, stale niestopowe	< 700	150	75	125
		P1.2	Stale konstrukcyjne, użytkowe i uszlachetnione, stale niestopowe	< 1200	150	75	125
	P2	P2.1	Stale azotowane, użytkowe i uszlachetnione, stale stopowe	< 900	130	65	110
		P2.2	Stale azotowane, użytkowe i uszlachetnione, stale stopowe	< 1400	130	65	110
	P3	P3.1	Stale narzędziowe, łożyskowe, sprężynowe i stale szybkoobrotowe**	< 800	130	65	110
		P3.2	Stale narzędziowe, łożyskowe, sprężynowe i stale szybkoobrotowe**	< 1000	120	60	100
	P3.3	Stale narzędziowe, łożyskowe, sprężynowe i stale szybkoobrotowe**	< 1500				
K	K1	K1.1	Żeliwo z grafitem płatkowym (żeliwo szare), GJL	< 300	120	100	100
		K2.1	Żeliwo sferoidalne, GJS	< 500	120	85	105
		K2.2	Żeliwo sferoidalne, GJS	≤ 800			
		K2.3	Żeliwo sferoidalne, GJS	> 800			

MOR705 | MOR710

Materiał skrawający: HP421 | Nakrój: MU2A | MY1G

MZG*	Materiał obrabiany	Wytrzymałość/ twardość [N/mm ²] [HRC]	Prędkość skrawania v _c (m/min)				
			Chłodzenie wewnętrzne	Chłodzenie zewnętrzne	Mgielka		
P	P3	P3.1	Stale narzędziowe, łożyskowe, sprężynowe i stale szybkoobrotowe**	< 800			
		P3.2	Stale narzędziowe, łożyskowe, sprężynowe i stale szybkoobrotowe**	< 1000			
		P3.3	Stale narzędziowe, łożyskowe, sprężynowe i stale szybkoobrotowe**	< 1500	100	50	75
	P4	P4.1	Stale nierdzewne, ferrytyczne i martenzytyczne		40	20	30
	P5	P5.1	Staliwo		110	60	80
	P6	P6.1	Staliwo nierdzewne, ferrytyczne i martenzytyczne		40	20	30
K	K1	K1.1	Żeliwo z grafitem płatkowym (żeliwo szare), GJL	< 300	120	100	100
		K2.1	Żeliwo sferoidalne, GJS	< 500	110	80	95
		K2.2	Żeliwo sferoidalne, GJS	≤ 800	90	65	75
	K3	K2.3	Żeliwo sferoidalne, GJS	> 800	90	55	70
		K3.1	Żeliwo wermikularne, GJV, (żeliwo ciągliwe), GJL	< 500	90	55	70
		K3.2	Żeliwo wermikularne, GJV, (żeliwo ciągliwe), GJL	> 500	90	55	70

* Grupa materiałowa wg MAPAL

** Jeśli składniki stopu Cr, Mo, Ni, V, W wynoszą łącznie > 8%, należy wybrać następną w kolejności grupę materiałową MAPAL.

Posuw f_z (mm/z) dla średnicy narzędzia			
	z 4	z 4	z 6
	< 5,000	5,000 - 6,200	> 6,200 - 8,200
	0,025	0,040	0,060
	0,025	0,040	0,060
	0,025	0,040	0,060
	0,025	0,040	0,060
	0,025	0,040	0,060
	0,025	0,040	0,060

Posuw f_z (mm/z) dla średnicy narzędzia				
	z 4	z 6	z 6	z 8
	8,000 - 9,700	> 9,700 - 16,000	> 16,000 - 29,200	> 29,200 - 40,200
	0,100	0,150	0,150	0,150
	0,100	0,150	0,150	0,150
	0,100	0,150	0,150	0,150
	0,080	0,120	0,120	0,120
	0,100	0,150	0,150	0,150
	0,100	0,150	0,150	0,150
	0,150	0,200	0,200	0,250
	0,150	0,180	0,180	0,180

Posuw f_z (mm/z) dla średnicy narzędzia				
	z 4	z 6	z 6	z 8
	8,000 - 9,700	> 9,700 - 16,000	> 16,000 - 29,200	> 29,200 - 40,200
	0,100	0,150	0,150	0,150
	0,080	0,100	0,120	0,120
	0,150	0,150	0,150	0,150
	0,080	0,100	0,120	0,120
	0,150	0,200	0,200	0,250
	0,150	0,180	0,180	0,180
	0,150	0,180	0,180	0,180
	0,120	0,150	0,150	0,150
	0,150	0,180	0,180	0,180
	0,150	0,150	0,150	0,150

Podane parametry skrawania to wartości orientacyjne.

Optymalne wartości dla danego przypadku obróbki należy ustalić w ramach próby lub podczas obróbki.

Zalecane parametry skrawania dla MonoReam MOR

Posuw i prędkość skrawania

MOR700

Materiał skrawający: HU612 | Nakrój: MY1G

MZG*	Materiał obrabiany	Wytrzymałość/ twardość [N/mm ²] [HRC]	Prędkość skrawania v _c (m/min)		
			Chłodzenie wewnętrzne	Chłodzenie zewnętrzne	Mgielka
N1	N1.1 Aluminium, niestopowe i stopowe < 3 % Si		50	25	40
	N1.2 Aluminium, stopowe ≤ 7 % Si		50	25	40
	N1.3 Aluminium, stopowe > 7-12 % Si		30	15	25
	N1.4 Aluminium, stopowe > 12 % Si		30	15	25
N2	N2.1 Miedź, niestopowa i niskostopowa	< 300	50	25	
	N2.2 Miedź, stopowa	> 300	50	25	
	N2.3 Mosiądz, brąz, spiż	< 1200	50	25	40
N4	N4.1 Tworzywo sztuczne, materiały termoplastyczne		40	20	
	N4.2 Tworzywo sztuczne, duroplast		40	20	
	N4.3 Tworzywo sztuczne, pianki		40	20	

MOR705

Materiał skrawający: HU612 | Nakrój: MU2A

MZG*	Materiał obrabiany	Wytrzymałość/ twardość [N/mm ²] [HRC]	Prędkość skrawania v _c (m/min)		
			Chłodzenie wewnętrzne	Chłodzenie zewnętrzne	Mgielka
N1	N1.1 Aluminium, niestopowe i stopowe < 3 % Si		50	25	40
	N1.2 Aluminium, stopowe ≤ 7 % Si		50	25	40
	N1.3 Aluminium, stopowe > 7-12 % Si		30	15	25
	N1.4 Aluminium, stopowe > 12 % Si		30	15	25
N2	N2.1 Miedź, niestopowa i niskostopowa	< 300	50	25	
	N2.2 Miedź, stopowa	> 300	50	25	
	N2.3 Mosiądz, brąz, spiż	< 1200	50	25	40

	Posuw f_z (mm/z) dla średnicy narzędzia			
	z 4	z 6	z 6	z 8
	8,000 - 9,700	> 9,700 - 16,000	> 16,000 - 29,200	> 29,200 - 40,200
	0,050	0,080	0,100	0,120
	0,050	0,080	0,100	0,120
	0,050	0,080	0,100	0,120
	0,050	0,080	0,100	0,120
	0,050	0,080	0,100	0,120
	0,050	0,080	0,100	0,120
	0,050	0,080	0,100	0,120
	0,050	0,080	0,080	0,080
	0,050	0,080	0,080	0,080
	0,050	0,080	0,080	0,080

	Posuw f_z (mm/z) dla średnicy narzędzia			
	z 4	z 6	z 6	z 8
	8,000 - 9,700	> 9,700 - 16,000	> 16,000 - 29,200	> 29,200 - 40,200
	0,050	0,080	0,100	0,120
	0,050	0,080	0,100	0,120
	0,050	0,080	0,100	0,120
	0,050	0,080	0,100	0,120
	0,050	0,080	0,100	0,120
	0,050	0,080	0,100	0,120
	0,050	0,080	0,100	0,120

Podane parametry skrawania to wartości orientacyjne.

Optymalne wartości dla danego przypadku obróbki należy ustalić w ramach próby lub podczas obróbki.

PRZEGLĄD PRODUKTÓW

Rozwiertak z wymienną głowicą HPR

Gama rozwiertaków z wymienną głowicą HPR obejmuje serie do otworów przelotowych i nieprzelotowych od średnicy 7,00 mm. Rozwiertaki z wymienną głowicą są dostępne w wersji stałej (seria XX) lub w wersji z precyzyjną regulacją (seria XX) i mogą być wyposażone w różne materiały skrawające, takie jak węgiel lub cermet. Rozwiertaki mogą być skonfigurowane w zakresie średnic od 7,00 do 65,00 mm w krokach co μm i w zakresie tolerancji $\geq \text{IT5}$. Szeroki zakres wymiarów H7 jest dostępny jako seria preferowana.

Dzięki systemowi Head Fitting System (HFS) przynależne uchwyty charakteryzują się dokładną współosiowością i dokładnością wymiany poniżej $3 \mu\text{m}$ oraz bezpieczną, prostą obsługą, zwłaszcza podczas montażu i demontażu głowicy narzędziowej. HFS gwarantuje wysoką precyzję i przenoszenie mocy. Ze względu na prostą konstrukcję z bezpośrednim doprowadzeniem chłodziwa do krawędzi skrawającej, system jest warunkowo przystosowany do smarowania minimalną ilością (MMS).

HPR wersja monolityczna



HPR typoszereg 100 | 130 | 131 | 110 | 150 | 180

Wersja stała z ostrzami lutowanymi.

Zakres \varnothing : 7,000 – 65,000 mm*

Perfor
mance
LINE

CONFIG IT G_{rind}

P M K N S



HPR wersja z precyzyjną regulacją



HPR typoszereg 200 | 230 | 231 | 210 | 250 | 280

Możliwość regulacji z dokładnością do μm za pomocą systemu regulacji.

Zakres \varnothing : 7,000 – 65,000 mm*

Expert
LINE

CONFIG IT Grind

P M K N S

Krok 1:
Rodzaj otworu



Krok 2:
Grupa materiałowa



Krok 3:
Wersja



Krok 4:
Klasa produktu



Krok 5:
Wstępnie skonfigurowane
średnice lub konfiguracja



	Wersja			Wstępnie skonfigurowane średnice				Konfiguracja
	d1	Materiał skrawający	Nacięcie	Perforance LINE	Typoszereg narzędzi stałych	Expert LINE	Typoszereg narzędzi z precyzyjną regulacją	
				Typoszereg	Strona	Typoszereg	Strona	
	7,000 - 18,590	CU134	ME1G	HPR131	379	HPR231	418	HPR131 HPR231
	15,600 - 65,000	CU134	ME1G	HPR110	390	HPR210	426	
	7,000 - 18,590	HP421	ME1G	HPR131	380	HPR231	419	
	15,600 - 65,000	HP421	ME1G	HPR110	392	HPR210	427	
	7,000 - 18,590	HP421	MF1G	HPR131	381	HPR231	420	
	15,600 - 65,000	HP421	MF1G	HPR110	394	HPR210	428	
	7,000 - 18,590	CP134	MC1G	HPR130	374	HPR230	414	
	15,600 - 65,000	CP134	MC1G	HPR100	383	HPR200	422	
	7,000 - 18,590	HC419	MC1G	HPR130	375			
	15,600 - 65,000	HC419	MC1G	HPR100	384			
	7,000 - 18,590	HP421	MC1G	HPR130	376	HPR230	415	
	15,600 - 65,000	HP421	MC1G	HPR100	386	HPR200	423	
	7,000 - 18,590	HP423	MC1G	HPR130	377	HPR230	416	
	15,600 - 65,000	HP423	MC1G	HPR100	388	HPR200	424	
	7,000 - 18,590	PU620	MA0A	HPR130	378	HPR230	417	
	15,600 - 65,000	PU620	MA0A	HPR100	389	HPR200	425	
	7,000 - 18,590	HP625	MF1G	HPR131	382	HPR231	421	
	15,600 - 65,000	HP625	MF1G	HPR110	393	HPR210	431	
	7,000 - 21,290	CU134	ML2G	HPR180	396	HPR280	430	HPR180 HPR280
	16,600 - 65,000	CU134	ML2G	HPR150	405	HPR250	438	
	7,000 - 21,290	HP421	ML2G	HPR180	397	HPR280	431	
	16,600 - 65,000	HP421	ML2G	HPR150	406	HPR250	439	
	7,000 - 21,290	HP421	MO2G	HPR180	398	HPR280	432	
	16,600 - 65,000	HP421	MO2G	HPR150	407	HPR250	440	
	7,000 - 21,290	CP134	MC1G	HPR180	399	HPR280	433	
	16,600 - 65,000	CP134	MC1G	HPR150	408	HPR250	441	
	7,000 - 21,290	HC419	MC1G	HPR180	400			
	16,600 - 65,000	HC419	MC1G	HPR150	403			
	7,000 - 21,290	HP421	MC1G	HPR180	401	HPR280	434	
	16,600 - 65,000	HP421	MC1G	HPR150	410	HPR250	442	
	7,000 - 21,290	HP423	MC1G	HPR180	402	HPR280	435	
	16,600 - 65,000	HP423	MC1G	HPR150	411	HPR250	443	
	7,000 - 21,290	PU620	MA0A	HPR180	403	HPR280	436	
	16,600 - 65,000	PU620	MA0A	HPR150	412	HPR250	444	
	7,000 - 21,290	HP625	MO2G	HPR180	404	HPR280	437	
	16,600 - 65,000	HP625	MO2G	HPR150	413	HPR250	445	

Konfiguracja typoszeregu na następnej stronie.

Zestawienie modeli HPR | Konfiguracja (2/2)

HPR131 | HPR231

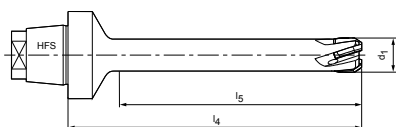

HPR130 | HPR230

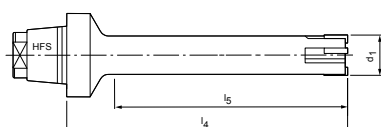

HPR180 | HPR280

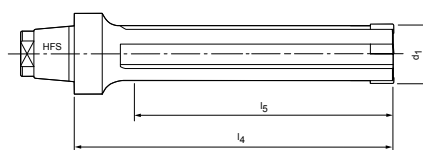

Wymiary narzędzia

	$\varnothing d_1$	l_4	l_5	Wielkość HFS	z
HPR130 131	7,000 - 9,590	60	45	12	4
HPR230 231	9,600 - 18,590	60	45	12	6
HPR180	7,000 - 14,590	60	40	12	4
HPR280	14,600 - 21,290	60	40	12	6
HPR100 HPR110	15,600 - 18,590	14	-	10	6
	18,600 - 21,290	14,5	-	12	6
	21,300 - 23,990	15,5	-	14	6
	24,000 - 29,990	16	-	16	6
	30,000 - 39,990	17	-	20	8
HPR150	40,000 - 50,700	19	-	24	8
	50,710 - 65,000	25	-	24	8
	16,600 - 21,290	14	-	10	6
	21,300 - 24,990	15,5	-	12	6
	25,000 - 28,990	15,5	-	14	6
HPR200 HPR210	29,000 - 36,990	17	-	16	6
	37,000 - 44,990	17	-	20	8
	45,000 - 50,700	19	-	24	8
	50,710 - 65,000	25	-	24	8
	HPR250	16,600 - 21,290	25	-	24
18,600 - 21,290		25	-	10	6
21,300 - 24,990		27	-	12	6
25,000 - 28,590		35	-	14	6
29,000 - 32,290		35	-	16	6
HPR200 HPR210	32,300 - 36,990	41	-	16	6
	37,000 - 41,190	41	-	20	8
	41,200 - 44,900	47	-	20	8
	45,000 - 65,000	47	-	24	8
	HPR250	16,600 - 21,290	25	-	10
21,300 - 24,990		27	-	12	6
25,000 - 28,590		35	-	14	6
29,000 - 32,290		35	-	16	6
32,300 - 36,990		41	-	16	6
HPR250	37,000 - 41,190	41	-	20	8
	41,200 - 44,900	47	-	20	8
	45,000 - 65,000	47	-	24	8

	$\varnothing d_1$	l_4	l_5	Wielkość HFS	z
HPR200 HPR210	18,600 - 20,390	25	-	12	6
	20,400 - 21,290	27	-	12	6
	21,300 - 23,990	27	-	14	6
	24,000 - 29,990	35	-	16	6
	30,000 - 39,990	41	-	20	8
HPR250	40,000 - 65,000	47	-	24	8
	16,600 - 21,290	25	-	10	6
	21,300 - 24,990	27	-	12	6
	25,000 - 28,590	35	-	14	6
	29,000 - 32,290	35	-	16	6
HPR250	32,300 - 36,990	41	-	16	6
	37,000 - 41,190	41	-	20	8
	41,200 - 44,900	47	-	20	8
	45,000 - 65,000	47	-	24	8

Przykład zamówienia:

Typoszereg

H P R

Rozwiertak z wymienną głowicą HPR

1 0 0

Wersje:

- 1 = rozwiertak stały
- 2 = rozwiertak z precyzyjną regulacją

G

Kąt pochylenia ostrza:

- 0 = prosty rowek wiórowy do \varnothing 65,000 mm
- 1 = rowek lewoskrętny do \varnothing 65,000 mm
- 3 = rowek lewoskrętny do \varnothing 18,590 mm
- 5 = otwór nieprzelotowy do \varnothing 65,000 mm
- 8 = otwór nieprzelotowy do \varnothing 21,290 mm

Średnica

Ø 2 0 . 0 0 0

Średnica otworu lub narzędzia

G = podana średnica narzędzia

Miejsce jest zajęte wyłącznie w przypadku wariantów C i G

Tolerancja

- 5

Tolerancja IT lub wymiary w μm (przykład: +30+10) lub dla wariantu G tolerancja produkcyjna średnicy szlifowania narzędzia, np. -3 μm

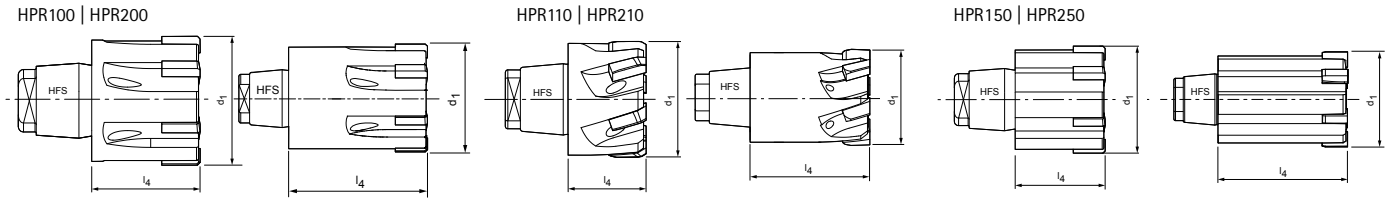

Dopuszczalne tolerancje obrabianego przedmiotu przy wyborze średnicy narzędzia:

Wersja stała:

IT6 (16 µm) powyżej ≥ Ø30,000 HPR

Jeżeli tolerancja średnicy obrabianego przedmiotu jest mniejsza niż wymieniona wyżej klasa tolerancji, można wybrać wersję z precyzyjną regulacją lub wersję stałą jako wariant G (specjalna średnica narzędzia).

Wersja z precyzyjną regulacją:

IT5 (11 µm) powyżej ≥ Ø30,000 HPR

Jeżeli tolerancja średnicy obrabianego przedmiotu jest mniejsza niż wymieniona wyżej klasa tolerancji, można wybrać wersję z precyzyjną regulacją jako wariant G (specjalna średnica narzędzia).

Wersja wariantu G

Wariant G wskazuje następną średnicę narzędzia rozwiertaka z naszymi tolerancjami produkcyjnymi.

Tolerancje dla wariantu G/wariantu stałego HPR1XX:

Materiał skrawający	Zakres średnicy	
	Ø 7 - < Ø 60	≥ Ø 60 - Ø 65
Bez powłoki		
HU612		
CU134	-0,003	-0,006
CU130		
PU620		
Z powłoką (grubość powłoki 1-2 µm)		
HP421		
CP134	-0,005	-0,008
HP625		
Z powłoką (grubość powłoki 2-4 µm)		
HP423		
HP463	-0,008	-0,010
CP132		
CP233		
Z powłoką (grubość powłoki 3-5 µm)		
HC412		
HC413	-0,007	-0,010
HC419		

Tolerancje dla wariantu G/wariantu z precyzyjną regulacją HPR2XX:

ogólny wymiar nastawczy +/-0,001

Nakrój [Lead]

Materiał skrawający [Cut]

M	C	1	G	-	H	P	4	2	1
<p>Typ nakroju i kąt natarcia:</p> <p>MC1G ME1G Wyjaśnienie geometrii nakroju – patrz strona 752.</p> <p>MA0A ML2G</p> <p>MO2G MF1G</p>					<p>Materiał skrawający:</p> <p>HP421 CU134</p> <p>HP422 HP625</p> <p>HP423 HC419</p> <p>CP134 PU620</p>				

Rozwiertak z wymienną głowicą HPR

Wersja monolityczna, prosty rowek wiórowy, do wykonywania otworu przelotowego
HPR130

Wersja:

Średnica rozwiertaka:

7,000 - 18,590 mm

Nakrój:

MC1G

Materiał skrawający:

CP134

Cermet z powłoką PVD

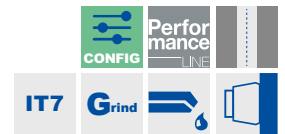
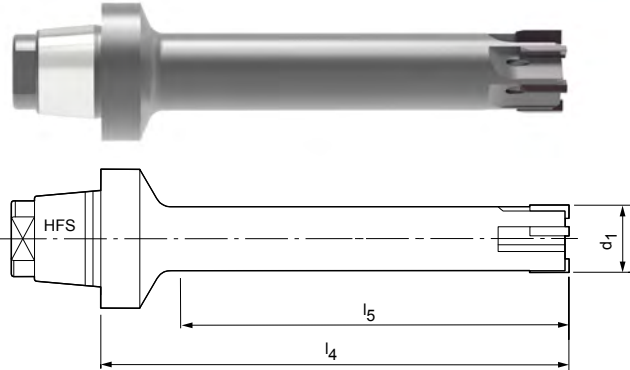

Możliwość konfiguracji parametrów

Tolerancja średnicy otworu IT7:

- Możliwość wyboru średnicy w krokach co 0,001 mm
- Dostępne w tolerancji IT7

Specyfikacja:

HPR130Ø[średnica][tolerancja]MC1G-CP134

Tolerancja średnicy otworu < IT7:

- Tolerancje mniejsze niż IT7 dostępne jako specjalna średnica narzędzia (wariant G – patrz strona 373)

Specyfikacja wariantu G:

HPR130GØ[średnica][tolerancja]MC1G-CP134

Wymiary typoszeregu z możliwością konfiguracji parametrów IT7

d_1	l_4	l_5	Wielkość HFS	z
7,000 - 9,590	60	45	12	4
9,600 - 18,590	60	45	12	6

Przykład tolerancji IT7:

HPR130Ø16.350H7MC1G-CP134

 Średnica otworu $d_1 = 16,350$ H7

Przykład wariantu G:

HPR130GØ16.350-5MC1G-CP134

 Średnica specjalna narzędzia $d_1 = 16,350$ -5 μ m

Wymiary podano w mm.

 * do powierzchni $R_a < 2 \mu$ m

Odpowiednie uchwyty wymiennej głowicy HFS od strony 460.

Zalecane parametry skrawania – patrz koniec rozdziału.

Rozwiertak z wymienną głowicą HPR

Wersja stała, prosty rowek wiórowy, do wykonywania otworu przelotowego
HPR130

Wersja:

Średnica rozwiertaka: 7,000 - 18,590 mm
Nakrój: MC1G
Materiał skrawający: HC419
Węglik spiekany z powłoką CVD

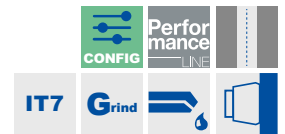
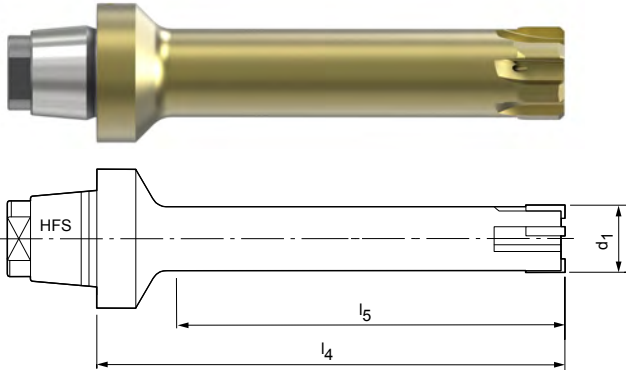

Możliwość konfiguracji parametrów



Tolerancja średnicy otworu IT7:

- Możliwość wyboru średnicy w krokach co 0,001 mm
- Dostępne w tolerancji IT7

Specyfikacja:

HPR130Ø[średnica][tolerancja]MC1G-HC419

Tolerancja średnicy otworu < IT7:

- Tolerancje mniejsze niż IT7 dostępne jako specjalna średnica narzędzia (wariant G – patrz strona 373)

Specyfikacja wariantu G:

HPR130GØ[średnica][tolerancja]MC1G-HC419

Wymiary typoszeregu z możliwością konfiguracji parametrów IT7

d ₁	l ₄	l ₅	Wielkość HFS	z
7,000 - 9,590	60	45	12	4
9,600 - 18,590	60	45	12	6

Przykład tolerancji IT7:

HPR130Ø16.350H7MC1G-HC419

Średnica otworu d₁ = 16,350 H7

Przykład wariantu G:

HPR130GØ16.350-7MC1G-HC419

Średnica specjalna narzędzia d₁ = 16,350 -7 μm

Wymiary podano w mm.

* do powierzchni R_a < 2 μm

Odpowiednie uchwyty wymiennej głowicy HFS od strony 460.

Zalecane parametry skrawania – patrz koniec rozdziału.

Rozwiertak z wymienną głowicą HPR

Wersja stała, prosty rowek wiórowy, do wykonywania otworu przelotowego
HPR130

Wersja:

Średnica rozwiertaka:

7,000 - 18,590 mm

Nakrój:

MC1G

Materiał skrawający:

Węglik spiekany z

powłoką PVD

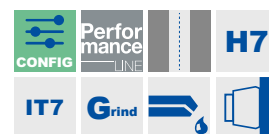
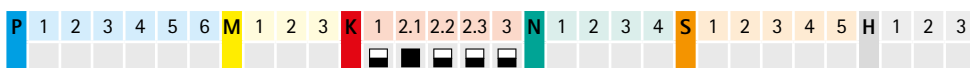
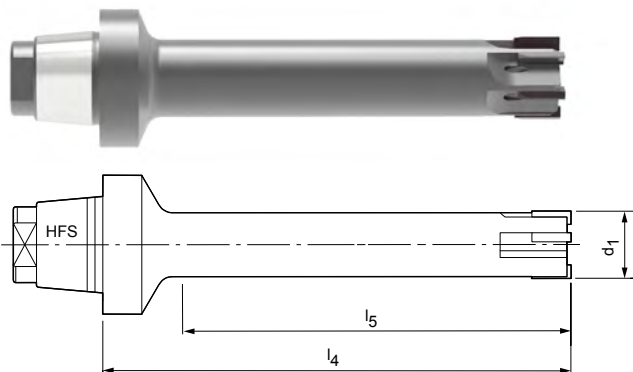

Magazynowa seria preferowana w tolerancji H7

d ₁ H7	Wielkość HFS	Wymiary			Specyfikacja	Nr materiałowy
		l ₄	l ₅	z		
10,000	12	60	45	6	HPR130Ø10H7MC1G-HP421	30058428
12,000	12	60	45	6	HPR130Ø12H7MC1G-HP421	30201261
14,000	12	60	45	6	HPR130Ø14H7MC1G-HP421	30710146
16,000	12	60	45	6	HPR130Ø16H7MC1G-HP421	30710148
18,000	12	60	45	6	HPR130Ø18H7MC1G-HP421	30156684

Możliwość konfiguracji parametrów



Tolerancja średnicy otworu IT7:

- Możliwość wyboru średnicy w krokach co 0,001 mm
- Dostępne w tolerancji IT7

Specyfikacja:

HPR130Ø[średnica][tolerancja]MC1G-HP421

Tolerancja średnicy otworu < IT7:

- Tolerancje mniejsze niż IT7 dostępne jako specjalna średnica narzędzia (wariant G – patrz strona 373)

Specyfikacja wariantu G:

HPR130GØ[średnica][tolerancja]MC1G-HP421

Wymiary typoszeregu z możliwością konfiguracji parametrów IT7

d ₁	l ₄	l ₅	Wielkość HFS	z
7,000 - 9,590	60	45	12	4
9,600 - 18,590	60	45	12	6

Przykład tolerancji IT7:

HPR130Ø16.350H7MC1G-HP421

Średnica otworu d₁ = 16,350 H7

Przykład wariantu G:

HPR130GØ16.350-5MC1G-HP421

Średnica specjalna narzędzia d₁ = 16,350 -5 μm

Wymiary podano w mm.

Odpowiednie uchwyty wymiennej głowicy HFS od strony 460.

Zalecane parametry skrawania – patrz koniec rozdziału.

Rozwiertak z wymienną głowicą HPR

Wersja stała, prosty rowek wiórowy, do wykonywania otworu przelotowego
HPR130

Wersja:
Średnica rozwiertaka: 7,000 - 18,590 mm
Nakrój: MC1G
Materiał skrawający: HP423
Węglik spiekany z powłoką PVD

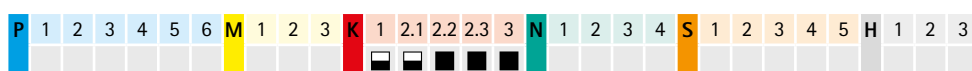
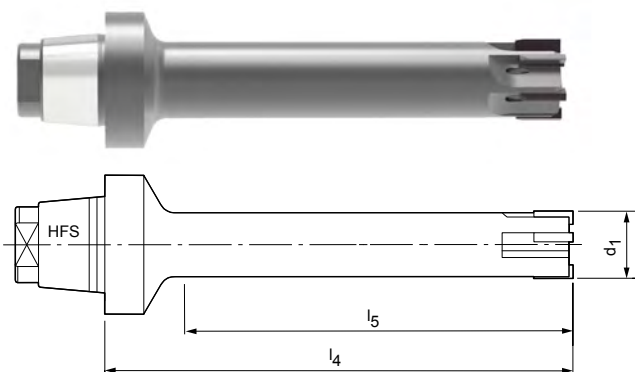

Możliwość konfiguracji parametrów



Tolerancja średnicy otworu IT7:
- Możliwość wyboru średnicy w krokach co 0,001 mm
- Dostępne w tolerancji IT7

Specyfikacja:
HPR130Ø[średnica][tolerancja]MC1G-HP423

Tolerancja średnicy otworu < IT7:
- Tolerancje mniejsze niż IT7 dostępne jako specjalna średnica narzędzia (wariant G – patrz strona 373)

Specyfikacja wariantu G:
HPR130GØ[średnica][tolerancja]MC1G-HP423

Wymiary typoszeregu z możliwością konfiguracji parametrów IT7

d ₁	l ₄	l ₅	Wielkość HFS	z
7,000 - 9,590	60	45	12	4
9,600 - 18,590	60	45	12	6

Przykład tolerancji IT7:
HPR130Ø16.350H7MC1G-HP423

Średnica otworu d₁ = 16,350 H7

Przykład wariantu G:
HPR130GØ16.350-8MC1G-HP423

Średnica specjalna narzędzia d₁ = 16,350 -8 μm

Wymiary podano w mm.
Odpowiednie uchwyty wymiennej głowicy HFS od strony 460.
Zalecane parametry skrawania – patrz koniec rozdziału.

Rozwiertak z wymienną głowicą HPR

Wersja stała, prosty rowek wiórowy, do wykonywania otworu przelotowego
HPR130

Wersja:

Średnica rozwiertaka: 7,000 - 18,590 mm

Nakrój: MA0A

Materiał skrawający: PU620

Z ostrzami PCD

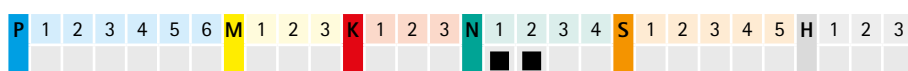
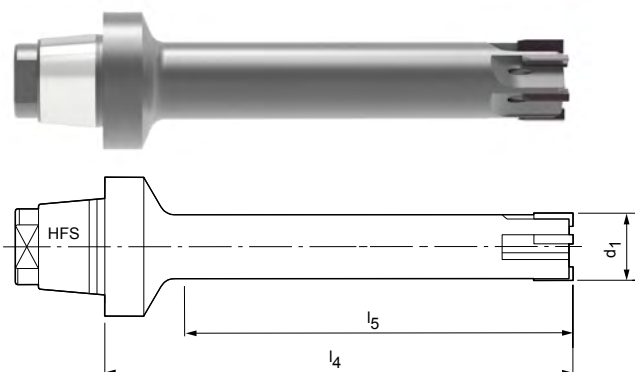

Możliwość konfiguracji parametrów

Tolerancja średnicy otworu IT7:

- Możliwość wyboru średnicy w krokach co 0,001 mm
- Dostępne w tolerancji IT7

Specyfikacja:

HPR130Ø[średnica][tolerancja]MA0A-PU620

Tolerancja średnicy otworu < IT7:

- Tolerancje mniejsze niż IT7 dostępne jako specjalna średnica narzędzia (wariant G – patrz strona 373)

Specyfikacja wariantu G:

HPR130GØ[średnica][tolerancja]MA0A-PU620

Wymiary typoszeregu z możliwością konfiguracji parametrów IT7

d_1	l_4	l_5	Wielkość HFS	z
7,000 - 9,590	60	45	12	4
9,600 - 18,590	60	45	12	6

Przykład tolerancji IT7:

HPR130Ø16.350H7MA0A-PU620

 Średnica otworu $d_1 = 16,350$ H7

Przykład wariantu G:

HPR130GØ16.350-3MA0A-PU620

 Średnica specjalna narzędzia $d_1 = 16,350$ -3 μ m

Wymiary podano w mm.

Odpowiednie uchwyty wymiennej głowicy HFS od strony 460.

Zalecane parametry skrawania – patrz koniec rozdziału.

Rozwiertak z wymienną głowicą HPR

Wersja stała, rowek lewoskrętny, do wykonywania otworu przelotowego
HPR131

Wersja:
Średnica rozwiertaka: 7,000 - 18,590 mm
Nakrój: ME1G
Materiał skrawający: CU134
Cermet bez powłoki

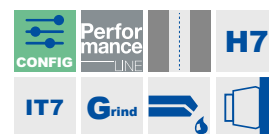
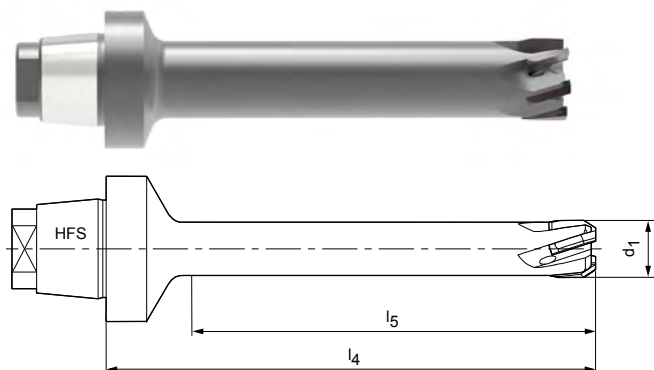

Magazynowa seria preferowana w tolerancji H7

d ₁ H7	Wielkość HFS	Wymiary			Specyfikacja	Nr materiałowy
		l ₄	l ₅	z		
10,000	12	60	45	6	HPR131Ø10H7ME1G-CU134	30043741
11,000	12	60	45	6	HPR131Ø11H7ME1G-CU134	30087260
12,000	12	60	45	6	HPR131Ø12H7ME1G-CU134	30041656
13,000	12	60	45	6	HPR131Ø13H7ME1G-CU134	30057835
14,000	12	60	45	6	HPR131Ø14H7ME1G-CU134	30082580
16,000	12	60	45	6	HPR131Ø16H7ME1G-CU134	30047996
18,000	12	60	45	6	HPR131Ø18H7ME1G-CU134	30048997

Możliwość konfiguracji parametrów

Tolerancja średnicy otworu IT7:

- Możliwość wyboru średnicy w krokach co 0,001 mm
- Dostępne w tolerancji IT7

Specyfikacja:
HPR131Ø[średnica][tolerancja]ME1G-CU134

Tolerancja średnicy otworu < IT7:

- Tolerancje mniejsze niż IT7 dostępne jako specjalna średnica narzędzia (wariant G – patrz strona 373)

Specyfikacja wariantu G:
HPR131GØ[średnica][tolerancja]ME1G-CU134

Wymiary typoszeregu z możliwością konfiguracji parametrów IT7

d ₁	l ₄	l ₅	Wielkość HFS	z
7,000 - 9,590	60	45	12	4
9,600 - 18,590	60	45	12	6

Przykład tolerancji IT7:
HPR131Ø16.350H7ME1G-CU134

Średnica otworu d₁ = 16,350 H7

Przykład wariantu G:
HPR131GØ16.350-3ME1G-CU134

Średnica specjalna narzędzia d₁ = 16,350 -3 μm

Wymiary podano w mm.
Odpowiednie uchwyty wymiennej głowicy HFS od strony 460.
Zalecane parametry skrawania – patrz koniec rozdziału.

Rozwiertak z wymienną głowicą HPR

Wersja stała, rowek lewoskrętny, do wykonywania otworu przelotowego
HPR131

Wersja:

Średnica rozwiertaka:

7,000 - 18,590 mm

Nakrój:

ME1G

Materiał skrawający:

Węgiel spiekany z
powłoką PVD

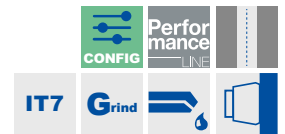
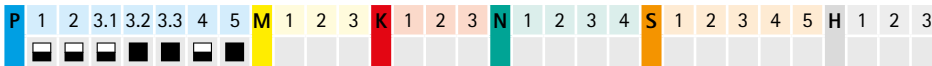
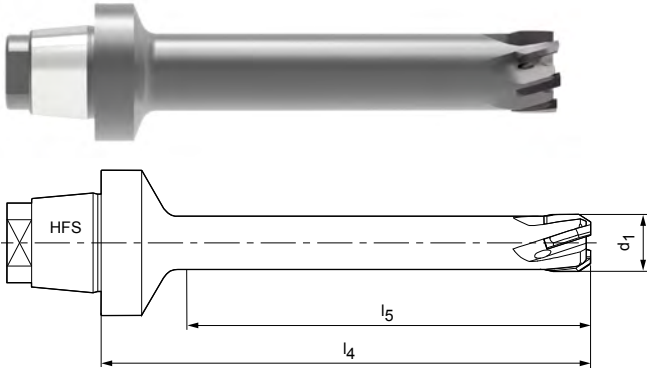

Możliwość konfiguracji parametrów



Tolerancja średnicy otworu IT7:

- Możliwość wyboru średnicy w krokach co 0,001 mm
- Dostępne w tolerancji IT7

Specyfikacja:

HPR131Ø[średnica][tolerancja]ME1G-HP421

Tolerancja średnicy otworu < IT7:

- Tolerancje mniejsze niż IT7 dostępne jako specjalna średnica narzędzia (wariant G – patrz strona 373)

Specyfikacja wariantu G:

HPR131GØ[średnica][tolerancja]ME1G-HP421

Wymiary typoszeregu z możliwością konfiguracji parametrów IT7

d_1	l_4	l_5	Wielkość HFS	z
7,000 - 9,590	60	45	12	4
9,600 - 18,590	60	45	12	6

Przykład tolerancji IT7:

HPR131Ø16.350H7ME1G-HP421

Średnica otworu $d_1 = 16,350 H7$

Przykład wariantu G:

HPR131GØ16.350-5ME1G-HP421

Średnica specjalna narzędzia $d_1 = 16,350 -5 \mu m$

Wymiary podano w mm.

Odpowiednie uchwyty wymiennej głowicy HFS od strony 460.

Zalecane parametry skrawania – patrz koniec rozdziału.

Rozwiertak z wymienną głowicą HPR

Wersja stała, rowek lewoskrętny, do wykonywania otworu przelotowego
HPR131

Wersja:
Średnica rozwiertaka: 7,000 - 18,590 mm
Nakrój: MF1G
Materiał skrawający: HP421
Węglik spiekany z powłoką PVD

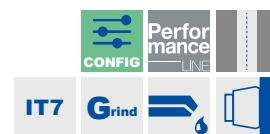
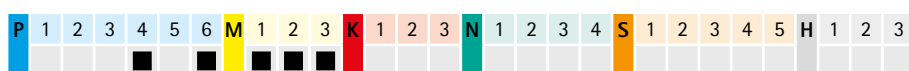
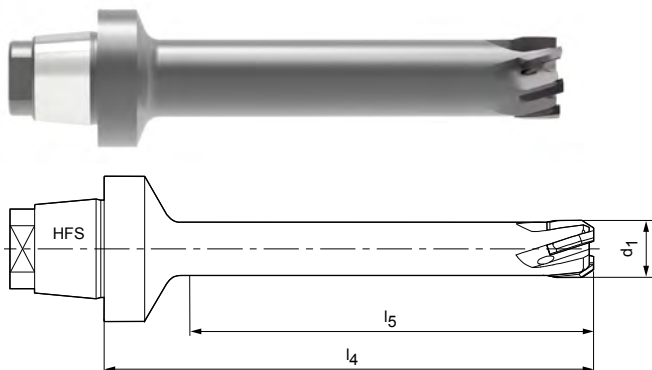

Uprzywilejowana seria w akcjach w H7

d ₁ H7	Rozmiar HFS	Wymiary konstrukcji			Specyfikacja	Nr materiałowy
		l ₄	l ₅	z		
10,000	12	60	45	6	HPR131Ø10.0H7MF1G-HP421	30710160
11,000	12	60	45	6	HPR131Ø11.00H7MF1G-HP421	30710161
12,000	12	60	45	6	HPR131Ø12.00H7MF1G-HP421	30710162
13,000	12	60	45	6	HPR131Ø13.00H7MF1G-HP421	30710163
14,000	12	60	45	6	HPR131Ø14.00H7MF1G-HP421	30710164
16,000	12	60	45	6	HPR131Ø16.00H7MF1G-HP421	30710166
18,000	12	60	45	6	HPR131Ø18.00H7MF1G-HP421	30710168

Możliwość konfiguracji parametrów



Tolerancja średnicy otworu IT7:

- Możliwość wyboru średnicy w krokach co 0,001 mm
- Dostępne w tolerancji IT7

Specyfikacja:

HPR131Ø[średnica][tolerancja]MF1G-HP421

Tolerancja średnicy otworu < IT7:

- Tolerancje mniejsze niż IT7 dostępne jako specjalna średnica narzędzia (wariant G – patrz strona 373)

Specyfikacja wariantu G:

HPR131GØ[średnica][tolerancja]MF1G-HP421

Wymiary typoszeregu z możliwością konfiguracji parametrów IT7

d ₁	l ₄	l ₅	Wielkość HFS	z
7,000 - 9,590	60	45	12	4
9,600 - 18,590	60	45	12	6

Przykład tolerancji IT7:

HPR131Ø16.350H7MF1G-HP421

Średnica otworu d₁ = 16,350 H7

Przykład wariantu G:

HPR131GØ16.350-5MF1G-HP421

Średnica specjalna narzędzia d₁ = 16,350 -5 μm

Wymiary podano w mm.

Odpowiednie uchwyty wymiennej głowicy HFS od strony 460.

Zalecane parametry skrawania – patrz koniec rozdziału.

Rozwiertak z wymienną głowicą HPR

Wersja stała, rowek lewoskrętny, do wykonywania otworu przelotowego
HPR131

Wersja:

Średnica rozwiertaka:

7,000 - 18,590 mm

Nakrój:

MF1G

Materiał skrawający:

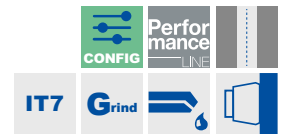
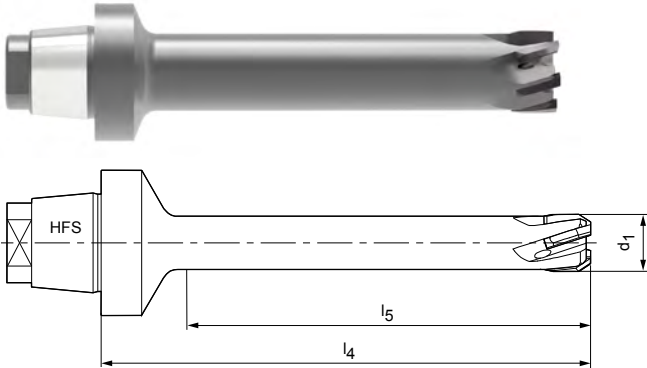
 Węgiel spiekany z
powłoką PVD

Możliwość konfiguracji parametrów

Tolerancja średnicy otworu IT7:

- Możliwość wyboru średnicy w krokach co 0,001 mm
- Dostępne w tolerancji IT7

Specyfikacja:

HPR131Ø[średnica][tolerancja]MF1G-HP625

Tolerancja średnicy otworu < IT7:

- Tolerancje mniejsze niż IT7 dostępne jako specjalna średnica narzędzia (wariant G – patrz strona 373)

Specyfikacja wariantu G:

HPR131GØ[średnica][tolerancja]MF1G-HP625

Wymiary typoszeregu z możliwością konfiguracji parametrów IT7

d_1	l_4	l_5	Wielkość HFS	z
7,000 - 9,590	60	45	12	4
9,600 - 18,590	60	45	12	6

Przykład tolerancji IT7:

HPR131Ø16.350H7MF1G-HP625

 Średnica otworu $d_1 = 16,350 \text{ H7}$
Przykład wariantu G:

HPR131GØ16.350-7MF1G-HP625

 Średnica specjalna narzędzia $d_1 = 16,350 -5 \mu\text{m}$

Wymiary podano w mm.

Odpowiednie uchwyty wymiennej głowicy HFS od strony 460.

Zalecane parametry skrawania – patrz koniec rozdziału.

Rozwiertak z wymienną głowicą HPR

Wersja stała, prosty rowek wiórowy, do wykonywania otworu przelotowego
HPR100

Wersja:

Średnica rozwiertaka:

15,600 – 65,000 mm

Nakrój:

MC1G

Materiał skrawający:

CP134

Cermet z powłoką PVD

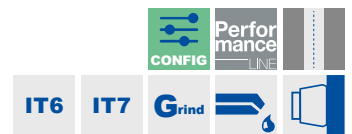
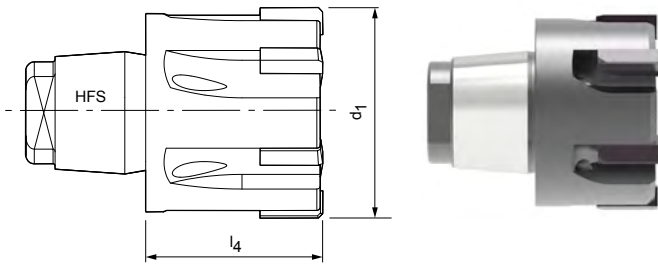

Możliwość konfiguracji parametrów



Tolerancja średnicy otworu IT6/IT7:

- Możliwość wyboru średnicy w krokach co 0,001 mm
- W zależności od zakresu średnicy, dostępne od tolerancji IT6/IT7
- > Ø30,000 IT6 | ≤ Ø30,000 IT7

Specyfikacja:

HPR100Ø[średnica][tolerancja]MC1G-CP134

Tolerancja średnicy otworu < IT6/IT7:

- Tolerancje mniejsze niż IT6/IT7 dostępne jako specjalna średnica narzędzia (wariant G – patrz strona 373)

Specyfikacja wariantu G:

HPR100GØ[średnica][tolerancja]MC1G-CP134

Wymiary typoszeregu z możliwością konfiguracji parametrów IT6/IT7

d1	l4	l5	Wielkość HFS	z	Tolerancja
15,600 - 18,590	14	-	10	6	IT7
18,600 - 21,290	14,5	-	12	6	IT7
21,300 - 23,990	15,5	-	14	6	IT7
24,000 - 29,990	16	-	16	6	IT7
30,000 - 39,990	17	-	20	8	IT6
40,000 - 50,700	19	-	24	8	IT6
50,710 - 65,000	25	-	24	8	IT6

Przykład tolerancji IT7:

HPR100Ø16.350H7MC1G-CP134

Średnica otworu d1 = 16,350 H7

Przykład wariantu G:

HPR100GØ16.350-5MC1G-CP134

Średnica specjalna narzędzia d1 = 16,350 -5 µm

Wymiary podano w mm.

* do powierzchni Ra < 2 µm

Odpowiednie uchwyty wymiennej głowicy HFS od strony 460.

Zalecane parametry skrawania – patrz koniec rozdziału.

Rozwiertak z wymienną głowicą HPR

Wersja stała, prosty rowek wiórowy, do wykonywania otworu przelotowego
HPR100

Wersja:

Średnica rozwiertaka:

15,600 – 65,000 mm

Nakrój:

MC1G

Materiał skrawający:

Węgiel spiekany z

powłoką CVD

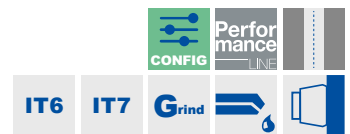
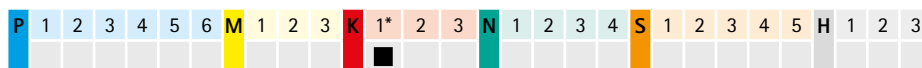
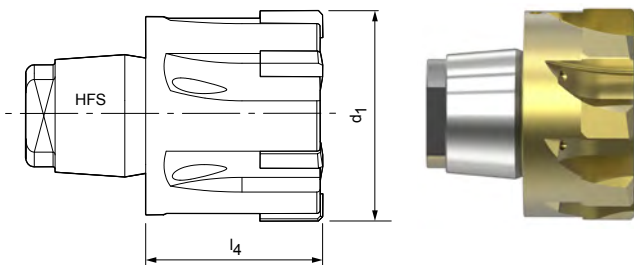

Możliwość konfiguracji parametrów



Tolerancja średnicy otworu IT6/IT7:

- Możliwość wyboru średnicy w krokach co 0,001 mm
- W zależności od zakresu średnicy, dostępne od tolerancji IT6/IT7
- > Ø30,000 IT6 | ≤ Ø30,000 IT7

Specyfikacja:

HPR100Ø[średnica][tolerancja]MC1G-HC419

Tolerancja średnicy otworu < IT6/IT7:

- Tolerancje mniejsze niż IT6/IT7 dostępne jako specjalna średnica narzędzia (wariant G – patrz strona 373)

Specyfikacja wariantu G:

HPR100GØ[średnica][tolerancja]MC1G-HC419

Wymiary typoszeregu z możliwością konfiguracji parametrów IT6/IT7

d1	l ₄	l ₅	Wielkość HFS	z	Tolerancja
15,600 – 18,590	14	–	10	6	IT7
18,600 – 21,290	14,5	–	12	6	IT7
21,300 – 23,990	15,5	–	14	6	IT7
24,000 – 29,990	16	–	16	6	IT7
30,000 – 39,990	17	–	20	8	IT6
40,000 – 50,700	19	–	24	8	IT6
50,710 – 65,000	25	–	24	8	IT6

Przykład tolerancji IT7:

HPR100Ø16.350H7MC1G-HC419

Średnica otworu d₁ = 16,350 H7

Przykład wariantu G:

HPR100GØ16.350-7MC1G-HC419

Średnica specjalna narzędzia d₁ = 16,350 -7 μm

Wymiary podano w mm.

* do powierzchni Ra > 2 μm

Odpowiednie uchwyty wymiennej głowicy HFS od strony 460.

Zalecane parametry skrawania – patrz koniec rozdziału.

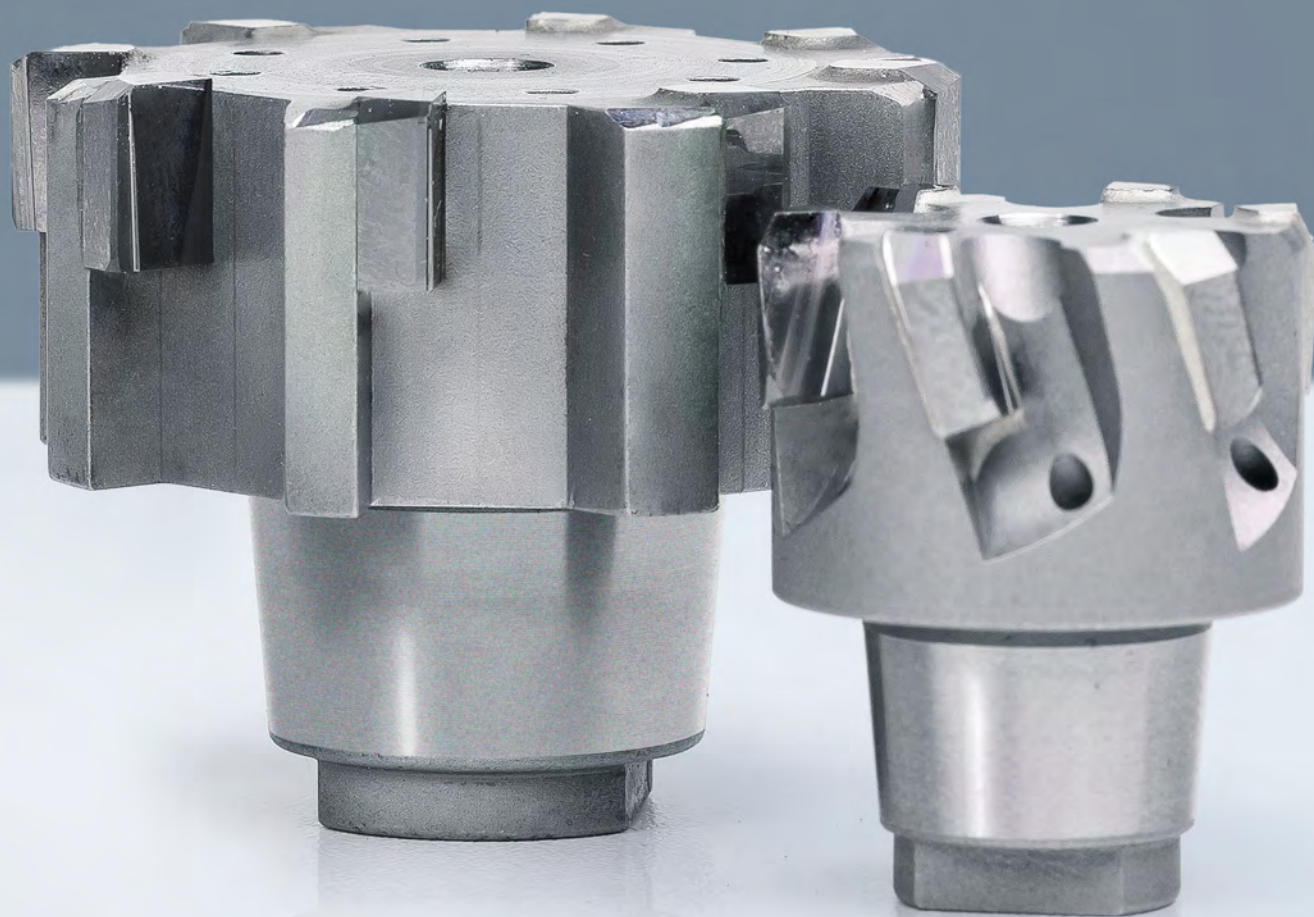

Rozwiertak z wymienną głowicą HPR

Wersja monolityczna, prosty rowek wiórowy, do wykonywania otworu przelotowego
HPR100

Wersja:

Średnica rozwiertaka:

15,600 – 65,000 mm

Nakrój:

HP421

Materiał skrawający:

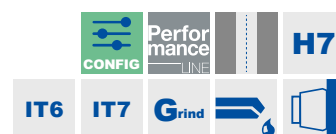
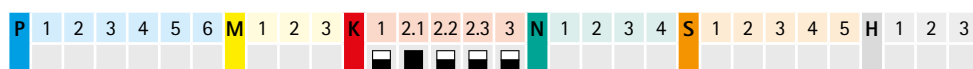
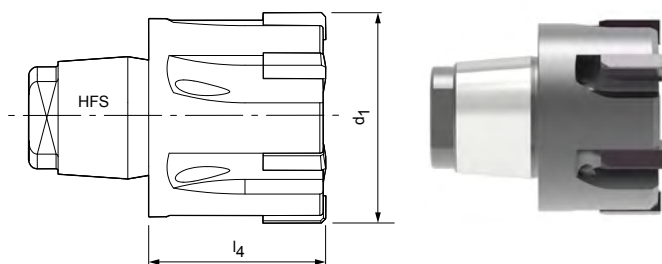
 Węgiel spiekany z
powłoką PVD

Magazynowa seria preferowana w tolerancji H7

d ₁ H7	Wielkość HFS	Wymiary		Specyfikacja	Nr materiałowy
		l ₄	z		
19,000	12	14,5	6	HPR100Ø19H7MC1G-HP421	30037777
20,000	12	14,5	6	HPR100Ø20H7MC1G-HP421	30191340
22,000	14	15,5	6	HPR100Ø22H7MC1G-HP421	30368857
24,000	16	16	6	HPR100Ø24H7MC1G-HP421	30181729
25,000	16	16	6	HPR100Ø25H7MC1G-HP421	30537929
26,000	16	16	6	HPR100Ø26H7MC1G-HP421	30076945
28,000	16	16	6	HPR100Ø28H7MC1G-HP421	30025212
30,000	20	17	8	HPR100Ø30H7MC1G-HP421	30031345
32,000	20	17	8	HPR100Ø32H7MC1G-HP421	30438453
35,000	20	17	8	HPR100Ø35H7MC1G-HP421	30537930
40,000	24	19	8	HPR100Ø40H7MC1G-HP421	30083953
45,000	24	19	8	HPR100Ø45H7MC1G-HP421	30537931
50,000	24	19	8	HPR100Ø50H7MC1G-HP421	30710245
55,000	24	25	8	HPR100Ø55H7MC1G-HP421	30419154
60,000	24	25	8	HPR100Ø60H7MC1G-HP421	30350208
65,000	24	25	8	HPR100Ø65H7MC1G-HP421	30272888

Wymiary podano w mm.

Odpowiednie uchwyty wymiennej głowicy HFS od strony 460.

Zalecane parametry skrawania – patrz koniec rozdziału.

HPR100 | Wersja stała, prosty rowek wiórowy

Możliwość konfiguracji parametrów

**Tolerancja średnicy otworu IT6/IT7:**

- Możliwość wyboru średnicy w krokach co 0,001 mm
- W zależności od zakresu średnicy, dostępne od tolerancji IT6/IT7
- > Ø30,000 IT6 | ≤ Ø30,000 IT7

Specyfikacja:

HPR100Ø[średnica][tolerancja]MC1G-HP421

Tolerancja średnicy otworu < IT6/IT7:

- Tolerancje mniejsze niż IT6/IT7 dostępne jako specjalna średnica narzędzia (wariant G – patrz strona 373)

Specyfikacja wariantu G:

HPR100GØ[średnica][tolerancja]MC1G-HP421

Wymiary typoszeregu z możliwością konfiguracji parametrów IT6/IT7

d1	l ₄	l ₅	Wielkość HFS	z	Tolerancja
15,600 - 18,590	14	-	10	6	IT7
18,600 - 21,290	14,5	-	12	6	IT7
21,300 - 23,990	15,5	-	14	6	IT7
24,000 - 29,990	16	-	16	6	IT7
30,000 - 39,990	17	-	20	8	IT6
40,000 - 50,700	19	-	24	8	IT6
50,710 - 65,000	25	-	24	8	IT6

Przykład tolerancji IT7:

HPR100Ø16.350H7MC1G-HP421

Średnica otworu d₁ = 16,350 H7**Przykład wariantu G:**

HPR100GØ16.350-5MC1G-HP421

Średnica specjalna narzędzia d₁ = 16,350 -5 μm

Rozwiertak z wymienną głowicą HPR

Wersja stała, prosty rowek wiórowy, do wykonywania otworu przelotowego
HPR100

Wersja:

Średnica rozwiertaka:

15,600 – 65,000 mm

Nakrój:

MC1G

Materiał skrawający:

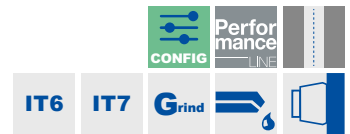
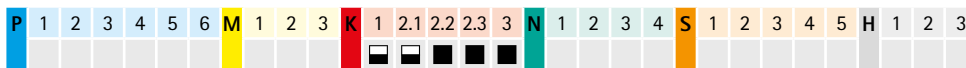
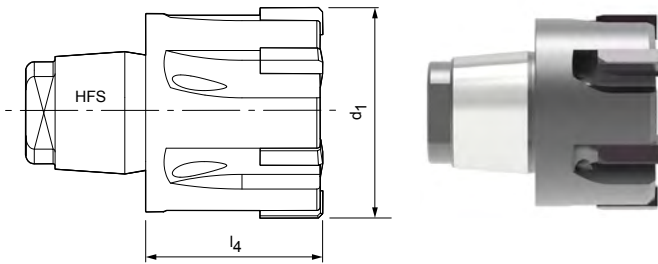
 Węgiel spiekany z
powłoką PVD

Możliwość konfiguracji parametrów

Tolerancja średnicy otworu IT6/IT7:

- Możliwość wyboru średnicy w krokach co 0,001 mm
- W zależności od zakresu średnicy, dostępne od tolerancji IT6/IT7
- > Ø30,000 IT6 | ≤ Ø30,000 IT7

Specyfikacja:

HPR100Ø[średnica][tolerancja]MC1G-HP423

Tolerancja średnicy otworu < IT6/IT7:

- Tolerancje mniejsze niż IT6/IT7 dostępne jako specjalna średnica narzędzia (wariant G – patrz strona 373)

Specyfikacja wariantu G:

HPR100GØ[średnica][tolerancja]MC1G-HP423

Wymiary typoszeregu z możliwością konfiguracji parametrów IT6/IT7

d1	l ₄	l ₅	Wielkość HFS	z	Tolerancja
15,600 – 18,590	14	–	10	6	IT7
18,600 – 21,290	14,5	–	12	6	IT7
21,300 – 23,990	15,5	–	14	6	IT7
24,000 – 29,990	16	–	16	6	IT7
30,000 – 39,990	17	–	20	8	IT6
40,000 – 50,700	19	–	24	8	IT6
50,710 – 65,000	25	–	24	8	IT6

Przykład tolerancji IT7:

HPR100Ø16.350H7MC1G-HP423

 Średnica otworu d₁ = 16,350 H7

Przykład wariantu G:

HPR100GØ16.350-8MC1G-HP423

 Średnica specjalna narzędzia d₁ = 16,350 -7 μm

Wymiary podano w mm.

Odpowiednie uchwyty wymiennej głowicy HFS od strony 460.

Zalecane parametry skrawania – patrz koniec rozdziału.

Rozwiertak z wymienną głowicą HPR

Wersja stała, prosty rowek wiórowy, do wykonywania otworu przelotowego
HPR100

Wersja:
Średnica rozwiertaka: 15,600 - 65,000 mm
Nakrój: MA0A
Materiał skrawający: PU620
Z ostrzami PCD

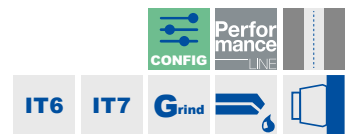
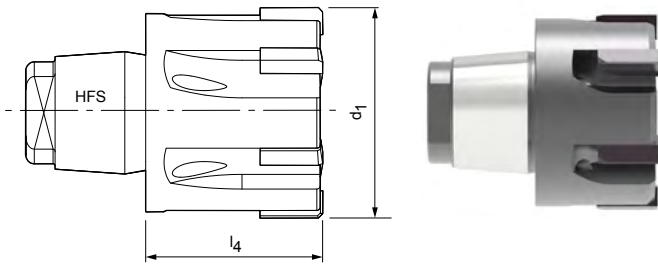

Możliwość konfiguracji parametrów



Tolerancja średnicy otworu IT6/IT7:

- Możliwość wyboru średnicy w krokach co 0,001 mm
- W zależności od zakresu średnicy, dostępne od tolerancji IT6/IT7
- > Ø30,000 IT6 | ≤ Ø30,000 IT7

Specyfikacja:

HPR100Ø[średnica][tolerancja]MA0A-PU620

Tolerancja średnicy otworu < IT6/IT7:

- Tolerancje mniejsze niż IT6/IT7 dostępne jako specjalna średnica narzędzia (wariant G – patrz strona 373)

Specyfikacja wariantu G:

HPR100GØ[średnica][tolerancja]MA0A-PU620

Wymiary typoszeregu z możliwością konfiguracji parametrów IT6/IT7

d1	l4	l5	Wielkość HFS	z	Tolerancja
15,600 - 18,590	14	-	10	6	IT7
18,600 - 21,290	14,5	-	12	6	IT7
21,300 - 23,990	15,5	-	14	6	IT7
24,000 - 29,990	16	-	16	6	IT7
30,000 - 39,990	17	-	20	8	IT6
40,000 - 50,700	19	-	24	8	IT6
50,710 - 65,000	25	-	24	8	IT6

Przykład tolerancji IT7:

HPR100Ø16.350H7MA0A-PU620

Średnica otworu d₁ = 16,350 H7

Przykład wariantu G:

HPR100GØ16.350-3MA0A-PU620

Średnica specjalna narzędzia d₁ = 16,350 -3 μm

Wymiary podano w mm.

Odpowiednie uchwyty wymiennej głowicy HFS od strony 460.

Zalecane parametry skrawania – patrz koniec rozdziału.

Rozwiertak z wymienną głowicą HPR

Wersja stała, rowek lewoskrętny, do wykonywania otworu przelotowego
HPR110

Wersja:

Średnica rozwiertaka:

15,600 – 65,000 mm

Nakrój:

ME1G

Materiał skrawający:

CU134

Cermet bez powłoki

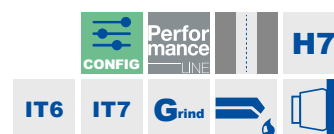
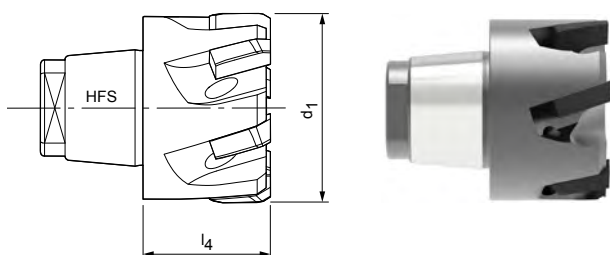

Magazynowa seria preferowana w tolerancji H7

d ₁ H7	Wielkość HFS	Wymiary		Specyfikacja	Nr materiałowy
		l ₄	z		
19,000	12	14,5	6	HPR110Ø19H7ME1G-CU134	30077358
20,000	12	14,5	6	HPR110Ø20H7ME1G-CU134	30040404
21,000	12	14,5	6	HPR110Ø21H7ME1G-CU134	30039919
22,000	14	15,5	6	HPR110Ø22H7ME1G-CU134	30081546
23,000	14	15,5	6	HPR110Ø23H7ME1G-CU134	30085368
24,000	16	16	6	HPR110Ø24H7ME1G-CU134	30080958
25,000	16	16	6	HPR110Ø25H7ME1G-CU134	30076110
26,000	16	16	6	HPR110Ø26H7ME1G-CU134	30045730
27,000	16	16	6	HPR110Ø27H7ME1G-CU134	30087257
28,000	16	16	6	HPR110Ø28H7ME1G-CU134	30046121
30,000	20	17	8	HPR110Ø30H7ME1G-CU134	30045095
31,000	20	17	8	HPR110Ø31H7ME1G-CU134	30192960
32,000	20	17	8	HPR110Ø32H7ME1G-CU134	30084530
33,000	20	17	8	HPR110Ø33H7ME1G-CU134	30162282
34,000	20	17	8	HPR110Ø34H7ME1G-CU134	30043743
35,000	20	17	8	HPR110Ø35H7ME1G-CU134	30084885
39,000	20	17	8	HPR110Ø39H7ME1G-CU134	30088042
40,000	24	19	8	HPR110Ø40H7ME1G-CU134	30045097
42,000	24	19	8	HPR110Ø42H7ME1G-CU134	30080437
44,000	24	19	8	HPR110Ø44H7ME1G-CU134	30097178
45,000	24	19	8	HPR110Ø45H7ME1G-CU134	30049313
50,000	24	19	8	HPR110Ø50H7ME1G-CU134	30219386
55,000	24	25	8	HPR110Ø55H7ME1G-CU134	30196567
60,000	24	25	8	HPR110Ø60H7ME1G-CU134	30242416
65,000	24	25	8	HPR110Ø65H7ME1G-CU134	30236537

Wymiary podano w mm.

Odpowiednie uchwyty wymiennej głowicy HFS od strony 460.

Zalecane parametry skrawania – patrz koniec rozdziału.

HPR110 | Wersja stała, rowek lewoskrętny

Możliwość konfiguracji parametrów

**Tolerancja średnicy otworu IT6/IT7:**

- Możliwość wyboru średnicy w krokach co 0,001 mm
- W zależności od zakresu średnicy, dostępne od tolerancji IT6/IT7
- > Ø30,000 IT6 | ≤ Ø30,000 IT7

Specyfikacja:

HPR110Ø[średnica][tolerancja]ME1G-CU134

Tolerancja średnicy otworu < IT6/IT7:

- Tolerancje mniejsze niż IT6/IT7 dostępne jako specjalna średnica narzędzia (wariant G – patrz strona 373)

Specyfikacja wariantu G:

HPR110GØ[średnica][tolerancja]ME1G-CU134

Wymiary typoszeregu z możliwością konfiguracji parametrów IT6/IT7

d1	l ₄	l ₅	Wielkość HFS	z	Tolerancja
15,600 - 18,590	14	-	10	6	IT7
18,600 - 21,290	14,5	-	12	6	IT7
21,300 - 23,990	15,5	-	14	6	IT7
24,000 - 29,990	16	-	16	6	IT7
30,000 - 39,990	17	-	20	8	IT6
40,000 - 50,700	19	-	24	8	IT6
50,710 - 65,000	25	-	24	8	IT6

Przykład tolerancji IT7:

HPR110Ø16.350H7ME1G-CU134

Średnica otworu d₁ = 16,350 H7**Przykład wariantu G:**

HPR110GØ16.350-3ME1G-CU134

Średnica specjalna narzędzia d₁ = 16,350 -3 μm

Rozwiertak z wymienną głowicą HPR

Wersja monolityczna, rowek lewoskrętny, do wykonywania otworu przelotowego
HPR110

Wersja:

Średnica rozwiertaka:

15,600 – 65,000 mm

Nakrój:

ME1G

Materiał skrawający:

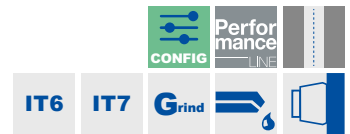
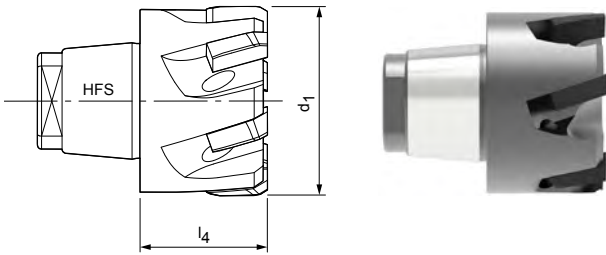
 Węgiel spiekany z
powłoką PVD

Możliwość konfiguracji parametrów

Tolerancja średnicy otworu IT6/IT7:

- Możliwość wyboru średnicy w krokach co 0,001 mm
- W zależności od zakresu średnicy, dostępne od tolerancji IT6/IT7
- > Ø30,000 IT6 | ≤ Ø30,000 IT7

Specyfikacja:

HPR110Ø[średnica][tolerancja]ME1G-HP421

Tolerancja średnicy otworu < IT6/IT7:

- Tolerancje mniejsze niż IT6/IT7 dostępne jako specjalna średnica narzędzia (wariant G – patrz strona 373)

Specyfikacja wariantu G:

HPR110GØ[średnica][tolerancja]ME1G-HP421

Wymiary typoszeru z możliwością konfiguracji parametrów IT6/IT7

d1	l ₄	l ₅	Wielkość HFS	z	Tolerancja
15,600 – 18,590	14	–	10	6	IT7
18,600 – 21,290	14,5	–	12	6	IT7
21,300 – 23,990	15,5	–	14	6	IT7
24,000 – 29,990	16	–	16	6	IT7
30,000 – 39,990	17	–	20	8	IT6
40,000 – 50,700	19	–	24	8	IT6
50,710 – 65,000	25	–	24	8	IT6

Przykład tolerancji IT7:

HPR110Ø16.350H7ME1G-HP421

 Średnica otworu d₁ = 16,350 H7

Przykład wariantu G:

HPR110GØ16.350-5ME1G-HP421

 Średnica specjalna narzędzia d₁ = 16,350 -5 μm

Wymiary podano w mm.

Odpowiednie uchwyty wymiennej głowicy HFS od strony 460.

Zalecane parametry skrawania – patrz koniec rozdziału.

Rozwiertak z wymienną głowicą HPR

Wersja stała, rowek lewoskrętny, do wykonywania otworu przelotowego
HPR110

Wersja:

Średnica rozwiertaka: 15,600 - 65,000 mm
Nakrój: MF1G
Materiał skrawający: HP625
Węglik spiekany z powłoką PVD

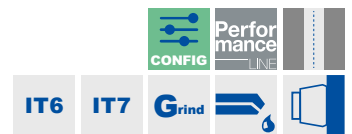
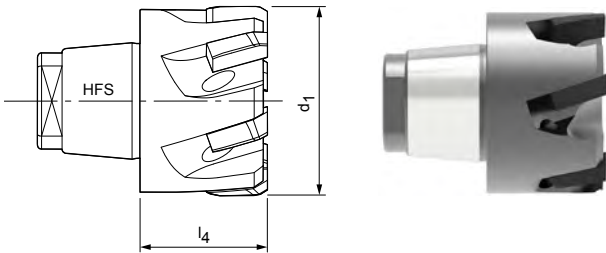

Możliwość konfiguracji parametrów



Tolerancja średnicy otworu IT6/IT7:

- Możliwość wyboru średnicy w krokach co 0,001 mm
- W zależności od zakresu średnicy, dostępne od tolerancji IT6/IT7
- > Ø30,000 IT6 | ≤ Ø30,000 IT7

Specyfikacja:

HPR110Ø[średnica][tolerancja]MF1G-HP625

Tolerancja średnicy otworu < IT6/IT7:

- Tolerancje mniejsze niż IT6/IT7 dostępne jako specjalna średnica narzędzia (wariant G – patrz strona 373)

Specyfikacja wariantu G:

HPR110GØ[średnica][tolerancja]MF1G-HP625

Wymiary typoszeregu z możliwością konfiguracji parametrów IT6/IT7

d1	l4	l5	Wielkość HFS	z	Tolerancja
15,600 - 18,590	14	-	10	6	IT7
18,600 - 21,290	14,5	-	12	6	IT7
21,300 - 23,990	15,5	-	14	6	IT7
24,000 - 29,990	16	-	16	6	IT7
30,000 - 39,990	17	-	20	8	IT6
40,000 - 50,700	19	-	24	8	IT6
50,710 - 65,000	25	-	24	8	IT6

Przykład tolerancji IT7:

HPR110Ø16.350H7MF1G-HP625

Średnica otworu d₁ = 16,350 H7

Przykład wariantu G:

HPR110GØ16.350-7MF1G-HP625

Średnica specjalna narzędzia d₁ = 16,350 -5 μm

Wymiary podano w mm.

Odpowiednie uchwyty wymiennej głowicy HFS od strony 460.

Zalecane parametry skrawania – patrz koniec rozdziału.

Rozwiertak z wymienną głowicą HPR

Wersja stała, rowek lewoskrętny, do wykonywania otworu przelotowego
HPR110

Wersja:

Średnica rozwiertaka:

15,600 – 65,000 mm

Nakrój:

MF1G

Materiał skrawający:

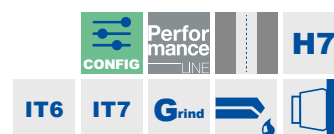
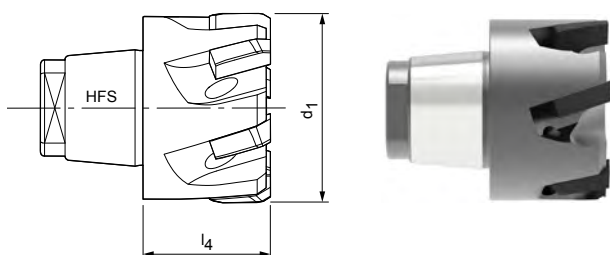
 Węglik spiekany z
powłoką PVD

Magazynowa seria preferowana w tolerancji H7

d ₁ H7	Wielkość HFS	Wymiary		Specyfikacja	Nr materiałowy
		l ₄	z		
19,000	12	14,5	6	HPR110Ø19H7MF1G-HP421	30710291
20,000	12	14,5	6	HPR110Ø20H7MF1G-HP421	30401369
22,000	14	15,5	6	HPR110Ø22H7MF1G-HP421	30710293
23,000	14	15,5	6	HPR110Ø23H7MF1G-HP421	30710294
24,000	16	16	6	HPR110Ø24H7MF1G-HP421	30710295
25,000	16	16	6	HPR110Ø25H7MF1G-HP421	30318503
26,000	16	16	6	HPR110Ø26H7MF1G-HP421	30710296
27,000	16	16	6	HPR110Ø27H7MF1G-HP421	30710297
28,000	16	16	6	HPR110Ø28H7MF1G-HP421	30710298
30,000	20	17	8	HPR110Ø30H7MF1G-HP421	30576508
31,000	20	17	8	HPR110Ø31H7MF1G-HP421	30710300
32,000	20	17	8	HPR110Ø32H7MF1G-HP421	30671985
33,000	20	17	8	HPR110Ø33H7MF1G-HP421	30710301
34,000	20	17	8	HPR110Ø34H7MF1G-HP421	30710302
35,000	20	17	8	HPR110Ø35H7MF1G-HP421	30710303
39,000	20	17	8	HPR110Ø39H7MF1G-HP421	30710307
40,000	24	19	8	HPR110Ø40H7MF1G-HP421	30498368

Wymiary podano w mm.

Odpowiednie uchwyty wymiennej głowicy HFS od strony 460.

Zalecane parametry skrawania – patrz koniec rozdziału.

HPR110 | Wersja stała, rowek lewoskrętny

Możliwość konfiguracji parametrów

**Tolerancja średnicy otworu IT6/IT7:**

- Możliwość wyboru średnicy w krokach co 0,001 mm
- W zależności od zakresu średnicy, dostępne od tolerancji IT6/IT7
- > Ø30,000 IT6 | ≤ Ø30,000 IT7

**Specyfikacja:**

HPR110Ø[średnica][tolerancja]MF1G-HP421

Tolerancja średnicy otworu < IT6/IT7:

- Tolerancje mniejsze niż IT6/IT7 dostępne jako specjalna średnica narzędzia (wariant G – patrz strona 373)

Specyfikacja wariantu G:

HPR110GØ[średnica][tolerancja]MF1G-HP421

Wymiary typoszeregu z możliwością konfiguracji parametrów IT6/IT7

d1	l ₄	l ₅	Wielkość HFS	z	Tolerancja
15,600 - 18,590	14	-	10	6	IT7
18,600 - 21,290	14,5	-	12	6	IT7
21,300 - 23,990	15,5	-	14	6	IT7
24,000 - 29,990	16	-	16	6	IT7
30,000 - 39,990	17	-	20	8	IT6
40,000 - 50,700	19	-	24	8	IT6
50,710 - 65,000	25	-	24	8	IT6

Przykład tolerancji IT7:

HPR110Ø16.350H7MF1G-HP421

Średnica otworu d₁ = 16,350 H7**Przykład wariantu G:**

HPR110GØ16.350-5MF1G-HP421

Średnica specjalna narzędzia d₁ = 16,350 -5 μm

Rozwiertak z wymienną głowicą HPR

Wersja monolityczna, prosty rowek wiórowy, do obróbki otworu nieprzewodowego
HPR180

Wersja:

Średnica rozwiertaka:

7,000 - 21,290 mm

Nakrój:

ML2G

Materiał skrawający:

CU134

Cermet bez powłoki

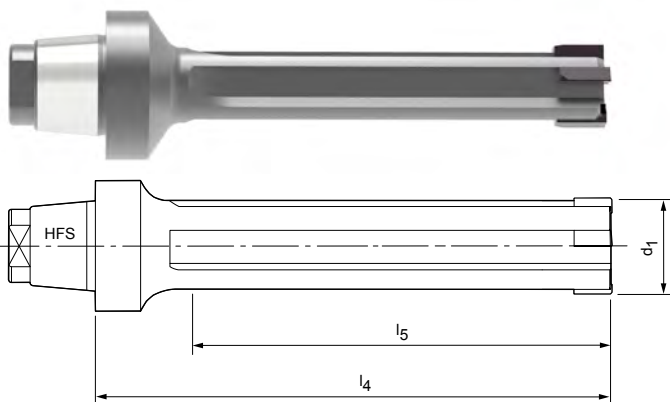

Możliwość konfiguracji parametrów

Tolerancja średnicy otworu IT7:

- Możliwość wyboru średnicy w krokach co 0,001 mm
- Dostępne od tolerancji IT7

Specyfikacja:

HPR180Ø[średnica][tolerancja]ML2G-CU134

Tolerancja średnicy otworu < IT7:

- Tolerancje mniejsze niż IT7 dostępne jako specjalna średnica narzędzia (wariant G – patrz strona 373)

Specyfikacja wariantu G:

HPR180GØ[średnica][tolerancja]ML2G-CU134

Wymiary typoszeregu z możliwością konfiguracji parametrów IT7

d1	l ₄	l ₅	Wielkość HFS	z
7,000 - 14,590	60	40	12	4
14,600 - 21,290	60	40	12	6

Przykład tolerancji IT7:

HPR180Ø16.350H7ML2G-CU134

 Średnica otworu $d_1 = 16,350 \text{ H7}$
Przykład wariantu G:

HPR180GØ16.350-3ML2G-CU134

 Średnica specjalna narzędzia $d_1 = 16,350 -3 \mu\text{m}$

Wymiary podano w mm.

Odpowiednie uchwyty wymiennej głowicy HFS od strony 460.

Zalecane parametry skrawania – patrz koniec rozdziału.

Rozwiertak z wymienną głowicą HPR

Wersja stała, prosty rowek wiórowy, do obróbki otworu nieprzelotowego
HPR180

Wersja:
Średnica rozwiertaka: 7,000 - 21,290 mm
Nakrój: ML2G
Materiał skrawający: HP421
Węglik spiekany z powłoką PVD

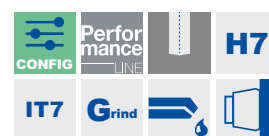
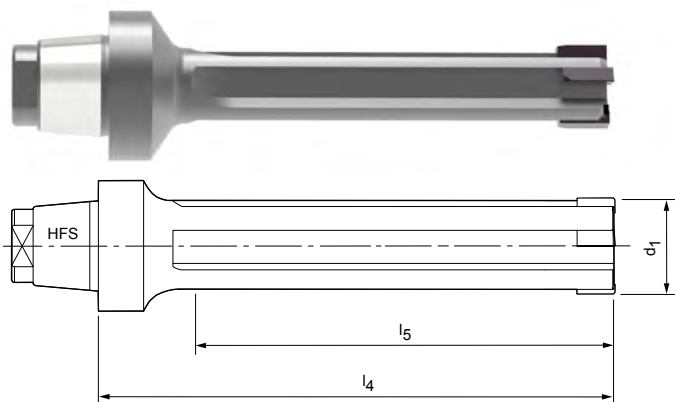

Magazyonowa seria preferowana w tolerancji H7

d ₁ H7	Wielkość HFS	Wymiary			Specyfikacja	Nr materiałowy
		l ₄	l ₅	z		
10,000	12	60	40	4	HPR180Ø10H7ML2G-HP421	30710208
12,000	12	60	40	4	HPR180Ø12H7ML2G-HP421	30710210
14,000	12	60	40	4	HPR180Ø14H7ML2G-HP421	30710212
16,000	12	60	40	6	HPR180Ø16H7ML2G-HP421	30710214
18,000	12	60	40	6	HPR180Ø18H7ML2G-HP421	30710216
19,000	12	60	40	6	HPR180Ø19H7ML2G-HP421	30710217
20,000	12	60	40	6	HPR180Ø20H7ML2G-HP421	30710218

Możliwość konfiguracji parametrów



Tolerancja średnicy otworu IT7:

- Możliwość wyboru średnicy w krokach co 0,001 mm
- Dostępne od tolerancji IT7

Specyfikacja:

HPR180Ø[średnica][tolerancja]ML2G-HP421

Tolerancja średnicy otworu < IT7:

- Tolerancje mniejsze niż IT7 dostępne jako specjalna średnica narzędzia (wariant G – patrz strona 373)

Specyfikacja wariantu G:

HPR180GØ[średnica][tolerancja]ML2G-HP421

Wymiary typoszeregu z możliwością konfiguracji parametrów IT7

d ₁	l ₄	l ₅	Wielkość HFS	z
7,000 - 14,590	60	40	12	4
14,600 - 21,290	60	40	12	6

Przykład tolerancji IT7:

HPR180Ø16.350H7ML2G-HP421

Średnica otworu d₁ = 16,350 H7

Przykład wariantu G:

HPR180GØ16.350-5ML2G-HP421

Średnica specjalna narzędzia d₁ = 16,350 -5 μm

Wymiary podano w mm.

Odpowiednie uchwyty wymiennej głowicy HFS od strony 460.

Zalecane parametry skrawania – patrz koniec rozdziału.

Rozwiertak z wymienną głowicą HPR

Wersja stała, prosty rowek wiórowy, do obróbki otworu nieprzelotowego
HPR180

Wersja:

Średnica rozwiertaka:

7,000 - 21,290 mm

Nakrój:

M02G

Materiał skrawający:

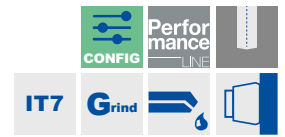
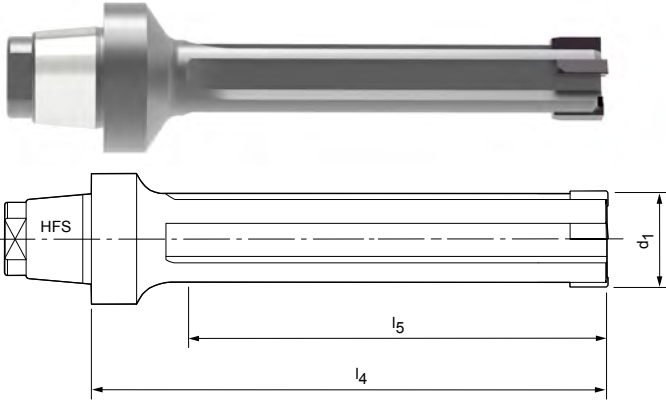
 HP421
Węglik spiekany z
powłoką PVD

Możliwość konfiguracji parametrów

Tolerancja średnicy otworu IT7:

- Możliwość wyboru średnicy w krokach co 0,001 mm
- Dostępne od tolerancji IT7

Specyfikacja:

HPR180Ø[średnica][tolerancja]M02G-HP421

Tolerancja średnicy otworu < IT7:

- Tolerancje mniejsze niż IT7 dostępne jako specjalna średnica narzędzia (wariant G – patrz strona 373)

Specyfikacja wariantu G:

HPR180GØ[średnica][tolerancja]M02G-HP421

Wymiary typoszeregu z możliwością konfiguracji parametrów IT7

d1	l ₄	l ₅	Wielkość HFS	z
7,000 - 14,590	60	40	12	4
14,600 - 21,290	60	40	12	6

Przykład tolerancji IT7:

HPR180Ø16.350H7M02G-HP421

 Średnica otworu $d_1 = 16,350 \text{ H7}$
Przykład wariantu G:

HPR180GØ16.350-5M02G-HP421

 Średnica specjalna narzędzia $d_1 = 16,350 -5 \mu\text{m}$

Wymiary podano w mm.

Odpowiednie uchwyty wymiennej głowicy HFS od strony 460.

Zalecane parametry skrawania – patrz koniec rozdziału.

Rozwiertak z wymienną głowicą HPR

Wersja stała, prosty rowek wiórowy, do obróbki otworu nieprzelotowego
HPR180

Wersja:
Średnica rozwiertaka: 7,000 - 21,290 mm
Nakrój: MC1G
Materiał skrawający: CP134
Cermet z powłoką PVD

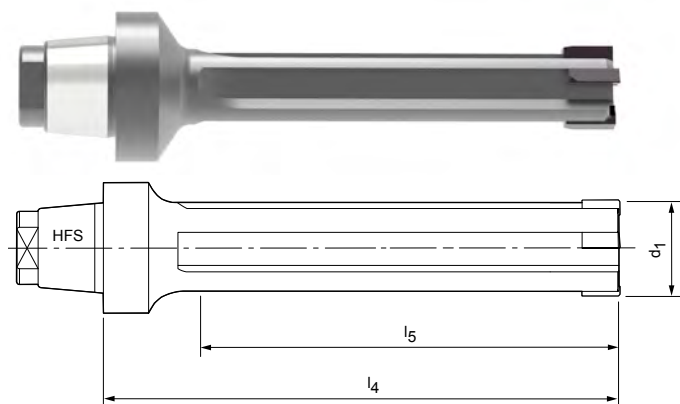

Możliwość konfiguracji parametrów



Tolerancja średnicy otworu IT7:

- Możliwość wyboru średnicy w krokach co 0,001 mm
- Dostępne od tolerancji IT7

Specyfikacja:

HPR180Ø[średnica][tolerancja]MC1G-CP134

Tolerancja średnicy otworu < IT7:

- Tolerancje mniejsze niż IT7 dostępne jako specjalna średnica narzędzia (wariant G – patrz strona 373)

Specyfikacja wariantu G:

HPR180GØ[średnica][tolerancja]MC1G-CP134

Wymiary typoszeregu z możliwością konfiguracji parametrów IT7

d1	l ₄	l ₅	Wielkość HFS	z
7,000 - 14,590	60	40	12	4
14,600 - 21,290	60	40	12	6

Przykład tolerancji IT7:

HPR180Ø16.350H7MC1G-CP134

Średnica otworu d₁ = 16,350 H7

Przykład wariantu G:

HPR180GØ16.350-5MC1G-CP134

Średnica specjalna narzędzia d₁ = 16,350 -5 μm

Wymiary podano w mm.

* do powierzchni R_a < 2 μm

Odpowiednie uchwyty wymiennej głowicy HFS od strony 460.

Zalecane parametry skrawania – patrz koniec rozdziału.

Rozwiertak z wymienną głowicą HPR

Wersja stała, prosty rowek wiórowy, do obróbki otworu nieprzelotowego
HPR180

Wersja:

Średnica rozwiertaka:

7,000 - 21,290 mm

Nakrój:

MC1G

Materiał skrawający:

Węgiel spiekany z
powłoką CVD

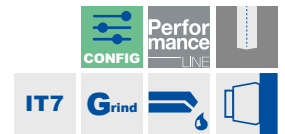
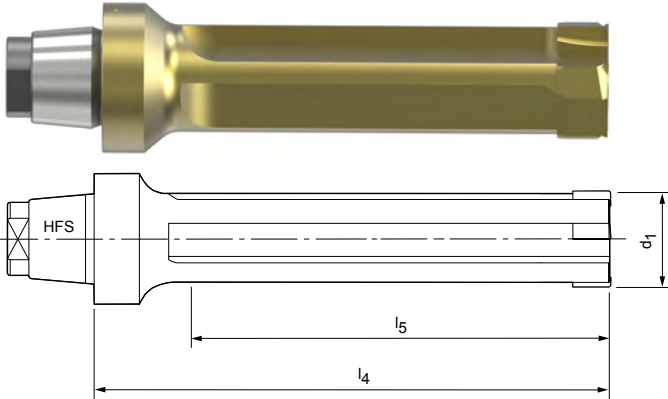

Możliwość konfiguracji parametrów



Tolerancja średnicy otworu IT7:

- Możliwość wyboru średnicy w krokach co 0,001 mm
- Dostępne od tolerancji IT7

Specyfikacja:

HPR180Ø[średnica][tolerancja]MC1G-HC419

Tolerancja średnicy otworu < IT7:

- Tolerancje mniejsze niż IT7 dostępne jako specjalna średnica narzędzia (wariant G – patrz strona 373)

Specyfikacja wariantu G:

HPR180GØ[średnica][tolerancja]MC1G-HC419

Wymiary typoszeregu z możliwością konfiguracji parametrów IT7

d1	l ₄	l ₅	Wielkość HFS	z
7,000 - 14,590	60	40	12	4
14,600 - 21,290	60	40	12	6

Przykład tolerancji IT7:

HPR180Ø16.350H7MC1G-HC419

Średnica otworu $d_1 = 16,350 \text{ H7}$

Przykład wariantu G:

HPR180GØ16.350-7MC1G-HC419

Średnica specjalna narzędzia $d_1 = 16,350 -7 \mu\text{m}$

Wymiary podano w mm.

* do powierzchni $R_a > 2 \mu\text{m}$

Odpowiednie uchwyty wymiennej głowicy HFS od strony 460.

Zalecane parametry skrawania – patrz koniec rozdziału.

Rozwiertak z wymienną głowicą HPR

Wersja stała, prosty rowek wiórowy, do obróbki otworu nieprzelotowego
HPR180

Wersja:
Średnica rozwiertaka: 7,000 - 21,290 mm
Nakrój: MC1G
Materiał skrawający: HP421
Węglik spiekany z powłoką PVD

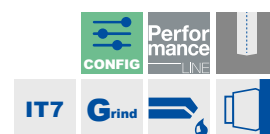
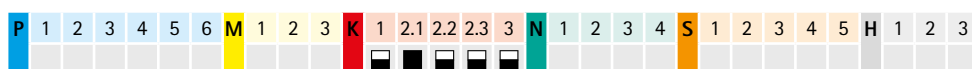
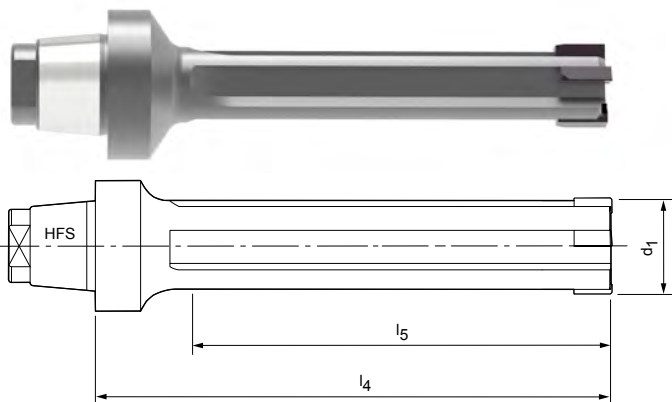

Możliwość konfiguracji parametrów



Tolerancja średnicy otworu IT7:

- Możliwość wyboru średnicy w krokach co 0,001 mm
- Dostępne od tolerancji IT7

Specyfikacja:

HPR180Ø[średnica][tolerancja]MC1G-HP421

Tolerancja średnicy otworu < IT7:

- Tolerancje mniejsze niż IT7 dostępne jako specjalna średnica narzędzia (wariant G – patrz strona 373)

Specyfikacja wariantu G:

HPR180GØ[średnica][tolerancja]MC1G-HP421

Wymiary typoszeregu z możliwością konfiguracji parametrów IT7

d1	l ₄	l ₅	Wielkość HFS	z
7,000 - 14,590	60	40	12	4
14,600 - 21,290	60	40	12	6

Przykład tolerancji IT7:

HPR180Ø16.350H7MC1G-HP421

Średnica otworu d₁ = 16,350 H7

Przykład wariantu G:

HPR180GØ16.350-5MC1G-HP421

Średnica specjalna narzędzia d₁ = 16,350 -5 μm

Wymiary podano w mm.

Odpowiednie uchwyty wymiennej głowicy HFS od strony 460.

Zalecane parametry skrawania – patrz koniec rozdziału.

Rozwiertak z wymienną głowicą HPR

Wersja stała, prosty rowek wiórowy, do obróbki otworu nieprzelotowego
HPR180

Wersja:

Średnica rozwiertaka:

7,000 - 21,290 mm

Nakrój:

MC1G

Materiał skrawający:

HP423

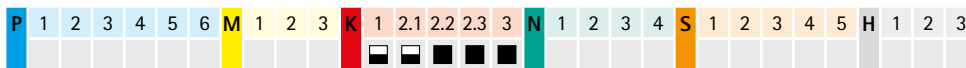
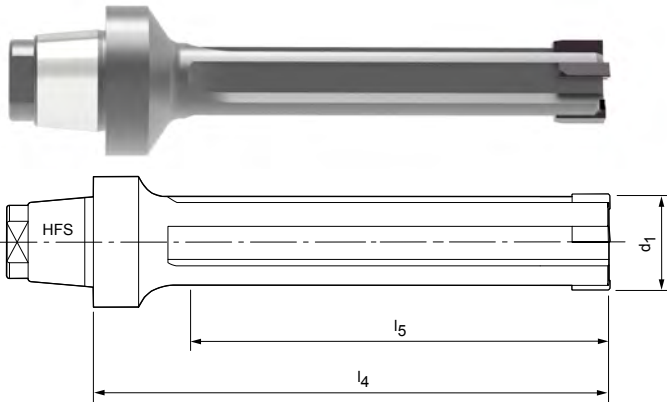
 Węglik spiekany z
powłoką PVD

Możliwość konfiguracji parametrów

Tolerancja średnicy otworu IT7:

- Możliwość wyboru średnicy w krokach co 0,001 mm
- Dostępne od tolerancji IT7

Specyfikacja:

HPR180Ø[średnica][tolerancja]MC1G-HP423

Tolerancja średnicy otworu < IT7:

- Tolerancje mniejsze niż IT7 dostępne jako specjalna średnica narzędzia (wariant G – patrz strona 373)

Specyfikacja wariantu G:

HPR180GØ[średnica][tolerancja]MC1G-HP423

Wymiary typoszeregu z możliwością konfiguracji parametrów IT7

d1	l ₄	l ₅	Wielkość HFS	z
7,000 - 14,590	60	40	12	4
14,600 - 21,290	60	40	12	6

Przykład tolerancji IT7:

HPR180Ø16.350H7MC1G-HP423

 Średnica otworu d₁ = 16,350 H7

Przykład wariantu G:

HPR180GØ16.350-8MC1G-HP423

 Średnica specjalna narzędzia d₁ = 16,350 -7 μm

Wymiary podano w mm.

Odpowiednie uchwyty wymiennej głowicy HFS od strony 460.

Zalecane parametry skrawania – patrz koniec rozdziału.

Rozwiertak z wymienną głowicą HPR

Wersja stała, prosty rowek wiórowy, do obróbki otworu nieprzelotowego
HPR180

Wersja:
Średnica rozwiertaka: 7,000 - 21,290 mm
Nakrój: MA0A
Materiał skrawający: PU620
Z ostrzami PCD

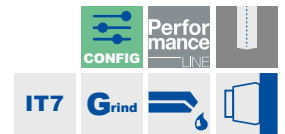
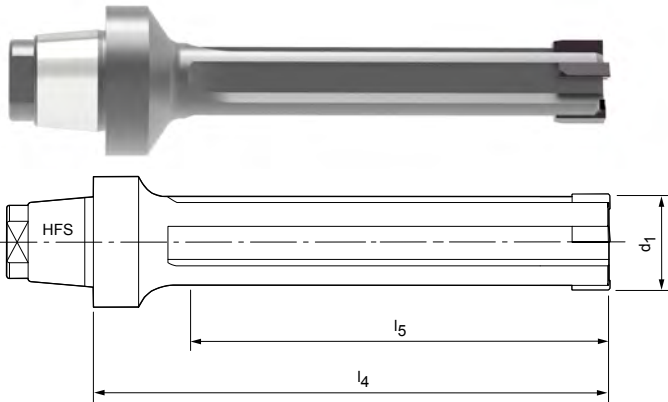

Możliwość konfiguracji parametrów



Tolerancja średnicy otworu IT7:

- Możliwość wyboru średnicy w krokach co 0,001 mm
- Dostępne od tolerancji IT7

Specyfikacja:

HPR180Ø[średnica][tolerancja]MA0A-PU620

Tolerancja średnicy otworu < IT7:

- Tolerancje mniejsze niż IT7 dostępne jako specjalna średnica narzędzia (wariant G – patrz strona 373)

Specyfikacja wariantu G:

HPR180GØ[średnica][tolerancja]MA0A-PU620

Wymiary typoszeregu z możliwością konfiguracji parametrów IT7

d1	l ₄	l ₅	Wielkość HFS	z
7,000 - 14,590	60	40	12	4
14,600 - 21,290	60	40	12	6

Przykład tolerancji IT7:

HPR180Ø16.350H7MA0A-PU620

Średnica otworu d₁ = 16,350 H7

Przykład wariantu G:

HPR180GØ16.350-3MA0A-PU620

Średnica specjalna narzędzia d₁ = 16,350 -3 μm

Wymiary podano w mm.

Odpowiednie uchwyty wymiennej głowicy HFS od strony 460.

Zalecane parametry skrawania – patrz koniec rozdziału.

Rozwiertak z wymienną głowicą HPR

Wersja stała, prosty rowek wiórowy, do obróbki otworu nieprzelotowego
HPR180

Wersja:

Średnica rozwiertaka:

7,000 - 21,290 mm

Nakrój:

M02G

Materiał skrawający:

Węgiel spiekany z

powłoką PVD

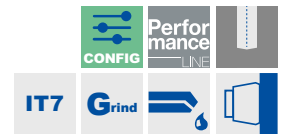
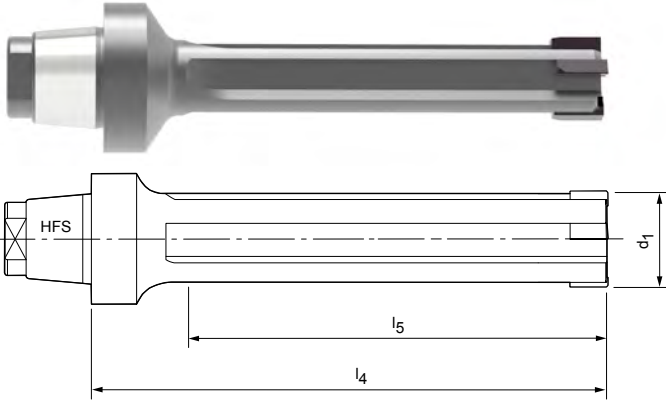

Możliwość konfiguracji parametrów

Tolerancja średnicy otworu IT7:

- Możliwość wyboru średnicy w krokach co 0,001 mm
- Dostępne od tolerancji IT7

Specyfikacja:

HPR180Ø[średnica][tolerancja]M02G-HP625

Tolerancja średnicy otworu < IT7:

- Tolerancje mniejsze niż IT7 dostępne jako specjalna średnica narzędzia (wariant G – patrz strona 373)

Specyfikacja wariantu G:

HPR180GØ[średnica][tolerancja]M02G-HP625

Wymiary typoszeregu z możliwością konfiguracji parametrów IT7

d1	l ₄	l ₅	Wielkość HFS	z
7,000 - 14,590	60	40	12	4
14,600 - 21,290	60	40	12	6

Przykład tolerancji IT7:

HPR180Ø16.350H7M02G-HP625

 Średnica otworu d₁ = 16,350 H7

Przykład wariantu G:

HPR180GØ16.350-7M02G-HP625

 Średnica specjalna narzędzia d₁ = 16,350 -5 μm

Wymiary podano w mm.

Odpowiednie uchwyty wymiennej głowicy HFS od strony 460.

Zalecane parametry skrawania – patrz koniec rozdziału.

Rozwiertak z wymienną głowicą HPR

Wersja monolityczna, prosty rowek wiórowy, do obróbki otworu nieprzewodowego
HPR150

Wersja:

Średnica rozwiertaka: 16,600 - 65,000 mm
Nakrój: ML2G
Materiał skrawający: CU134
Cermet bez powłoki

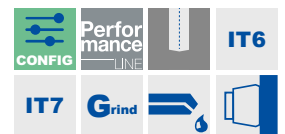
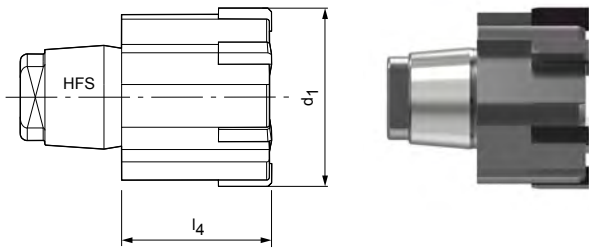

Możliwość konfiguracji parametrów



Tolerancja średnicy otworu IT6/IT7:

- Możliwość wyboru średnicy w krokach co 0,001 mm
- W zależności od zakresu średnicy, dostępne od tolerancji IT6/IT7
- > Ø30,000 IT6 | ≤ Ø30,000 IT7

Specyfikacja:

HPR150Ø[średnica][tolerancja]ML2G-CU134

Tolerancja średnicy otworu < IT6/IT7:

- Tolerancje mniejsze niż IT6/IT7 dostępne jako specjalna średnica narzędzia (wariant G – patrz strona 373)

Specyfikacja wariantu G:

HPR150GØ[średnica][tolerancja]ML2G-CU134

Wymiary typoszeregu z możliwością konfiguracji parametrów IT6/IT7

d1	l4	l5	Wielkość HFS	z	Tolerancja
16,600 - 21,290	14	-	10	6	IT7
21,300 - 24,990	15,5	-	12	6	IT7
25,000 - 28,990	15,5	-	14	6	IT7
29,000 - 29,990	17	-	16	6	IT7
30,000 - 36,990	17	-	16	6	IT6
37,000 - 44,990	17	-	20	8	IT6
45,000 - 50,700	19	-	24	8	IT6
50,710 - 65,000	25	-	24	8	IT6

Przykład tolerancji ≥ IT6:

HPR150Ø37.350H6ML2G-CU134

Średnica otworu d₁ = 37,350 H6

Przykład wariantu G:

HPR150GØ37.350-3ML2G-CU134

Średnica specjalna narzędzia d₁ = 37,350 -3 μm

Wymiary podano w mm.

Odpowiednie uchwyty wymiennej głowicy HFS od strony 460.

Zalecane parametry skrawania – patrz koniec rozdziału.

Rozwiertak z wymienną głowicą HPR

Wersja stała, prosty rowek wiórowy, do obróbki otworu nieprzelotowego
HPR150

Wersja:

Średnica rozwiertaka:

16,600 - 65,000 mm

Nakrój:

ML2G

Materiał skrawający:

HP421

Węglik spiekany z
powłoką PVD

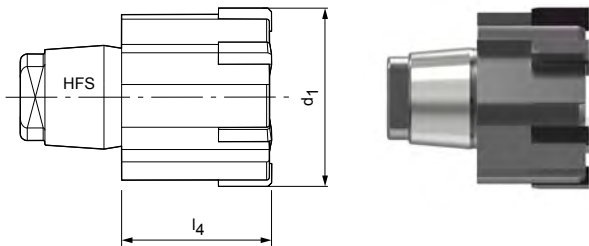

Magazynowa seria preferowana w tolerancji H7

d ₁ H7	Wielkość HFS	Wymiary		Specyfikacja	Nr materiałowy
		l ₄	z		
22,000	12	15,5	6	HPR150Ø22H7ML2G-HP421	30098915
24,000	12	15,5	6	HPR150Ø24H7ML2G-HP421	30329443
26,000	14	15,5	6	HPR150Ø26H7ML2G-HP421	30044823
28,000	14	15,5	6	HPR150Ø28H7ML2G-HP421	30710391
30,000	16	17	6	HPR150Ø30H7ML2G-HP421	30710393
32,000	16	17	6	HPR150Ø32H7ML2G-HP421	30462441
40,000	20	17	8	HPR150Ø40H7ML2G-HP421	30586834

Możliwość konfiguracji parametrów



Tolerancja średnicy otworu IT6/IT7:

- Możliwość wyboru średnicy w krokach co 0,001 mm
- W zależności od zakresu średnicy, dostępne od tolerancji IT6/IT7
- > Ø30,000 IT6 | ≤ Ø30,000 IT7

Specyfikacja:

HPR150Ø[średnica][tolerancja]ML2G-HP421

Tolerancja średnicy otworu < IT6/IT7:

- Tolerancje mniejsze niż IT6/IT7 dostępne jako specjalna średnica narzędzia (wariant G – patrz strona 373)

Specyfikacja wariantu G:

HPR150GØ[średnica][tolerancja]ML2G-HP421

Wymiary typoszeregu z możliwością konfiguracji parametrów IT6/IT7

d ₁	l ₄	l ₅	Wielkość HFS	z	Tolerancja
16,600 - 21,290	14	-	10	6	IT7
21,300 - 24,990	15,5	-	12	6	IT7
25,000 - 28,990	15,5	-	14	6	IT7
29,000 - 29,990	17	-	16	6	IT7
30,000 - 36,990	17	-	16	6	IT6
37,000 - 44,990	17	-	20	8	IT6
45,000 - 50,700	19	-	24	8	IT6
50,710 - 65,000	25	-	24	8	IT6

Przykład tolerancji ≥ IT6:

HPR150Ø37.350H6ML2G-HP421

Średnica otworu d₁ = 37,350 H6

Przykład wariantu G:

HPR150GØ37.350-5ML2G-HP421

Średnica specjalna narzędzia d₁ = 37,350 -5 μm

Wymiary podano w mm.

Odpowiednie uchwyty wymiennej głowicy HFS od strony 460.

Zalecane parametry skrawania – patrz koniec rozdziału.

Rozwiertak z wymienną głowicą HPR

Wersja stała, prosty rowek wiórowy, do obróbki otworu nieprzelotowego
HPR150

Wersja:
Średnica rozwiertaka: 16,600 - 65,000 mm
Nakrój: M02G
Materiał skrawający: HP421
Węglik spiekany z powłoką PVD

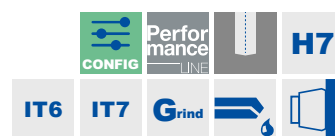
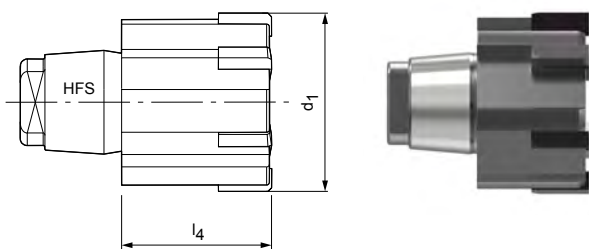

Magazynowa seria preferowana w tolerancji H7

d ₁ H7	Wielkość HFS	Wymiary		Specyfikacja	Nr materiałowy
		l ₄	z		
20,000	10	14	6	HPR150Ø20H7M02G-HP421	30975790
26,000	14	15,5	6	HPR150Ø26H7M02G-HP421	30975773
28,000	14	15,5	6	HPR150Ø28H7M02G-HP421	30843363
30,000	16	17	6	HPR150Ø30H7M02G-HP421	30975775
32,000	16	17	6	HPR150Ø32H7M02G-HP421	30975776
35,000	16	17	6	HPR150Ø35H7M02G-HP421	30976284
40,000	20	17	8	HPR150Ø40H7M02G-HP421	30898813

Możliwość konfiguracji parametrów

Tolerancja średnicy otworu IT6/IT7:

- Możliwość wyboru średnicy w krokach co 0,001 mm
- W zależności od zakresu średnicy, dostępne od tolerancji IT6/IT7
- > Ø30,000 IT6 | ≤ Ø30,000 IT7

Specyfikacja:
HPR150Ø[średnica][tolerancja]M02G-HP421

Tolerancja średnicy otworu < IT6/IT7:

- Tolerancje mniejsze niż IT6/IT7 dostępne jako specjalna średnica narzędzia (wariant G – patrz strona 373)

Specyfikacja wariantu G:
HPR150GØ[średnica][tolerancja]M02G-HP421

Wymiary typoszeregu z możliwością konfiguracji parametrów IT6/IT7

d ₁	l ₄	l ₅	Wielkość HFS	z	Tolerancja
16,600 - 21,290	14	-	10	6	IT7
21,300 - 24,990	15,5	-	12	6	IT7
25,000 - 28,990	15,5	-	14	6	IT7
29,000 - 29,990	17	-	16	6	IT7
30,000 - 36,990	17	-	16	6	IT6
37,000 - 44,990	17	-	20	8	IT6
45,000 - 50,700	19	-	24	8	IT6
50,710 - 65,000	25	-	24	8	IT6

Przykład tolerancji ≥ IT6:
HPR150Ø37.350H6M02G-HP421

Średnica otworu d₁ = 37,350 H6

Przykład wariantu G:
HPR150GØ37.350-5M02G-HP421

Średnica specjalna narzędzia d₁ = 37,350 -5 μm

Wymiary podano w mm.
Odpowiednie uchwyty wymiennej głowicy HFS od strony 460.
Zalecane parametry skrawania – patrz koniec rozdziału.

Rozwiertak z wymienną głowicą HPR

Wersja stała, prosty rowek wiórowy, do obróbki otworu nieprzelotowego
HPR150

Wersja:

Średnica rozwiertaka:

16,600 – 65,000 mm

Nakrój:

MC1G

Materiał skrawający:

CP134

Cermet z powłoką PVD

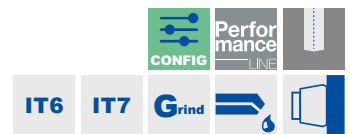
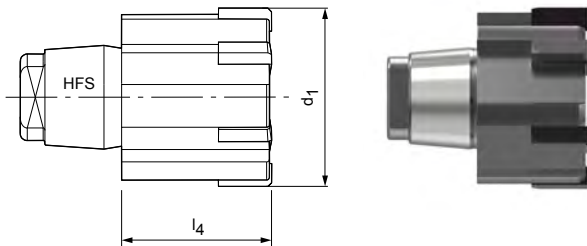

Możliwość konfiguracji parametrów

Tolerancja średnicy otworu IT6/IT7:

- Możliwość wyboru średnicy w krokach co 0,001 mm
- W zależności od zakresu średnicy, dostępne od tolerancji IT6/IT7
- > Ø30,000 IT6 | ≤ Ø30,000 IT7

Specyfikacja:

HPR150Ø[średnica][tolerancja]MC1G-CP134

Tolerancja średnicy otworu < IT6/IT7:

- Tolerancje mniejsze niż IT6/IT7 dostępne jako specjalna średnica narzędzia (wariant G – patrz strona 373)

Specyfikacja wariantu G:

HPR150GØ[średnica][tolerancja]MC1G-CP134

Wymiary typoszeregu z możliwością konfiguracji parametrów IT6/IT7

d1	l ₄	l ₅	Wielkość HFS	z	Tolerancja
16,600 – 21,290	14	–	10	6	IT7
21,300 – 24,990	15,5	–	12	6	IT7
25,000 – 28,990	15,5	–	14	6	IT7
29,000 – 29,990	17	–	16	6	IT7
30,000 – 36,990	17	–	16	6	IT6
37,000 – 44,990	17	–	20	8	IT6
45,000 – 50,700	19	–	24	8	IT6
50,710 – 65,000	25	–	24	8	IT6

Przykład tolerancji ≥ IT6:

HPR150Ø37.350H6MC1G-CP134

 Średnica otworu d₁ = 37,350 H6

Przykład wariantu G:

HPR150GØ37.350-5MC1G-CP134

 Średnica specjalna narzędzia d₁ = 37,350 -5 μm

Wymiary podano w mm.

 * do powierzchni R_a < 2 μm

Odpowiednie uchwyty wymiennej głowicy HFS od strony 460.

Zalecane parametry skrawania – patrz koniec rozdziału.

Rozwiertak z wymienną głowicą HPR

Wersja stała, prosty rowek wiórowy, do obróbki otworu nieprzelotowego
HPR150

Wersja:

Średnica rozwiertaka: 16,600 - 65,000 mm
Nakrój: MC1G
Materiał skrawający: HC419
Węglik spiekany z powłoką CVD

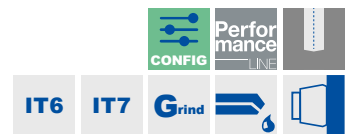
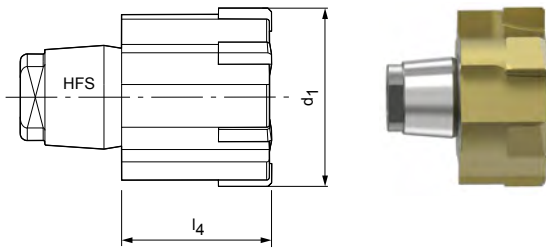

Możliwość konfiguracji parametrów



Tolerancja średnicy otworu IT6/IT7:

- Możliwość wyboru średnicy w krokach co 0,001 mm
- W zależności od zakresu średnicy, dostępne od tolerancji IT6/IT7
- > Ø30,000 IT6 | ≤ Ø30,000 IT7

Specyfikacja:

HPR150Ø[średnica][tolerancja]MC1G-HC419

Tolerancja średnicy otworu < IT6/IT7:

- Tolerancje mniejsze niż IT6/IT7 dostępne jako specjalna średnica narzędzia (wariant G – patrz strona 373)

Specyfikacja wariantu G:

HPR150GØ[średnica][tolerancja]MC1G-HC419

Wymiary typoszeregu z możliwością konfiguracji parametrów IT6/IT7

d1	l4	l5	Wielkość HFS	z	Tolerancja
16,600 - 21,290	14	-	10	6	IT7
21,300 - 24,990	15,5	-	12	6	IT7
25,000 - 28,990	15,5	-	14	6	IT7
29,000 - 29,990	17	-	16	6	IT7
30,000 - 36,990	17	-	16	6	IT6
37,000 - 44,990	17	-	20	8	IT6
45,000 - 50,700	19	-	24	8	IT6
50,710 - 65,000	25	-	24	8	IT6

Przykład tolerancji ≥ IT6:

HPR150Ø37.350H6MC1G-HC419

Średnica otworu d₁ = 37,350 H6

Przykład wariantu G:

HPR150GØ37.350-7MC1G-HC419

Średnica specjalna narzędzia d₁ = 37,350 -7 μm

Wymiary podano w mm.

* do powierzchni R_a > 2 μm

Odpowiednie uchwyty wymiennej głowicy HFS od strony 460.

Zalecane parametry skrawania – patrz koniec rozdziału.

Rozwiertak z wymienną głowicą HPR

Wersja stała, prosty rowek wiórowy, do obróbki otworu nieprzelotowego
HPR150

Wersja:

Średnica rozwiertaka:

16,600 - 65,000 mm

Nakrój:

MC1G

Materiał skrawający:

HP421

Węglik spiekany z
powłoką PVD

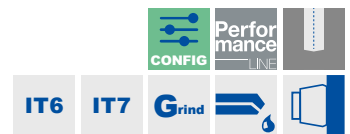
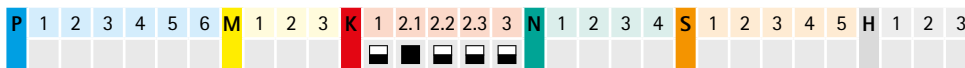
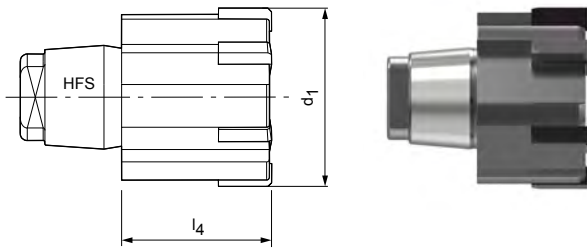

Możliwość konfiguracji parametrów



Tolerancja średnicy otworu IT6/IT7:

- Możliwość wyboru średnicy w krokach co 0,001 mm
- W zależności od zakresu średnicy, dostępne od tolerancji IT6/IT7
- > Ø30,000 IT6 | ≤ Ø30,000 IT7

Specyfikacja:

HPR150Ø[średnica][tolerancja]MC1G-HP421

Tolerancja średnicy otworu < IT6/IT7:

- Tolerancje mniejsze niż IT6/IT7 dostępne jako specjalna średnica narzędzia (wariant G – patrz strona 373)

Specyfikacja wariantu G:

HPR150GØ[średnica][tolerancja]MC1G-HP421

Wymiary typoszeregu z możliwością konfiguracji parametrów IT6/IT7

d1	l ₄	l ₅	Wielkość HFS	z	Tolerancja
16,600 - 21,290	14	-	10	6	IT7
21,300 - 24,990	15,5	-	12	6	IT7
25,000 - 28,990	15,5	-	14	6	IT7
29,000 - 29,990	17	-	16	6	IT7
30,000 - 36,990	17	-	16	6	IT6
37,000 - 44,990	17	-	20	8	IT6
45,000 - 50,700	19	-	24	8	IT6
50,710 - 65,000	25	-	24	8	IT6

Przykład tolerancji ≥ IT6:

HPR150Ø37.350H6MC1G-HP421

Średnica otworu d₁ = 37,350 H6

Przykład wariantu G:

HPR150GØ37.350-5MC1G-HP421

Średnica specjalna narzędzia d₁ = 37,350 -5 μm

Wymiary podano w mm.

Odpowiednie uchwyty wymiennej głowicy HFS od strony 460.

Zalecane parametry skrawania – patrz koniec rozdziału.

Rozwiertak z wymienną głowicą HPR

Wersja stała, prosty rowek wiórowy, do obróbki otworu nieprzelotowego
HPR150

Wersja:
Średnica rozwiertaka: 16,600 – 65,000 mm
Nakrój: MC1G
Materiał skrawający: HP423
Węglik spiekany z powłoką PVD

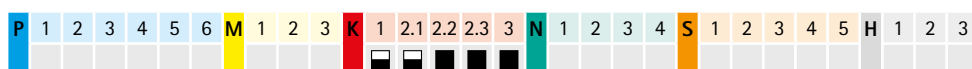
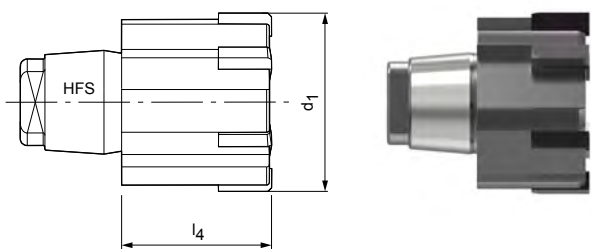

Możliwość konfiguracji parametrów



Tolerancja średnicy otworu IT6/IT7:

- Możliwość wyboru średnicy w krokach co 0,001 mm
- W zależności od zakresu średnicy, dostępne od tolerancji IT6/IT7
- > Ø30,000 IT6 | ≤ Ø30,000 IT7

Specyfikacja:

HPR150Ø[średnica][tolerancja]MC1G-HP423

Tolerancja średnicy otworu < IT6/IT7:

- Tolerancje mniejsze niż IT6/IT7 dostępne jako specjalna średnica narzędzia (wariant G – patrz strona 373)

Specyfikacja wariantu G:

HPR150GØ[średnica][tolerancja]MC1G-HP423

Wymiary typoszeregu z możliwością konfiguracji parametrów IT6/IT7

d1	l4	l5	Wielkość HFS	z	Tolerancja
16,600 - 21,290	14	-	10	6	IT7
21,300 - 24,990	15,5	-	12	6	IT7
25,000 - 28,990	15,5	-	14	6	IT7
29,000 - 29,990	17	-	16	6	IT7
30,000 - 36,990	17	-	16	6	IT6
37,000 - 44,990	17	-	20	8	IT6
45,000 - 50,700	19	-	24	8	IT6
50,710 - 65,000	25	-	24	8	IT6

Przykład tolerancji ≥ IT6:

HPR150Ø37.350H6MC1G-HP423

Średnica otworu $d_1 = 37,350 \text{ H6}$

Przykład wariantu G:

HPR150GØ37.350-8MC1G-HP423

Średnica specjalna narzędzia $d_1 = 37,350 -7 \mu\text{m}$

Wymiary podano w mm.

Odpowiednie uchwyty wymiennej głowicy HFS od strony 460.

Zalecane parametry skrawania – patrz koniec rozdziału.

Rozwiertak z wymienną głowicą HPR

Wersja stała, prosty rowek wiórowy, do obróbki otworu nieprzelotowego
HPR150

Wersja:

Średnica rozwiertaka:

16,600 – 65,000 mm

Nakrój:

MA0A

Materiał skrawający:

PU620

Z ostrzami PCD

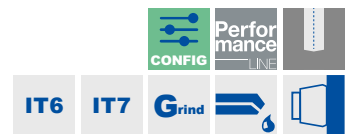
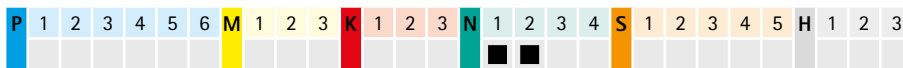
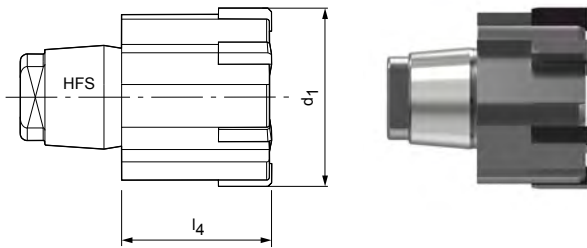

Możliwość konfiguracji parametrów

Tolerancja średnicy otworu IT6/IT7:

- Możliwość wyboru średnicy w krokach co 0,001 mm
- W zależności od zakresu średnicy, dostępne od tolerancji IT6/IT7
- > Ø30,000 IT6 | ≤ Ø30,000 IT7

Specyfikacja:

HPR150Ø[średnica][tolerancja]MA0A-PU620

Tolerancja średnicy otworu < IT6/IT7:

- Tolerancje mniejsze niż IT6/IT7 dostępne jako specjalna średnica narzędzia (wariant G – patrz strona 373)

Specyfikacja wariantu G:

HPR150GØ[średnica][tolerancja]MA0A-PU620

Wymiary typoszeregu z możliwością konfiguracji parametrów IT6/IT7

d1	l ₄	l ₅	Wielkość HFS	z	Tolerancja
16,600 – 21,290	14	–	10	6	IT7
21,300 – 24,990	15,5	–	12	6	IT7
25,000 – 28,990	15,5	–	14	6	IT7
29,000 – 29,990	17	–	16	6	IT7
30,000 – 36,990	17	–	16	6	IT6
37,000 – 44,990	17	–	20	8	IT6
45,000 – 50,700	19	–	24	8	IT6
50,710 – 65,000	25	–	24	8	IT6

Przykład tolerancji ≥ IT6:

HPR150Ø37.350H6MA0A-PU620

 Średnica otworu d₁ = 37,350 H6

Przykład wariantu G:

HPR150GØ37.350-3MA0A-PU620

 Średnica specjalna narzędzia d₁ = 37,350 -3 μm

Wymiary podano w mm.

Odpowiednie uchwyty wymiennej głowicy HFS od strony 460.

Zalecane parametry skrawania – patrz koniec rozdziału.

Rozwiertak z wymienną głowicą HPR

Wersja stała, prosty rowek wiórowy, do obróbki otworu nieprzelotowego
HPR150

Wersja:

Średnica rozwiertaka: 16,600 - 65,000 mm
Nakrój: M02G
Materiał skrawający: HP625
Węglik spiekany z powłoką PVD

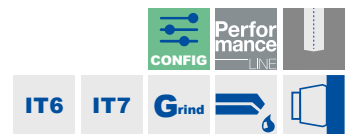
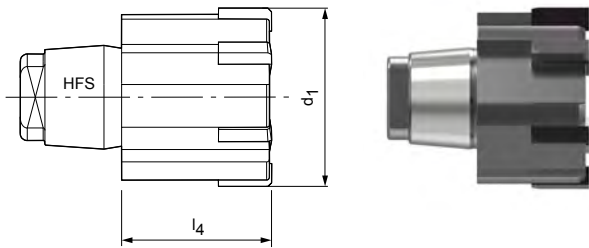

Możliwość konfiguracji parametrów



Tolerancja średnicy otworu IT6/IT7:

- Możliwość wyboru średnicy w krokach co 0,001 mm
- W zależności od zakresu średnicy, dostępne od tolerancji IT6/IT7
- > Ø30,000 IT6 | ≤ Ø30,000 IT7

Specyfikacja:

HPR150Ø[średnica][tolerancja]M02G-HP625

Tolerancja średnicy otworu < IT6/IT7:

- Tolerancje mniejsze niż IT6/IT7 dostępne jako specjalna średnica narzędzia (wariant G – patrz strona 373)

Specyfikacja wariantu G:

HPR150GØ[średnica][tolerancja]M02G-HP625

Wymiary typoszeregu z możliwością konfiguracji parametrów IT6/IT7

d1	l4	l5	Wielkość HFS	z	Tolerancja
16,600 - 21,290	14	-	10	6	IT7
21,300 - 24,990	15,5	-	12	6	IT7
25,000 - 28,990	15,5	-	14	6	IT7
29,000 - 29,990	17	-	16	6	IT7
30,000 - 36,990	17	-	16	6	IT6
37,000 - 44,990	17	-	20	8	IT6
45,000 - 50,700	19	-	24	8	IT6
50,710 - 65,000	25	-	24	8	IT6

Przykład tolerancji ≥ IT6:

HPR150Ø37.350H6M02G-HP625

Średnica otworu d₁ = 37,350 H6

Przykład wariantu G:

HPR150GØ37.350-7M02G-HP625

Średnica specjalna narzędzia d₁ = 37,350 -5 μm

Wymiary podano w mm.

Odpowiednie uchwyty wymiennej głowicy HFS od strony 460.

Zalecane parametry skrawania – patrz koniec rozdziału.

Rozwiertak z wymienną głowicą HPR

Wersja z precyzyzną regulacją, prosty rowek wiórowy, do wykonywania otworu przelotowego
HPR230

Wersja:

Średnica rozwiertaka:

7,000 - 18,590 mm

Nakrój:

MC1G

Materiał skrawający:

CP134

Cermet z powłoką PVD

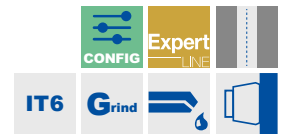
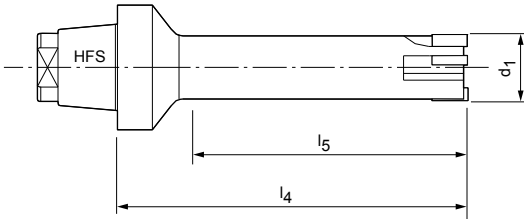

Możliwość konfiguracji parametrów

Tolerancja średnicy otworu IT6:

- Możliwość wyboru średnicy w krokach co 0,001 mm
- Dostępne w tolerancji IT6

Specyfikacja:

HPR230Ø[średnica][tolerancja]MC1G-CP134

Tolerancja średnicy otworu < IT6:

- Tolerancje mniejsze niż IT6 dostępne jako specjalna średnica narzędzia (wariant G – patrz strona 373)

Specyfikacja wariantu G:

HPR230GØ[średnica][tolerancja]MC1G-CP134

Wymiary typoszeru z możliwością konfiguracji parametrów IT6

d_1	l_4	l_5	Wielkość HFS	z
7,000 - 9,590	60	45	12	4
9,600 - 18,590	60	45	12	6

Przykład tolerancji \geq IT6:

HPR230Ø10.350H6MC1G-CP134

 Średnica otworu $d_1 = 10,350 \text{ H6}$
Przykład wariantu G:

HPR230GØ10.350+1-1MC1G-CP134

 Średnica specjalna narzędzia $d_1 = 10,350 + 1 \mu\text{m} - 1 \mu\text{m}$

Wymiary podano w mm.

 * do powierzchni $R_a < 2 \mu\text{m}$

Odpowiednie uchwyty wymiennej głowicy HFS od strony 460.

Zalecane parametry skrawania – patrz koniec rozdziału.

Rozwiertak z wymienną głowicą HPR

Wersja z precyzyzną regulacją, prosty rowek wiórowy, do wykonywania otworu przelotowego
HPR230

Wersja:

Średnica rozwiertaka:

7,000 - 18,590 mm

Nakrój:

MC1G

Materiał skrawający:

HP421

Węglik spiekany z powłoką PVD

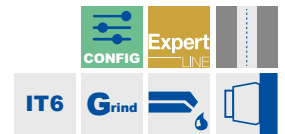
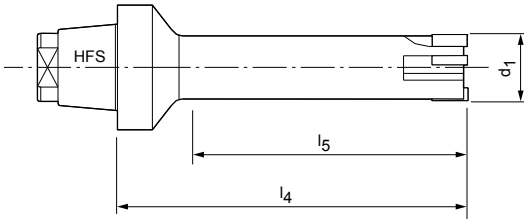

Możliwość konfiguracji parametrów



Tolerancja średnicy otworu IT6:

- Możliwość wyboru średnicy w krokach co 0,001 mm
- Dostępne w tolerancji IT6

Specyfikacja:

HPR230Ø[średnica][tolerancja]MC1G-HP421

Tolerancja średnicy otworu < IT6:

- Tolerancje mniejsze niż IT6 dostępne jako specjalna średnica narzędzia (wariant G – patrz strona 373)

Specyfikacja wariantu G:

HPR230GØ[średnica][tolerancja]MC1G-HP421

Wymiary typoszeregu z możliwością konfiguracji parametrów IT6

d ₁	l ₄	l ₅	Wielkość HFS	z
7,000 - 9,590	60	45	12	4
9,600 - 18,590	60	45	12	6

Przykład tolerancji ≥ IT6:

HPR230Ø10.350H6MC1G-HP421

Średnica otworu d₁ = 10,350 H6

Przykład wariantu G:

HPR230GØ10.350+1-1MC1G-HP421

Średnica specjalna narzędzia d₁ = 10,350 +1 μm -1 μm

Wymiary podano w mm.

Odpowiednie uchwyty wymiennej głowicy HFS od strony 460.

Zalecane parametry skrawania – patrz koniec rozdziału.

Rozwiertak z wymienną głowicą HPR

Wersja z precyzyzną regulacją, prosty rowek wiórowy, do wykonywania otworu przelotowego
HPR230

Wersja:

Średnica rozwiertaka:

7,000 - 18,590 mm

Nakrój:

MC1G

Materiał skrawający:

Węgiel spiekany z

powłoką PVD

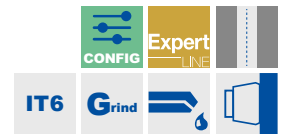
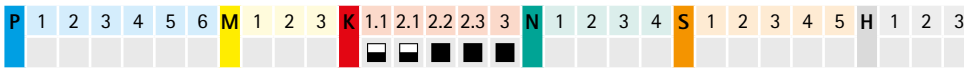
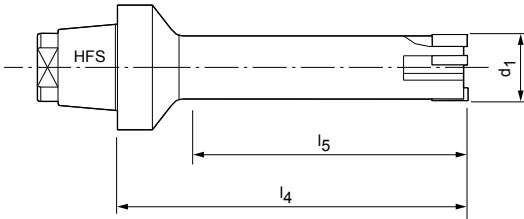

Możliwość konfiguracji parametrów

Tolerancja średnicy otworu IT6:

- Możliwość wyboru średnicy w krokach co 0,001 mm
- Dostępne w tolerancji IT6

Specyfikacja:

HPR230Ø[średnica][tolerancja]MC1G-HP423

Tolerancja średnicy otworu < IT6:

- Tolerancje mniejsze niż IT6 dostępne jako specjalna średnica narzędzia (wariant G – patrz strona 373)

Specyfikacja wariantu G:

HPR230GØ[średnica][tolerancja]MC1G-HP423

Wymiary typoszeregu z możliwością konfiguracji parametrów IT6

d_1	l_4	l_5	Wielkość HFS	z
7,000 - 9,590	60	45	12	4
9,600 - 18,590	60	45	12	6

Przykład tolerancji \geq IT6:

HPR230Ø10.350H6MC1G-HP423

 Średnica otworu $d_1 = 10,350 \text{ H6}$
Przykład wariantu G:

HPR230GØ10.350+1-1MC1G-HP423

 Średnica specjalna narzędzia $d_1 = 10,350 + 1 \mu\text{m} - 1 \mu\text{m}$

Wymiary podano w mm.

Odpowiednie uchwyty wymiennej głowicy HFS od strony 460.

Zalecane parametry skrawania – patrz koniec rozdziału.

Rozwiertak z wymienną głowicą HPR

Wersja z precyzyzną regulacją, prosty rowek wiórowy, do wykonywania otworu przelotowego
HPR230

Wersja:

Średnica rozwiertaka: 7,000 - 18,590 mm
Nakrój: MA0A
Materiał skrawający: PU620
Z ostrzami PCD

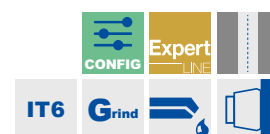
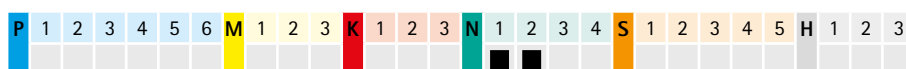
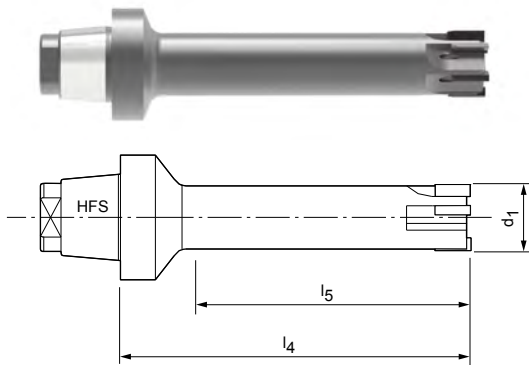

Możliwość konfiguracji parametrów



Tolerancja średnicy otworu IT6:

- Możliwość wyboru średnicy w krokach co 0,001 mm
- Dostępne w tolerancji IT6

Specyfikacja:

HPR230Ø[średnica][tolerancja]MA0A-PU620

Tolerancja średnicy otworu < IT6:

- Tolerancje mniejsze niż IT6 dostępne jako specjalna średnica narzędzia (wariant G – patrz strona 373)

Specyfikacja wariantu G:

HPR230GØ[średnica][tolerancja]MA0A-PU620

Wymiary typoszeregu z możliwością konfiguracji parametrów IT6

d ₁	l ₄	l ₅	Wielkość HFS	z
7,000 - 9,590	60	45	12	4
9,600 - 18,590	60	45	12	6

Przykład tolerancji ≥ IT6:

HPR230Ø10.350H6MA0A-PU620

Średnica otworu d₁ = 10,350 H6

Przykład wariantu G:

HPR230GØ10.350+1-1MA0A-PU620

Średnica specjalna narzędzia d₁ = 10,350 +1 μm -1 μm

Wymiary podano w mm.

Odpowiednie uchwyty wymiennej głowicy HFS od strony 460.

Zalecane parametry skrawania – patrz koniec rozdziału.

Rozwiertak z wymienną głowicą HPR

Wersja z precyzyzną regulacją, rowek lewoskrętny, do wykonywania otworu przelotowego HPR231

Wersja:

Średnica rozwiertaka:

7,000 - 18,590 mm

Nakrój:

ME1G

Materiał skrawający:

CU134

Cermet bez powłoki

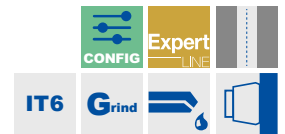
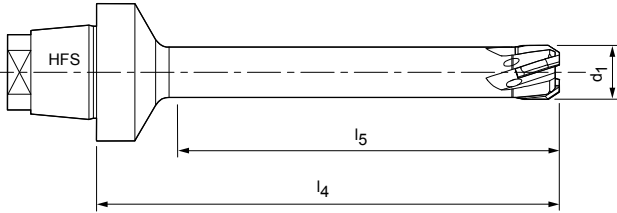

Możliwość konfiguracji parametrów

Tolerancja średnicy otworu IT6:

- Możliwość wyboru średnicy w krokach co 0,001 mm
- Dostępne w tolerancji IT6

Specyfikacja:

HPR231Ø[średnica][tolerancja]ME1G-CU134

Tolerancja średnicy otworu < IT6:

- Tolerancje mniejsze niż IT6 dostępne jako specjalna średnica narzędzia (wariant G – patrz strona 373)

Specyfikacja wariantu G:

HPR231GØ[średnica][tolerancja]ME1G-CU134

Wymiary typoszeregu z możliwością konfiguracji parametrów IT6

d_1	l_4	l_5	Wielkość HFS	z
7,000 - 9,590	60	45	12	4
9,600 - 18,590	60	45	12	6

Przykład tolerancji \geq IT6:

HPR231Ø10.350H6ME1G-CU134

 Średnica otworu $d_1 = 10,350 \text{ H6}$
Przykład wariantu G:

HPR231GØ10.350+1-1ME1G-CU134

 Średnica specjalna narzędzia $d_1 = 10,350 +1 \mu\text{m} -1 \mu\text{m}$

Wymiary podano w mm.

Odpowiednie uchwyty wymiennej głowicy HFS od strony 460.

Zalecane parametry skrawania – patrz koniec rozdziału.

Rozwiertak z wymienną głowicą HPR

Wersja z precyzyzną regulacją, rowek lewoskrętny, do wykonywania otworu przelotowego HPR231

Wersja:

Średnica rozwiertaka: 7,000 - 18,590 mm
 Nakrój: ME1G
 Materiał skrawający: HP421
 Węglik spiekany z powłoką PVD

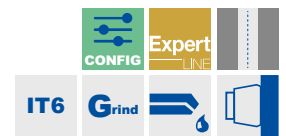
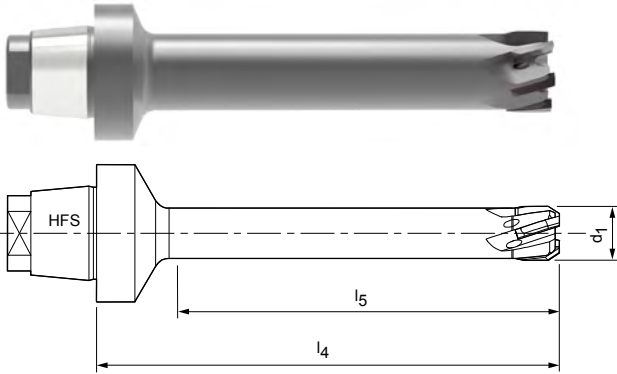

Możliwość konfiguracji parametrów



Tolerancja średnicy otworu IT6:

- Możliwość wyboru średnicy w krokach co 0,001 mm
- Dostępne w tolerancji IT6

Specyfikacja:

HPR231Ø[średnica][tolerancja]ME1G-HP421

Tolerancja średnicy otworu < IT6:

- Tolerancje mniejsze niż IT6 dostępne jako specjalna średnica narzędzia (wariant G – patrz strona 373)

Specyfikacja wariantu G:

HPR231GØ[średnica][tolerancja]ME1G-HP421

Wymiary typoszeregu z możliwością konfiguracji parametrów IT6

d ₁	l ₄	l ₅	Wielkość HFS	z
7,000 - 9,590	60	45	12	4
9,600 - 18,590	60	45	12	6

Przykład tolerancji ≥ IT6:

HPR231Ø10.350H6ME1G-HP421

Średnica otworu d₁ = 10,350 H6

Przykład wariantu G:

HPR231GØ10.350+1-1ME1G-HP421

Średnica specjalna narzędzia d₁ = 10,350 +1 μm -1 μm

Wymiary podano w mm.

Odpowiednie uchwyty wymiennej głowicy HFS od strony 460.

Zalecane parametry skrawania – patrz koniec rozdziału.

Rozwiertak z wymienną głowicą HPR

Wersja z precyzyjną regulacją, rowek lewoskrętny, do wykonywania otworu przelotowego HPR231

Wersja:

Średnica rozwiertaka:

7,000 - 18,590 mm

Nakrój:

MF1G

Materiał skrawający:

Węglik spiekany z powłoką PVD

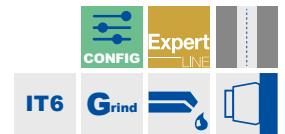
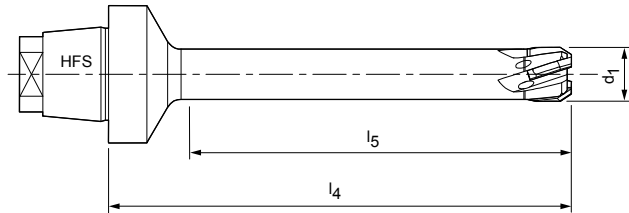

Możliwość konfiguracji parametrów

Tolerancja średnicy otworu IT6:

- Możliwość wyboru średnicy w krokach co 0,001 mm
- Dostępne w tolerancji IT6

Specyfikacja:

HPR231Ø[średnica][tolerancja]MF1G-HP421

Tolerancja średnicy otworu < IT6:

- Tolerancje mniejsze niż IT6 dostępne jako specjalna średnica narzędzia (wariant G – patrz strona 373)

Specyfikacja wariantu G:

HPR231GØ[średnica][tolerancja]MF1G-HP421

Wymiary typoszeregu z możliwością konfiguracji parametrów IT6

d_1	l_4	l_5	Wielkość HFS	z
7,000 - 9,590	60	45	12	4
9,600 - 18,590	60	45	12	6

Przykład tolerancji \geq IT6:

HPR231Ø10.350H6MF1G-HP421

 Średnica otworu $d_1 = 10,350 \text{ H6}$
Przykład wariantu G:

HPR231GØ10.350+1-1MF1G-HP421

 Średnica specjalna narzędzia $d_1 = 10,350 +1 \mu\text{m} -1 \mu\text{m}$

Wymiary podano w mm.

Odpowiednie uchwyty wymiennej głowicy HFS od strony 460.

Zalecane parametry skrawania – patrz koniec rozdziału.

Rozwiertak z wymienną głowicą HPR

Wersja z precyzyzną regulacją, rowek lewoskrętny, do wykonywania otworu przelotowego HPR231

Wersja:

Średnica rozwiertaka: 7,000 - 18,590 mm
 Nakrój: MF1G
 Materiał skrawający: HP625
 Węglik spiekany z powłoką PVD

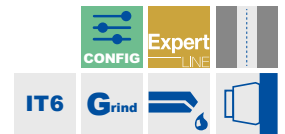
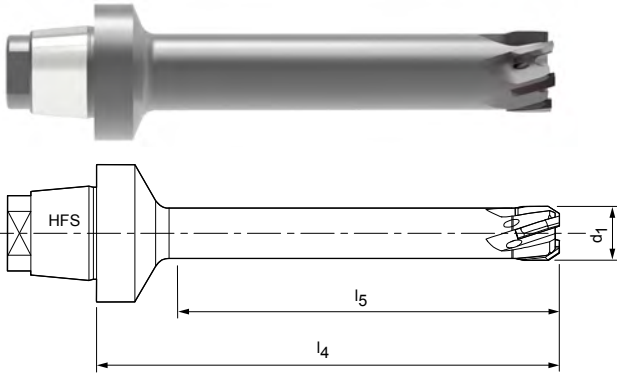

Możliwość konfiguracji parametrów



Tolerancja średnicy otworu IT6:

- Możliwość wyboru średnicy w krokach co 0,001 mm
- Dostępne w tolerancji IT6

Specyfikacja:

HPR231Ø[średnica][tolerancja]MF1G-HP625

Tolerancja średnicy otworu < IT6:

- Tolerancje mniejsze niż IT6 dostępne jako specjalna średnica narzędzia (wariant G – patrz strona 373)

Specyfikacja wariantu G:

HPR231GØ[średnica][tolerancja]MF1G-HP625

Wymiary typoszeregu z możliwością konfiguracji parametrów IT6

d ₁	l ₄	l ₅	Wielkość HFS	z
7,000 - 9,590	60	45	12	4
9,600 - 18,590	60	45	12	6

Przykład tolerancji ≥ IT6:

HPR231Ø10.350H6MF1G-HP625

Średnica otworu d₁ = 10,350 H6

Przykład wariantu G:

HPR231GØ10.350+1-1MF1G-HP625

Średnica specjalna narzędzia d₁ = 10,350 +1 μm -1 μm

Wymiary podano w mm.

Odpowiednie uchwyty wymiennej głowicy HFS od strony 460.

Zalecane parametry skrawania – patrz koniec rozdziału.

Rozwiertak z wymienną głowicą HPR

Wersja z precyzyzną regulacją, prosty rowek wiórowy, do wykonywania otworu przelotowego
HPR200

Wersja:

Średnica rozwiertaka:

18,600 – 65,000 mm

Nakrój:

MC1G

Materiał skrawający:

CP134

Cermet z powłoką PVD

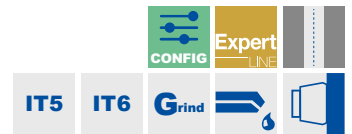
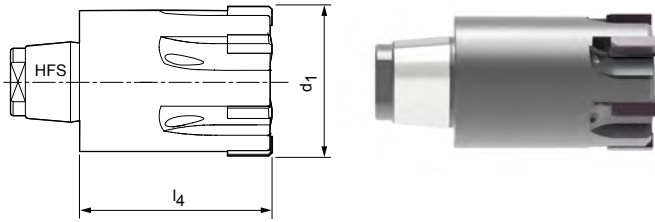

Możliwość konfiguracji parametrów

Tolerancja średnicy otworu IT5/IT6:

- Możliwość wyboru średnicy w krokach co 0,001 mm
- W zależności od zakresu średnicy, dostępne od tolerancji IT5/IT6
- > 030,000 IT5 | ≤ 030,000 IT6

Specyfikacja:

HPR200Ø[średnica][tolerancja]MC1G-CP134

Tolerancja średnicy otworu < IT5/IT6:

- Tolerancje mniejsze niż IT5/IT6 dostępne jako specjalna średnica narzędzia (wariant G – patrz strona 373)

Specyfikacja wariantu G:

HPR200GØ[średnica][tolerancja]MC1G-CP134

Wymiary typoszeregu z możliwością konfiguracji parametrów IT5/IT6

d_1	l_4	l_5	Wielkość HFS	z	Tolerancja
18,600 – 20,390	25	–	12	6	IT6
20,400 – 21,290	27	–	12	6	IT6
21,300 – 23,990	27	–	14	6	IT6
24,000 – 29,990	35	–	16	6	IT6
30,000 – 39,990	41	–	20	8	IT5
40,000 – 65,000	47	–	24	8	IT5

Przykład tolerancji IT5:

HPR200Ø35.350H5MC1G-CP134

 Średnica otworu $d_1 = 35,350 \text{ H5}$
Przykład wariantu G:

HPR200GØ35.350+1-1MC1G-CP134

 Średnica specjalna narzędzia $d_1 = 35,350 +1 \mu\text{m} -1 \mu\text{m}$

Wymiary podano w mm.

 * do powierzchni $R_a < 2 \mu\text{m}$

Odpowiednie uchwyty wymiennej głowicy HFS od strony 460.

Zalecane parametry skrawania – patrz koniec rozdziału.

Rozwiertak z wymienną głowicą HPR

Wersja z precyzyzną regulacją, prosty rowek wiórowy, do wykonywania otworu przelotowego
HPR200

Wersja:

Średnica rozwiertaka: 18,600 - 65,000 mm
Nakrój: MC1G
Materiał skrawający: HP421
Węglik spiekany z powłoką PVD

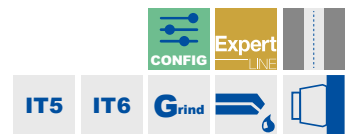
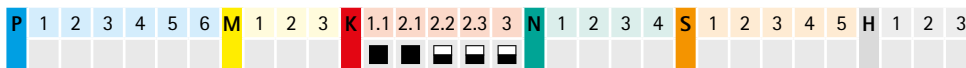
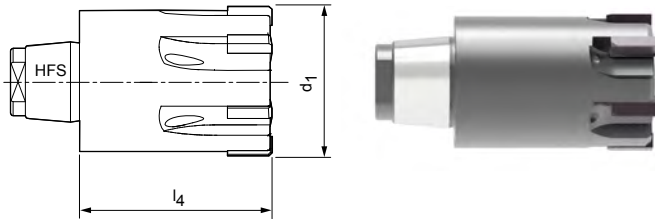

Możliwość konfiguracji parametrów



Tolerancja średnicy otworu IT5/IT6:

- Możliwość wyboru średnicy w krokach co 0,001 mm
- W zależności od zakresu średnicy, dostępne od tolerancji IT5/IT6
- > 030,000 IT5 | ≤ 030,000 IT6

Specyfikacja:

HPR200Ø[średnica][tolerancja]MC1G-HP421

Tolerancja średnicy otworu < IT5/IT6:

- Tolerancje mniejsze niż IT5/IT6 dostępne jako specjalna średnica narzędzia (wariant G – patrz strona 373)

Specyfikacja wariantu G:

HPR200GØ[średnica][tolerancja]MC1G-HP421

Wymiary typoszeregu z możliwością konfiguracji parametrów IT5/IT6

d ₁	l ₄	l ₅	Wielkość HFS	z	Tolerancja
18,600 - 20,390	25	-	12	6	IT6
20,400 - 21,290	27	-	12	6	IT6
21,300 - 23,990	27	-	14	6	IT6
24,000 - 29,990	35	-	16	6	IT6
30,000 - 39,990	41	-	20	8	IT5
40,000 - 65,000	47	-	24	8	IT5

Przykład tolerancji IT5:

HPR200Ø35.350H5MC1G-HP421

Średnica otworu d₁ = 35,350 H5

Przykład wariantu G:

HPR200GØ35.350+1-1MC1G-HP421

Średnica specjalna narzędzia d₁ = 35,350 +1 μm -1 μm

Wymiary podano w mm.

Odpowiednie uchwyty wymiennej głowicy HFS od strony 460.

Zalecane parametry skrawania – patrz koniec rozdziału.

Rozwiertak z wymienną głowicą HPR

Wersja z precyzyzną regulacją, prosty rowek wiórowy, do wykonywania otworu przelotowego
HPR200

Wersja:

Średnica rozwiertaka:

18,600 – 65,000 mm

Nakrój:

MC1G

Materiał skrawający:

Węgiel spiekany z

powłoką PVD

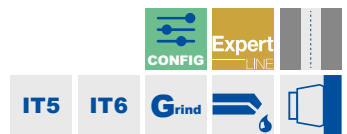
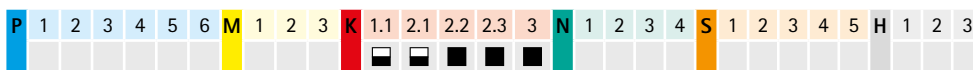
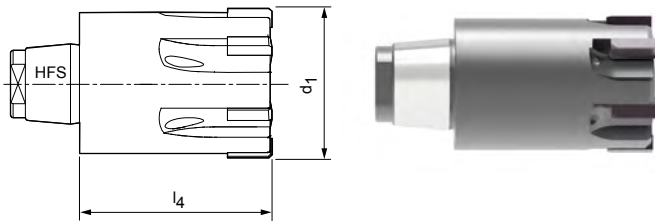

Możliwość konfiguracji parametrów



Tolerancja średnicy otworu IT5/IT6:

- Możliwość wyboru średnicy w krokach co 0,001 mm
- W zależności od zakresu średnicy, dostępne od tolerancji IT5/IT6
- > 030,000 IT5 | ≤ 030,000 IT6

Specyfikacja:

HPR200Ø[średnica][tolerancja]MC1G-HP423

Tolerancja średnicy otworu < IT5/IT6:

- Tolerancje mniejsze niż IT5/IT6 dostępne jako specjalna średnica narzędzia (wariant G – patrz strona 373)

Specyfikacja wariantu G:

HPR200GØ[średnica][tolerancja]MC1G-HP423

Wymiary typoszeregu z możliwością konfiguracji parametrów IT5/IT6

d_1	l_4	l_5	Wielkość HFS	z	Tolerancja
18,600 – 20,390	25	–	12	6	IT6
20,400 – 21,290	27	–	12	6	IT6
21,300 – 23,990	27	–	14	6	IT6
24,000 – 29,990	35	–	16	6	IT6
30,000 – 39,990	41	–	20	8	IT5
40,000 – 65,000	47	–	24	8	IT5

Przykład tolerancji IT5:

HPR200Ø35.350H5MC1G-HP423

Średnica otworu $d_1 = 35,350 \text{ H5}$

Przykład wariantu G:

HPR200GØ35.350+1-1MC1G-HP423

Średnica specjalna narzędzia $d_1 = 35,350 +1 \mu\text{m} -1 \mu\text{m}$

Wymiary podano w mm.

Odpowiednie uchwyty wymiennej głowicy HFS od strony 460.

Zalecane parametry skrawania – patrz koniec rozdziału.

Rozwiertak z wymienną głowicą HPR

Wersja z precyzyjną regulacją, prosty rowek wiórowy, do wykonywania otworu przelotowego
HPR200

Wersja:

Średnica rozwiertaka: 18,600 - 65,000 mm
Nakrój: MA0A
Materiał skrawający: PU620
Z ostrzami PCD

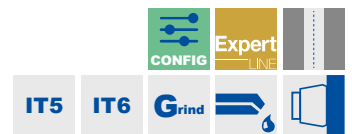
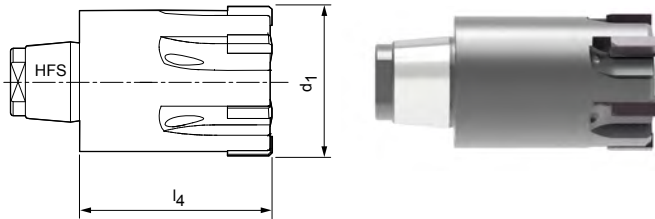

Możliwość konfiguracji parametrów



Tolerancja średnicy otworu IT5/IT6:

- Możliwość wyboru średnicy w krokach co 0,001 mm
- W zależności od zakresu średnicy, dostępne od tolerancji IT5/IT6
- > 030,000 IT5 | ≤ 030,000 IT6

Specyfikacja:

HPR200Ø[średnica][tolerancja]MA0A-PU620

Tolerancja średnicy otworu < IT5/IT6:

- Tolerancje mniejsze niż IT5/IT6 dostępne jako specjalna średnica narzędzia (wariant G – patrz strona 373)

Specyfikacja wariantu G:

HPR200GØ[średnica][tolerancja]MA0A-PU620

Wymiary typoszerogu z możliwością konfiguracji parametrów IT5/IT6

d ₁	l ₄	l ₅	Wielkość HFS	z	Tolerancja
18,600 - 20,390	25	-	12	6	IT6
20,400 - 21,290	27	-	12	6	IT6
21,300 - 23,990	27	-	14	6	IT6
24,000 - 29,990	35	-	16	6	IT6
30,000 - 39,990	41	-	20	8	IT5
40,000 - 65,000	47	-	24	8	IT5

Przykład tolerancji IT5:

HPR200Ø35.350H5MA0A-PU620

Średnica otworu d₁ = 35,350 H5

Przykład wariantu G:

HPR200GØ35.350+1-1MA0A-PU620

Średnica specjalna narzędzia d₁ = 35,350 +1 μm -1 μm

Wymiary podano w mm.

Odpowiednie uchwyty wymiennej głowicy HFS od strony 460.

Zalecane parametry skrawania – patrz koniec rozdziału.

Rozwiertak z wymienną głowicą HPR

Wersja z precyzyzną regulacją, rowek lewoskrętny, do wykonywania otworu przelotowego HPR210

Wersja:

Średnica rozwiertaka:

18,600 – 65,000 mm

Nakrój:

ME1G

Materiał skrawający:

CU134

Cermet bez powłoki

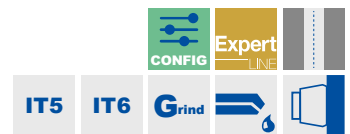
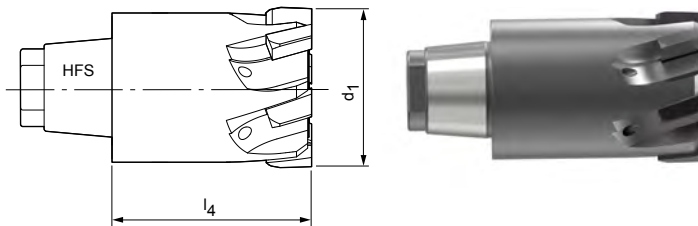

Możliwość konfiguracji parametrów

Tolerancja średnicy otworu IT5/IT6:

- Możliwość wyboru średnicy w krokach co 0,001 mm
- W zależności od zakresu średnicy, dostępne od tolerancji IT5/IT6
- > 030,000 IT5 | ≤ 030,000 IT6

Specyfikacja:

HPR210Ø[średnica][tolerancja]ME1G-CU134

Tolerancja średnicy otworu < IT5/IT6:

- Tolerancje mniejsze niż IT5/IT6 dostępne jako specjalna średnica narzędzia (wariant G – patrz strona 373)

Specyfikacja wariantu G:

HPR210GØ[średnica][tolerancja]ME1G-CU134

Wymiary typoszeregu z możliwością konfiguracji parametrów IT5/IT6

d_1	l_4	l_5	Wielkość HFS	z	Tolerancja
18,600 – 20,390	25	–	12	6	IT6
20,400 – 21,290	27	–	12	6	IT6
21,300 – 23,990	27	–	14	6	IT6
24,000 – 29,990	35	–	16	6	IT6
30,000 – 39,990	41	–	20	8	IT5
40,000 – 65,000	47	–	24	8	IT5

Przykład tolerancji IT5:

HPR210Ø35.350H5ME1G-CU134

 Średnica otworu $d_1 = 35,350 H5$
Przykład wariantu G:

HPR210GØ35.350+1-1ME1G-CU134

 Średnica specjalna narzędzia $d_1 = 35,350 +1 \mu\text{m} -1 \mu\text{m}$

Wymiary podano w mm.

Odpowiednie uchwyty wymiennej głowicy HFS od strony 460.

Zalecane parametry skrawania – patrz koniec rozdziału.

Rozwiertak z wymienną głowicą HPR

Wersja z precyzyzną regulacją, rowek lewoskrętny, do wykonywania otworu przelotowego HPR210

Wersja:

Średnica rozwiertaka: 18,600 - 65,000 mm
 Nakrój: ME1G
 Materiał skrawający: HP421
 Węglik spiekany z powłoką PVD

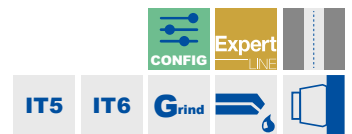
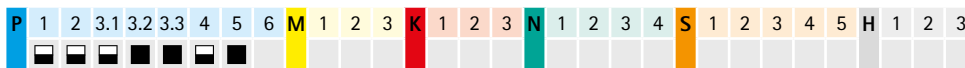
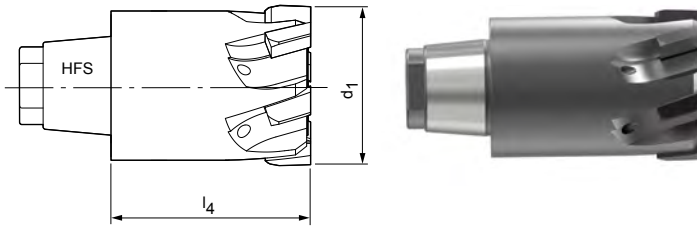

Możliwość konfiguracji parametrów



Tolerancja średnicy otworu IT5/IT6:

- Możliwość wyboru średnicy w krokach co 0,001 mm
- W zależności od zakresu średnicy, dostępne od tolerancji IT5/IT6
- > 030,000 IT5 | ≤ 030,000 IT6

Specyfikacja:

HPR210Ø[średnica][tolerancja]ME1G-HP421

Tolerancja średnicy otworu < IT5/IT6:

- Tolerancje mniejsze niż IT5/IT6 dostępne jako specjalna średnica narzędzia (wariant G – patrz strona 373)

Specyfikacja wariantu G:

HPR210GØ[średnica][tolerancja]ME1G-HP421

Wymiary typoszeregu z możliwością konfiguracji parametrów IT5/IT6

d ₁	l ₄	l ₅	Wielkość HFS	z	Tolerancja
18,600 - 20,390	25	-	12	6	IT6
20,400 - 21,290	27	-	12	6	IT6
21,300 - 23,990	27	-	14	6	IT6
24,000 - 29,990	35	-	16	6	IT6
30,000 - 39,990	41	-	20	8	IT5
40,000 - 65,000	47	-	24	8	IT5

Przykład tolerancji IT5:

HPR210Ø35.350H5ME1G-HP421

Średnica otworu d₁ = 35,350 H5

Przykład wariantu G:

HPR210GØ35.350+1-1ME1G-HP421

Średnica specjalna narzędzia d₁ = 35,350 +1 μm -1 μm

Wymiary podano w mm.

Odpowiednie uchwyty wymiennej głowicy HFS od strony 460.

Zalecane parametry skrawania – patrz koniec rozdziału.

Rozwiertak z wymienną głowicą HPR

Wersja z precyzyjną regulacją, rowek lewoskrętny, do wykonywania otworu przelotowego HPR210

Wersja:

Średnica rozwiertaka:

18,600 – 65,000 mm

Nakrój:

MF1G

Materiał skrawający:

Węgiel spiekany z powłoką PVD

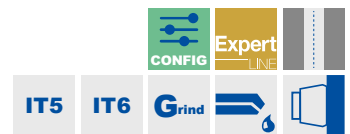
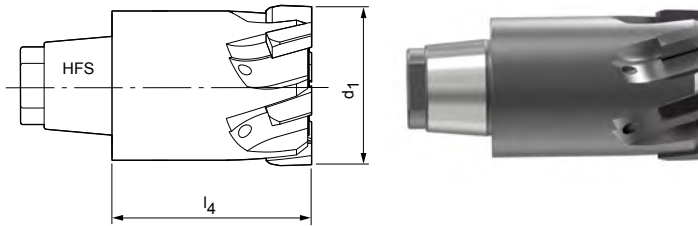

Możliwość konfiguracji parametrów

Tolerancja średnicy otworu IT5/IT6:

- Możliwość wyboru średnicy w krokach co 0,001 mm
- W zależności od zakresu średnicy, dostępne od tolerancji IT5/IT6
- > 030,000 IT5 | ≤ 030,000 IT6

Specyfikacja:

HPR210Ø[średnica][tolerancja]MF1G-HP421

Tolerancja średnicy otworu < IT5/IT6:

- Tolerancje mniejsze niż IT5/IT6 dostępne jako specjalna średnica narzędzia (wariant G – patrz strona 373)

Specyfikacja wariantu G:

HPR210GØ[średnica][tolerancja]MF1G-HP421

Wymiary typoszeregu z możliwością konfiguracji parametrów IT5/IT6

d_1	l_4	l_5	Wielkość HFS	z	Tolerancja
18,600 – 20,390	25	–	12	6	IT6
20,400 – 21,290	27	–	12	6	IT6
21,300 – 23,990	27	–	14	6	IT6
24,000 – 29,990	35	–	16	6	IT6
30,000 – 39,990	41	–	20	8	IT5
40,000 – 65,000	47	–	24	8	IT5

Przykład tolerancji IT5:

HPR210Ø35.350H5MF1G-HP421

 Średnica otworu $d_1 = 35,350 \text{ H5}$
Przykład wariantu G:

HPR210GØ35.350+1-1MF1G-HP421

 Średnica specjalna narzędzia $d_1 = 35,350 +1 \mu\text{m} -1 \mu\text{m}$

Wymiary podano w mm.

Odpowiednie uchwyty wymiennej głowicy HFS od strony 460.

Zalecane parametry skrawania – patrz koniec rozdziału.

Rozwiertak z wymienną głowicą HPR

Wersja z precyzyzną regulacją, rowek lewoskrętny, do wykonywania otworu przelotowego HPR210

Wersja:

Średnica rozwiertaka: 18,600 – 65,000 mm
 Nakrój: MF1G
 Materiał skrawający: HP625
 Węglik spiekany z powłoką PVD

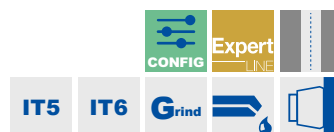
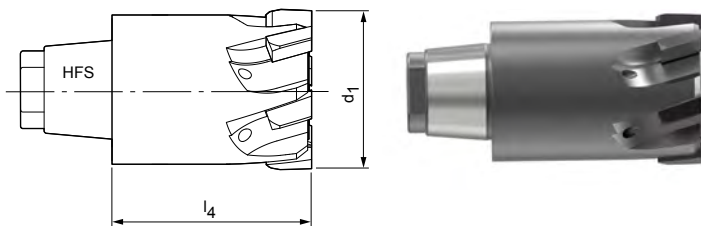

Możliwość konfiguracji parametrów



Tolerancja średnicy otworu IT5/IT6:

- Możliwość wyboru średnicy w krokach co 0,001 mm
- W zależności od zakresu średnicy, dostępne od tolerancji IT5/IT6
- > 030,000 IT5 | ≤ 030,000 IT6

Specyfikacja:

HPR210Ø[średnica][tolerancja]MF1G-HP625

Tolerancja średnicy otworu < IT5/IT6:

- Tolerancje mniejsze niż IT5/IT6 dostępne jako specjalna średnica narzędzia (wariant G – patrz strona 373)

Specyfikacja wariantu G:

HPR210GØ[średnica][tolerancja]MF1G-HP625

Wymiary typoszerogu z możliwością konfiguracji parametrów IT5/IT6

d ₁	l ₄	l ₅	Wielkość HFS	z	Tolerancja
18,600 – 20,390	25	–	12	6	IT6
20,400 – 21,290	27	–	12	6	IT6
21,300 – 23,990	27	–	14	6	IT6
24,000 – 29,990	35	–	16	6	IT6
30,000 – 39,990	41	–	20	8	IT5
40,000 – 65,000	47	–	24	8	IT5

Przykład tolerancji IT5:

HPR210Ø35.350H5MF1G-HP625

Średnica otworu d₁ = 35,350 H5

Przykład wariantu G:

HPR210GØ35.350+1-1MF1G-HP625

Średnica specjalna narzędzia d₁ = 35,350 +1 μm -1 μm

Wymiary podano w mm.

Odpowiednie uchwyty wymiennej głowicy HFS od strony 460.

Zalecane parametry skrawania – patrz koniec rozdziału.

Rozwiertak z wymienną głowicą HPR

Wersja z precyzyzną regulacją, prosty rowek wiórowy, do obróbki otworu nieprzelotowego HPR280

Wersja:

Średnica rozwiertaka:

7,000 - 21,290 mm

Nakrój:

ML2G

Materiał skrawający:

CU134

Cermet bez powłoki

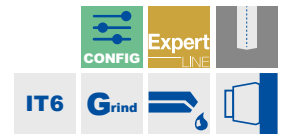
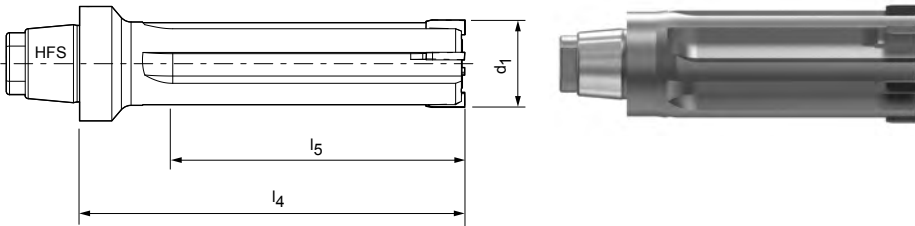

Możliwość konfiguracji parametrów

Tolerancja średnicy otworu IT6:

- Możliwość wyboru średnicy w krokach co 0,001 mm
- Dostępne w tolerancji IT6

Specyfikacja:

HPR280Ø[średnica][tolerancja]ML2G-CU134

Tolerancja średnicy otworu < IT6:

- Tolerancje mniejsze niż IT6 dostępne jako specjalna średnica narzędzia (wariant G – patrz strona 373)

Specyfikacja wariantu G:

HPR280GØ[średnica][tolerancja]ML2G-CU134

Wymiary typoszeregu z możliwością konfiguracji parametrów IT6

d_1	l_4	l_5	Wielkość HFS	z
7,000 - 14,590	60	40	12	4
14,600 - 21,290	60	40	12	6

Przykład tolerancji \geq IT6:

HPR280Ø16.350H6ML2G-CU134

 Średnica otworu $d_1 = 16,350 \text{ H6}$
Przykład wariantu G:

HPR280GØ16.350+1-1ML2G-CU134

 Średnica specjalna narzędzia $d_1 = 16,350 + 1 \mu\text{m} - 1 \mu\text{m}$

Wymiary podano w mm.

Odpowiednie uchwyty wymiennej głowicy HFS od strony 460.

Zalecane parametry skrawania – patrz koniec rozdziału.

Rozwiertak z wymienną głowicą HPR

Wersja z precyzyzną regulacją, prosty rowek wiórowy, do obróbki otworu nieprzelotowego HPR280

Wersja:

Średnica rozwiertaka: 7,000 - 21,290 mm
 Nakrój: ML2G
 Materiał skrawający: HP421
 Węglik spiekany z powłoką PVD

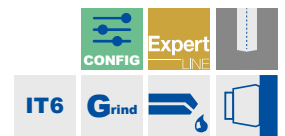
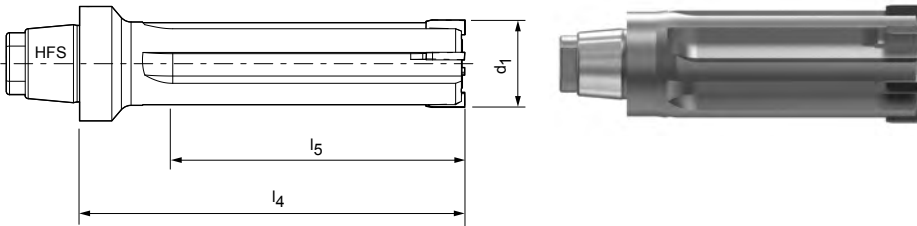

Możliwość konfiguracji parametrów



Tolerancja średnicy otworu IT6:

- Możliwość wyboru średnicy w krokach co 0,001 mm
- Dostępne w tolerancji IT6

Specyfikacja:

HPR280Ø[średnica][tolerancja]ML2G-HP421

Tolerancja średnicy otworu < IT6:

- Tolerancje mniejsze niż IT6 dostępne jako specjalna średnica narzędzia (wariant G – patrz strona 373)

Specyfikacja wariantu G:

HPR280GØ[średnica][tolerancja]ML2G-HP421

Wymiary typoszeregu z możliwością konfiguracji parametrów IT6

d ₁	l ₄	l ₅	Wielkość HFS	z
7,000 - 14,590	60	40	12	4
14,600 - 21,290	60	40	12	6

Przykład tolerancji ≥ IT6:

HPR280Ø16.350H6ML2G-HP421

Średnica otworu d₁ = 16,350 H6

Przykład wariantu G:

HPR280GØ16.350+1-1ML2G-HP421

Średnica specjalna narzędzia d₁ = 16,350 +1 μm -1 μm

Wymiary podano w mm.

Odpowiednie uchwyty wymiennej głowicy HFS od strony 460.

Zalecane parametry skrawania – patrz koniec rozdziału.

Rozwiertak z wymienną głowicą HPR

Wersja z precyzyzną regulacją, prosty rowek wiórowy, do obróbki otworu nieprzelotowego HPR280

Wersja:

Średnica rozwiertaka:

7,000 - 21,290 mm

Nakrój:

M02G

Materiał skrawający:

Węgiel spiekany z powłoką PVD

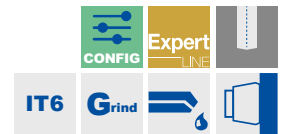
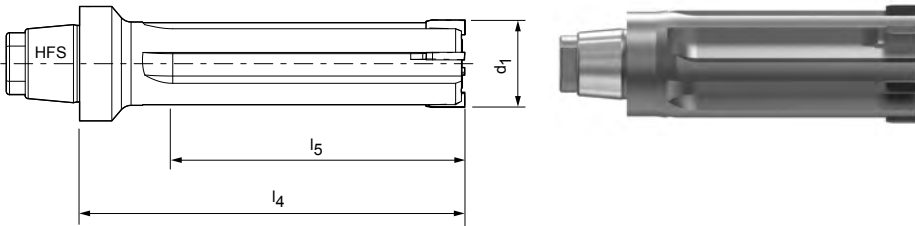

Możliwość konfiguracji parametrów

Tolerancja średnicy otworu IT6:

- Możliwość wyboru średnicy w krokach co 0,001 mm
- Dostępne w tolerancji IT6

Specyfikacja:

HPR280Ø[średnica][tolerancja]M02G-HP421

Tolerancja średnicy otworu < IT6:

- Tolerancje mniejsze niż IT6 dostępne jako specjalna średnica narzędzia (wariant G – patrz strona 373)

Specyfikacja wariantu G:

HPR280GØ[średnica][tolerancja]M02G-HP421

Wymiary typoszeregu z możliwością konfiguracji parametrów IT6

d_1	l_4	l_5	Wielkość HFS	z
7,000 - 14,590	60	40	12	4
14,600 - 21,290	60	40	12	6

Przykład tolerancji \geq IT6:

HPR280Ø16.350H6M02G-HP421

 Średnica otworu $d_1 = 16,350 \text{ H6}$
Przykład wariantu G:

HPR280GØ16.350+1-1M02G-HP421

 Średnica specjalna narzędzia $d_1 = 16,350 + 1 \mu\text{m} - 1 \mu\text{m}$

Wymiary podano w mm.

Odpowiednie uchwyty wymiennej głowicy HFS od strony 460.

Zalecane parametry skrawania – patrz koniec rozdziału.

Rozwiertak z wymienną głowicą HPR

Wersja z precyzyzną regulacją, prosty rowek wiórowy, do obróbki otworu nieprzelotowego HPR280

Wersja:

Średnica rozwiertaka:

7,000 - 21,290 mm

Nakrój:

MC1G

Materiał skrawający:

CP134

Cermet z powłoką PVD

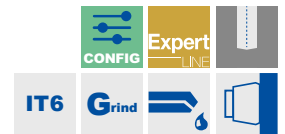
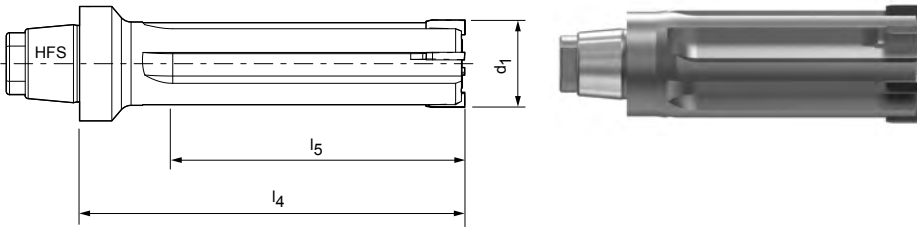

Możliwość konfiguracji parametrów



Tolerancja średnicy otworu IT6:

- Możliwość wyboru średnicy w krokach co 0,001 mm
- Dostępne w tolerancji IT6

Specyfikacja:

HPR280Ø[średnica][tolerancja]MC1G-CP134

Tolerancja średnicy otworu < IT6:

- Tolerancje mniejsze niż IT6 dostępne jako specjalna średnica narzędzia (wariant G – patrz strona 373)

Specyfikacja wariantu G:

HPR280GØ[średnica][tolerancja]MC1G-CP134

Wymiary typoszeregu z możliwością konfiguracji parametrów IT6

d ₁	l ₄	l ₅	Wielkość HFS	z
7,000 - 14,590	60	40	12	4
14,600 - 21,290	60	40	12	6

Przykład tolerancji ≥ IT6:

HPR280Ø16.350H6MC1G-CP134

Średnica otworu d₁ = 16,350 H6

Przykład wariantu G:

HPR280GØ16.350+1-1MC1G-CP134

Średnica specjalna narzędzia d₁ = 16,350 +1 μm -1 μm

Wymiary podano w mm.

* do powierzchni R_a < 2 μm

Odpowiednie uchwyty wymiennej głowicy HFS od strony 460.

Zalecane parametry skrawania – patrz koniec rozdziału.

Rozwiertak z wymienną głowicą HPR

Wersja z precyzyzną regulacją, prosty rowek wiórowy, do obróbki otworu nieprzelotowego HPR280

Wersja:

Średnica rozwiertaka:

7,000 - 21,290 mm

Nakrój:

MC1G

Materiał skrawający:

HP421

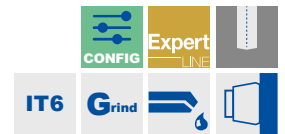
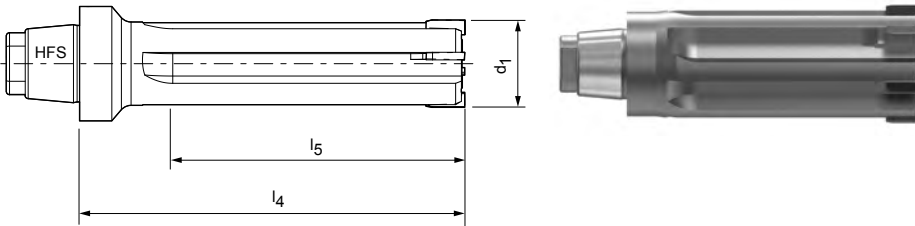
 Węgiel spiekany z
powłoką PVD

Możliwość konfiguracji parametrów

Tolerancja średnicy otworu IT6:

- Możliwość wyboru średnicy w krokach co 0,001 mm
- Dostępne w tolerancji IT6

Specyfikacja:

HPR280Ø[średnica][tolerancja]MC1G-HP421

Tolerancja średnicy otworu < IT6:

- Tolerancje mniejsze niż IT6 dostępne jako specjalna średnica narzędzia (wariant G – patrz strona 373)

Specyfikacja wariantu G:

HPR280GØ[średnica][tolerancja]MC1G-HP421

Wymiary typoszeregu z możliwością konfiguracji parametrów IT6

d_1	l_4	l_5	Wielkość HFS	z
7,000 - 14,590	60	40	12	4
14,600 - 21,290	60	40	12	6

Przykład tolerancji \geq IT6:

HPR280Ø16.350H6MC1G-HP421

 Średnica otworu $d_1 = 16,350 \text{ H6}$
Przykład wariantu G:

HPR280GØ16.350+1-1MC1G-HP421

 Średnica specjalna narzędzia $d_1 = 16,350 + 1 \mu\text{m} - 1 \mu\text{m}$

Wymiary podano w mm.

Odpowiednie uchwyty wymiennej głowicy HFS od strony 460.

Zalecane parametry skrawania – patrz koniec rozdziału.

Rozwiertak z wymienną głowicą HPR

Wersja z precyzyzną regulacją, prosty rowek wiórowy, do obróbki otworu nieprzelotowego HPR280

Wersja:

Średnica rozwiertaka:

7,000 - 21,290 mm

Nakrój:

MC1G

Materiał skrawający:

Węgiel spiekany z

powłoką PVD

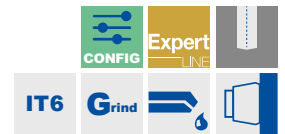
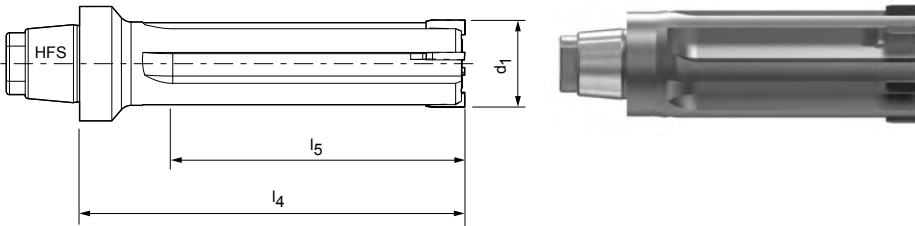

Możliwość konfiguracji parametrów



Tolerancja średnicy otworu IT6:

- Możliwość wyboru średnicy w krokach co 0,001 mm
- Dostępne w tolerancji IT6

Specyfikacja:

HPR280Ø[średnica][tolerancja]MC1G-HP423

Tolerancja średnicy otworu < IT6:

- Tolerancje mniejsze niż IT6 dostępne jako specjalna średnica narzędzia (wariant G – patrz strona 373)

Specyfikacja wariantu G:

HPR280GØ[średnica][tolerancja]MC1G-HP423

Wymiary typoszeregu z możliwością konfiguracji parametrów IT6

d ₁	l ₄	l ₅	Wielkość HFS	z
7,000 - 14,590	60	40	12	4
14,600 - 21,290	60	40	12	6

Przykład tolerancji ≥ IT6:

HPR280Ø16.350H6MC1G-HP423

Średnica otworu d₁ = 16,350 H6

Przykład wariantu G:

HPR280GØ16.350+1-1MC1G-HP423

Średnica specjalna narzędzia d₁ = 16,350 +1 μm -1 μm

Wymiary podano w mm.

Odpowiednie uchwyty wymiennej głowicy HFS od strony 460.

Zalecane parametry skrawania – patrz koniec rozdziału.

Rozwiertak z wymienną głowicą HPR

Wersja z precyzyzną regulacją, prosty rowek wiórowy, do obróbki otworu nieprzelotowego HPR280

Wersja:

Średnica rozwiertaka:

7,000 - 21,290 mm

Nakrój:

MA0A

Materiał skrawający:

PU620

Z ostrzami PCD

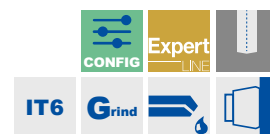
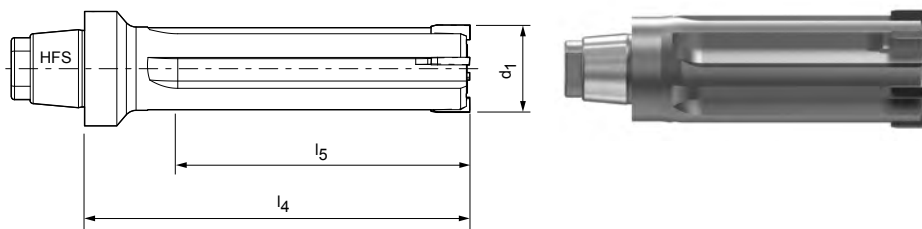

Możliwość konfiguracji parametrów

Tolerancja średnicy otworu IT6:

- Możliwość wyboru średnicy w krokach co 0,001 mm
- Dostępne w tolerancji IT6

Specyfikacja:

HPR280Ø[średnica][tolerancja]MA0A-PU620

Tolerancja średnicy otworu < IT6:

- Tolerancje mniejsze niż IT6 dostępne jako specjalna średnica narzędzia (wariant G – patrz strona 373)

Specyfikacja wariantu G:

HPR280GØ[średnica][tolerancja]MA0A-PU620

Wymiary typoszeregu z możliwością konfiguracji parametrów IT6

d_1	l_4	l_5	Wielkość HFS	z
7,000 - 14,590	60	40	12	4
14,600 - 21,290	60	40	12	6

Przykład tolerancji \geq IT6:

HPR280Ø16.350H6MA0A-PU620

 Średnica otworu $d_1 = 16,350 \text{ H6}$
Przykład wariantu G:

HPR280GØ16.350+1-1MA0A-PU620

 Średnica specjalna narzędzia $d_1 = 16,350 + 1 \mu\text{m} - 1 \mu\text{m}$

Wymiary podano w mm.

Odpowiednie uchwyty wymiennej głowicy HFS od strony 460.

Zalecane parametry skrawania – patrz koniec rozdziału.

Rozwiertak z wymienną głowicą HPR

Wersja z precyzyzną regulacją, prosty rowek wiórowy, do obróbki otworu nieprzelotowego HPR280

Wersja:

Średnica rozwiertaka: 7,000 - 21,290 mm
 Nakrój: M02G
 Materiał skrawający: HP625
 Węglik spiekany z powłoką PVD

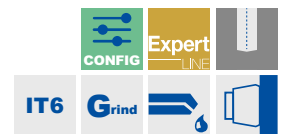
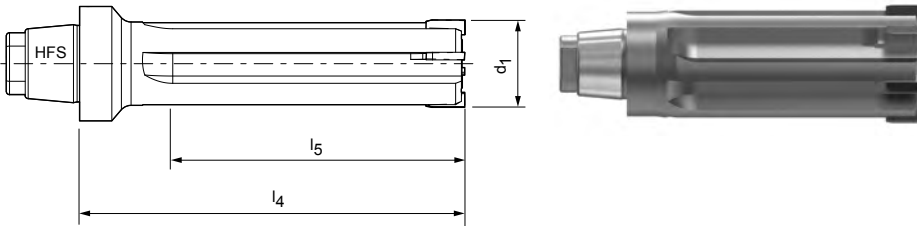

Możliwość konfiguracji parametrów



Tolerancja średnicy otworu IT6:

- Możliwość wyboru średnicy w krokach co 0,001 mm
- Dostępne w tolerancji IT6

Specyfikacja:

HPR280Ø[średnica][tolerancja]M02G-HP625

Tolerancja średnicy otworu < IT6:

- Tolerancje mniejsze niż IT6 dostępne jako specjalna średnica narzędzia (wariant G – patrz strona 373)

Specyfikacja wariantu G:

HPR280GØ[średnica][tolerancja]M02G-HP625

Wymiary typoszeregu z możliwością konfiguracji parametrów IT6

d ₁	l ₄	l ₅	Wielkość HFS	z
7,000 - 14,590	60	40	12	4
14,600 - 21,290	60	40	12	6

Przykład tolerancji ≥ IT6:

HPR280Ø16.350H6M02G-HP625

Średnica otworu d₁ = 16,350 H6

Przykład wariantu G:

HPR280GØ16.350+1-1M02G-HP625

Średnica specjalna narzędzia d₁ = 16,350 +1 μm -1 μm

Wymiary podano w mm.

Odpowiednie uchwyty wymiennej głowicy HFS od strony 460.

Zalecane parametry skrawania – patrz koniec rozdziału.

Rozwiertak z wymienną głowicą HPR

Wersja z precyzyzną regulacją, prosty rowek wiórowy, do obróbki otworu nieprzelotowego HPR250

Wersja:

Średnica rozwiertaka:

16,600 – 65,000 mm

Nakrój:

ML2G

Materiał skrawający:

CU134

Cermet bez powłoki

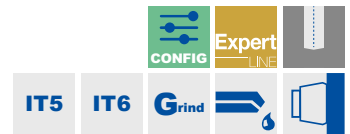
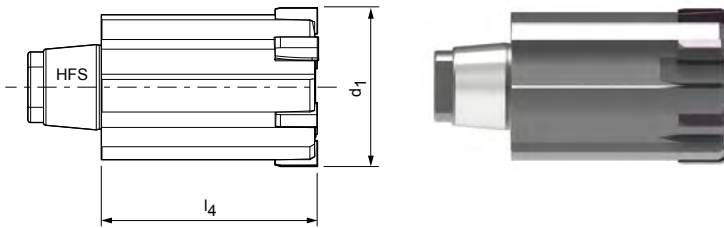

Możliwość konfiguracji parametrów



Tolerancja średnicy otworu IT5/IT6:

- Możliwość wyboru średnicy w krokach co 0,001 mm
- W zależności od zakresu średnicy, dostępne od tolerancji IT5/IT6
- > 030,000 IT5 | ≤ 030,000 IT6

Specyfikacja:

HPR250Ø[średnica][tolerancja]ML2G-CU134

Tolerancja średnicy otworu < IT5/IT6:

- Tolerancje mniejsze niż IT5/IT6 dostępne jako specjalna średnica narzędzia (wariant G – patrz strona 373)

Specyfikacja wariantu G:

HPR250GØ[średnica][tolerancja]ML2G-CU134

Wymiary typoszeregu z możliwością konfiguracji parametrów IT5/IT6

d_1	l_4	l_5	Wielkość HFS	z	Tolerancja
16,600 – 21,290	25	–	10	6	IT6
21,300 – 24,990	27	–	12	6	IT6
25,000 – 28,590	35	–	14	6	IT6
29,000 – 32,290	35	–	16	6	IT5
32,300 – 36,990	41	–	16	6	IT5
37,000 – 41,190	41	–	20	8	IT5
41,200 – 44,900	47	–	20	8	IT5
45,000 – 65,000	47	–	24	8	IT5

Przykład tolerancji IT5:

HPR250Ø35.350H5ML2G-CU134

 Średnica otworu $d_1 = 35,350$ H5

Przykład wariantu G:

HPR250GØ35.350+1-1ML2G-CU134

 Średnica specjalna narzędzia $d_1 = 35,350 + 1 \mu\text{m} - 1 \mu\text{m}$

Wymiary podano w mm.

Odpowiednie uchwyty wymiennej głowicy HFS od strony 460.

Zalecane parametry skrawania – patrz koniec rozdziału.

Rozwiertak z wymienną głowicą HPR

Wersja z precyzyzną regulacją, prosty rowek wiórowy, do obróbki otworu nieprzelotowego HPR250

Wersja:

Średnica rozwiertaka: 16,600 – 65,000 mm
 Nakrój: ML2G
 Materiał skrawający: HP421
 Węglik spiekany z powłoką PVD

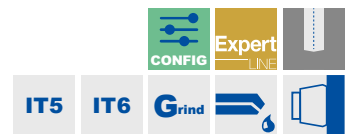
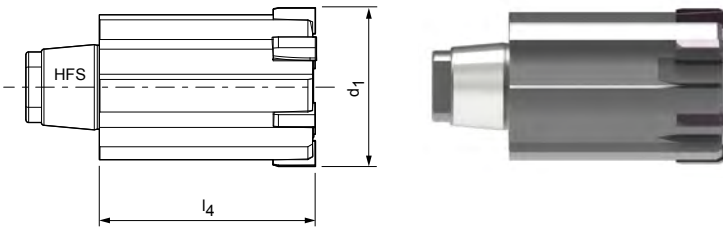

Możliwość konfiguracji parametrów



Tolerancja średnicy otworu IT5/IT6:

- Możliwość wyboru średnicy w krokach co 0,001 mm
- W zależności od zakresu średnicy, dostępne od tolerancji IT5/IT6
- > 030,000 IT5 | ≤ 030,000 IT6

Specyfikacja:

HPR250Ø[średnica][tolerancja]ML2G-HP421

Tolerancja średnicy otworu < IT5/IT6:

- Tolerancje mniejsze niż IT5/IT6 dostępne jako specjalna średnica narzędzia (wariant G – patrz strona 373)

Specyfikacja wariantu G:

HPR250GØ[średnica][tolerancja]ML2G-HP421

Wymiary typoszeregu z możliwością konfiguracji parametrów IT5/IT6

d ₁	l ₄	l ₅	Wielkość HFS	z	Tolerancja
16,600 – 21,290	25	–	10	6	IT6
21,300 – 24,990	27	–	12	6	IT6
25,000 – 28,590	35	–	14	6	IT6
29,000 – 32,290	35	–	16	6	IT5
32,300 – 36,990	41	–	16	6	IT5
37,000 – 41,190	41	–	20	8	IT5
41,200 – 44,900	47	–	20	8	IT5
45,000 – 65,000	47	–	24	8	IT5

Przykład tolerancji IT5:

HPR250Ø35.350H5ML2G-HP421

Średnica otworu d₁ = 35,350 H5

Przykład wariantu G:

HPR250GØ35.350+1-1ML2G-HP421

Średnica specjalna narzędzia d₁ = 35,350 +1 μm -1 μm

Wymiary podano w mm.

Odpowiednie uchwyty wymiennej głowicy HFS od strony 460.

Zalecane parametry skrawania – patrz koniec rozdziału.

Rozwiertak z wymienną głowicą HPR

Wersja z precyzyzną regulacją, prosty rowek wiórowy, do obróbki otworu nieprzelotowego HPR250

Wersja:

Średnica rozwiertaka:

16,600 – 65,000 mm

Nakrój:

M02G

Materiał skrawający:

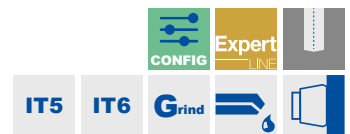
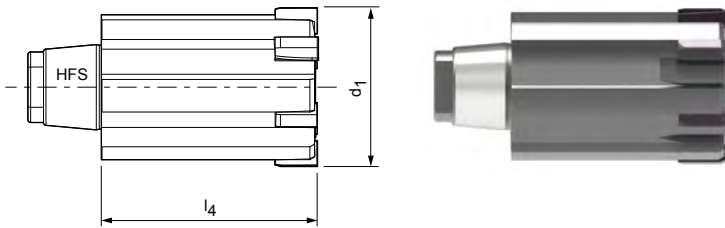
 HP421
 Węglik spiekany z
 powłoką PVD

Możliwość konfiguracji parametrów

Tolerancja średnicy otworu IT5/IT6:

- Możliwość wyboru średnicy w krokach co 0,001 mm
- W zależności od zakresu średnicy, dostępne od tolerancji IT5/IT6
- > 030,000 IT5 | ≤ 030,000 IT6

Specyfikacja:

HPR250Ø[średnica][tolerancja]M02G-HP421

Tolerancja średnicy otworu < IT5/IT6:

- Tolerancje mniejsze niż IT5/IT6 dostępne jako specjalna średnica narzędzia (wariant G – patrz strona 373)

Specyfikacja wariantu G:

HPR250GØ[średnica][tolerancja]M02G-HP421

Wymiary typoszeregu z możliwością konfiguracji parametrów IT5/IT6

d_1	l_4	l_5	Wielkość HFS	z	Tolerancja
16,600 – 21,290	25	–	10	6	IT6
21,300 – 24,990	27	–	12	6	IT6
25,000 – 28,590	35	–	14	6	IT6
29,000 – 32,290	35	–	16	6	IT5
32,300 – 36,990	41	–	16	6	IT5
37,000 – 41,190	41	–	20	8	IT5
41,200 – 44,900	47	–	20	8	IT5
45,000 – 65,000	47	–	24	8	IT5

Przykład tolerancji IT5:

HPR250Ø35.350H5M02G-HP421

 Średnica otworu $d_1 = 35,350 \text{ H5}$
Przykład wariantu G:

HPR250GØ35.350+1-1M02G-HP421

 Średnica specjalna narzędzia $d_1 = 35,350 + 1 \mu\text{m} - 1 \mu\text{m}$

Wymiary podano w mm.

Odpowiednie uchwyty wymiennej głowicy HFS od strony 460.

Zalecane parametry skrawania – patrz koniec rozdziału.

Rozwiertak z wymienną głowicą HPR

Wersja z precyzyzną regulacją, prosty rowek wiórowy, do obróbki otworu nieprzelotowego HPR250

Wersja:

Średnica rozwiertaka:

16,600 – 65,000 mm

Nakrój:

MC1G

Materiał skrawający:

CP134

Cermet z powłoką PVD

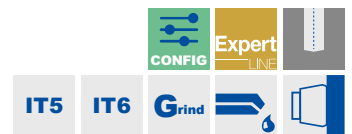
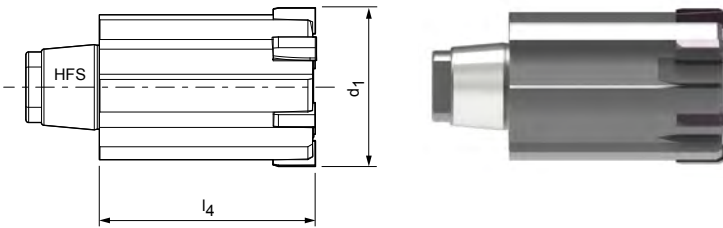

Możliwość konfiguracji parametrów



Tolerancja średnicy otworu IT5/IT6:

- Możliwość wyboru średnicy w krokach co 0,001 mm
- W zależności od zakresu średnicy, dostępne od tolerancji IT5/IT6
- > 030,000 IT5 | ≤ 030,000 IT6

Specyfikacja:

HPR250Ø[średnica][tolerancja]MC1G-CP134

Tolerancja średnicy otworu < IT5/IT6:

- Tolerancje mniejsze niż IT5/IT6 dostępne jako specjalna średnica narzędzia (wariant G – patrz strona 373)

Specyfikacja wariantu G:

HPR250GØ[średnica][tolerancja]MC1G-CP134

Wymiary typoszeregu z możliwością konfiguracji parametrów IT5/IT6

d ₁	l ₄	l ₅	Wielkość HFS	z	Tolerancja
16,600 – 21,290	25	–	10	6	IT6
21,300 – 24,990	27	–	12	6	IT6
25,000 – 28,590	35	–	14	6	IT6
29,000 – 32,290	35	–	16	6	IT5
32,300 – 36,990	41	–	16	6	IT5
37,000 – 41,190	41	–	20	8	IT5
41,200 – 44,900	47	–	20	8	IT5
45,000 – 65,000	47	–	24	8	IT5

Przykład tolerancji IT5:

HPR250Ø35.350H5MC1G-CP134

Średnica otworu d₁ = 35,350 H5

Przykład wariantu G:

HPR250GØ35.350+1-1MC1G-CP134

Średnica specjalna narzędzia d₁ = 35,350 +1 μm -1 μm

Wymiary podano w mm.

* do powierzchni R_a < 2 μm

Odpowiednie uchwyty wymiennej głowicy HFS od strony 460.

Zalecane parametry skrawania – patrz koniec rozdziału.

Rozwiertak z wymienną głowicą HPR

Wersja z precyzyjną regulacją, prosty rowek wiórowy, do obróbki otworu nieprzelotowego HPR250

Wersja:

Średnica rozwiertaka:

16,600 – 65,000 mm

Nakrój:

MC1G

Materiał skrawający:

HP421

Węglik spiekany z powłoką PVD

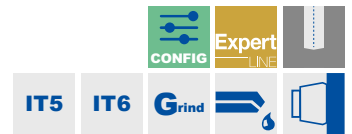
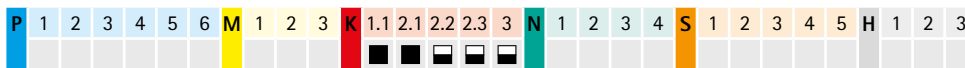
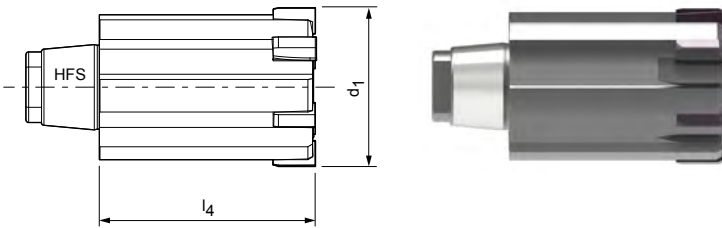

Możliwość konfiguracji parametrów

Tolerancja średnicy otworu IT5/IT6:

- Możliwość wyboru średnicy w krokach co 0,001 mm
- W zależności od zakresu średnicy, dostępne od tolerancji IT5/IT6
- > 030,000 IT5 | ≤ 030,000 IT6

Specyfikacja:

HPR250Ø[średnica][tolerancja]MC1G-HP421

Tolerancja średnicy otworu < IT5/IT6:

- Tolerancje mniejsze niż IT5/IT6 dostępne jako specjalna średnica narzędzia (wariant G – patrz strona 373)

Specyfikacja wariantu G:

HPR250GØ[średnica][tolerancja]MC1G-HP421

Wymiary typoszeregu z możliwością konfiguracji parametrów IT5/IT6

d_1	l_4	l_5	Wielkość HFS	z	Tolerancja
16,600 – 21,290	25	–	10	6	IT6
21,300 – 24,990	27	–	12	6	IT6
25,000 – 28,590	35	–	14	6	IT6
29,000 – 32,290	35	–	16	6	IT5
32,300 – 36,990	41	–	16	6	IT5
37,000 – 41,190	41	–	20	8	IT5
41,200 – 44,900	47	–	20	8	IT5
45,000 – 65,000	47	–	24	8	IT5

Przykład tolerancji IT5:

HPR250Ø35.350H5MC1G-HP421

 Średnica otworu $d_1 = 35,350 H5$
Przykład wariantu G:

HPR250GØ35.350+1-1MC1G-HP421

 Średnica specjalna narzędzia $d_1 = 35,350 +1 \mu\text{m} -1 \mu\text{m}$

Wymiary podano w mm.

Odpowiednie uchwyty wymiennej głowicy HFS od strony 460.

Zalecane parametry skrawania – patrz koniec rozdziału.

Rozwiertak z wymienną głowicą HPR

Wersja z precyzyzną regulacją, prosty rowek wiórowy, do obróbki otworu nieprzelotowego HPR250

Wersja:

Średnica rozwiertaka: 16,600 – 65,000 mm
 Nakrój: MC1G
 Materiał skrawający: HP423
 Węglik spiekany z powłoką PVD

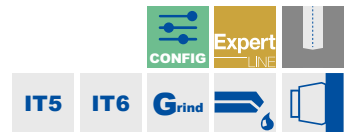
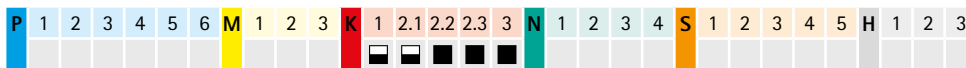
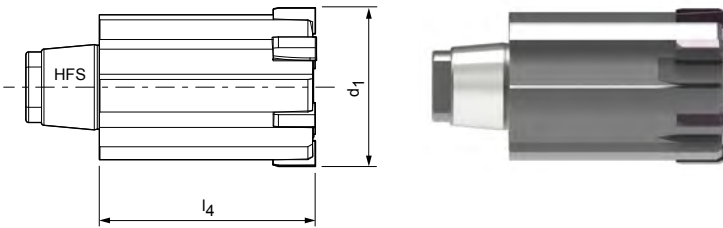

Możliwość konfiguracji parametrów



Tolerancja średnicy otworu IT5/IT6:

- Możliwość wyboru średnicy w krokach co 0,001 mm
- W zależności od zakresu średnicy, dostępne od tolerancji IT5/IT6
- > 030,000 IT5 | ≤ 030,000 IT6

Specyfikacja:

HPR250Ø[średnica][tolerancja]MC1G-HP423

Tolerancja średnicy otworu < IT5/IT6:

- Tolerancje mniejsze niż IT5/IT6 dostępne jako specjalna średnica narzędzia (wariant G – patrz strona 373)

Specyfikacja wariantu G:

HPR250GØ[średnica][tolerancja]MC1G-HP423

Wymiary typoszeregu z możliwością konfiguracji parametrów IT5/IT6

d ₁	l ₄	l ₅	Wielkość HFS	z	Tolerancja
16,600 – 21,290	25	–	10	6	IT6
21,300 – 24,990	27	–	12	6	IT6
25,000 – 28,590	35	–	14	6	IT6
29,000 – 32,290	35	–	16	6	IT5
32,300 – 36,990	41	–	16	6	IT5
37,000 – 41,190	41	–	20	8	IT5
41,200 – 44,900	47	–	20	8	IT5
45,000 – 65,000	47	–	24	8	IT5

Przykład tolerancji IT5:

HPR250Ø35.350H5MC1G-HP423

Średnica otworu d₁ = 35,350 H5

Przykład wariantu G:

HPR250GØ35.350+1-1MC1G-HP423

Średnica specjalna narzędzia d₁ = 35,350 +1 μm -1 μm

Wymiary podano w mm.

Odpowiednie uchwyty wymiennej głowicy HFS od strony 460.

Zalecane parametry skrawania – patrz koniec rozdziału.

Rozwiertak z wymienną głowicą HPR

Wersja z precyzyzną regulacją, prosty rowek wiórowy, do obróbki otworu nieprzelotowego HPR250

Wersja:

Średnica rozwiertaka:

16,600 – 65,000 mm

Nakrój:

MA0A

Materiał skrawający:

PU620

Z ostrzami PCD

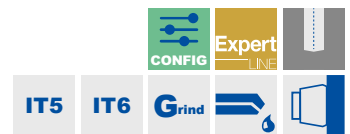
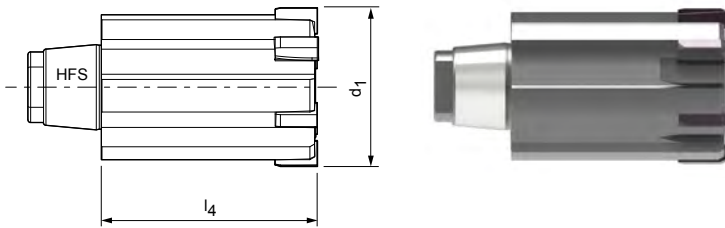

Możliwość konfiguracji parametrów

Tolerancja średnicy otworu IT5/IT6:

- Możliwość wyboru średnicy w krokach co 0,001 mm
- W zależności od zakresu średnicy, dostępne od tolerancji IT5/IT6
- > 030,000 IT5 | ≤ 030,000 IT6

Specyfikacja:

HPR250Ø[średnica][tolerancja]MA0A-PU620

Tolerancja średnicy otworu < IT5/IT6:

- Tolerancje mniejsze niż IT5/IT6 dostępne jako specjalna średnica narzędzia (wariant G – patrz strona 373)

Specyfikacja wariantu G:

HPR250GØ[średnica][tolerancja]MA0A-PU620

Wymiary typoszeregu z możliwością konfiguracji parametrów IT5/IT6

d_1	l_4	l_5	Wielkość HFS	z	Tolerancja
16,600 – 21,290	25	–	10	6	IT6
21,300 – 24,990	27	–	12	6	IT6
25,000 – 28,590	35	–	14	6	IT6
29,000 – 32,290	35	–	16	6	IT5
32,300 – 36,990	41	–	16	6	IT5
37,000 – 41,190	41	–	20	8	IT5
41,200 – 44,900	47	–	20	8	IT5
45,000 – 65,000	47	–	24	8	IT5

Przykład tolerancji IT5:

HPR250Ø35.350H5MA0A-PU620

 Średnica otworu $d_1 = 35,350$ H5

Przykład wariantu G:

HPR250GØ35.350+1-1MA0A-PU620

 Średnica specjalna narzędzia $d_1 = 35,350 + 1 \mu\text{m} - 1 \mu\text{m}$

Wymiary podano w mm.

Odpowiednie uchwyty wymiennej głowicy HFS od strony 460.

Zalecane parametry skrawania – patrz koniec rozdziału.

Rozwiertak z wymienną głowicą HPR

Wersja z precyzyzną regulacją, prosty rowek wiórowy, do obróbki otworu nieprzelotowego HPR250

Wersja:

Średnica rozwiertaka: 16,600 – 65,000 mm
 Nakrój: M02G
 Materiał skrawający: HP625
 Węglik spiekany z powłoką PVD

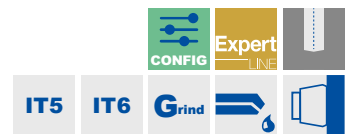
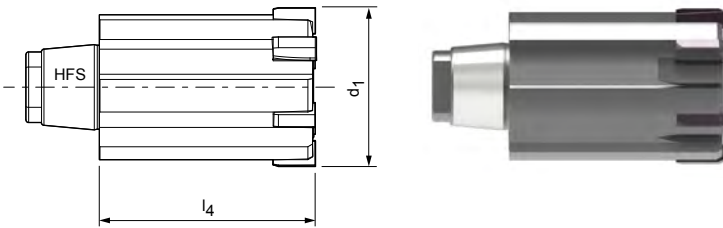

Możliwość konfiguracji parametrów



Tolerancja średnicy otworu IT5/IT6:

- Możliwość wyboru średnicy w krokach co 0,001 mm
- W zależności od zakresu średnicy, dostępne od tolerancji IT5/IT6
- > 030,000 IT5 | ≤ 030,000 IT6

Specyfikacja:

HPR250Ø[średnica][tolerancja]M02G-HP625

Tolerancja średnicy otworu < IT5/IT6:

- Tolerancje mniejsze niż IT5/IT6 dostępne jako specjalna średnica narzędzia (wariant G – patrz strona 373)

Specyfikacja wariantu G:

HPR250GØ[średnica][tolerancja]M02G-HP625

Wymiary typoszeregu z możliwością konfiguracji parametrów IT5/IT6

d ₁	l ₄	l ₅	Wielkość HFS	z	Tolerancja
16,600 – 21,290	25	–	10	6	IT6
21,300 – 24,990	27	–	12	6	IT6
25,000 – 28,590	35	–	14	6	IT6
29,000 – 32,290	35	–	16	6	IT5
32,300 – 36,990	41	–	16	6	IT5
37,000 – 41,190	41	–	20	8	IT5
41,200 – 44,900	47	–	20	8	IT5
45,000 – 65,000	47	–	24	8	IT5

Przykład tolerancji IT5:

HPR250Ø35.350H5M02G-HP625

Średnica otworu d₁ = 35,350 H5

Przykład wariantu G:

HPR250GØ35.350+1-1M02G-HP625

Średnica specjalna narzędzia d₁ = 35,350 +1 μm -1 μm

Wymiary podano w mm.

Odpowiednie uchwyty wymiennej głowicy HFS od strony 460.

Zalecane parametry skrawania – patrz koniec rozdziału.

Zalecane parametry skrawania dla rozwiertaków z wymienną głowicą HPR

Posuw i prędkość skrawania

HPR131 | HPR231 | HPR180 | HPR280

Materiał skrawający: HP421 | Nakrój: ME1G | ML2G

MZG*	Materiał obrabiany	Wytrzymałość/ twardość [N/mm ²] [HRC]	Prędkość cięcia v _c (m/min)			Posuw f _z (mm/z) przy średnicy narzędzia		
			Chłodzenie wewnętrzne	Chłodzenie zewnętrzne	Mgielka	z 4	z 6	
						7,000 - 9,590	9,600 - 21,290	
P	P3.1	Stale narzędziowe, łożyskowe, sprężynowe i stale szybkoobrotowe**	< 800					
	P3.2	Stale narzędziowe, łożyskowe, sprężynowe i stale szybkoobrotowe**	< 1000	100	100	120	0,100	0,200
	P3.3	Stale narzędziowe, łożyskowe, sprężynowe i stale szybkoobrotowe**	< 1500	100	100	120	0,100	0,200
	P5.1	Staliwo		35	35	35	0,070	0,070

HPR150 | HPR250

Materiał skrawający: CU134 | Nakrój: ML2G

MZG*	Materiał obrabiany	Wytrzymałość/ twardość [N/mm ²] [HRC]	Prędkość cięcia v _c (m/min)			Posuw f _z (mm/z) przy średnicy narzędzia		
			Chłodzenie wewnętrzne	Chłodzenie zewnętrzne	Mgielka	z 6	z 8	
						16,600 - 36,990	37,000 - 65,000	
P	P1.1	Stale konstrukcyjne, użytkowe i uszlachetnione, stale niestopowe	< 700	140	100	120	0,200	0,250
	P1.2	Stale konstrukcyjne, użytkowe i uszlachetnione, stale niestopowe	< 1200	140	100	120	0,200	0,250
	P2.1	Stale azotowane, użytkowe i uszlachetnione, stale stopowe	< 900	140	100	120	0,200	0,250
	P2.2	Stale azotowane, użytkowe i uszlachetnione, stale stopowe	< 1400	140	100	120	0,200	0,250
	P3.1	Stale narzędziowe, łożyskowe, sprężynowe i stale szybkoobrotowe**	< 800	140	100	120	0,200	0,250
	P3.2	Stale narzędziowe, łożyskowe, sprężynowe i stale szybkoobrotowe**	< 1000					
	P3.3	Stale narzędziowe, łożyskowe, sprężynowe i stale szybkoobrotowe**	< 1500					

HPR180 | HPR280

Materiał skrawający: CU134 | Nakrój: ML2G

MZG*	Materiał obrabiany	Wytrzymałość/ twardość [N/mm ²] [HRC]	Prędkość cięcia v _c (m/min)			Posuw f _z (mm/z) przy średnicy narzędzia		
			Chłodzenie wewnętrzne	Chłodzenie zewnętrzne	Mgielka	z 4	z 6	
						7,000 - 14,590	14,600 - 21,290	
P	P1.1	Stale konstrukcyjne, użytkowe i uszlachetnione, stale niestopowe	< 700	140	100	120	0,150	0,200
	P1.2	Stale konstrukcyjne, użytkowe i uszlachetnione, stale niestopowe	< 1200	140	100	120	0,150	0,200
	P2.1	Stale azotowane, użytkowe i uszlachetnione, stale stopowe	< 900	140	100	120	0,150	0,200
	P2.2	Stale azotowane, użytkowe i uszlachetnione, stale stopowe	< 1400	140	100	120	0,150	0,200
	P3.1	Stale narzędziowe, łożyskowe, sprężynowe i stale szybkoobrotowe**	< 800	140	100	120	0,150	0,200
	P3.2	Stale narzędziowe, łożyskowe, sprężynowe i stale szybkoobrotowe**	< 1000					
	P3.3	Stale narzędziowe, łożyskowe, sprężynowe i stale szybkoobrotowe**	< 1500					

* Grupa materiałowa wg MAPAL

** Jeśli składniki stopu Cr, Mo, Ni, V, W wynoszą łącznie > 8%, należy wybrać następną w kolejności grupę materiałową MAPAL.

HPR110 | HPR210 | HPR150 | HPR250

Materiał skrawający: HP421 | Nakrój: ME1G | ML2G

MZG*	Materiał obrabiany	Wytrzymałość/ twardość [N/mm ²] [HRC]	Prędkość cięcia v _c (m/min)			Posuw f _z (mm/z) przy średnicy narzędzia		
			Chłodzenie wewnętrzne	Chłodzenie zewnętrzne	Mgielka	z 6	z 8	
						15,600 - 29,990	30,00 - 65,00	
P	P3.1	Stale narzędziowe, łożyskowe, sprężynowe i stale szybko tnące**	< 800	120	100	120	0,200	0,200
	P3.2	Stale narzędziowe, łożyskowe, sprężynowe i stale szybko tnące**	< 1000	100	100	120	0,200	0,200
	P3.3	Stale narzędziowe, łożyskowe, sprężynowe i stale szybko tnące**	< 1500	100	100	120	0,200	0,200
	P5.1	Staliwo		35	35	35	0,070	0,070

HPR110 | HPR210

Materiał skrawający: CU134 | Nakrój: ME1G

MZG*	Materiał obrabiany	Wytrzymałość/ twardość [N/mm ²] [HRC]	Prędkość cięcia v _c (m/min)			Posuw f _z (mm/z) przy średnicy narzędzia			
			Chłodzenie wewnętrzne	Chłodzenie zewnętrzne	Mgielka	z 6	z 8		
						15,600 - 29,990	30,000 - 65,000		
P	P1	P1.1	Stale konstrukcyjne, użytkowe i uszlachetnione, stale niestopowe	< 700	140	100	120	0,200	0,250
		P1.2	Stale konstrukcyjne, użytkowe i uszlachetnione, stale niestopowe	< 1200	140	100	120	0,200	0,250
	P2	P2.1	Stale azotowane, użytkowe i uszlachetnione, stale stopowe	< 900	140	100	120	0,200	0,250
		P2.2	Stale azotowane, użytkowe i uszlachetnione, stale stopowe	< 1400	140	100	120	0,200	0,250
	P3	P3.1	Stale narzędziowe, łożyskowe, sprężynowe i stale szybko tnące**	< 800	140	100	120	0,200	0,250
		P3.2	Stale narzędziowe, łożyskowe, sprężynowe i stale szybko tnące**	< 1000					
P3.3	Stale narzędziowe, łożyskowe, sprężynowe i stale szybko tnące**	< 1500							

HPR131 | HPR231

Materiał skrawający: CU134 | Nakrój: ME1G

MZG*	Materiał obrabiany	Wytrzymałość/ twardość [N/mm ²] [HRC]	Prędkość cięcia v _c (m/min)			Posuw f _z (mm/z) przy średnicy narzędzia			
			Chłodzenie wewnętrzne	Chłodzenie zewnętrzne	Mgielka	z 4	z 6		
						7,000 - 9,590	9,600 - 18,590		
P	P1	P1.1	Stale konstrukcyjne, użytkowe i uszlachetnione, stale niestopowe	< 700	140	100	120	0,150	0,200
		P1.2	Stale konstrukcyjne, użytkowe i uszlachetnione, stale niestopowe	< 1200	140	100	120	0,150	0,200
	P2	P2.1	Stale azotowane, użytkowe i uszlachetnione, stale stopowe	< 900	140	100	120	0,150	0,200
		P2.2	Stale azotowane, użytkowe i uszlachetnione, stale stopowe	< 1400	140	100	120	0,150	0,200
	P3	P3.1	Stale narzędziowe, łożyskowe, sprężynowe i stale szybko tnące**	< 800	140	100	120	0,150	0,200
		P3.2	Stale narzędziowe, łożyskowe, sprężynowe i stale szybko tnące**	< 1000					
P3.3	Stale narzędziowe, łożyskowe, sprężynowe i stale szybko tnące**	< 1500							

Podane parametry skrawania to wartości orientacyjne.

Optymalne wartości dla danego przypadku obróbki należy ustalić w ramach próby lub podczas obróbki.

Zalecane parametry skrawania dla rozwiertaków z wymienną głowicą HPR

Posuw i prędkość skrawania

HPR131 | HPR231 | HPR180 | HPR280

Materiał skrawający: HP421 | Nakrój: MF1G | MO2G

MZG*		Materiał obrabiany	Wytrzymałość/twardość [N/mm ²] [HRC]	Prędkość skrawania v _c (m/min)		
				Chłodzenie wewnętrzne	Chłodzenie zewnętrzne	Mgietka
P	P4	P4.1	Stale nierdzewne, ferrytyczne i martenzytyczne	35	35	35
	P6	P6.1	Staliwo nierdzewne, ferrytyczne i martenzytyczne	35	35	35
M	M1	M1.1	Stale nierdzewne, austenityczne	< 700	35	35
		M1.2	Stale nierdzewne, ferrytyczne/austenityczne (Duplex)	< 1000	35	35
	M2	M2.1	Staliwo nierdzewne, austenityczne	< 700	35	35
	M3	M3.1	Staliwo nierdzewne, ferrytyczne/austenityczne (Duplex)	< 1000	35	35

HPR110 | HPR210 | HPR150 | HPR250

Materiał skrawający: HP421 | Nakrój: MF1G | MO2G

MZG*		Materiał obrabiany	Wytrzymałość/twardość [N/mm ²] [HRC]	Prędkość skrawania v _c (m/min)		
				Chłodzenie wewnętrzne	Chłodzenie zewnętrzne	Mgietka
P	P4	P4.1	Stale nierdzewne, ferrytyczne i martenzytyczne	35	35	35
	P6	P6.1	Staliwo nierdzewne, ferrytyczne i martenzytyczne	35	35	35
M	M1	M1.1	Stale nierdzewne, austenityczne	< 700	35	35
		M1.2	Stale nierdzewne, ferrytyczne/austenityczne (Duplex)	< 1000	35	35
	M2	M2.1	Staliwo nierdzewne, austenityczne	< 700	35	35
	M3	M3.1	Staliwo nierdzewne, ferrytyczne/austenityczne (Duplex)	< 1000	35	35

Posuw f_z (mm/z) przy średnicy narzędzia			
HPR131 HPR231		HPR180 HPR280	
z4	z6	z4	z6
7,000-9,590	9,600-18,590	7,000-14,590	14,600-21,290
0,070	0,070	0,070	0,070
0,070	0,070	0,070	0,070
0,070	0,070	0,070	0,070
0,070	0,070	0,070	0,070
0,070	0,070	0,070	0,070
0,070	0,070	0,070	0,070

Posuw f_z (mm/z) przy średnicy narzędzia			
HPR110 HPR210		HPR150 HPR250	
z6	z8	z6	z8
15,600-29,990	30,000-65,000	16,600-36,990	37,000-65,000
0,070	0,070	0,070	0,070
0,070	0,070	0,070	0,070
0,070	0,070	0,070	0,070
0,070	0,070	0,070	0,070
0,070	0,070	0,070	0,070
0,070	0,070	0,070	0,070

Podane parametry skrawania to wartości orientacyjne.

Optymalne wartości dla danego przypadku obróbki należy ustalić w ramach próby lub podczas obróbki.

Zalecane parametry skrawania dla rozwiertaków z wymienną głowicą HPR

Posuw i prędkość skrawania

HPR130 | HPR230 | HPR180 | HPR280

Materiał skrawający: HP423 | Nakrój: MC1G

MZG*	Materiał obrabiany	Wytrzymałość/twardość [N/mm ²] [HRC]	Prędkość skrawania v _c (m/min)				
			Chłodzenie wewnętrzne	Chłodzenie zewnętrzne	Mgietka		
K	K1	K1.1	Żeliwo z grafitem płatkowym (żeliwo szare), GJL	< 300	140	100	120
		K2.1	Żeliwo sferoidalne, GJS	< 500	140	100	120
	K2	K2.2	Żeliwo sferoidalne, GJS	≤ 800			
		K2.3	Żeliwo sferoidalne, GJS	> 800			

HPR100 | HPR200 | HPR150 | HPR250

Materiał skrawający: CP134 | Nakrój: MC1G

MZG*	Materiał obrabiany	Wytrzymałość/twardość [N/mm ²] [HRC]	Prędkość skrawania v _c (m/min)				
			Chłodzenie wewnętrzne	Chłodzenie zewnętrzne	Mgietka		
K	K1	K1.1	Żeliwo z grafitem płatkowym (żeliwo szare), GJL	< 300	140	100	120
		K2.1	Żeliwo sferoidalne, GJS	< 500	140	100	120
	K2	K2.2	Żeliwo sferoidalne, GJS	≤ 800			
		K2.3	Żeliwo sferoidalne, GJS	> 800			

HPR130 | HPR180

Materiał skrawający: HC419 | Nakrój: MC1G

MZG*	Materiał obrabiany	Wytrzymałość/twardość [N/mm ²] [HRC]	Prędkość skrawania v _c (m/min)				
			Chłodzenie wewnętrzne	Chłodzenie zewnętrzne	Mgietka		
K	K1	K1.1	Żeliwo z grafitem płatkowym (żeliwo szare), GJL	< 300	120	100	120

HPR100 | HPR150

Materiał skrawający: HC419 | Nakrój: MC1G

MZG*	Materiał obrabiany	Wytrzymałość/twardość [N/mm ²] [HRC]	Prędkość skrawania v _c (m/min)				
			Chłodzenie wewnętrzne	Chłodzenie zewnętrzne	Mgietka		
K	K1	K1.1	Żeliwo z grafitem płatkowym (żeliwo szare), GJL	< 300	120	100	120

Posuw f_z (mm/z) przy średnicy narzędzia			
HPR130 HPR230		HPR180 HPR280	
z4	z6	z4	z6
7,000-9,590	9,600-18,590	7,000-14,590	14,600-21,290
0,150	0,200	0,150	0,200
0,150	0,200	0,150	0,200

Posuw f_z (mm/z) przy średnicy narzędzia			
HPR100 HPR200		HPR150 HPR250	
z6	z8	z6	z8
15,600-29,990	30,000-65,000	16,600-36,990	37,000-65,000
0,200	0,300	0,200	0,300
0,200	0,300	0,200	0,300

Posuw f_z (mm/z) przy średnicy narzędzia			
HPR130		HPR180	
z 4	z 6	z 4	z 6
7,000-9,590	9,600-18,590	7,000-14,590	14,600-21,290
0,150	0,200	0,150	0,200

Posuw f_z (mm/z) przy średnicy narzędzia			
HPR100		HPR150	
z6	z8	z6	z8
15,600-29,990	30,000-65,000	16,600-36,990	37,000-65,000
0,150	0,200	0,150	0,200

Podane parametry skrawania to wartości orientacyjne.

Optymalne wartości dla danego przypadku obróbki należy ustalić w ramach próby lub podczas obróbki.

Zalecane parametry skrawania dla rozwiertaków z wymienną głowicą HPR

Posuw i prędkość skrawania

HPR130 | HPR230 | HPR180 | HPR280

Materiał skrawający: HP421 | Nakrój: MC1G

MZG*	Materiał obrabiany	Wytrzymałość/twardość [N/mm ²] [HRC]	Prędkość skrawania v _c (m/min)			
			Chłodzenie wewnętrzne	Chłodzenie zewnętrzne	Mgietka	
K2	K2.1	Żeliwo sferoidalne, GJS	< 500	120	100	120
	K2.2	Żeliwo sferoidalne, GJS	≤ 800			
	K2.3	Żeliwo sferoidalne, GJS	> 800			

HPR100 | HPR200 | HPR150 | HPR250

Materiał skrawający: HP421 | Nakrój: MC1G

MZG*	Materiał obrabiany	Wytrzymałość/twardość [N/mm ²] [HRC]	Prędkość skrawania v _c (m/min)			
			Chłodzenie wewnętrzne	Chłodzenie zewnętrzne	Mgietka	
K2	K2.1	Żeliwo sferoidalne, GJS	< 500	120	100	120
	K2.2	Żeliwo sferoidalne, GJS	≤ 800			
	K2.3	Żeliwo sferoidalne, GJS	> 800			

HPR130 | HPR230 | HPR180 | HPR280

Materiał skrawający: HP423 | Nakrój: MC1G

MZG*	Materiał obrabiany	Wytrzymałość/twardość [N/mm ²] [HRC]	Prędkość skrawania v _c (m/min)				
			Chłodzenie wewnętrzne	Chłodzenie zewnętrzne	Mgietka		
K	K2	K2.1	Żeliwo sferoidalne, GJS	< 500			
		K2.2	Żeliwo sferoidalne, GJS	≤ 800	120	100	120
		K2.3	Żeliwo sferoidalne, GJS	> 800	120	100	120
	K3	K3.1	Żeliwo wermikularne, GJV, (żeliwo ciągliwe), GJL	< 500	90	70	90
		K3.2	Żeliwo wermikularne, GJV, (żeliwo ciągliwe), GJL	> 500	90	70	90

HPR100 | HPR200 | HPR150 | HPR250

Materiał skrawający: HP423 | Nakrój: MC1G

MZG*	Materiał obrabiany	Wytrzymałość/twardość [N/mm ²] [HRC]	Prędkość skrawania v _c (m/min)				
			Chłodzenie wewnętrzne	Chłodzenie zewnętrzne	Mgietka		
K	K2	K2.1	Żeliwo sferoidalne, GJS	< 500			
		K2.2	Żeliwo sferoidalne, GJS	≤ 800	120	100	120
		K2.3	Żeliwo sferoidalne, GJS	> 800	120	100	120
	K3	K3.1	Żeliwo wermikularne, GJV, (żeliwo ciągliwe), GJL	< 500	90	70	90
		K3.2	Żeliwo wermikularne, GJV, (żeliwo ciągliwe), GJL	> 500	90	70	90

Posuw f_z (mm/z) przy średnicy narzędzia			
HPR130 HPR230		HPR180 HPR280	
z4	z6	z4	z6
7,000-9,590	9,600-18,590	7,000-14,590	14,600-21,290
0,150	0,200	0,150	0,200

Posuw f_z (mm/z) przy średnicy narzędzia			
HPR100 HPR200		HPR150 HPR250	
z6	z8	z6	z8
15,600-29,990	30,000-65,000	16,600-36,990	37,000-65,000
0,150	0,200	0,150	0,200

Posuw f_z (mm/z) przy średnicy narzędzia			
HPR130 HPR230		HPR180 HPR280	
z4	z6	z4	z6
7,000-9,590	9,600-18,590	7,000-14,590	14,600-21,290
0,150	0,200	0,150	0,200
0,150	0,200	0,150	0,200
0,150	0,200	0,150	0,200
0,150	0,200	0,150	0,200

Posuw f_z (mm/z) przy średnicy narzędzia			
HPR100 HPR200		HPR150 HPR250	
z6	z8	z6	z8
15,600-29,990	30,000-65,000	16,600-36,990	37,000-65,000
0,150	0,200	0,150	0,200
0,150	0,200	0,150	0,200
0,150	0,200	0,150	0,200
0,150	0,200	0,150	0,200

Podane parametry skrawania to wartości orientacyjne.

Optymalne wartości dla danego przypadku obróbki należy ustalić w ramach próby lub podczas obróbki.

Zalecane parametry skrawania dla rozwiertaków z wymienną głowicą HPR

Posuw i prędkość skrawania

HPR130 | HPR230 | HPR180 | HPR280

Materiał skrawający: PU620 | Nakrój: MA0A

MZG*	Materiał obrabiany	Wytrzymałość/twardość [N/mm ²] [HRC]	Prędkość skrawania v _c (m/min)			
			Chłodzenie wewnętrzne	Chłodzenie zewnętrzne	Mgietka	
N	N1	N1.1 Aluminium, niestopowe i stopowe < 3 % Si	130	100	120	
		N1.2 Aluminium, stopowe ≤ 7 % Si	130	100	120	
		N1.3 Aluminium, stopowe > 7 - 12% Si	130	100	120	
		N1.4 Aluminium, stopowe > 12 % Si	130	100	120	
	N2	N2.1 Miedź, niestopowa i niskostopowa	< 300	130	100	120
		N2.2 Miedź, stopowa	> 300	130	100	120
		N2.3 Mosiądz, brąz, spiż	< 1200	130	100	120

HPR100 | HPR200 | HPR150 | HPR250

Materiał skrawający: PU620 | Nakrój: MA0A

MZG*	Materiał obrabiany	Wytrzymałość/twardość [N/mm ²] [HRC]	Prędkość skrawania v _c (m/min)			
			Chłodzenie wewnętrzne	Chłodzenie zewnętrzne	Mgietka	
N	N1	N1.1 Aluminium, niestopowe i stopowe < 3 % Si	130	100	120	
		N1.2 Aluminium, stopowe ≤ 7 % Si	130	100	120	
		N1.3 Aluminium, stopowe > 7-12 % Si	130	100	120	
		N1.4 Aluminium, stopowe > 12 % Si	130	100	120	
	N2	N2.1 Miedź, niestopowa i niskostopowa	< 300	130	100	120
		N2.2 Miedź, stopowa	> 300	130	100	120
		N2.3 Mosiądz, brąz, spiż	< 1200	130	100	120

Posuw f_z (mm/z) przy średnicy narzędzia			
HPR130 HPR230		HPR180 HPR280	
z4	z6	z4	z6
7,000-9,590	9,600-18,590	7,000-14,590	14,600-21,290
0,150	0,250	0,150	0,250
0,150	0,250	0,150	0,250
0,150	0,250	0,150	0,250
0,150	0,250	0,150	0,250
0,150	0,250	0,150	0,250
0,150	0,250	0,150	0,250
0,150	0,250	0,150	0,250

Posuw f_z (mm/z) przy średnicy narzędzia			
HPR100 HPR200		HPR150 HPR250	
z6	z8	z6	z8
15,600-29,990	30,000-65,000	16,600-36,990	37,000-65,000
0,150	0,250	0,150	0,250
0,150	0,250	0,150	0,250
0,150	0,250	0,150	0,250
0,150	0,250	0,150	0,250
0,150	0,250	0,150	0,250
0,150	0,250	0,150	0,250
0,150	0,250	0,150	0,250

Podane parametry skrawania to wartości orientacyjne.

Optymalne wartości dla danego przypadku obróbki należy ustalić w ramach próby lub podczas obróbki.

Zalecane parametry skrawania dla rozwiertaków z wymienną głowicą HPR

Posuw i prędkość skrawania

HPR180 | HPR280

Materiał skrawający: HP625 | Nakrój: MO2G

MZG*	Materiał obrabiany	Wytrzymałość/ twardość [N/mm ²] [HRC]	Prędkość cięcia v_c (m/min)			Posuw f_z (mm/z) przy średnicy narzędzia		
			Chłodzenie wewnętrzne	Chłodzenie zewnętrzne	Mgiętka	z 4	z 6	
						7,000-14,590	14,600-21,290	
S	S1.1	Tytan, stopy tytanu	< 400	35	20	25	0,060	0,080
	S2.1	Tytan, stopy tytanu	< 1200	35	20	25	0,060	0,080
	S2.2	Tytan, stopy tytanu	> 1200	35	20	25	0,060	0,080
	S3.1	Nikiel, niestopowy i stopowy	< 900	30	15	25	0,060	0,080
	S3.2	Nikiel, niestopowy i stopowy	> 900	30	15	25	0,060	0,080
	S4.1	Nadstop o wysokiej odporności termicznej na bazie Ni, Co i Fe		25	15	20	0,060	0,080
	S5.1	Stopy wolframu i molibdenu		25	15	20	0,060	0,080

HPR131 | HPR231

Materiał skrawający: HP625 | Nakrój: MF1G

MZG*	Materiał obrabiany	Wytrzymałość/ twardość [N/mm ²] [HRC]	Prędkość cięcia v_c (m/min)			Posuw f_z (mm/z) przy średnicy narzędzia		
			Chłodzenie wewnętrzne	Chłodzenie zewnętrzne	Mgiętka	z 4	z 6	
						7,000-9,590	9,600-18,590	
S	S1.1	Tytan, stopy tytanu	< 400	35	20	25	0,060	0,100
	S2.1	Tytan, stopy tytanu	< 1200	35	20	25	0,060	0,100
	S2.2	Tytan, stopy tytanu	> 1200	35	20	25	0,060	0,100
	S3.1	Nikiel, niestopowy i stopowy	< 900	30	15	25	0,060	0,100
	S3.2	Nikiel, niestopowy i stopowy	> 900	30	15	25	0,060	0,100
	S4.1	Nadstop o wysokiej odporności termicznej na bazie Ni, Co i Fe		25	15	20	0,060	0,100
	S5.1	Stopy wolframu i molibdenu		25	15	20	0,060	0,100

HPR110 | HPR210

Materiał skrawający: HP625 | Nakrój: MF1G

MZG*	Materiał obrabiany	Wytrzymałość/ twardość [N/mm ²] [HRC]	Prędkość cięcia v _c (m/min)			Posuw f _z (mm/z) przy średnicy narzędzia		
			Chłodzenie wewnętrzne	Chłodzenie zewnętrzne	Mgiętka	z 6	z 8	
						15,600-29,990	30,000-65,000	
S	S1.1	Tytan, stopy tytanu	< 400	35	20	25	0,100	0,100
	S2.1	Tytan, stopy tytanu	< 1200	35	20	25	0,100	0,100
	S2.2	Tytan, stopy tytanu	> 1200	35	20	25	0,100	0,100
	S3.1	Nikiel, niestopowy i stopowy	< 900	30	15	25	0,100	0,100
	S3.2	Nikiel, niestopowy i stopowy	> 900	30	15	25	0,100	0,100
	S4.1	Nadstop o wysokiej odporności termicznej na bazie Ni, Co i Fe		25	15	20	0,100	0,100
	S5.1	Stopy wolframu i molibdenu		25	15	20	0,100	0,100

HPR150 | HPR250

Materiał skrawający: HP625 | Nakrój: MO2G

MZG*	Materiał obrabiany	Wytrzymałość/ twardość [N/mm ²] [HRC]	Prędkość cięcia v _c (m/min)			Posuw f _z (mm/z) przy średnicy narzędzia		
			Chłodzenie wewnętrzne	Chłodzenie zewnętrzne	Mgiętka	z 6	z 8	
						16,600-36,990	37,000-65,000	
S	S1.1	Tytan, stopy tytanu	< 400	35	20	25	0,080	0,080
	S2.1	Tytan, stopy tytanu	< 1200	35	20	25	0,080	0,080
	S2.2	Tytan, stopy tytanu	> 1200	35	20	25	0,080	0,080
	S3.1	Nikiel, niestopowy i stopowy	< 900	30	15	25	0,080	0,080
	S3.2	Nikiel, niestopowy i stopowy	> 900	30	15	25	0,080	0,080
	S4.1	Nadstop o wysokiej odporności termicznej na bazie Ni, Co i Fe		25	15	20	0,080	0,080
	S5.1	Stopy wolframu i molibdenu		25	15	20	0,080	0,080

Podane parametry skrawania to wartości orientacyjne.

Optymalne wartości dla danego przypadku obróbki należy ustalić w ramach próby lub podczas obróbki.

Naddatki na rozwiercanie

MZG*		Materiał obrabiany	Wytrzymałość/twardość [N/mm ²] [HRC]	
P	P1	P1.1 Stale konstrukcyjne, użytkowe i uszlachetnione, stale niestopowe	< 700	
		P1.2 Stale konstrukcyjne, użytkowe i uszlachetnione, stale niestopowe	< 1200	
	P2	P2.1 Stale azotowane, użytkowe i uszlachetnione, stale stopowe	< 900	
		P2.2 Stale azotowane, użytkowe i uszlachetnione, stale stopowe	< 1400	
	P3	P3.1 Stale narzędziowe, łożyskowe, sprężynowe i stale szybko tnące**	< 800	
		P3.2 Stale narzędziowe, łożyskowe, sprężynowe i stale szybko tnące**	< 1000	
		P3.3 Stale narzędziowe, łożyskowe, sprężynowe i stale szybko tnące**	< 1500	
	P4	P4.1 Stale nierdzewne, ferrytyczne i martenzytyczne		
	P5	P5.1 Staliwo		
	P6	P6.1 Staliwo nierdzewne, ferrytyczne i martenzytyczne		
	M	M1	M1.1 Stale nierdzewne, austenityczne	< 700
			M1.2 Stale nierdzewne, ferrytyczne/austenityczne (Duplex)	< 1000
M2		M2.1 Staliwo nierdzewne, austenityczne	< 700	
M3		M3.1 Staliwo nierdzewne, ferrytyczne/austenityczne (Duplex)	< 1000	
K	K1	K1.1 Żeliwo z grafitem płatkowym (żeliwo szare), GJL	< 300	
		K2.1 Żeliwo sferoidalne, GJS	< 500	
		K2.2 Żeliwo sferoidalne, GJS	≤ 800	
	K2	K2.3 Żeliwo sferoidalne, GJS	> 800	
		K3.1	K3.1 Żeliwo wermikularne, GJV, (żeliwo ciągliwe), GJL	< 500
			K3.2 Żeliwo wermikularne, GJV, (żeliwo ciągliwe), GJL	> 500
N	N1	N1.1 Aluminium, niestopowe i stopowe < 3 % Si		
		N1.2 Aluminium, stopowe ≤ 7 % Si		
		N1.3 Aluminium, stopowe > 7-12 % Si		
		N1.4 Aluminium, stopowe > 12 % Si		
	N2	N2.1 Miedź, niestopowa i niskostopowa	< 300	
		N2.2 Miedź, stopowa	> 300	
		N2.3 Mosiądz, brąz, spiż	< 1200	
	N4	N4.1 Tworzywo sztuczne, materiały termoplastyczne		
		N4.2 Tworzywo sztuczne, duroplast		
		N4.3 Tworzywo sztuczne, pianki		
C	C1	C1.1 Matryca z tworzywa sztucznego, wzmacnianego włóknem aramidowym (AFK)		
		C1.2 Matryca z tworzywa sztucznego (duroplastycznego), CFK/GFK		
		C1.3 Matryca z tworzywa sztucznego (termoplastycznego), CFK/GFK		
	C2	C2.1 Matryca węglowa, wzmacniana włóknem węglowym (CFC)		
S	S1	S1.1 Tytan, stopy tytanu	< 400	
		S2.1 Tytan, stopy tytanu	< 1200	
	S2	S2.2 Tytan, stopy tytanu	> 1200	
		S3.1	S3.1 Nikiel, niestopowy i stopowy	< 900
	S3.2 Nikiel, niestopowy i stopowy		> 900	
	S4	S4.1 Nadstop o wysokiej odporności termicznej na bazie Ni, Co i Fe		
S5	S5.1 Stopy wolframu i molibdenu			
H	H1	H1.1 Stal utwardzana/staliwo	< 44	
		H1.2 Stal utwardzana/staliwo	< 55	
	H2	H2.1 Stal utwardzana/staliwo	< 60	
		H2.2 Stal utwardzana/staliwo	< 65	
		H2.3 Stal utwardzana/staliwo	< 68	
	H3	H3.1 Żeliwo / żeliwo utwardzone, odporne na ścieranie, GJN		

* Grupa materiałowa wg MAPAL

** Jeśli składniki stopu Cr, Mo, Ni, V, W wynoszą łącznie > 8%, należy wybrać następną w kolejności grupę materiałową MAPAL.

	Naddatek a_p [mm] na rozwiercanie				
	< Ø5mm	Ø 5-8 mm	Ø 8-12 mm	Ø 12-18 mm	> Ø18mm
	0,100	0,100	0,150	0,150	0,150
	0,100	0,100	0,100	0,150	0,150
	0,100	0,100	0,150	0,150	0,150
	0,100	0,100	0,100	0,150	0,150
	0,100	0,100	0,150	0,150	0,150
	0,100	0,100	0,150	0,150	0,150
	0,100	0,100	0,100	0,150	0,150
	0,100	0,100	0,100	0,100	0,100
	0,100	0,100	0,100	0,150	0,150
	0,100	0,100	0,100	0,100	0,100
	0,100	0,100	0,100	0,100	0,100
	0,100	0,100	0,100	0,100	0,100
	0,100	0,100	0,100	0,100	0,100
	0,150	0,150	0,150	0,150	0,150
	0,150	0,150	0,150	0,150	0,150
	0,150	0,150	0,150	0,150	0,150
	0,100	0,150	0,150	0,150	0,150
	0,150	0,150	0,150	0,150	0,150
	0,100	0,150	0,150	0,150	0,150
	0,150	0,150	0,150	0,150	0,150
	0,150	0,150	0,150	0,150	0,150
	0,150	0,150	0,150	0,150	0,150
	0,150	0,150	0,150	0,150	0,150
	0,150	0,150	0,150	0,150	0,150
	0,200	0,200	0,200	0,200	0,200
	0,200	0,200	0,200	0,200	0,200
	0,200	0,200	0,200	0,200	0,200
	0,200	0,200	0,200	0,200	0,200
	0,200	0,200	0,200	0,200	0,200
	0,200	0,200	0,200	0,200	0,200
	0,200	0,200	0,200	0,200	0,200
	0,100	0,100	0,100	0,100	0,100
	0,100	0,100	0,100	0,100	0,100
	0,100	0,100	0,100	0,100	0,100
	0,100	0,100	0,100	0,100	0,100
	0,100	0,100	0,100	0,100	0,100
	0,100	0,100	0,100	0,100	0,100
	0,100	0,100	0,100	0,100	0,100
	0,075	0,075	0,075	0,075	0,075
	0,050	0,050	0,075	0,075	0,075
	0,050	0,050	0,075	0,075	0,075
	0,050	0,050	0,075	0,075	0,075
	0,050	0,050	0,075	0,075	0,075
	0,100	0,050	0,075	0,075	0,075

Podane parametry skrawania to wartości orientacyjne.
 Optymalne wartości dla danego przypadku obróbki należy ustalić w ramach próby lub podczas obróbki.

Charakterystyka narzędzi – systemy HFS



Osiowy system mocowania HFS

Dostępny również do złączy modułowych i HSK



- 1 Różne warianty uchwytów
np. chwyt cylindryczny, HSK-A
- 2 Stożek umożliwiający łatwe i bardzo dokładne centrowanie
- 3 Powierzchnia podparcia głowicy zapewniająca sztywność i stabilność
- 4 Wewnętrzne doprowadzenie chłodziwa
Podawanie chłodziwa bezpośrednio na ostrze
- 5 Wysokowytrzymała i precyzyjna śruba mocująca z gwintem różnicowym



Promieniowy system mocowania HFS

Wymiana głowicy szybko, łatwo i bezpośrednio w maszynie

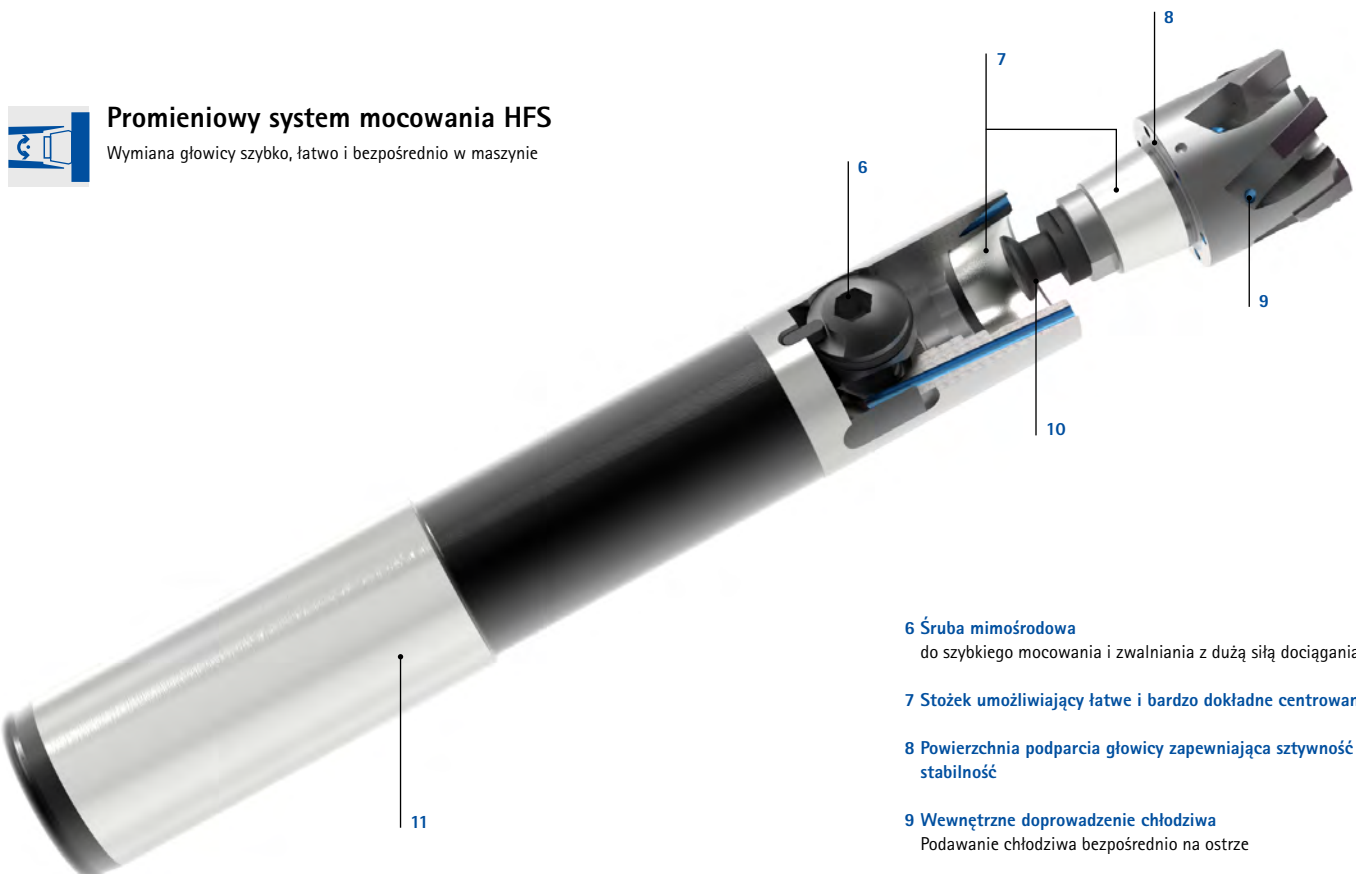

- 6 Śruba mimośrodowa
do szybkiego mocowania i zwalniania z dużą siłą dociągania
- 7 Stożek umożliwiający łatwe i bardzo dokładne centrowanie
- 8 Powierzchnia podparcia głowicy zapewniająca sztywność i stabilność
- 9 Wewnętrzne doprowadzenie chłodziwa
Podawanie chłodziwa bezpośrednio na ostrze
- 10 Precyzyjny sworzeń dociągający
- 11 Różne warianty uchwytów
np. chwyt cylindryczny, HSK-A



Oznaczenia

Uchwyt wymiennej głowicy HFS

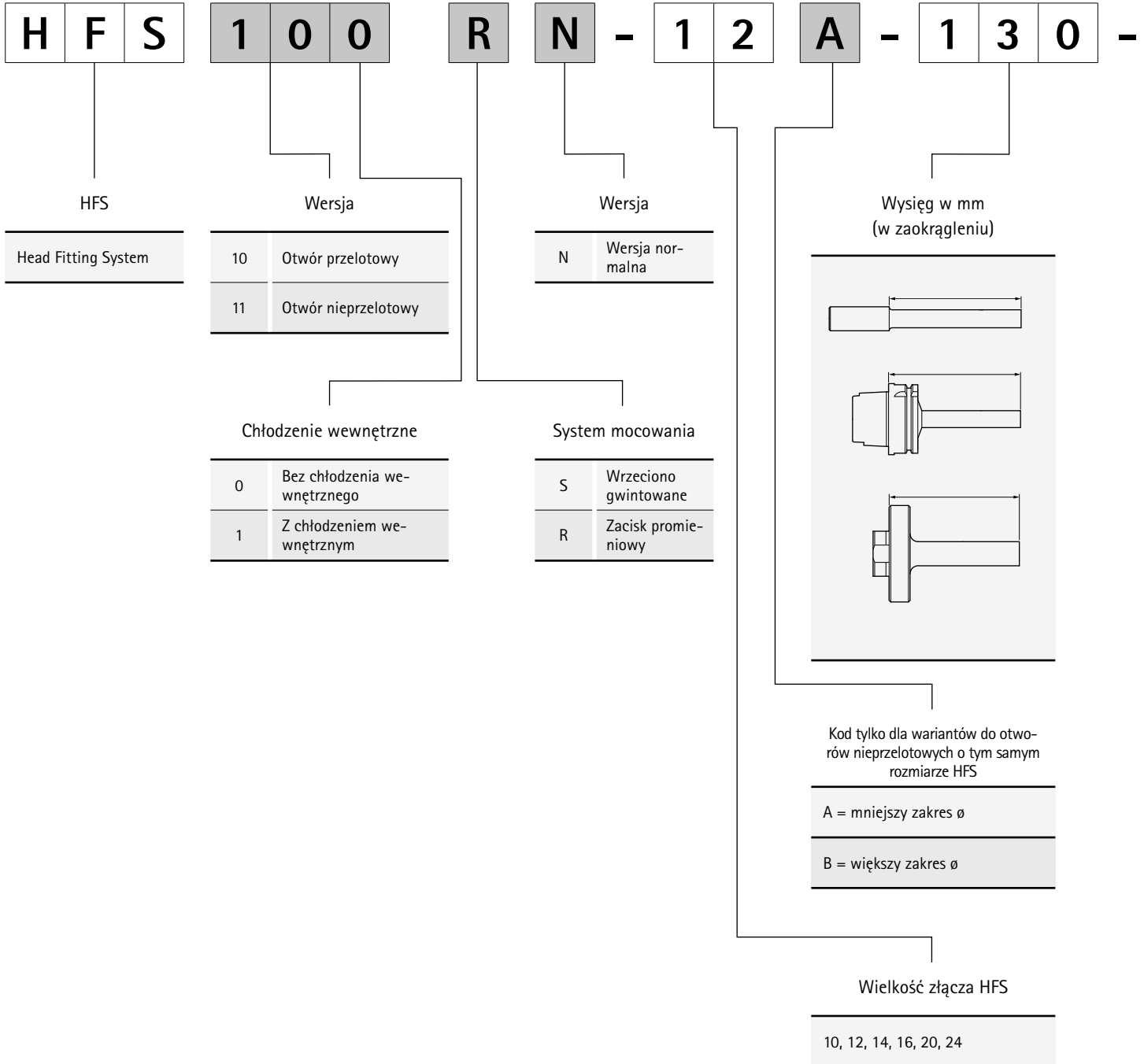

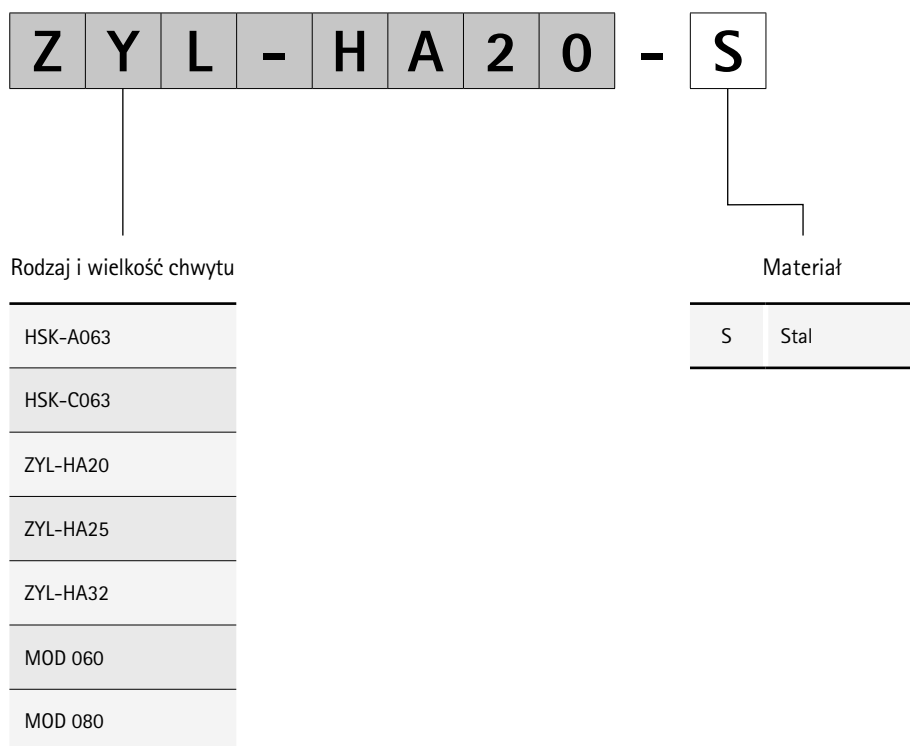

Uchwyt wymiennej głowicy HFS

Z osiowym systemem mocowania

Chwyt wg MN 623, zbliżony do DIN 1835-A

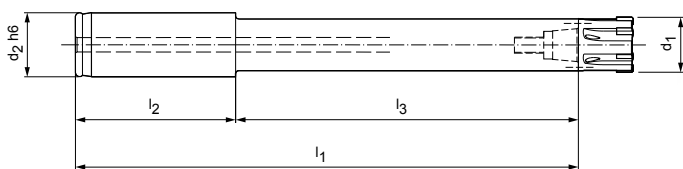

Wersja długa z chwytym cylindrycznym

Wymiary						Specyfikacja	Nr materiałowy
d ₁	Wielkość HFS	d ₂ h6	l ₁	l ₂	l ₃		
15,60 - 18,59	10	20	160	50	110	HFS101SN-10-110-ZYL-HA20-S	30010248
18,60 - 21,29	12	20	179,5	50	129,5	HFS101SN-12-130-ZYL-HA20-S	30010249
21,30 - 23,99	14	20	180,5	50	130,5	HFS101SN-14-131-ZYL-HA20-S	30010250
24,00 - 29,99	16	25	211	60	151	HFS101SN-16-151-ZYL-HA25-S	30010251
30,00 - 39,99	20	25	210	60	150	HFS101SN-20-150-ZYL-HA25-S	30010252
40,00 - 50,70	24	32	266	60	206	HFS101SN-24-206-ZYL-HA32-S	30010253
50,71 - 65,00							

Wersja krótka z chwytym cylindrycznym

Wymiary						Specyfikacja	Nr materiałowy
d ₁	Wielkość HFS	d ₂ h6	l ₁	l ₂	l ₃		
15,60 - 18,59	10	20	99	50	49	HFS101SN-10-049-ZYL-HA20-S	30010256
18,60 - 21,29	12	20	118,5	50	68,5	HFS101SN-12-069-ZYL-HA20-S	30010257
21,30 - 23,99	14	20	119,5	50	69,5	HFS101SN-14-070-ZYL-HA20-S	30010258
24,00 - 29,99	16	25	150	60	90	HFS101SN-16-090-ZYL-HA25-S	30010259
30,00 - 39,99	20	25	149	60	89	HFS101SN-20-089-ZYL-HA25-S	30010260
40,00 - 50,70	24	32	167	60	107	HFS101SN-24-107-ZYL-HA32-S	30010261
50,71 - 65,00							

Wersja bardzo krótka z chwytym cylindrycznym

Wymiary						Specyfikacja	Nr materiałowy
d ₁	Wielkość HFS	d ₂ h6	l ₁	l ₂	l ₃		
18,60 - 21,29	12	20	82	50	32	HFS101SN-12-032-ZYL-HA20-S	30078683

Wymiary podano w mm.

Zakres dostawy: Uchwyt z wrzecionem gwintowanym i wkrętek z uchwytem poprzecznym.

Uchwyt wymiennej głowicy HFS

Z osiowym systemem mocowania

Chwył wg MN 623, zbliżony do DIN 1835-A

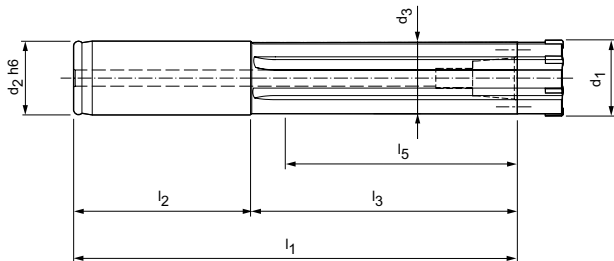

Wersja długa z chwytem cylindrycznym

Wymiary								Specyfikacja	Nr materiałowy
d ₁	Wielkość HFS	d ₂ h6	d ₃	l ₁	l ₂	l ₃	l ₅		
16,60 - 19,39	10	20	16	160	50	110	94	HFS111SN-10A-110-ZYL-HA20-S	30026380
19,40 - 21,29	10	20	18,6	160	50	110	94	HFS111SN-10B-110-ZYL-HA20-S	30026488
21,30 - 24,99	12	20	20,5	180,5	50	130,5	114,5	HFS111SN-12-131-ZYL-HA20-S	30026489
25,00 - 28,99	14	25	24,2	211,5	60	151,5	132,5	HFS111SN-14-152-ZYL-HA25-S	30026510
29,00 - 32,29	16	25	28,2	210	60	150	131	HFS111SN-16A-150-ZYL-HA25-S	30026511
32,30 - 36,99	16	25	31,5	210	60	150	140	HFS111SN-16B-150-ZYL-HA25-S	30026512
37,00 - 41,19	20	25	36,2	210	60	150	140	HFS111SN-20A-150-ZYL-HA25-S	30026513
41,20 - 44,99	20	25	40,2	210	60	150	140	HFS111SN-20B-150-ZYL-HA25-S	30026514
45,00 - 50,70	24	32	44	266	60	206	195	HFS111SN-24-206-ZYL-HA32-S	30026515
50,71 - 65,00									

Wersja krótka z chwytem cylindrycznym

Wymiary								Specyfikacja	Nr materiałowy
d ₁	Wielkość HFS	d ₂ h6	d ₃	l ₁	l ₂	l ₃	l ₅		
16,60 - 19,39	10	20	16	99	50	49	33	HFS111SN-10A-049-ZYL-HA20-S	30026516
19,40 - 21,29	10	20	18,6	99	50	49	33	HFS111SN-10B-049-ZYL-HA20-S	30026521
21,30 - 24,99	12	20	20,5	117,5	50	67,5	51,5	HFS111SN-12-068-ZYL-HA20-S	30026522
25,00 - 28,99	14	25	24,2	150,5	60	90,5	71,5	HFS111SN-14-091-ZYL-HA25-S	30026523
29,00 - 32,29	16	25	28,2	149	60	89	70	HFS111SN-16A-089-ZYL-HA25-S	30026525
32,30 - 36,99	16	25	31,5	149	60	89	79	HFS111SN-16B-089-ZYL-HA25-S	30026526
37,00 - 41,19	20	25	36,2	149	60	89	79	HFS111SN-20A-089-ZYL-HA25-S	30026527
41,20 - 44,99	20	25	40,2	149	60	89	79	HFS111SN-20B-089-ZYL-HA25-S	30026528
45,00 - 50,70	24	32	44	167	60	107	96	HFS111SN-24-107-ZYL-HA32-S	30026529
50,71 - 65,00									

Wymiary podano w mm.

Zakres dostawy: Uchwyt z wrzecionem gwintowanym i wkretek z uchwytem poprzecznym.

Uchwyt wymiennej głowicy HFS

Z osiowym systemem mocowania z kompensacją bicia promieniowego i kąтового
Rozmiary złącza modułowego wg MN 5000-14

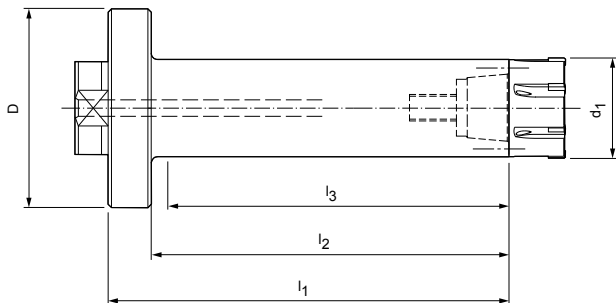

Wersja długa z chwytem modułowym (z kompensacją bicia promieniowego i kąтового)

Wymiary						Specyfikacja	Nr materiałowy
d ₁	Wielkość HFS	D	l ₁	l ₂	l ₃		
15,60 - 18,59	10	60	81	68	61	HFS101SN-10-081-MOD-060-S	30010264
18,60 - 21,29	12	60	100,5	87,5	80,5	HFS101SN-12-101-MOD-060-S	30010265
21,30 - 23,99	14	60	101,5	88,5	79,5	HFS101SN-14-102-MOD-060-S	30010266
24,00 - 29,99	16	60	122	109	104	HFS101SN-16-122-MOD-060-S	30010267
30,00 - 39,99	20	60	121	108	103	HFS101SN-20-121-MOD-060-S	30010268
40,00 - 50,70	24	60	133	120	116	HFS101SN-24-133-MOD-060-S	30010269
50,71 - 65,00	24	80	133	116	112	HFS101SN-24-133-MOD-080-S	30190195



Części zamienne do chwytu modułowego

Wielkość modułu D	Śruba z łbem walcowym wg ISO 4762 (DIN 912)			Element dociskowy		Trzpień gwintowany	
	potrzebna ilość	Wielkość	Nr materiałowy	Wielkość	Nr materiałowy	Wielkość	Nr materiałowy
60	4	M5x16-12,9	10003601	10,6x5	10040108	M8x1x8	10040109
80	4	M6x20-12,9	10003619	10,6x5	10040108	M8x1x11,5	10075074

Wymiary podano w mm.

Zakres dostawy: Uchwyt z wrzecionem gwintowanym, wkrętak z uchwytem poprzecznym, śruby mocujące do chwytu modułowego i elementy do kompensacji bicia kąтового chwytu modułowego.

Uchwyt wymiennej głowicy HFS

Z osiowym systemem mocowania z kompensacją bicia promieniowego i kąтового
Rozmiary złącza modułowego wg MN 5000-14

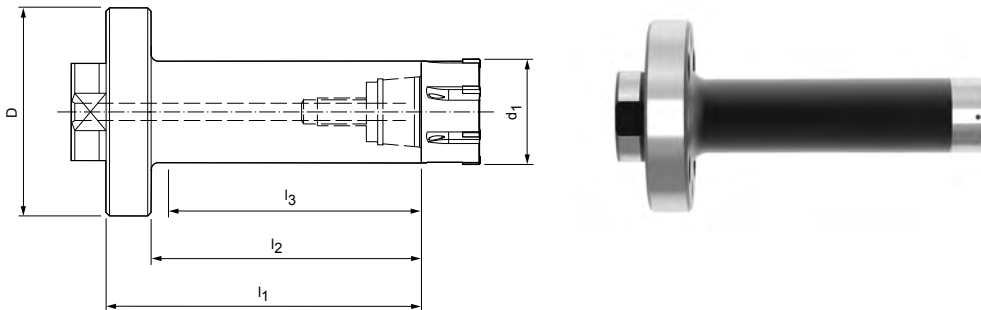

Wersja krótka z chwytem modułowym (z kompensacją bicia promieniowego i kąтового)

Wymiary						Specyfikacja	Nr materiałowy
d ₁	Wielkość HFS	D	l ₁	l ₂	l ₃		
15,60 - 18,59	10	60	49	36	31	HFS101SN-10-049-MOD-060-S	30027896
18,60 - 21,29	12	60	58,5	45,5	40,5	HFS101SN-12-059-MOD-060-S	30027897
21,30 - 23,99	14	60	62,5	49,5	44,5	HFS101SN-14-063-MOD-060-S	30027898
24,00 - 29,99	16	60	72	59	54	HFS101SN-16-072-MOD-060-S	30027899
30,00 - 39,99	20	60	71	58	53	HFS101SN-20-071-MOD-060-S	30027900
40,00 - 50,70	24	60	84	71	66	HFS101SN-24-084-MOD-060-S	30027901
50,71 - 65,00	24	80	84	67	62	HFS101SN-24-084-MOD-080-S	30152510



Części zamienne do chwyty modułowego

Wielkość modułu D	Śruba z łbem walcowym wg ISO 4762 (DIN 912)			Element dociskowy		Trzpień gwintowany	
	potrzebna ilość	Wielkość	Nr materiałowy	Wielkość	Nr materiałowy	Wielkość	Nr materiałowy
60	4	M5x16-12,9	10003601	10,6x5	10040108	M8x1x8	10040109
80	4	M6x20-12,9	10003619	10,6x5	10040108	M8x1x11,5	10075074

Wymiary podano w mm.

Zakres dostawy: Uchwyt z wrzecionem gwintowanym, wkrętak z uchwytem poprzecznym, śruby mocujące do chwyty modułowego i elementy do kompensacji bicia kąowego chwyty modułowego.

Uchwyt wymiennej głowicy HFS

Z osiowym systemem mocowania z kompensacją bicia promieniowego i kąтового
Rozmiary złącza modułowego wg MN 5000-14

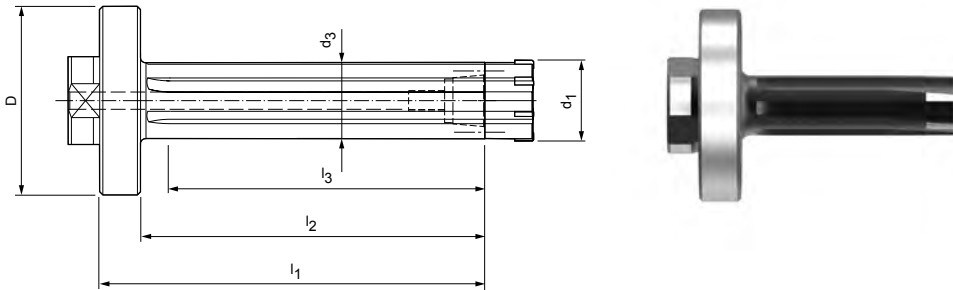

Wersja długa z chwytem modułowym (z kompensacją bicia promieniowego i kąтового)

Wymiary							Specyfikacja	Nr materiałowy
d ₁	Wielkość HFS	D	d ₃	l ₁	l ₂	l ₃		
16,60 - 19,39	10	60	16	81	68	48	HFS111SN-10A-081-MOD-060-S	30026562
19,40 - 21,29	10	60	18,6	81	68	48	HFS111SN-10B-081-MOD-060-S	30026563
21,30 - 24,99	12	60	20,5	101,5	88,5	69,5	HFS111SN-12-102-MOD-060-S	30026564
25,00 - 28,99	14	60	24,2	122,5	109,5	90,5	HFS111SN-14-123-MOD-060-S	30026565
29,00 - 32,29	16	60	28,2	121	108	89	HFS111SN-16A-121-MOD-060-S	30026566
32,30 - 36,99	16	60	31,5	121	108	89	HFS111SN-16B-121-MOD-060-S	30026567
37,00 - 41,19	20	60	36,2	121	108	89	HFS111SN-20A-121-MOD-060-S	30026568
41,20 - 44,99	20	60	40,2	121	108	89	HFS111SN-20B-121-MOD-060-S	30026569
45,00 - 50,70	24	60	44	123	110	95	HFS111SN-24-123-MOD-060-S	30026570
50,71 - 65,00	24	80	44	133	116	110	HFS111SN-24-133-MOD-080-S	30193167



Części zamienne do chwyty modułowego

Wielkość modułu D	Śruba z łbem walcowym wg ISO 4762 (DIN 912)			Element dociskowy		Trzpień gwintowany	
	potrzebna ilość	Wielkość	Nr materiałowy	Wielkość	Nr materiałowy	Wielkość	Nr materiałowy
60	4	M5x16-12,9	10003601	10,6x5	10040108	M8x1x8	10040109
80	4	M6x20-12,9	10003619	10,6x5	10040108	M8x1x11,5	10075074

Wymiary podano w mm.

Zakres dostawy: Uchwyt z wrzecionem gwintowanym, wkrętak z uchwytem poprzecznym, śruby mocujące do chwyty modułowego i elementy do kompensacji bicia kąowego chwyty modułowego.

Uchwyt wymiennej głowicy HFS

Z osiowym systemem mocowania z kompensacją bicia promieniowego i kąowego
Rozmiary złącza modułowego wg MN 5000-14

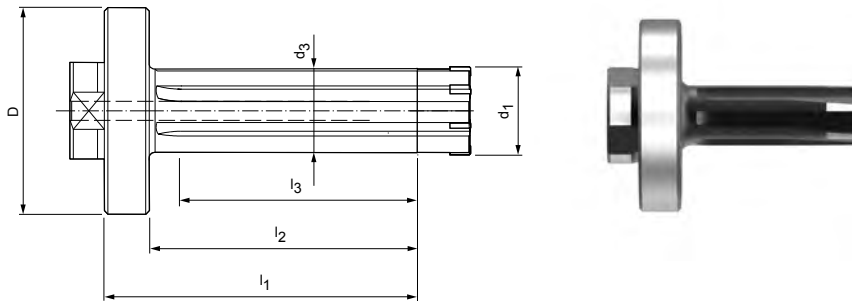

Wersja krótka z chwytem modułowym (z kompensacją bicia promieniowego i kąowego)

Wymiary							Specyfikacja	Nr materiałowy
d ₁	Wielkość HFS	D	d ₃	l ₁	l ₂	l ₃		
16,60 - 19,39	10	60	16	49	36	31	HFS111SN-10A-049-MOD-060-S	30027885
19,40 - 21,29	10	60	18,6	59	46	41	HFS111SN-10B-059-MOD-060-S	30027886
21,30 - 24,99	12	60	20,5	62,5	49,5	44,5	HFS111SN-12-063-MOD-060-S	30027887
25,00 - 28,99	14	60	24,2	72,5	59,5	54,5	HFS111SN-14-073-MOD-060-S	30027888
29,00 - 32,29	16	60	28,2	71	58	53	HFS111SN-16A-071-MOD-060-S	30027889
32,30 - 36,99	16	60	31,5	71	58	53	HFS111SN-16B-071-MOD-060-S	30027890
37,00 - 41,19	20	60	36,2	71	58	53	HFS111SN-20A-071-MOD-060-S	30027891
41,20 - 44,99	20	60	40,2	81	68	63	HFS111SN-20B-081-MOD-060-S	30027892
45,00 - 50,70	24	60	44	84	71	66	HFS111SN-24-084-MOD-060-S	30027893
50,71 - 65,00	24	80	44	84	67	64	HFS111SN-24-084-MOD-080-S	30193168



Części zamienne do chwytu modułowego

Wielkość modułu D	Śruba z łbem walcowym wg ISO 4762 (DIN 912)			Element dociskowy		Trzpień gwintowany	
	potrzebna ilość	Wielkość	Nr materiałowy	Wielkość	Nr materiałowy	Wielkość	Nr materiałowy
60	4	M5x16-12,9	10003601	10,6x5	10040108	M8x1x8	10040109
80	4	M6x20-12,9	10003619	10,6x5	10040108	M8x1x11,5	10075074

Wymiary podano w mm.

Zakres dostawy: Uchwyt z wrzecionem gwintowanym, wkrętak z uchwytem poprzecznym, śruby mocujące do chwytu modułowego i elementy do kompensacji bicia kąowego chwytu modułowego.

Uchwyt wymiennej głowicy HFS

Z osiowym systemem mocowania

Chwyt HSK-A według DIN 69893-1

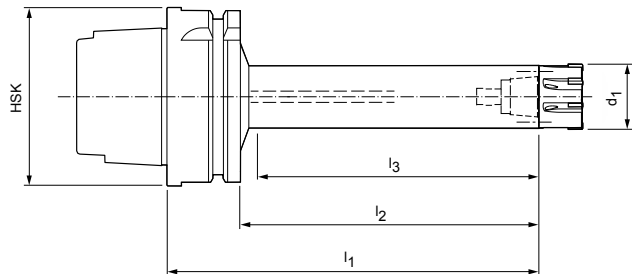

Wersja długa z HSK-A 63

Wymiary						Specyfikacja	Nr materiałowy
d ₁	Wielkość HFS	l ₁	l ₂	l ₃	Wielkość HSK-A		
15,60 - 18,59	10	117	91	86	63	HFS101SN-10-117-HSK-A063-S	30010272
18,60 - 21,29	12	132,5	106,5	100,5	63	HFS101SN-12-133-HSK-A063-S	30010273
21,30 - 23,99	14	131,5	105,5	99,5	63	HFS101SN-14-132-HSK-A063-S	30010275
24,00 - 29,99	16	163	137	129	63	HFS101SN-16-163-HSK-A063-S	30010276
30,00 - 39,99	20	188	162	158	63	HFS101SN-20-188-HSK-A063-S	30010280
40,00 - 50,70	24	207	181	176	63	HFS101SN-24-207-HSK-A063-S	30010286
50,71 - 65,00							

Wersja krótka z HSK-A 63

Wymiary						Specyfikacja	Nr materiałowy
d ₁	Wielkość HFS	l ₁	l ₂	l ₃	Wielkość HSK-A		
15,60 - 18,59	10	77	51	46	63	HFS101SN-10-077-HSK-A063-S	30010283
18,60 - 21,29	12	92,5	66,5	60,5	63	HFS101SN-12-093-HSK-A063-S	30010285
21,30 - 23,99	14	91,5	65,5	59,5	63	HFS101SN-14-092-HSK-A063-S	30010287
24,00 - 29,99	16	112	86	79	63	HFS101SN-16-112-HSK-A063-S	30010288
30,00 - 39,99	20	111	85	78	63	HFS101SN-20-111-HSK-A063-S	30010289
40,00 - 50,70	24	109	83	76	63	HFS101SN-24-109-HSK-A063-S	30010291
50,71 - 65,00							

Wymiary podano w mm.

Zakres dostawy: Uchwyt z wrzecionem gwintowanym i wkrętek z uchwytem poprzecznym.

Uchwyt wymiennej głowicy HFS

Z osiowym systemem mocowania

Chwyć HSK-A według DIN 69893-1

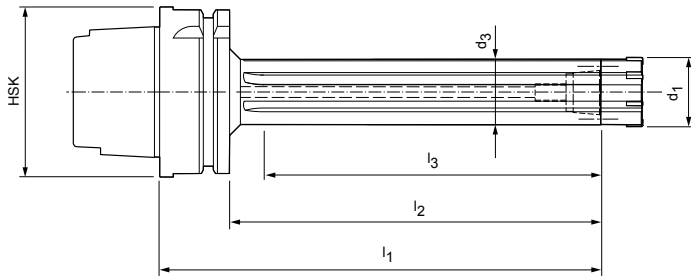

Wersja długa z HSK-A 63

Wymiary							Specyfikacja	Nr materiałowy
d ₁	Wielkość HFS	d ₃	l ₁	l ₂	l ₃	Wielkość HSK-A		
16,60 - 19,39	10	16,0	117	91	71	63	HFS111SN-10A-117-HSK-A063-S	30026586
19,40 - 21,29	10	18,6	117	91	71	63	HFS111SN-10B-117-HSK-A063-S	30026587
21,30 - 24,99	12	20,5	131,5	105,5	86,5	63	HFS111SN-12-132-HSK-A063-S	30026588
25,00 - 28,99	14	24,2	163,5	137,5	118,5	63	HFS111SN-14-164-HSK-A063-S	30026589
29,00 - 32,29	16	28,2	188	162	143	63	HFS111SN-16A-188-HSK-A063-S	30026590
32,30 - 36,99	16	31,5	188	162	143	63	HFS111SN-16B-188-HSK-A063-S	30026591
37,00 - 41,19	20	36,2	188	162	152	63	HFS111SN-20A-188-HSK-A063-S	30026592
41,20 - 44,99	20	40,2	188	162	152	63	HFS111SN-20B-188-HSK-A063-S	30026593
45,00 - 50,70	24	44,0	233	207	197	63	HFS111SN-24-233-HSK-A063-S	30026594
50,71 - 65,00								

Wersja krótka z HSK-A 63

Wymiary							Specyfikacja	Nr materiałowy
d ₁	Wielkość HFS	d ₃	l ₁	l ₂	l ₃	Wielkość HSK-A		
16,60 - 19,39	10	16,0	77	51	31	63	HFS111SN-10A-077-HSK-A063-S	30026574
19,40 - 21,29	10	18,6	77	51	31	63	HFS111SN-10B-077-HSK-A063-S	30026575
21,30 - 24,99	12	20,5	91,5	65,5	46,5	63	HFS111SN-12-092-HSK-A063-S	30026576
25,00 - 28,99	14	24,2	112,5	86,5	67,5	63	HFS111SN-14-113-HSK-A063-S	30026577
29,00 - 32,29	16	28,2	111	85	66	63	HFS111SN-16A-111-HSK-A063-S	30026578
32,30 - 36,99	16	31,5	111	85	66	63	HFS111SN-16B-111-HSK-A063-S	30026579
37,00 - 41,19	20	36,2	111	85	75	63	HFS111SN-20A-111-HSK-A063-S	30026580
41,20 - 44,99	20	40,2	111	85	75	63	HFS111SN-20B-111-HSK-A063-S	30026581
45,00 - 50,70	24	44,0	109	83	73	63	HFS111SN-24-109-HSK-A063-S	30026582
50,71 - 65,00								

Wymiary podano w mm.

Zakres dostawy: Uchwyt z wrzecionem gwintowanym i wkrętak z uchwytem poprzecznym.

Uchwyt wymiennej głowicy HFS

Z promieniowym systemem mocowania, chwyt wg MN 623, zbliżony do DIN 1835-A
Do rozwiertaków z wymienną głowicą HPR HPR100, HPR110, HPR200, HPR210

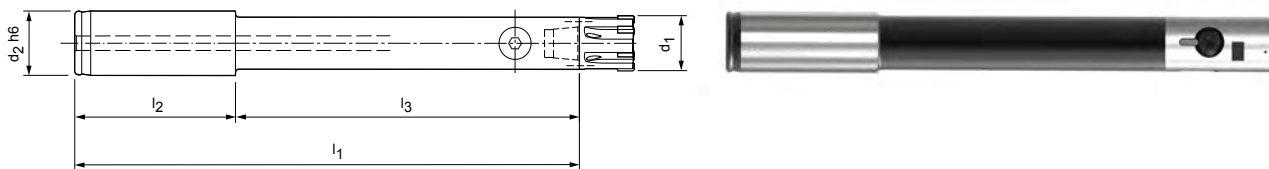

Wersja długa z chwytem cylindrycznym

Wymiary						Specyfikacja	Nr materiałowy
d ₁	Wielkość HFS	d ₂ h6	l ₁	l ₂	l ₃		
18,60 - 21,29	12	20	179,5	50	129,5	HFS101RN-12-130-ZYL-HA20-S	30078110
21,30 - 23,99	14	20	180,5	50	130,5	HFS101RN-14-131-ZYL-HA20-S	30078115
24,00 - 29,99	16	25	211	60	151	HFS101RN-16-151-ZYL-HA25-S	30078116
30,00 - 39,99	20	25	210	60	150	HFS101RN-20-150-ZYL-HA25-S	30080112

Wersja krótka z chwytem cylindrycznym

Wymiary						Specyfikacja	Nr materiałowy
d ₁	Wielkość HFS	d ₂ h6	l ₁	l ₂	l ₃		
18,60 - 21,29	12	20	118,5	50	68,5	HFS101RN-12-069-ZYL-HA20-S	30078117
21,30 - 23,99	14	20	119,5	50	69,5	HFS101RN-14-070-ZYL-HA20-S	30078118
24,00 - 29,99	16	25	150	60	90	HFS101RN-16-090-ZYL-HA25-S	30078119
30,00 - 39,99	20	25	149	60	89	HFS101RN-20-089-ZYL-HA25-S	30080151

Wersja bardzo krótka z chwytem cylindrycznym

Wymiary						Specyfikacja	Nr materiałowy
d ₁	Wielkość HFS	d ₂ h6	l ₁	l ₂	l ₃		
18,60 - 21,29	12	20	85	50	35	HFS101RN-12-035-ZYL-HA20-S	30115560

Wymiary podano w mm.

Zalecenie: W celu szybkiej wymiany rozwiertaków z promieniowym systemem mocowania konieczne jest zamówienie co najmniej jednego dodatkowego sworznia dociągającego.
Zakres dostawy: Uchwyt ze sworzniem dociągającym, wkrętak z uchwytem poprzecznym i klucz płaski do sworznia dokręcającego.



Osprzęt i części zamienne do HFS

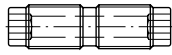
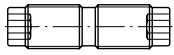

Śruby mocujące do osiowego systemu mocowania

Wielkość HFS	bez przepływu chłodziwa, wrzeczono gwintowane MN 618 Nr materiałowy	z przepływem chłodziwa, wrzeczono gwintowane MN 618 Nr materiałowy
10	10024720	10025194
12	10024721	10025195
14	10024721	10025195
16	10024722	10025196
20	10024722	10025196
24	10024723	10025198

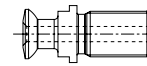
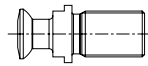

Sworznie dociągające do promieniowego systemu mocowania

Wielkość HFS	bez otworu doprowadzającego chłodziwo Nr materiałowy	z otworem doprowadzającym chłodziwo Nr materiałowy
12	10059113	10059273
14	10059113	10059273
16	10059117	10059279
20	10059117	10059279

Zalecenie: W celu szybkiej wymiany rozwiertaków z promieniowym systemem mocowania konieczne jest zamówienie co najmniej jednego dodatkowego sworznia dociągającego.

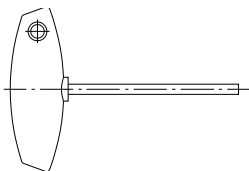

Wkrętaki z uchwytem poprzecznym

Wielkość HFS	wersja krótka		wersja długa	
	Wielkość	Nr materiałowy	Wielkość	Nr materiałowy
10	sw2,5 x 100	10006233	sw2,5 x 200	10032722
12	sw3 x 100	10006234	sw3 x 200	10025313
14	sw3 x 100	10006234	sw3 x 200	10025313
16	sw4 x 100	10006235	sw4 x 200	10018010
20	sw4 x 100	10006235	sw4 x 200	10018010
24	sw5 x 100	10006236	sw5 x 200	10013349

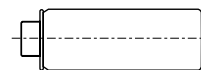

Wycior stożkowy do stożka wewnętrznego HFS

Wielkość HFS	Nr materiałowy
10	10029989
12	10029990
14	10030002
16	10030003
20	10030004
24	10030005

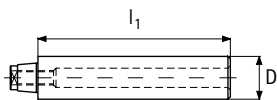

Trzpienie pomiarowe (narzędzie pomocnicze do regulacji)

Wielkość HFS	l_1	D	Nr materiałowy
10	70	15	30036468
12	80	20	30036469
14	80	20,5	30036470
16	80	23,2	30036471
20	80	29,3	30036472
24	80	39	30036473

Wymiary podano w mm.

Wersja: Dopuszczalna odchyłka wartości bicia części cylindrycznej w stosunku do złącza HFS maks. 0,002 mm.

Osprzęt i części zamienne do HSK-A 63

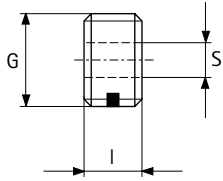

Zaślepka

Wielkość HSK-A	I	S	G	Nr materiałowy
63	11,5	8	M18x1	30326078

Wielkość HFS	sw	Klucz dynamometryczny				Końcówki i wkładki sześciokątne do kluczy dynamometrycznych			
		Moment obrotowy	Wersja	Napęd	Nr materiałowy	l [mm]	l ₁ [mm]	Napęd	Nr materiałowy
10	2.5	4 Nm	stałe – z końcówką	–	10044842	175	70	końcówka	10044839
12	3	6 Nm	nastawne – bez wkładki	1/4"	10040125	55	30	wkładka 1/4"	10040122
14	3	6 Nm	nastawne – bez wkładki	1/4"	10040125	55	30	wkładka 1/4"	10040122
16	4	15 Nm	nastawne – bez wkładki	3/8"	10040126	60	35	wkładka 3/8"	10040123
20	4	15 Nm	nastawne – bez wkładki	3/8"	10040126	60	35	wkładka 3/8"	10040123
24	5	20 Nm	nastawne – bez wkładki	3/8"	10040126	70	45	wkładka 3/8"	10040124

Klucze dynamometryczne i wkładki sześciokątne od wielkości HFS 12 lub sw 3.

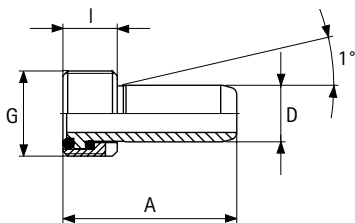

Rurka doprowadzająca chłodziwo

Wielkość HSK-A	A	I	G	D	Nr materiałowy
63	36.6	11,5	M18x1	12	30326006

Zakres dostawy: rurka doprowadzająca chłodziwo z dwoma uszczelnkami typu O-Ring.

Wersja: z lekkim luzem kątowym 1°, samocentrująca, uszczelniania.

Informacja: wykonana wg DIN 69893.

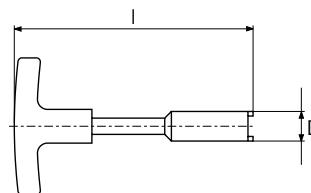

Klucz montażowy

Wielkość HSK-A	I	D	Nr materiałowy
63	182	17	10040110

Zastosowanie: do montażu i demontażu rurek doprowadzających chłodziwo.

Wymiary podano w mm.

Zastosowanie: do zamykania otworów gwintowanych w chwytach narzędzi GKZ, gdy nie jest stosowana rurka doprowadzająca chłodziwo.

Wersja: z wkładem Nylok do zabezpieczenia śruby.

Materiał: Stal nierdzewna.



NARZĘDZIA Z LISTWAMI PROWADZĄCYMI

Narzędzia z listwami prowadzącymi

Zestawienie modeli rozwiertaków jednoostrzowych	478
Oznaczenia	480

Rozwiertaki jednoostrzowe WP

MN2000	484
MN2003	486
MN2004	488
MN2034	489
MN2023	490
MN2024	491
MN2043	492
MN2044	493
Nakroje płytek skrawających AS AZ DZ EK SZ 	494
Zalecane parametry skrawania	504

System EasyAdjust

Przegląd produktów, obsługa i przegląd systemu	514
Zbieżność ostrzy	516
Zestawienie modeli	517
Płytki skrawające HX do systemu EA	518
Płytki skrawające TEC do systemu EA	520
Osprzęt	522
Zalecane parametry skrawania	524

Narzędzia do obróbki zewnętrznej







Przegląd produktów, obsługa i przegląd systemu	538
Płytki skrawające TEC	540
Płytki skrawające	542
Osprzęt	544
Zalecane parametry skrawania	546

Aneks techniczny

Informacje dotyczące obsługi	737
------------------------------------	-----

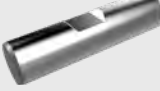
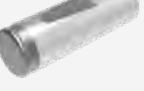

Zestawienie modeli – rozwiertaki jednostrzowe

Koncepcja maszyny	Rodzaj doprowadzenia chłodziwa		Rodzaj otworu		Liczba ostrzy	Typ chwytu	
							
Rozwiertaki jednostrzowe	Maszyny wiertarskie		✓	✓	1	 Chwyt stożkowy Morse'a	
Rozwiertaki jednostrzowe	Automaty tokarskie (z uchwytem pływającym)	✓		✓	1	 Chwyt cylindryczny z powierzchnią mocującą	
		✓			✓		1
		✓			✓		1
Rozwiertaki jednostrzowe	Centra obróbcze	✓		✓	1	 Chwyt cylindryczny z powierzchnią mocującą NC	
		✓			✓		1
		✓		✓		1	 Chwyt cylindryczny gładki
		✓			✓	1	

Nakroje płytek skrawających MAPAL

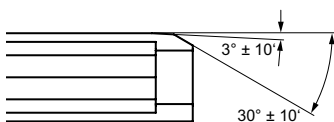

Nakrój AS

Nakrój odpowiedni do wszystkich materiałów, wysoka jakość powierzchni nawet przy dużych prędkościach skrawania. Długość nakroju 1,3 mm.

Maks. głębokość skrawania: 0,25 mm
Kąt natarcia: 0°, 6°, 12°

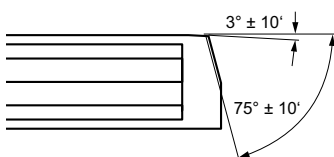

Nakrój AZ

Do dużych prędkości skrawania; szczególnie przydatny do obróbki aluminium.

Maks. głębokość skrawania: 0,5 mm
Kąt natarcia: 0°, 6°, 12°

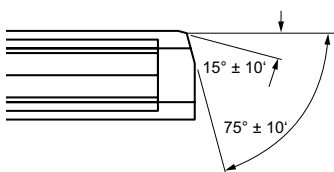

Nakrój DZ

Idealny do materiałów o krótkim skoku skrawania (żeliwo szare) i dużych głębokościach skrawania. Kąt nakroju ostrza wykańczającego 15° nieznacznie zwiększa siły promieniowe, dlatego jest przydatny do obróbki cienkościennych przedmiotów obrabianych.

Maks. głębokość skrawania: 0,15 mm
Kąt natarcia: 0°, 6°, 12°

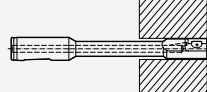
Narzędzie	Ostrze		Strona	Typoszereg
Typoszereg	Opis			
MN2000	Rozwiertak WP 		484	MN2000 Wersja z chwytem MK 
MN2003	Rozwiertak WP 		486	MN2003 Wersja krótka z chłodzeniem wewnętrznym 
MN2004			488	MN2004 Wersja krótka 
MN2034 (kształt krótki)			489	MN2034 Wersja bardzo krótka 
MN2023	Rozwiertak WP-NC 		490	MN2023 Konstrukcja NC 
MN2024			491	MN2024 Konstrukcja NC 
MN2043			492	MN2043 Konstrukcja NC 
MN2044			493	MN2044 Konstrukcja NC 

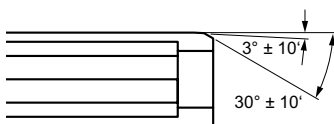

Nakrój EK

Stosować tylko wtedy, gdy wymagana jest mała długość nakroju 0,6 mm, do wszystkich materiałów obrabianych, nie przekraczać maks. prędkości posuwu 0,2 mm/obr.

Maks. głębokość skrawania: 0,15 mm
Kąt natarcia: 0°, 6°, 12°

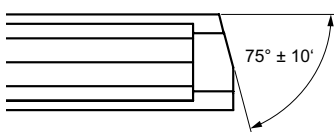

Nakrój SZ

Szczególnie przydatny do stopów aluminiowych, dobra jakość powierzchni przy małych posuwach. Dokładne dotrzymanie wymiarów skrawania. Kąt nakroju ostrza głównego 75° zmniejsza siły promieniowe, dlatego jest szczególnie przydatny do obróbki cienkościennych przedmiotów obrabianych.

Maks. głębokość skrawania: 1,0 mm
Kąt natarcia: 6°, 12°

Oznaczenia

Rozwiertak WP

M	N	2	0	0	0
---	---	---	---	---	---

Nazwa
Typoszereg

H	M
---	---

Jakość listwy prowadzącej

1	2
---	---

Średnica robocza

HM	Węglik spiekany
CT	Cermet

System EasyAdjust

E	A	S
---	---	---

Nazwa
(System EasyAdjust)
Typoszereg

R

Kierunek skrawania

R	W prawo
L	Lewo
N	neutralny

6	3
---	---

Ostrze

6	HX
4	TEC

M

Pochylenie

Wielkość systemu

GR	HX	TEC
2	Ø okregu wewnętrznego = 6	Ø okregu wewnętrznego = 6,35
3	Ø okregu wewnętrznego = 10	Ø okregu wewnętrznego = 9,525

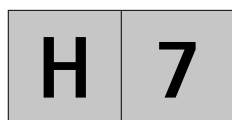

Tolerancja IT
lub wymiary

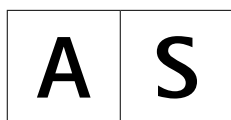

Symbol nakroju

AS	Informacje o zastosowaniu na stronach 478/479
AZ	
DZ	
EK	
SZ	

Oznaczenia

Płytki skrawające



Wielkość
81 | 90 | 91 | 92 | 93

Wybrać rozmiar odpowiedni do wersji rozwiertaka. Przy-
rządkowanie – patrz tabele produktów.

Podać tylko w przypadku wersji
z fazą F.

A S

9 2

R F 0

Typ nakroju
AS = 3°/30° długość 1,3 mm
AZ = 3°/75° długość 1,3 mm
DZ = 15°/75° długość 0,55 mm
EK = 3°/30° długość 0,6 mm
SZ = 0°/75° długość 0,55 mm

Kierunek skrawania
R = w prawo
L = w lewo

Wielkość kąta natarcia
0 = 0°
6 = 6°
2 = 12°

Płytki skrawające HX



H X

1

3

Nacięcie
8 = R 0,8

8

Kształt sześciokąt-
ny heksagonalny

Geometria kształtu wióra
(kąta natarcia)
1 = wysoki dodatni
2 = dodatni

Wielkość płytki skrawającej
2 = okrąg wewnętrzny \varnothing 6 mm
3 = okrąg wewnętrzny \varnothing 10 mm

Płytki skrawające TEC



T E C

2

0 8

F 0 1

Kształt czworokąt-
ny (tetragonalny)

Wielkość płytki skrawającej
2 = \varnothing okręgu wewnętrzne-
go: 6,35
3 = \varnothing okręgu wewnętrzne-
go: 9,525

Typ nakroju
04 = R = 0,4
08 = R = 0,8
AS = 3°/30° długość 1,3
EK = 3°/30° długość 0,6
DZ = 15°/75° długość 0,55

Wersja ostrza
F01 = bez promienia naroża
E02 = zaokrąglona
S35 = faza ujemna i zaokrąglona

H	U	6	1	5
---	---	---	---	---

Jakość materiału skrawającego
np.: HU = węgiel spiekany bez powłoki

R	L
---	---

Kierunek skrawania
RL = w prawo i w lewo

C	U	1	3	4
---	---	---	---	---

Jakość materiału skrawającego
np.: HU = węgiel spiekany bez powłoki

Opcja:
Faza F

R

Kierunek skrawania
R = w prawo
L = w lewo
N = w prawo/w lewo
(neutralny)

F

Zwijacz wiórow 1. pozycja (miejsce)
0 = nie określono
1 = równoległy dodatni

1	G
---	---

Zwijacz wiórow 2. pozycja (kąt natarcia)
A = 0° N = 12°
G = 6° U = 18°
J = 8°

F

Tylko w przypadku ostrzy z końcówkami
F = cała powierzchnia natarcia z jednej strony (pełna faza)

-	H	U	6	1	2
---	---	---	---	---	---

Jakość materiału skrawającego
(przykład)



Rozwiertak jednostrzowy WP MN2000

Wersja z chwytem MK

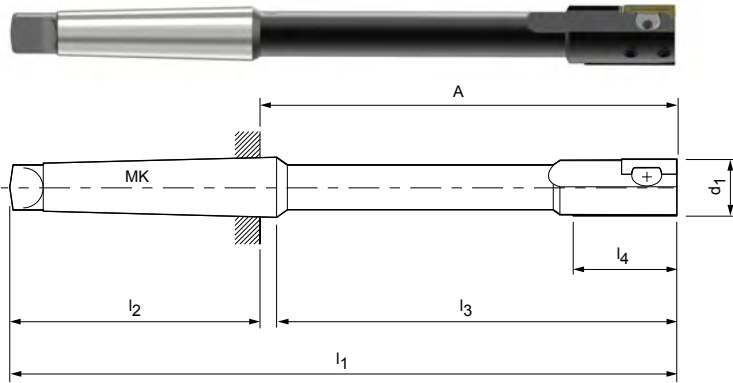

Wymiary							Wielkość płytki skrawającej	Osprzęt				
d ₁ *	l ₁	l ₂	l ₃	l ₄	MK	A		Technika mocowania		Regulacja		
								Śruba TORX®/wrzeciono gwintowane	Płytki mocująca	Trzpień gwintowany MN 620	Klin regulacyjny MN 619	
Nr materiałowy (wielkość)												
5,00 - 5,29	126**	62	60,5	15	1	64	(SP) 81	Śruba TORX®	10036776 (M1,6x3,9)	30026285 (GR - 1YN)	10036736 (M2x1,8)	30026239 (GR - 06)
5,30 - 5,49	126**	62	60,5	15	1	64	(SP) 81		10036778 (M1,6x4,4)	30026285 (GR - 1YN)	10036737 (M2x2)	30026239 (GR - 06)
5,50 - 6,19	126**	62	60,5	15	1	64	(SP) 81		10036780 (M2x4)	30026286 (GR - 1X)	10036737 (M2x2)	30026260 (GR - 07)
6,20 - 6,90	126**	62	60,5	15	1	64	(SP) 81		10036781 (M2x5)	30026286 (GR - 1X)	10036738 (M2x2,5)	30026260 (GR - 07)
6,91 - 7,49	136**	62	70,5	15	1	74	90		10036783 (M2,5x4,8)	30026287 (GR - 1W)	10036730 (M2,5x2,2)	30026261 (GR - 08)
7,50 - 7,79	136**	62	70,5	15	1	74	90		10036784 (M2,5x5,2)	30026287 (GR - 1W)	10036731 (M2,5x2,5)	30026262 (GR - 09)
7,80 - 7,99	155	62	89,5	30	1	93	90		10036711 (M3LH/RHx5)	30026288 (GR - 0F)	10036743 (M3x2,5)	30026238 (GR - 0)
8,00 - 8,79	155	62	89,5	30	1	93	90		10036711 (M3LH/RHx5)	30026288 (GR - 0F)	10036743 (M3x2,5)	30026238 (GR - 0)
8,80 - 9,29	160	62	94,5	30	1	98	90		10036722 (M3LH/RHx6)	30026289 (GR - 0N)	10036744 (M3x3)	30026238 (GR - 0)
9,30 - 9,79	170	62	104,5	30	1	108	91	10036722 (M3LH/RHx6)	30026292 (GR - 1N)	10036744 (M3x3)	30026238 (GR - 0)	
9,80 - 11,29	170	62	104,5	30	1	108	91	10036722 (M3LH/RHx6)	30026292 (GR - 1N)	10036744 (M3x3)	30026263 (GR - 1)	
11,30 - 11,79	170	62	104,5	30	1	108	92	10036724 (M4x0,5LH/RHx6,5)	30026294 (GR - 2F)	10036751 (M4x3)	30026266 (GR - 2)	
11,80 - 12,29	170	62	104,5	30	1	108	92	10036724 (M4x0,5LH/RHx6,5)	30026294 (GR - 2F)	10036751 (M4x3)	30026266 (GR - 2)	
12,30 - 13,29	180	62	114,5	30	1	118	92	10036724 (M4x0,5LH/RHx6,5)	30026294 (GR - 2F)	10036752 (M4x4)	30026266 (GR - 2)	
13,30 - 14,29	180	62	114,5	30	1	118	92	10036725 (M4x0,5LH/RHx9)	30026296 (GR - 2N)	10036753 (M4x5)	30026266 (GR - 2)	
14,30 - 15,29	180	62	114,5	30	1	118	92	10036725 (M4x0,5LH/RHx9)	30026296 (GR - 2N)	10036753 (M4x5)	30026266 (GR - 2)	
15,30 - 16,29	200	75	120	30	2	125	92	10036725 (M4x0,5LH/RHx9)	30026296 (GR - 2N)	10036753 (M4x5)	30026266 (GR - 2)	
16,30 - 18,29	210	75	130	30	2	135	92	10036725 (M4x0,5LH/RHx9)	30026296 (GR - 2N)	10036753 (M4x5)	30026266 (GR - 2)	
18,30 - 20,29	220	75	140	30	2	145	92	10036725 (M4x0,5LH/RHx9)	30026296 (GR - 2N)	10036755 (M4x8)	30026266 (GR - 2)	

Przykład zamówienia (patrz strona 480): MN2000 HM 11,8 H7 AS

Wymiary podano w mm.

Dalsze wymiary dostępne na zapytanie.

SP = płytki skrawające, nieprzeznaczona do obrabiania.

Instrukcje dotyczące regulacji i montażu akcesoriów – patrz rozdział „Aneks techniczny”.

* Wartości nie wskazują zakresu regulacji, tylko wielkości do różnych średnic (możliwość regulacji tylko w ramach zakresu tolerancji).

** Z czopem centrującym o długości 2,5 mm dla d₁ mniejszych niż 7,8 mm.

Przy składaniu zamówienia należy podać żadaną jakość listwy prowadzącej (węgiel spiekany, cermet).

Jeżeli informacja ta nie jest podana, listwy prowadzące są wykonane w jakości z węgla spiekanego.

Narzędzia z listwami prowadzącymi w jakości PCD dostępne od Ø 8 mm.

Naprawy z przyczyn technicznych możliwe od Ø 8,00

Informacje o cenach i terminach dostawy narzędzi z listwami prowadzącymi w jakości PCD dostępne na zapytanie.

Pasujące płytki skrawające od strony 494.

Rozwiertak jednostrzowy WP MN2003

Wersja krótka z chłodzeniem wewnętrznym

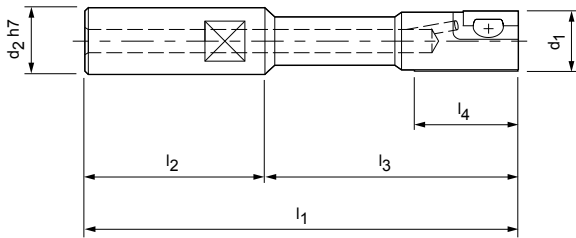

Wymiary						Wielkość płytki skrawa- jącej	Osprzęt				
d ₁ *	d ₂ H7	l ₁	l ₂	l ₃	l ₄		Technika mocowania		Regulacja		
							Śruba TORX®/wrzeciono gwintowane	Płytki mocująca	Trzpień gwintowany MN 620	Klin regulacyjny MN 619	
Nr materiały (wielkość)											
5,00 - 5,29	10	90**	30	60	15	(SP) 81	Śruba TORX®	10036776 (M1,6x3,9)	30026285 (GR - 1YN)	10036736 (M2x1,8)	30026239 (GR - 06)
5,30 - 5,49	10	90**	30	60	15	(SP) 81		10036778 (M1,6x4,4)	30026285 (GR - 1YN)	10036737 (M2x2)	30026239 (GR - 06)
5,50 - 6,19	10	90**	30	60	15	(SP) 81		10036780 (M2x4)	30026286 (GR - 1X)	10036737 (M2x2)	30026260 (GR - 07)
6,20 - 6,90	10	90**	30	60	15	(SP) 81		10036781 (M2x5)	30026286 (GR - 1X)	10036738 (M2x2,5)	30026260 (GR - 07)
6,91 - 7,49	10	100**	30	70	15	90		10036783 (M2,5x4,8)	30026287 (GR - 1W)	10036730 (M2,5x2,2)	30026261 (GR - 08)
7,50 - 7,79	10	100**	30	70	15	90		10036784 (M2,5x5,2)	30026287 (GR - 1W)	10036731 (M2,5x2,5)	30026262 (GR - 09)
7,80 - 8,29	16	120	45	75	30	90		10036711 (M3LH/RHx5)	30026288 (GR - 0F)	10036743 (M3x2,5)	30026238 (GR - 0)
8,30 - 8,79	16	120	45	75	30	90		10036711 (M3LH/RHx5)	30026288 (GR - 0F)	10036744 (M3x3)	30026238 (GR - 0)
8,80 - 9,29	16	120	45	75	30	90		10036722 (M3LH/RHx6)	30026289 (GR - 0N)	10036744 (M3x3)	30026238 (GR - 0)
9,30 - 9,79	16	120	45	75	30	91		10036722 (M3LH/RHx6)	30026292 (GR - 1N)	10036744 (M3x3)	30026238 (GR - 0)
9,80 - 11,29	16	120	45	75	30	91		10036722 (M3LH/RHx6)	30026292 (GR - 1N)	10036744 (M3x3)	30026263 (GR - 1)
11,30 - 11,79	16	120	45	75	30	92		10036724 (M4x0,5LH/RHx6,5)	30026294 (GR - 2F)	10036751 (M4x3)	30026266 (GR - 2)
11,80 - 12,29	16	120	45	75	30	92		10036724 (M4x0,5LH/RHx6,5)	30026294 (GR - 2F)	10036751 (M4x3)	30026266 (GR - 2)
12,30 - 13,29	16	120	45	75	30	92		10036724 (M4x0,5LH/RHx6,5)	30026294 (GR - 2F)	10036752 (M4x4)	30026266 (GR - 2)
13,30 - 14,29	16	120	45	75	30	92		10036725 (M4x0,5LH/RHx9)	30026296 (GR - 2N)	10036753 (M4x8)	30026266 (GR - 2)
14,30 - 18,29	20	130	55	75	30	92		10036725 (M4x0,5LH/RHx9)	30026296 (GR - 2N)	10036753 (M4x8)	30026266 (GR - 2)
18,30 - 19,79	20	130	55	75	30	92	10036725 (M4x0,5LH/RHx9)	30026296 (GR - 3N)	10036755 (M6x15)	30026266 (GR - 4)	
19,80 - 20,29	20	150	55	95	30	92	10036725 (M4x0,5LH/RHx9)	30026296 (GR - 3N)	10036755 (M6x15)	30026266 (GR - 4)	

Rozwiertak jednostrzowy WP MN2003

Wymiary						Wielkość płytki skrawa- jącej	Osprzęt				
d ₁ *	d ₂ H7	l ₁	l ₂	l ₃	l ₄		Technika mocowania		Regulacja		
							Śruba TORX®/wrzeciono gwintowane	Płytką mocującą	Trzpień gwintowany MN 620	Klin regulacyjny MN 619	
											Nr materiałowy (wielkość)
20,30 – 26,29	20	150	55	95	30	92	MN 618	10036725 (M4x0,5LH/RHx9)	30026296 (GR - 2N)	10036755 (M4x8)	30026266 (GR - 2)
26,30 – 30,29	25	160	65	95	30	92		10036725 (M4x0,5LH/RHx9)	30026296 (GR - 2N)	10036755 (M4x8)	30026266 (GR - 2)

Przykład zamówienia (patrz strona 480):
MN2003 HM 20,99 H7 AS

Wymiary podano w mm.

Dalsze wymiary dostępne na zapytanie.

SP = płytka skrawająca, nieprzeznaczona do obracania.

Instrukcje dotyczące regulacji i montażu akcesoriów – patrz rozdział „Aneks techniczny”.

* Wartości nie wskazują zakresu regulacji, tylko wielkości do różnych średnic (możliwość regulacji tylko w ramach zakresu tolerancji).

** Z czopem centrującym o długości 2,5 mm dla d₁ mniejszych niż 7,8 mm.

Przy składaniu zamówienia należy podać żądaną jakość listwy prowadzącej (węgiel spiekany, cermet).

Jeżeli informacja ta nie jest podana, listwy prowadzące są wykonane w jakości z węgla spiekanego.

Narzędzia z listwami prowadzącymi w jakości PCD dostępne od Ø 8 mm.

Naprawy z przyczyn technicznych możliwe od Ø 8.00

Informacje o cenach i terminach dostawy narzędzi z listwami prowadzącymi w jakości PCD dostępne na zapytanie.

Pasujące płytki skrawające od strony 494.

Rozwiertak jednostrzowy WP MN2004

Wersja krótka

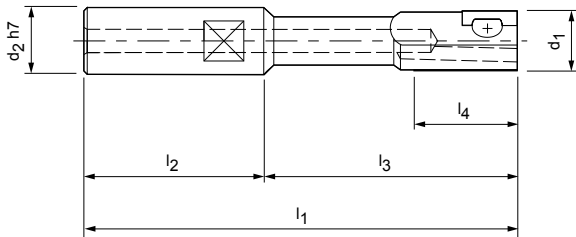

Wymiary						Wielkość płytki skrawa- jącej	Osprzęt				
d ₁ *	d ₂ H7	l ₁	l ₂	l ₃	l ₄		Technika mocowania		Regulacja		
							Śruba TORX®/wrzeciono gwintowane	Płytki mocująca	Trzpień gwintowany MN 620	Klin regulacyjny MN 619	
Nr materiały (wielkość)											
5,90 - 6,29	10	90**	30	60	15	(SP) 81	Śruba TORX®	10036776 (M1,6x3,9)	30026285 (GR - 1YN)	10036737 (M2x2)	30026239 (GR - 06)
6,30 - 6,90	10	90**	30	60	15	(SP) 81		10036778 (M1,6x4,4)	30026285 (GR - 1YN)	10036738 (M2x2,5)	30026239 (GR - 06)
6,91 - 7,29	10	100**	30	70	15	(SP) 81		10036778 (M1,6x4,4)	30026285 (GR - 1YN)	10036738 (M2x2,5)	30026239 (GR - 06)
7,30 - 7,79	10	100**	30	70	15	(SP) 81		10036781 (M2x5)	30026286 (GR - 1X)	10036739 (M2x3)	30026260 (GR - 07)
7,80 - 8,29	16	120**	45	75	15	(SP) 81		10036781 (M2x5)	30026286 (GR - 1X)	10036739 (M2x3)	30026260 (GR - 07)
8,30 - 9,79	16	120	45	75	15	90		10036784 (M2,5x5,2)	30026287 (GR - 1W)	10036732 (M2,5x3)	30026262 (GR - 09)
9,80 - 10,29	16	120	45	75	15	90		10036784 (M2,5x5,2)	30026287 (GR - 1W)	10036733 (M2,5x4)	30026262 (GR - 09)
10,30 - 11,29	16	120	45	75	30	90		10036722 (M3LH/RHx6)	30026289 (GR - 0N)	10036744 (M3x3)	30026263 (GR - 1)
11,30 - 12,29	16	120	45	75	30	90		10036722 (M3LH/RHx6)	30026289 (GR - 0N)	10036745 (M3x4)	30026263 (GR - 1)
12,30 - 14,29	16	120	45	75	30	91		10036722 (M3LH/RHx6)	30026292 (GR - 1N)	10036745 (M3x4)	30026263 (GR - 1)
14,30 - 16,29	20	130	55	75	30	91	10036722 (M3LH/RHx6)	30026292 (GR - 1N)	10036747 (M3x6)	30026263 (GR - 1)	
16,30 - 17,29	20	130	55	75	30	92	10036725 (M4x0,5LH/RHx9)	30026296 (GR - 2N)	10036753 (M4x5)	30026266 (GR - 2)	
17,30 - 19,79	20	130	55	75	30	92	10036725 (M4x0,5LH/RHx9)	30026296 (GR - 2N)	10036754 (M4x6)	30026266 (GR - 2)	
19,80 - 26,29	20	150	55	95	30	92	10036725 (M4x0,5LH/RHx9)	30026296 (GR - 2N)	10036755 (M4x8)	30026266 (GR - 2)	
26,30 - 30,29	25	160	65	95	30	92	10036725 (M4x0,5LH/RHx9)	30026296 (GR - 2N)	10036755 (M4x8)	30026266 (GR - 2)	

Przykład zamówienia (patrz strona 480):

MN2004 HM 20,99 H7 AS

Wymiary podano w mm.

Dalsze wymiary dostępne na zapytanie.

Instrukcje dotyczące regulacji i montażu akcesoriów – patrz rozdział „Aneks techniczny”.

* Wartości nie wskazują zakresu regulacji, tylko wielkości do różnych średnic (możliwość regulacji tylko w ramach zakresu tolerancji).

** Z czopem centrującym o długości 1 mm dla d₁ mniejszych niż 8,3 mm.

Przy składaniu zamówienia należy podać żadaną jakość listwy prowadzącej (węgiel spiekany, cermet).

Jeżeli informacja ta nie jest podana, listwy prowadzące są wykonane w jakości z węgla spiekanego.

Narzędzia z listwami prowadzącymi w jakości PCD dostępne od Ø 8 mm.

Naprawy z przyczyn technicznych możliwe od Ø 8,00

Informacje o cenach i terminach dostawy narzędzi z listwami prowadzącymi w jakości PCD dostępne na zapytanie.

Pasujące płytki skrawające od strony 494.

Rozwiertak jednostrzowy WP MN2034

Wersja bardzo krótka

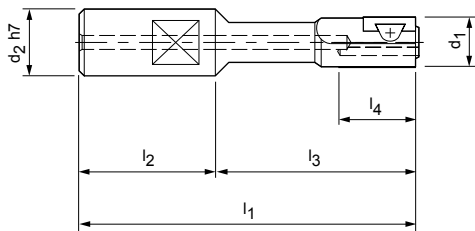

Wymiary						Wielkość płytki skrawa- jącej	Osprzęt					
d ₁ *	d ₂ H7	l ₁	l ₂	l ₃	l ₄		Technika mocowania		Regulacja			
							Śruba TORX®/wrzeciono gwintowane	Płytki mocująca	Trzpień gwintowany MN 620	Klin regulacyjny MN 619		
Nr materiały (wielkość)												
5,90 - 6,29	16	85**	27	58	15	(SP) 81	Śruba TORX®	10036776 (M1,6x3,9)	30026285 (GR - 1YN)	10036737 (M2x2)	30026239 (GR - 06)	
6,30 - 7,29	16	85**	27	58	15	(SP) 81		10036778 (M1,6x4,4)	30026285 (GR - 1YN)	10036738 (M2x2,5)	30026239 (GR - 06)	
7,30 - 8,29	16	85**	27	58	15	(SP) 81		10036781 (M2x5)	30026286 (GR - 1X)	10036739 (M2x3)	30026260 (GR - 07)	
8,30 - 9,79	16	85	27	58	15	90		10036784 (M2,5x5,2)	30026287 (GR - 1W)	10036732 (M2,5x3)	30026262 (GR - 09)	
9,80 - 10,29	16	85	27	58	15	90		10036784 (M2,5x5,2)	30026287 (GR - 1W)	10036733 (M2,5x4)	30026262 (GR - 09)	
10,30 - 11,29	16	85	27	58	30	90		Wrzeciono gwintowane MN 618	10036722 (M3LH/RHx6)	30026289 (GR - 0N)	10036744 (M3x3)	30026263 (GR - 1)
11,30 - 12,29	16	85	27	58	30	90			10036722 (M3LH/RHx6)	30026289 (GR - 0N)	10036745 (M3x4)	30026263 (GR - 1)
12,30 - 14,29	16	85	27	58	30	91			10036722 (M3LH/RHx6)	30026292 (GR - 1N)	10036745 (M3x4)	30026263 (GR - 1)
14,30 - 16,29	16	85	27	58	30	91			10036722 (M3LH/RHx6)	30026292 (GR - 1N)	10036747 (M3x6)	30026263 (GR - 1)
16,30 - 17,29	16	85	27	58	30	92			10036725 (M4x0,5LH/RHx9)	30026296 (GR - 2N)	10036753 (M4x5)	30026266 (GR - 2)
17,30 - 19,79	16	85	27	58	30	92	10036725 (M4x0,5LH/RHx9)		30026296 (GR - 2N)	10036754 (M4x6)	30026266 (GR - 2)	
19,80 - 20,29	16	85	27	58	30	92	10036725 (M4x0,5LH/RHx9)		30026296 (GR - 2N)	10036755 (M4x8)	30026266 (GR - 2)	
20,30 - 26,30	20	90	30	60	30	92	10036725 (M4x0,5LH/RHx9)		30026296 (GR - 2N)	10036755 (M4x8)	30026266 (GR - 2)	
26,30 - 30,29	25	90	30	60	30	92	10036725 (M4x0,5LH/RHx9)		30026296 (GR - 2N)	10036755 (M4x8)	30026266 (GR - 2)	

Przykład zamówienia (patrz strona 480):
MN2034 HM 20,99 H7 AS

Wymiary podano w mm.

Dalsze wymiary dostępne na zapytanie.

SP = płytki skrawające, nieprzeznaczona do obrabiania.

Instrukcje dotyczące regulacji i montażu akcesoriów – patrz rozdział „Aneks techniczny”.

* Wartości nie wskazują zakresu regulacji, tylko wielkości do różnych średnic (możliwość regulacji tylko w ramach zakresu tolerancji).

** Z czopem centrującym o długości 1 mm dla d₁ mniejszych niż 8,3 mm.

Przy składaniu zamówienia należy podać żadaną jakość listwy prowadzącej (węgiel spiekany, cermet).

Jeżeli informacja ta nie jest podana, listwy prowadzące są wykonane w jakości z węgla spiekanego.

Narzędzia z listwami prowadzącymi w jakości PCD dostępne od Ø 8 mm.

Naprawy z przyczyn technicznych możliwe od Ø 8.00

Informacje o cenach i terminach dostawy narzędzi z listwami prowadzącymi w jakości PCD dostępne na zapytanie.

Pasujące płytki skrawające od strony 494.

Rozwiertak jednostrzowy WP MN2023

Wersja NC

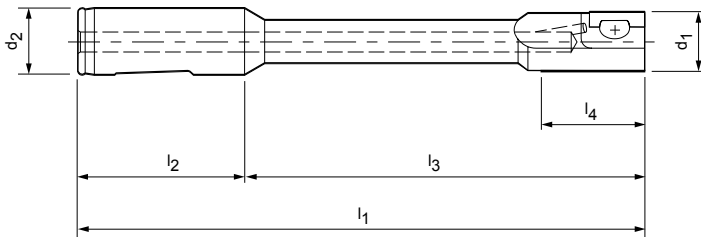

Wymiary							Osprzęt			
d ₁ *	d ₂ (-0,003)	l ₁	l ₂	l ₃	l ₄	Wielkość płytki skrawającej	Technika mocowania		Regulacja	
							Wrzeciono gwintowane MN 618	Płytką mocującą	Trzpień gwintowany MN 620	Klin regulacyjny MN 619
Nr materiały (wielkość)										
7,80 - 8,29	16	133	48	85	30	90	10036711 (M3LH/RHx5)	30026288 (GR - 0F)	10036743 (M3x2,5)	30026238 (GR - 0)
8,30 - 8,79	16	133	48	85	30	90	10036711 (M3LH/RHx5)	30026288 (GR - 0F)	10036744 (M3x3)	30026238 (GR - 0)
8,80 - 9,29	16	133	48	85	30	90	10036711 (M3LH/RHx5)	30026289 (GR - 0N)	10036744 (M3x3)	30026238 (GR - 0)
9,30 - 11,29	16	133	48	85	30	91	10036722 (M3LH/RHx6)	30026292 (GR - 1N)	10036744 (M3x3)	30026263 (GR - 1)
11,30 - 11,79	16	133	48	85	30	92	10036724 (M4x0,5LH/RHx6,5)	30026294 (GR - 2F)	10036751 (M4x3)	30026266 (GR - 2)
11,80 - 12,29	16	168	48	120	30	92	10036724 (M4x0,5LH/RHx6,5)	30026294 (GR - 2F)	10036751 (M4x3)	30026266 (GR - 2)
12,30 - 13,29	16	168	48	120	30	92	10036724 (M4x0,5LH/RHx6,5)	30026294 (GR - 2F)	10036752 (M4x4)	30026266 (GR - 2)
13,30 - 14,29	16	168	48	120	30	92	10036725 (M4x0,5LH/RHx9)	30026296 (GR - 2N)	10036753 (M4x5)	30026266 (GR - 2)
14,30 - 15,79	20	170	50	120	30	92	10036725 (M4x0,5LH/RHx9)	30026296 (GR - 2N)	10036753 (M4x5)	30026266 (GR - 2)
15,80 - 17,79	20	170	50	120	30	92	10036725 (M4x0,5LH/RHx9)	30026296 (GR - 2N)	10036753 (M4x5)	30026266 (GR - 2)
17,80 - 18,29	20	170	50	120	30	92	10036725 (M4x0,5LH/RHx9)	30026296 (GR - 2N)	10036753 (M4x5)	30026266 (GR - 2)
18,30 - 19,79	20	170	50	120	30	92	10036725 (M4x0,5LH/RHx9)	30026296 (GR - 2N)	10036754 (M4x6)	30026266 (GR - 2)
19,80 - 24,79	20	170	50	120	30	92	10036725 (M4x0,5LH/RHx9)	30026296 (GR - 2N)	10036755 (M4x8)	30026266 (GR - 2)
24,80 - 29,29	20	170	50	120	30	93	10036725 (M4x0,5LH/RHx9)	30026298 (GR - 3N)	10036761 (M6x10)	30026279 (GR - 4)
28,80 - 30,79	20	170	50	120	30	93	10036725 (M4x0,5LH/RHx9)	30026298 (GR - 3N)	10036762 (M6x12)	30026279 (GR - 4)

Przykład zamówienia (patrz strona 480):

MN2023 HM 20,99 H7 AS

Wymiary podano w mm.

Dalsze wymiary dostępne na zapytanie.

Instrukcje dotyczące regulacji i montażu akcesoriów – patrz rozdział „Aneks techniczny”.

* Wartości nie wskazują zakresu regulacji, tylko wielkości do różnych średnic (możliwość regulacji tylko w ramach zakresu tolerancji).

Przy składaniu zamówienia należy podać żądaną jakość listwy prowadzącej (węgiel spiekany, cermet).

Jeżeli informacja ta nie jest podana, listwy prowadzące są wykonane w jakości z węgla spiekanego.

Narzędzia z listwami prowadzącymi w jakości PCD dostępne od Ø 8 mm.

Naprawy z przyczyn technicznych możliwe od Ø 8,00

Informacje o cenach i terminach dostawy narzędzi z listwami prowadzącymi w jakości PCD dostępne na zapytanie.

Pasujące płytki skrawające od strony 494.

Rozwiertak jednostrzowy WP MN2024

Wersja NC

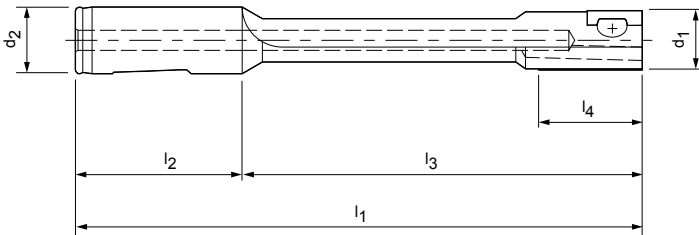

Wymiary							Osprzęt			
d ₁ *	d ₂ (-0,003)	l ₁	l ₂	l ₃	l ₄	Wielkość płytki skrawającej	Technika mocowania		Regulacja	
							Wrzeczono gwintowane MN 618	Płytką mocującą	Trzpień gwintowany MN 620	Klin regulacyjny MN 619
7,80 - 8,29	16	133	48	85	30	90	10036711 (M3LH/RHx5)	30026291 (GR - OZ)	10036743 (M3x2,5)	30026238 (GR - 0)
8,30 - 8,79	16	133	48	85	30	90	10036711 (M3LH/RHx5)	30026291 (GR - OZ)	10036744 (M3x3)	30026238 (GR - 0)
8,80 - 9,29	16	133	48	85	30	90	10036711 (M3LH/RHx5)	30026291 (GR - OZ)	10036744 (M3x3)	30026238 (GR - 0)
9,30 - 11,29	16	133	48	85	30	90	10036722 (M3LH/RHx6)	30026289 (GR - ON)	10036744 (M3x3)	30026263 (GR - 1)
11,30 - 11,79	16	133	48	85	30	90	10036722 (M3LH/RHx6)	30026289 (GR - ON)	10036745 (M3x4)	30026263 (GR - 1)
11,80 - 12,29	16	168	48	120	30	90	10036722 (M3LH/RHx6)	30026289 (GR - ON)	10036745 (M3x4)	30026263 (GR - 1)
12,30 - 14,29	16	168	48	120	30	91	10036722 (M3LH/RHx6)	30026292 (GR - 1N)	10036745 (M3x4)	30026263 (GR - 1)
14,30 - 16,29	20	170	50	120	30	91	10036722 (M3LH/RHx6)	30026292 (GR - 1N)	10036747 (M3x6)	30026263 (GR - 1)
16,30 - 17,29	20	170	50	120	30	92	10036725 (M4x0,5LH/RHx9)	30026296 (GR - 2N)	10036753 (M4x5)	30026266 (GR - 2)
17,30 - 19,79	20	170	50	120	30	92	10036725 (M4x0,5LH/RHx9)	30026296 (GR - 2N)	10036754 (M4x6)	30026266 (GR - 2)
19,80 - 20,79	20	170	50	120	30	92	10036725 (M4x0,5LH/RHx9)	30026296 (GR - 2N)	10036755 (M4x8)	30026266 (GR - 2)

Przykład zamówienia (patrz strona 480):
MN2024 HM 11,99 H7 AS

Wymiary podano w mm.

Dalsze wymiary dostępne na zapytanie.

Instrukcje dotyczące regulacji i montażu akcesoriów – patrz rozdział „Aneks techniczny”.

* Wartości nie wskazują zakresu regulacji, tylko wielkości do różnych średnic (możliwość regulacji tylko w ramach zakresu tolerancji).

Przy składaniu zamówienia należy podać żądaną jakość listwy prowadzącej (węgiel spiekany, cermet).

Jeżeli informacja ta nie jest podana, listwy prowadzące są wykonane w jakości z węgla spiekanego.

Narzędzia z listwami prowadzącymi w jakości PCD dostępne od Ø 8 mm.

Naprawy z przyczyn technicznych możliwe od Ø 8,00

Informacje o cenach i terminach dostawy narzędzi z listwami prowadzącymi w jakości PCD dostępne na zapytanie.

Pasujące płytki skrawające od strony 494.

Rozwiertak jednostrzowy WP MN2043

Wersja NC

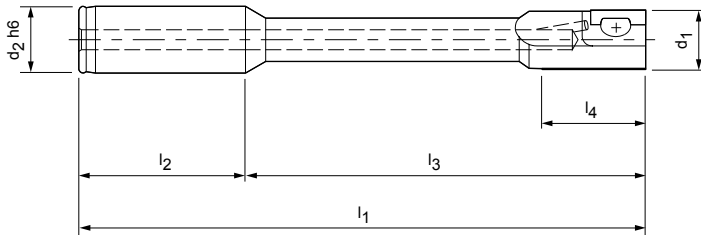

Wymiary							Osprzęt			
d ₁ *	d ₂ h6	l ₁	l ₂	l ₃	l ₄	Wielkość płytki skrawającej	Technika mocowania		Regulacja	
							Wrzeciono gwintowane MN 618	Płytki mocująca	Trzpień gwintowany MN 620	Klin regulacyjny MN 619
Nr materiały (wielkość)										
7,80 - 8,29	16	133	48	85	30	90	10036711 (M3LH/RHx5)	30026288 (GR - 0F)	10036743 (M3x2,5)	30026238 (GR - 0)
8,30 - 8,79	16	133	48	85	30	90	10036711 (M3LH/RHx5)	30026288 (GR - 0F)	10036744 (M3x3)	30026238 (GR - 0)
8,80 - 9,29	16	133	48	85	30	90	10036711 (M3LH/RHx5)	30026289 (GR - 0N)	10036744 (M3x3)	30026238 (GR - 0)
9,30 - 11,29	16	133	48	85	30	91	10036722 (M3LH/RHx6)	30026292 (GR - 1N)	10036744 (M3x3)	30026263 (GR - 1)
11,30 - 11,79	16	133	48	85	30	92	10036724 (M4x0,5LH/RHx6,5)	30026294 (GR - 2F)	10036751 (M4x3)	30026266 (GR - 2)
11,80 - 12,29	16	168	48	120	30	92	10036724 (M4x0,5LH/RHx6,5)	30026294 (GR - 2F)	10036751 (M4x3)	30026266 (GR - 2)
12,30 - 13,29	16	168	48	120	30	92	10036724 (M4x0,5LH/RHx6,5)	30026294 (GR - 2F)	10036752 (M4x4)	30026266 (GR - 2)
13,30 - 14,29	16	168	48	120	30	92	10036725 (M4x0,5LH/RHx9)	30026296 (GR - 2N)	10036753 (M4x5)	30026266 (GR - 2)
14,30 - 15,79	20	170	50	120	30	92	10036725 (M4x0,5LH/RHx9)	30026296 (GR - 2N)	10036753 (M4x5)	30026266 (GR - 2)
15,80 - 17,79	20	170	50	120	30	92	10036725 (M4x0,5LH/RHx9)	30026296 (GR - 2N)	10036753 (M4x5)	30026266 (GR - 2)
17,80 - 18,29	20	170	50	120	30	92	10036725 (M4x0,5LH/RHx9)	30026296 (GR - 2N)	10036753 (M4x5)	30026266 (GR - 2)
18,30 - 19,79	20	170	50	120	30	92	10036725 (M4x0,5LH/RHx9)	30026296 (GR - 2N)	10036754 (M4x6)	30026266 (GR - 2)
19,80 - 24,79	20	170	50	120	30	92	10036725 (M4x0,5LH/RHx9)	30026296 (GR - 2N)	10036755 (M4x8)	30026266 (GR - 2)
24,80 - 28,79	20	170	50	120	30	93	10036725 (M4x0,5LH/RHx9)	30026298 (GR - 3N)	10036761 (M6x10)	30026279 (GR - 4)
28,80 - 31,79	20	170	50	120	30	93	10036725 (M4x0,5LH/RHx9)	30026298 (GR - 3N)	10036762 (M6x12)	30026279 (GR - 4)
31,80 - 37,79	20	170	50	120	30	93	10036725 (M4x0,5LH/RHx9)	30026298 (GR - 3N)	10036764 (M6x15)	30026279 (GR - 4)
37,80 - 40,29	25	176	56	120	30	93	10036725 (M4x0,5LH/RHx9)	30026298 (GR - 3N)	10036764 (M6x15)	30026279 (GR - 4)

Przykład zamówienia (patrz strona 480):

MN2043 HM 20,99 H7 AS

Wymiary podano w mm.

Dalsze wymiary dostępne na zapytanie.

Instrukcje dotyczące regulacji i montażu akcesoriów – patrz rozdział „Aneks techniczny”.

* Wartości nie wskazują zakresu regulacji, tylko wielkości do różnych średnic (możliwość regulacji tylko w ramach zakresu tolerancji).

Przy składaniu zamówienia należy podać żądaną jakość listwy prowadzącej (węgiel spiekany, cermet).

Jeżeli informacja ta nie jest podana, listwy prowadzące są wykonane w jakości z węgla spiekanego.

Narzędzia z listwami prowadzącymi w jakości PCD dostępne od Ø 8 mm.

Naprawy z przyczyn technicznych możliwe od Ø 8,00

Informacje o cenach i terminach dostawy narzędzi z listwami prowadzącymi w jakości PCD dostępne na zapytanie.

Pasujące płytki skrawające od strony 494.

Rozwiertak jednostrzowy WP MN2044

Wersja NC

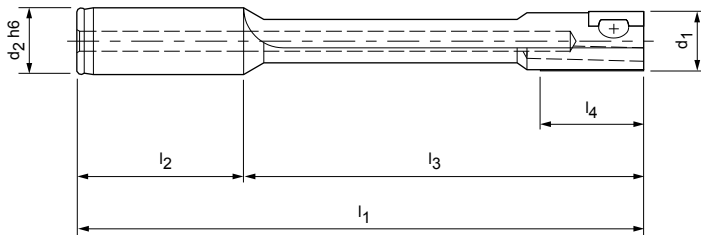

Wymiary							Osprzęt			
d ₁ *	d ₂ h6	l ₁	l ₂	l ₃	l ₄	Wielkość płytki skrawającej	Technika mocowania		Regulacja	
							Wrzeczono gwintowane MN 618	Płytką mocującą	Trzpień gwintowany MN 620	Klin regulacyjny MN 619
Nr materiały (wielkość)										
7,80 - 8,29	16	133	48	85	30	90	10036711 (M3LH/RHx5)	30026291 (GR - OZ)	10036743 (M3x2,5)	30026238 (GR - 0)
8,30 - 8,79	16	133	48	85	30	90	10036711 (M3LH/RHx5)	30026291 (GR - OZ)	10036744 (M3x3)	30026238 (GR - 0)
8,80 - 9,29	16	133	48	85	30	90	10036711 (M3LH/RHx5)	30026291 (GR - OZ)	10036744 (M3x3)	30026238 (GR - 0)
9,30 - 11,29	16	133	48	85	30	90	10036722 (M3LH/RHx6)	30026289 (GR - ON)	10036744 (M3x3)	30026263 (GR - 1)
11,30 - 11,79	16	133	48	85	30	90	10036722 (M3LH/RHx6)	30026289 (GR - ON)	10036745 (M3x4)	30026263 (GR - 1)
11,80 - 12,29	16	168	48	120	30	90	10036722 (M3LH/RHx6)	30026289 (GR - ON)	10036745 (M3x4)	30026263 (GR - 1)
12,30 - 14,29	16	168	48	120	30	91	10036722 (M3LH/RHx6)	30026292 (GR - 1N)	10036745 (M3x4)	30026263 (GR - 1)
14,30 - 16,29	20	170	50	120	30	91	10036722 (M3LH/RHx6)	30026292 (GR - 1N)	10036747 (M3x6)	30026263 (GR - 1)
16,30 - 17,29	20	170	50	120	30	92	10036725 (M4x0,5LH/RHx9)	30026296 (GR - 2N)	10036753 (M4x5)	30026266 (GR - 2)
17,30 - 19,79	20	170	50	120	30	92	10036725 (M4x0,5LH/RHx9)	30026296 (GR - 2N)	10036754 (M4x6)	30026266 (GR - 2)
19,80 - 20,79	20	170	50	120	30	92	10036725 (M4x0,5LH/RHx9)	30026296 (GR - 2N)	10036755 (M4x8)	30026266 (GR - 2)

Przykład zamówienia (patrz strona 480):

MN2044 HM 11,99 H7 AS

Wymiary podano w mm.

Dalsze wymiary dostępne na zapytanie.

Instrukcje dotyczące regulacji i montażu akcesoriów – patrz rozdział „Aneks techniczny”.

* Wartości nie wskazują zakresu regulacji, tylko wielkości do różnych średnic (możliwość regulacji tylko w ramach zakresu tolerancji).

Przy składaniu zamówienia należy podać żądaną jakość listwy prowadzącej (węgiel spiekany, cermet).

Jeżeli informacja ta nie jest podana, listwy prowadzące są wykonane w jakości z węgla spiekanego.

Narzędzia z listwami prowadzącymi w jakości PCD dostępne od Ø 8 mm.

Naprawy z przyczyn technicznych możliwe od Ø 8,00

Informacje o cenach i terminach dostawy narzędzi z listwami prowadzącymi w jakości PCD dostępne na zapytanie.

Pasujące płytki skrawające od strony 494.

Płytki skrawające z nakrojem AS

Do narzędzi z listwami prowadzącymi

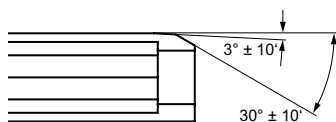

Nakrój AS

Nakrój odpowiedni do wszystkich materiałów, wysoka jakość powierzchni nawet przy dużych prędkościach skrawania. Długość nakroju 1,3 mm.

Maks. głębokość skrawania: 0,25 mm
Kąt natarcia: 0°, 6°, 12°

Materiał skrawający	Węgiel spiekany								
	P			M	K		N		
MZG*	1.1 - 1.2	2 - 3 5	P4 P6	1 - 3	1.1	2 - 3	1.1 - 1.2	2.3	2.1 - 2.2
Rodzaj materiału skrawającego	HP115	HP425	HP016	HP016	HC418	HP426	HP612	HU615	

Kąt natarcia	Wielkość	Specyfikacja	Nr materiałowy							
ujemny	81	SP-AS81R0-...								
	90	SP-AS90R0-...								
	91	SP-AS91R0-...								
	92	SP-AS92R0-...								
	93	SP-AS93R0-...								

neutralny	81	SP-AS81R0-...								
	90	WP-AS90R0-...								
	91	WP-AS91R0-...								
	92	WP-AS92R0-...								
	93	WP-AS93R0-...								

dodatni	81	SP-AS81R6-...	30669442	30669444	31100866	31100866				30669441	
	90	WP-AS90R6-...	30668837	30668839	31100867	31100867				30668836	
	91	WP-AS91R6-...	30668848	30668850	31080268	31080268				30668847	
	92	WP-AS92R6-...	30668858	30668859	30912087	30912087				30668857	
	93	WP-AS93R6-...	30668869	30250310	30915826	30915826				30668868	

wysoki dodatni	81	SP-AS81R2-...								30685605		30669437
	90	WP-AS90R2-...								30685606		30668833
	91	WP-AS91R2-...								30685607		30668844
	92	WP-AS92R2-...								30685608		30668853
	93	WP-AS93R2-...								30685609		30668863

* Grupa materiałowa wg MAPAL

Płytki skrawające z nakrojem AZ

Do narzędzi z listwami prowadzącymi

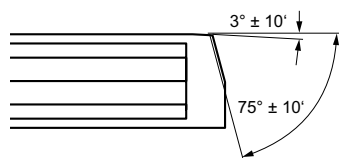

Nakrój AZ

Do dużych prędkości skrawania; szczególnie przydatny do obróbki aluminium.

Maks. głębokość skrawania: 0,5 mm
Kąt natarcia: 0°, 6°, 12°

Materiał skrawający	Węglik spiekany									
	P			M	K			N		
MZG*	1.1 - 1.2	2 - 3 5	4 6	1 - 3	1.1	2 - 3	1.1 - 1.2	2.3	2.1 - 2.2	
Rodzaj materiału skrawającego	HP115	HP425	HP016	HP016	HC418	HP426	HP612	HU615		

Kąt natarcia	Wielkość	Specyfikacja	Nr materiałowy								
ujemny	81	SP-AZ81R0-...									
	90	SP-AZ90R0-...									
	91	SP-AZ91R0-...									
	92	SP-AZ92R0-...									
	93	SP-AZ93R0-...									

neutralny	81	SP-AZ81R0-...					30685624				
	90	WP-AZ90R0-...					30670062				
	91	WP-AZ91R0-...					30685625				
	92	WP-AZ92R0-...					30664930				
	93	WP-AZ93R0-...					30664935				

dodatni	81	SP-AZ81R6-...						30914241		30668876	
	90	WP-AZ90R6-...						30914251		30668884	
	91	WP-AZ91R6-...						30914261		30668891	
	92	WP-AZ92R6-...						30914275		30668903	
	93	WP-AZ93R6-...						30914304		30668912	

wysoki dodatni	81	SP-AZ81R2-...							30685639		30668875
	90	WP-AZ90R2-...							30685640		30668881
	91	WP-AZ91R2-...							30685641		30668889
	92	WP-AZ92R2-...							30685642		30668899
	93	WP-AZ93R2-...							30685643		30668908

* Grupa materiałowa wg MAPAL

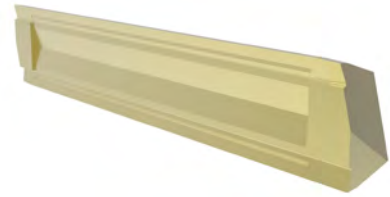

Węglik spiekany		Cermet		PCD		PcBN	
S	H	P	N	K	H		
1 - 2	1.1	1 - 3 5	1 - 2	1.1	1.1 - 1.2		
HU615	HP016	CP122	PU620	FU485	FU801		
Nr materiałowy		Nr materiałowy		Nr materiałowy		Nr materiałowy	
						30685648**	
						30685649**	
						30685650**	
						30530294**	
				30669205**			
				30669207**			
				30669210**			
				30669215**			
				30669218**			

Zalecane parametry skrawania - patrz koniec rozdziału.
 Ostrza z nakrojem specjalnym dostępne na zapytanie.

Płytki skrawające z nakrojem DZ

Do narzędzi z listwami prowadzącymi

Nakrój DZ

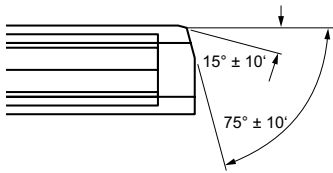

Idealny do materiałów o krótkim skoku skrawania (żeliwo szare) i dużych głębokościach skrawania. Kąt nakroju ostrza wykańczającego 15° nieznacznie zwiększa siły promieniowe, dlatego jest przydatny do obróbki cienkościennych przedmiotów obrabianych

Maks. głębokość skrawania: 0,15 mm
Kąt natarcia: 0°, 6°, 12°

Materiał skrawający	Węglik spiekany								
	P				M	K	N		
MZG*	1.1 - 1.2	2 - 3 5	4 6	1 - 3	1.1	2 - 3	1.1 - 1.2	2.3	2.1 - 2.2
Rodzaj materiału skrawającego	HP115	HP425	HP016	HP016	HC418	HP426	HP612	HU615	

Kąt natarcia	Wielkość	Specyfikacja	Nr materiałowy							
ujemny	81	SP-DZ81R0-...								
	90	SP-DZ90R0-...								
	91	SP-DZ91R0-...								
	92	SP-DZ92R0-...								
	93	SP-DZ93R0-...								

neutralny	81	SP-DZ81R0-...					30685653				
	90	WP-DZ90R0-...					30685654				
	91	WP-DZ91R0-...					30664932				
	92	WP-DZ92R0-...					30685655				
	93	WP-DZ93R0-...					30667699				

dodatni	81	SP-DZ81R6-...	30668927	30668928	31090592	31090592		30914351		30668926	
	90	WP-DZ90R6-...	30668936	30668785	31034657	31034657		30914370		30668935	
	91	WP-DZ91R6-...	30668949	30668950	31028496	31028496		30914400		30668947	
	92	WP-DZ92R6-...	30668960	30668961	31100878	31100878		30914435		30668959	
	93	WP-DZ93R6-...	30668969	30668970	31069730	31069730		30914474		30668968	

wysoki dodatni	81	SP-DZ81R2-...							30685663		30668923
	90	WP-DZ90R2-...							30685664		30668933
	91	WP-DZ91R2-...							30685665		30668942
	92	WP-DZ92R2-...							30685666		30668956
	93	WP-DZ93R2-...							30685667		30668965

* Grupa materiałowa wg MAPAL

Płytki skrawające z nakrojem EK

Do narzędzi z listwami prowadzącymi

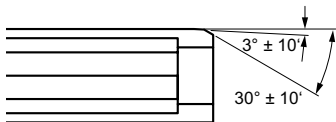

Nakrój EK

Stosować tylko wtedy, gdy wymagana jest mała długość nakroju 0,6 mm, do wszystkich materiałów obrabianych; nie przekraczać maks. prędkości posuwu 0,2 mm/obr.

Maks. głębokość skrawania: 0,15 mm
Kąt natarcia: 0°, 6°, 12°

Materiał skrawający	Węglik spiekany								
	P				M	K	N		
MZG*	1.1 - 1.2	2 - 3 5	4 6	1 - 3	1.1	2 - 3	1.1 - 1.2	2.3	2.1 - 2.2
Rodzaj materiału skrawającego	HP115	HP425	HP016	HP016	HC418	HP426	HP612	HU615	

Kąt natarcia	Wielkość	Specyfikacja	Nr materiałowy							
ujemny	181	SP-EK181R0-...								
	150	SP-EK150R0-...								
	151	SP-EK151R0-...								
	152	SP-EK152R0-...								
	153	SP-EK153R0-...								

neutralny	181	SP-EK181R0-...								
	150	WP-EK150R0-...								
	151	WP-EK151R0-...								
	152	WP-EK152R0-...								
	153	WP-EK153R0-...								

dodatni	181	SP-EK181R6-...	30681706	30681707	31100872	31100872				30681705	
	150	WP-EK150R6-...	30668978	30668979	31100873	31100873				30668977	
	151	WP-EK151R6-...	30668987	30389077	31049120	31049120				30668986	
	152	WP-EK152R6-...	30668999	30669000	30990556	30990556				30668998	
	153	WP-EK153R6-...	30669009	30669010	31100874	31100874				30669008	

wysoki dodatni	181	SP-EK181R2-...								30685689		30681702
	150	WP-EK150R2-...								30685690		30668974
	151	WP-EK151R2-...								30685691		30668983
	152	WP-EK152R2-...								30685692		30668993
	153	WP-EK153R2-...								30685693		30669006

* Grupa materiałowa wg MAPAL

Płytki skrawające z nakrojem SZ

Do narzędzi z listwami prowadzącymi

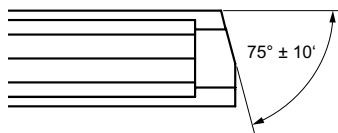

Nakrój SZ

Szczególnie przydatny do stopów aluminiowych, bardzo dobra jakość powierzchni przy małych posuwach. Dokładne dotrzymanie wymiarów skrawania. Kąt nakroju ostrza głównego 75° zmniejsza siły promieniowe, dlatego jest szczególnie przydatny do obróbki cienkościennych przedmiotów obrabianych.

Maks. głębokość skrawania: 1,00 mm
Kąt natarcia: 6°, 12°

Materiał skrawający	Węgiel spiekany									
	P			M	K			N		
MZG*	1.1 - 1.2	2 - 3 5	4 6	1 - 3	1.1	2 - 3	1.1 - 1.2	2.3	2.1 - 2.2	
Rodzaj materiału skrawającego	HP115	HP425	HP016	HP016	HC418	HP426	HP612	HU615		

Kąt natarcia	Wielkość	Specyfikacja	Nr materiałowy							
ujemny	81	SP-SZ81R0-...								
	90	SP-SZ90R0-...								
	91	SP-SZ91R0-...								
	92	SP-SZ92R0-...								
	93	SP-SZ93R0-...								

neutralny	81	SP-SZ81R0-...								
	90	WP-SZ90R0-...								
	91	WP-SZ91R0-...								
	92	WP-SZ92R0-...								
	93	WP-SZ93R0-...								

dodatni	81	SP-SZ81R6-...							31306727	30669514
	90	WP-SZ90R6-...							31306729	30669523
	91	WP-SZ91R6-...							31306730	30669534
	92	WP-SZ92R6-...							30690795	30669541
	93	WP-SZ93R6-...							31306732	30669549

wysoki dodatni	81	SP-SZ81R2-...								30669511
	90	WP-SZ90R2-...								30669520
	91	WP-SZ91R2-...								30669531
	92	WP-SZ92R2-...								30669538
	93	WP-SZ93R2-...								30669546

* Grupa materiałowa wg MAPAL

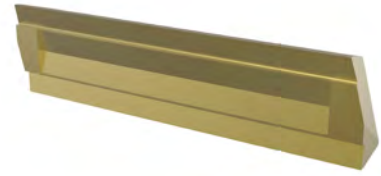

Węglik spiekany		Cermet		PCD		PcBN	
S	H	P	N	K	H		
1 - 2	1.1	1 - 3 5	1 - 2		1.1 - 1.2		
HU615	HP016	CP122	PU620	FU485	FU801		
Nr materiałowy		Nr materiałowy		Nr materiałowy		Nr materiałowy	
				30669493**			
				30669494**			
				30669495**			
				30669498**			
				30669502**			

Zalecane parametry skrawania - patrz koniec rozdziału.
Ostrza z nakrojem specjalnym dostępne na zapytanie.

Zalecane parametry skrawania dla płytek skrawających z nakrojem AS

Posuw i prędkość skrawania

AS-HP115

MZG*	Materiał obrabiany	Wytrzymałość/twardość [N/mm ²] [HRC]	Prędkość cięcia v _c (m/min)		Posuw f _z (mm/z)	
			Chłodzenie wewnętrzne	Chłodzenie zewnętrzne		
P P1	P1.1	Stale konstrukcyjne, użytkowe i uszlachetnione, stale niestopowe	< 700	80	40	0,150
	P1.2	Stale konstrukcyjne, użytkowe i uszlachetnione, stale niestopowe	< 1200	70	35	0,150

AS-HP425

MZG*	Materiał obrabiany	Wytrzymałość/twardość [N/mm ²] [HRC]	Prędkość cięcia v _c (m/min)		Posuw f _z (mm/z)	
			Chłodzenie wewnętrzne	Chłodzenie zewnętrzne		
P P2 P3 P5	P2.1	Stale azotowane, użytkowe i uszlachetnione, stale stopowe	< 900	100	50	0,150
	P2.2	Stale azotowane, użytkowe i uszlachetnione, stale stopowe	< 1400	80	40	0,150
	P3.1	Stale narzędziowe, łożyskowe, sprężynowe i stale szybko tnące**	< 900	100	50	0,150
	P3.2	Stale narzędziowe, łożyskowe, sprężynowe i stale szybko tnące**	< 1500	80	40	0,150
	P5.1	Staliwo		80	40	0,150

AS-HP016

MZG*	Materiał obrabiany	Wytrzymałość/twardość [N/mm ²] [HRC]	Prędkość cięcia v _c (m/min)		Posuw f _z (mm/z)	
			Chłodzenie wewnętrzne	Chłodzenie zewnętrzne		
P P4 P6	P4.1	Stale nierdzewne, ferrytyczne i martenzytyczne		50	25	0,120
	P6.1	Staliwo nierdzewne, ferrytyczne i martenzytyczne		40	20	0,120
M M1 M2 M3	M1.1	Stale nierdzewne, austenityczne	< 700	50	25	0,120
	M1.2	Stale nierdzewne, ferrytyczne/austenityczne (Duplex)	< 1000	30	15	0,120
	M2.1	Staliwo nierdzewne, austenityczne	< 700	50	25	0,120
M3.1	Staliwo nierdzewne, ferrytyczne/austenityczne (Duplex)	< 1000	30	15	0,120	

AS-HP612

MZG*	Materiał obrabiany	Wytrzymałość/twardość [N/mm ²] [HRC]	Prędkość cięcia v _c (m/min)		Posuw f _z (mm/z)	
			Chłodzenie wewnętrzne	Chłodzenie zewnętrzne		
N N1	N1.1	Aluminium, niestopowe i stopowe < 3 % Si		160	80	0,150
	N1.2	Aluminium, stopowe ≤ 7 % Si		160	80	0,150

* Grupa materiałowa wg MAPAL

** Jeśli składniki stopu Cr, Mo, Ni, V, W wynoszą łącznie > 8%, należy wybrać następną w kolejności grupę materiałową MAPAL.

AS-HU615

MZG*		Materiał obrabiany	Wytrzymałość/twardość [N/mm ²] [HRC]	Prędkość cięcia v _c (m/min)		Posuw f _z (mm/z)
				Chłodzenie wewnętrzne	Chłodzenie zewnętrzne	
N	N2	N2.1 Miedź, niestopowa i niskostopowa	< 300	100	50	0,150
		N2.2 Miedź, stopowa	> 300	100	50	0,150
		N2.3 Mosiądz, brąz, spiż	< 1200	100	50	0,150
S	S1 S2	S1.1 Tytan, stopy tytanu	< 400	30	15	0,120
		S2.1 Tytan, stopy tytanu	< 1200	20	10	0,120
		S2.2 Tytan, stopy tytanu	> 1200	20	10	0,100

AS-CP122

MZG*		Materiał obrabiany	Wytrzymałość/twardość [N/mm ²] [HRC]	Prędkość cięcia v _c (m/min)		Posuw f _z (mm/z)
				Chłodzenie wewnętrzne	Chłodzenie zewnętrzne	
P	P1	P1.1 Stale konstrukcyjne, użytkowe i uszlachetnione, stale niestopowe	< 700	180	90	0,150
		P1.2 Stale konstrukcyjne, użytkowe i uszlachetnione, stale niestopowe	< 1200	160	80	0,120
	P2	P2.1 Stale azotowane, użytkowe i uszlachetnione, stale stopowe	< 900	160	80	0,150
		P2.2 Stale azotowane, użytkowe i uszlachetnione, stale stopowe	< 1400	140	70	0,120
	P3	P3.1 Stale narzędziowe, łożyskowe, sprężynowe i stale szybko tnące**	< 800	160	80	0,150
		P3.2 Stale narzędziowe, łożyskowe, sprężynowe i stale szybko tnące**	< 1000	160	80	0,150
		P3.3 Stale narzędziowe, łożyskowe, sprężynowe i stale szybko tnące**	< 1500	140	70	0,120
	P5	P5.1 Staliwo		140	70	0,120

AS-PU620

MZG*		Materiał obrabiany	Wytrzymałość/twardość [N/mm ²] [HRC]	Prędkość cięcia v _c (m/min)		Posuw f _z (mm/z)
				Chłodzenie wewnętrzne	Chłodzenie zewnętrzne	
N	N1	N1.1 Aluminium, niestopowe i stopowe < 3 % Si		230	115	0,150
		N1.2 Aluminium, stopowe ≤ 7 % Si		230	115	0,150
		N1.3 Aluminium, stopowe > 7-12 % Si		230	115	0,150
		N1.4 Aluminium, stopowe > 12 % Si		230	115	0,150
	N2	N2.1 Miedź, niestopowa i niskostopowa	< 300	180	90	0,150
		N2.2 Miedź, stopowa	> 300	180	90	0,150
		N2.3 Mosiądz, brąz, spiż	< 1200	180	90	0,150

Podane parametry skrawania to wartości orientacyjne.

Optymalne wartości dla danego przypadku obróbki należy ustalić w ramach próby lub podczas obróbki.

Zalecane parametry skrawania dla płytek skrawających z nakrojem AZ

Posuw i prędkość skrawania

AZ-HC418

MZG*	Materiał obrabiany	Wytrzymałość/twardość [N/mm ²] [HRC]	Prędkość cięcia v_c (m/min)		Posuw f_z (mm/z)
			Chłodzenie wewnętrzne	Chłodzenie zewnętrzne	
K K1 K1.1	Żeliwo z grafitem płatkowym (żeliwo szare), GJL	< 300	110	55	0,150

AZ-HP426

MZG*	Materiał obrabiany	Wytrzymałość/twardość [N/mm ²] [HRC]	Prędkość cięcia v_c (m/min)		Posuw f_z (mm/z)	
			Chłodzenie wewnętrzne	Chłodzenie zewnętrzne		
K K2	K2.1	Żeliwo sferoidalne, GJS	< 500	110	55	0,150
	K2.2	Żeliwo sferoidalne, GJS	≤ 800	100	50	0,150
	K2.3	Żeliwo sferoidalne, GJS	> 800	80	40	0,150
K K3	K3.1	Żeliwo wermikularne, GJV, (żeliwo ciągliwe), GJL	< 500	80	40	0,150
	K3.2	Żeliwo wermikularne, GJV, (żeliwo ciągliwe), GJL	> 500	80	40	0,150

AZ-HP612

MZG*	Materiał obrabiany	Wytrzymałość/twardość [N/mm ²] [HRC]	Prędkość cięcia v_c (m/min)		Posuw f_z (mm/z)
			Chłodzenie wewnętrzne	Chłodzenie zewnętrzne	
N N1	N1.1	Aluminium, niestopowe i stopowe < 3 % Si	160	80	0,150
	N1.2	Aluminium, stopowe ≤ 7 % Si	160	80	0,150

AZ-HU615

MZG*	Materiał obrabiany	Wytrzymałość/twardość [N/mm ²] [HRC]	Prędkość cięcia v_c (m/min)		Posuw f_z (mm/z)	
			Chłodzenie wewnętrzne	Chłodzenie zewnętrzne		
N2	N2.1	Miedź, niestopowa i niskostopowa	< 300	110	55	0,150
	N2.2	Miedź, stopowa	> 300	110	55	0,150
	N2.3	Mosiądz, brąz, spiż	< 1200	110	55	0,150

AZ-PU620

MZG*	Materiał obrabiany	Wytrzymałość/twardość [N/mm ²] [HRC]	Prędkość cięcia v _c (m/min)		Posuw f _z (mm/z)	
			Chłodzenie wewnętrzne	Chłodzenie zewnętrzne		
N	N1.1	Aluminium, niestopowe i stopowe < 3 % Si	230	115	0,150	
	N1.2	Aluminium, stopowe ≤ 7 % Si	230	115	0,150	
	N1.3	Aluminium, stopowe > 7-12 % Si	230	115	0,150	
	N1.4	Aluminium, stopowe > 12 % Si	230	115	0,150	
N2	N2.1	Miedź, niestopowa i niskostopowa	< 300	180	90	0,150
	N2.2	Miedź, stopowa	> 300	180	90	0,150
	N2.3	Mosiądz, brąz, spiż	< 1200	180	90	0,150

AZ-FU485

MZG*	Materiał obrabiany	Wytrzymałość/twardość [N/mm ²] [HRC]	Prędkość cięcia v _c (m/min)		Posuw f _z (mm/z)	
			Chłodzenie wewnętrzne	Chłodzenie zewnętrzne		
K K1	K1.1	Żeliwo z grafitem płatkowym (żeliwo szare), GJL	< 300	160	80	0,150

Podane parametry skrawania to wartości orientacyjne.

Optymalne wartości dla danego przypadku obróbki należy ustalić w ramach próby lub podczas obróbki.

Zalecane parametry skrawania dla płytek skrawających z nakrojem DZ

Posuw i prędkość skrawania

DZ-HP115

MZG*	Materiał obrabiany	Wytrzymałość/twardość [N/mm ²] [HRC]	Prędkość cięcia v _c (m/min)		Posuw f _z (mm/z)	
			Chłodzenie wewnętrzne	Chłodzenie zewnętrzne		
P P1	P1.1	Stale konstrukcyjne, użytkowe i uszlachetnione, stale niestopowe	< 700	80	40	0,150
	P1.2	Stale konstrukcyjne, użytkowe i uszlachetnione, stale niestopowe	< 1200	70	35	0,150

DZ-HP425

MZG*	Materiał obrabiany	Wytrzymałość/twardość [N/mm ²] [HRC]	Prędkość cięcia v _c (m/min)		Posuw f _z (mm/z)	
			Chłodzenie wewnętrzne	Chłodzenie zewnętrzne		
P P2 P3 P5	P2.1	Stale azotowane, użytkowe i uszlachetnione, stale stopowe	< 900	100	50	0,150
	P2.2	Stale azotowane, użytkowe i uszlachetnione, stale stopowe	< 1400	80	40	0,150
	P3.1	Stale narzędziowe, łożyskowe, sprężynowe i stale szybko tnące**	< 900	100	50	0,150
	P3.2	Stale narzędziowe, łożyskowe, sprężynowe i stale szybko tnące**	< 1500	80	40	0,150
	P5.1	Staliwo		80	40	0,150

DZ-HP016

MZG*	Materiał obrabiany	Wytrzymałość/twardość [N/mm ²] [HRC]	Prędkość cięcia v _c (m/min)		Posuw f _z (mm/z)	
			Chłodzenie wewnętrzne	Chłodzenie zewnętrzne		
P P4 P6	P4.1	Stale nierdzewne, ferrytyczne i martenzytyczne		50	25	0,120
	P6.1	Staliwo nierdzewne, ferrytyczne i martenzytyczne		40	20	0,120
M M1 M2 M3	M1.1	Stale nierdzewne, austenityczne	< 700	50	25	0,120
	M1.2	Stale nierdzewne, ferrytyczne/austenityczne (Duplex)	< 1000	30	15	0,120
	M2.1	Staliwo nierdzewne, austenityczne	< 700	50	25	0,120
M3.1	Staliwo nierdzewne, ferrytyczne/austenityczne (Duplex)	< 1000	30	15	0,120	

DZ-HC418

MZG*	Materiał obrabiany	Wytrzymałość/twardość [N/mm ²] [HRC]	Prędkość cięcia v _c (m/min)		Posuw f _z (mm/z)	
			Chłodzenie wewnętrzne	Chłodzenie zewnętrzne		
K K1	K1.1	Żeliwo z grafitem płatkowym (żeliwo szare), GJL	< 300	100	50	0,150

* Grupa materiałowa wg MAPAL

** Jeśli składniki stopu Cr, Mo, Ni, V, W wynoszą łącznie > 8%, należy wybrać następną w kolejności grupę materiałową MAPAL.

DZ-HP426

MZG*	Materiał obrabiany	Wytrzymałość/twardość [N/mm ²] [HRC]	Prędkość cięcia v _c (m/min)		Posuw f _z (mm/z)	
			Chłodzenie wewnętrzne	Chłodzenie zewnętrzne		
K2	K2.1	Żeliwo sferoidalne, GJS	< 500	100	50	0,150
	K2.2	Żeliwo sferoidalne, GJS	≤ 800	90	45	0,150
	K2.3	Żeliwo sferoidalne, GJS	> 800	80	40	0,150
K3	K3.1	Żeliwo wermikularne, GJV, (żeliwo ciągliwe), GJL	< 500	70	35	0,150
	K3.2	Żeliwo wermikularne, GJV, (żeliwo ciągliwe), GJL	> 500	70	35	0,150

DZ-HP612

MZG*	Materiał obrabiany	Wytrzymałość/twardość [N/mm ²] [HRC]	Prędkość cięcia v _c (m/min)		Posuw f _z (mm/z)	
			Chłodzenie wewnętrzne	Chłodzenie zewnętrzne		
N N1	N1.1	Aluminium, niestopowe i stopowe < 3 % Si		160	80	0,150
	N1.2	Aluminium, stopowe ≤ 7 % Si		160	80	0,150

DZ-HU615

MZG*	Materiał obrabiany	Wytrzymałość/twardość [N/mm ²] [HRC]	Prędkość cięcia v _c (m/min)		Posuw f _z (mm/z)	
			Chłodzenie wewnętrzne	Chłodzenie zewnętrzne		
N N2	N2.1	Miedź, niestopowa i niskostopowa	< 300	100	50	0,150
	N2.2	Miedź, stopowa	> 300	100	50	0,150
	N2.3	Mosiądz, brąz, spiż	< 1200	100	50	0,150
S S1 S2	S1.1	Tytan, stopy tytanu	< 400	30	15	0,120
	S2.1	Tytan, stopy tytanu	< 1200	20	10	0,120
	S2.2	Tytan, stopy tytanu	> 1200	20	10	0,100

DZ-HP016

MZG*	Materiał obrabiany	Wytrzymałość/twardość [N/mm ²] [HRC]	Prędkość cięcia v _c (m/min)		Posuw f _z (mm/z)	
			Chłodzenie wewnętrzne	Chłodzenie zewnętrzne		
H H1 H1.1	Stal utwardzana/staliwo	45 - 55		30	15	0,12

Podane parametry skrawania to wartości orientacyjne.

Optymalne wartości dla danego przypadku obróbki należy ustalić w ramach próby lub podczas obróbki.

Zalecane parametry skrawania dla płytek skrawających z nakrojem DZ

Posuw i prędkość skrawania

DZ-CP122

MZG*	Materiał obrabiany	Wytrzymałość/twardość [N/mm ²] [HRC]	Prędkość cięcia v _c (m/min)		Posuw f _z (mm/z)	
			Chłodzenie wewnętrzne	Chłodzenie zewnętrzne		
P1	P1.1	Stale konstrukcyjne, użytkowe i uszlachetnione, stale niestopowe	< 700	180	80	0,150
	P1.2	Stale konstrukcyjne, użytkowe i uszlachetnione, stale niestopowe	< 1200	160	80	0,120
P2	P2.1	Stale azotowane, użytkowe i uszlachetnione, stale stopowe	< 900	160	80	0,150
	P2.2	Stale azotowane, użytkowe i uszlachetnione, stale stopowe	< 1400	140	70	0,120
P3	P3.1	Stale narzędziowe, łożyskowe, sprężynowe i stale szybko tnące**	< 800	160	80	0,150
	P3.2	Stale narzędziowe, łożyskowe, sprężynowe i stale szybko tnące**	< 1000	160	80	0,150
	P3.3	Stale narzędziowe, łożyskowe, sprężynowe i stale szybko tnące**	< 1500	140	70	0,120
P5	P5.1	Staliwo		140	70	0,120

DZ-PU620

MZG*	Materiał obrabiany	Wytrzymałość/twardość [N/mm ²] [HRC]	Prędkość cięcia v _c (m/min)		Posuw f _z (mm/z)	
			Chłodzenie wewnętrzne	Chłodzenie zewnętrzne		
N1	N1.1	Aluminium, niestopowe i stopowe < 3 % Si		230	150	0,15
	N1.2	Aluminium, stopowe ≤ 7 % Si		230	150	0,15
	N1.3	Aluminium, stopowe > 7-12 % Si		230	150	0,15
	N1.4	Aluminium, stopowe > 12 % Si		230	150	0,15
N2	N2.1	Miedź, niestopowa i niskostopowa	< 300	180	90	0,15
	N2.2	Miedź, stopowa	> 300	180	90	0,15
	N2.3	Mosiądz, brąz, spiż	< 1200	180	90	0,15

DZ-FU485

MZG*	Materiał obrabiany	Wytrzymałość/twardość [N/mm ²] [HRC]	Prędkość cięcia v _c (m/min)		Posuw f _z (mm/z)	
			Chłodzenie wewnętrzne	Chłodzenie zewnętrzne		
K K1	K1.1	Żeliwo z grafitem płatkowym (żeliwo szare), GJL	< 300	150	75	0,150

DZ-FU801

MZG*	Materiał obrabiany	Wytrzymałość/twardość [N/mm ²] [HRC]	Prędkość cięcia v _c (m/min)		Posuw f _z (mm/z)	
			Chłodzenie wewnętrzne	Chłodzenie zewnętrzne		
H H1	H1.1	Stal utwardzana/staliwo	45 - 55	60	30	0,100
	H1.2	Stal utwardzana/staliwo	55 - 64	50	25	0,080

* Grupa materiałowa wg MAPAL

** Jeśli składniki stopu Cr, Mo, Ni, V, W wynoszą łącznie > 8%, należy wybrać następną w kolejności grupę materiałową MAPAL.

Zalecane parametry skrawania dla płytek skrawających z nakrojem EK

Posuw i prędkość skrawania

EK-HP115

MZG*	Materiał obrabiany	Wytrzymałość/twardość [N/mm ²] [HRC]	Prędkość cięcia v _c (m/min)		Posuw f _z (mm/z)	
			Chłodzenie wewnętrzne	Chłodzenie zewnętrzne		
P P1	P1.1	Stale konstrukcyjne, użytkowe i uszlachetnione, stale niestopowe	< 700	80	40	0,150
	P1.2	Stale konstrukcyjne, użytkowe i uszlachetnione, stale niestopowe	< 1200	70	35	0,150

EK-HP425

MZG*	Materiał obrabiany	Wytrzymałość/twardość [N/mm ²] [HRC]	Prędkość cięcia v _c (m/min)		Posuw f _z (mm/z)	
			Chłodzenie wewnętrzne	Chłodzenie zewnętrzne		
P P2 P3 P5	P2.1	Stale azotowane, użytkowe i uszlachetnione, stale stopowe	< 900	100	50	0,150
	P2.2	Stale azotowane, użytkowe i uszlachetnione, stale stopowe	< 1400	80	40	0,150
	P3.1	Stale narzędziowe, łożyskowe, sprężynowe i stale szybko tnące**	< 900	100	50	0,150
	P3.2	Stale narzędziowe, łożyskowe, sprężynowe i stale szybko tnące**	< 1500	80	40	0,150
	P5.1	Staliwo		80	40	0,150

EK-HP016

MZG*	Materiał obrabiany	Wytrzymałość/twardość [N/mm ²] [HRC]	Prędkość cięcia v _c (m/min)		Posuw f _z (mm/z)	
			Chłodzenie wewnętrzne	Chłodzenie zewnętrzne		
P4 P6	P4.1	Stale nierdzewne, ferrytyczne i martenzytyczne		50	25	0,120
	P6.1	Staliwo nierdzewne, ferrytyczne i martenzytyczne		40	20	0,120
M M1 M2 M3	M1.1	Stale nierdzewne, austenityczne	< 700	50	25	0,120
	M1.2	Stale nierdzewne, ferrytyczne/austenityczne (Duplex)	< 1000	30	15	0,120
	M2.1	Staliwo nierdzewne, austenityczne	< 700	50	25	0,120
	M3.1	Staliwo nierdzewne, ferrytyczne/austenityczne (Duplex)	< 1000	30	15	0,120

EK-HP612

MZG*	Materiał obrabiany	Wytrzymałość/twardość [N/mm ²] [HRC]	Prędkość cięcia v _c (m/min)		Posuw f _z (mm/z)	
			Chłodzenie wewnętrzne	Chłodzenie zewnętrzne		
N N1	N1.1	Aluminium, niestopowe i stopowe < 3 % Si		160	80	0,15
	N1.2	Aluminium, stopowe ≤ 7 % Si		160	80	0,15

Podane parametry skrawania to wartości orientacyjne.

Optymalne wartości dla danego przypadku obróbki należy ustalić w ramach próby lub podczas obróbki.

Zalecane parametry skrawania dla płytek skrawających z nakrojem EK

Posuw i prędkość skrawania

EK-HU615

MZG*	Materiał obrabiany	Wytrzymałość/twardość [N/mm ²] [HRC]	Prędkość cięcia v _c (m/min)		Posuw f _z (mm/z)	
			Chłodzenie wewnętrzne	Chłodzenie zewnętrzne		
N	N2.1	Miedź, niestopowa i niskostopowa	< 300	100	50	0,150
	N2.2	Miedź, stopowa	> 300	100	50	0,150
	N2.3	Mosiądz, brąz, spiż	< 1200	100	50	0,150
S	S1.1	Tytan, stopy tytanu	< 400	30	15	0,120
	S2.1	Tytan, stopy tytanu	< 1200	20	10	0,120
	S2.2	Tytan, stopy tytanu	> 1200	20	10	0,100

EK-CP122

MZG*	Materiał obrabiany	Wytrzymałość/twardość [N/mm ²] [HRC]	Prędkość cięcia v _c (m/min)		Posuw f _z (mm/z)	
			Chłodzenie wewnętrzne	Chłodzenie zewnętrzne		
P	P1.1	Stale konstrukcyjne, użytkowe i uszlachetnione, stale niestopowe	< 700	180	90	0,150
	P1.2	Stale konstrukcyjne, użytkowe i uszlachetnione, stale niestopowe	< 1200	160	80	0,120
	P2.1	Stale azotowane, użytkowe i uszlachetnione, stale stopowe	< 900	160	80	0,150
	P2.2	Stale azotowane, użytkowe i uszlachetnione, stale stopowe	< 1400	140	70	0,120
	P3.1	Stale narzędziowe, łożyskowe, sprężynowe i stale szybko tnące**	< 800	160	80	0,150
	P3.2	Stale narzędziowe, łożyskowe, sprężynowe i stale szybko tnące**	< 1000	160	80	0,150
	P3.3	Stale narzędziowe, łożyskowe, sprężynowe i stale szybko tnące**	< 1500	140	70	0,120
	P5.1	Staliwo		140	70	0,120

EK-PU620

MZG*	Materiał obrabiany	Wytrzymałość/twardość [N/mm ²] [HRC]	Prędkość cięcia v _c (m/min)		Posuw f _z (mm/z)	
			Chłodzenie wewnętrzne	Chłodzenie zewnętrzne		
N	N1.1	Aluminium, niestopowe i stopowe < 3 % Si		230	115	0,150
	N1.2	Aluminium, stopowe ≤ 7 % Si		230	115	0,150
	N1.3	Aluminium, stopowe > 7-12 % Si		230	115	0,150
	N1.4	Aluminium, stopowe > 12 % Si		230	115	0,150
	N2.1	Miedź, niestopowa i niskostopowa	< 300	180	90	0,150
	N2.2	Miedź, stopowa	> 300	180	90	0,150
	N2.3	Mosiądz, brąz, spiż	< 1200	180	90	0,150

* Grupa materiałowa wg MAPAL

** Jeśli składniki stopu Cr, Mo, Ni, V, W wynoszą łącznie > 8%, należy wybrać następną w kolejności grupę materiałową MAPAL.

Zalecane parametry skrawania dla płytek skrawających z nakrojem SZ

Posuw i prędkość skrawania

SZ-HP612

MZG*	Materiał obrabiany	Wytrzymałość/twardość [N/mm ²] [HRC]	Prędkość cięcia v _c (m/min)		Posuw f _z (mm/z)
			Chłodzenie wewnętrzne	Chłodzenie zewnętrzne	
N N1	N1.1 Aluminium, niestopowe i stopowe < 3 % Si		160	80	0,120
	N1.2 Aluminium, stopowe ≤ 7 % Si		160	80	0,120

SZ-HU615

MZG*	Materiał obrabiany	Wytrzymałość/twardość [N/mm ²] [HRC]	Prędkość cięcia v _c (m/min)		Posuw f _z (mm/z)
			Chłodzenie wewnętrzne	Chłodzenie zewnętrzne	
N2	N2.1 Miedź, niestopowa i niskostopowa	< 300	100	50	0,120
	N2.2 Miedź, stopowa	> 300	100	50	0,120
	N2.3 Mosiądz, brąz, spiż	< 1200	100	50	0,120

SZ-PU620

MZG*	Materiał obrabiany	Wytrzymałość/twardość [N/mm ²] [HRC]	Prędkość cięcia v _c (m/min)		Posuw f _z (mm/z)	
			Chłodzenie wewnętrzne	Chłodzenie zewnętrzne		
N	N1	N1.1 Aluminium, niestopowe i stopowe < 3 % Si		230	115	0,120
		N1.2 Aluminium, stopowe ≤ 7 % Si		230	115	0,120
		N1.3 Aluminium, stopowe > 7-12 % Si		230	115	0,120
		N1.4 Aluminium, stopowe > 12 % Si		230	115	0,120
N	N2	N2.1 Miedź, niestopowa i niskostopowa	< 300	180	90	0,120
		N2.2 Miedź, stopowa	> 300	180	90	0,120
		N2.3 Mosiądz, brąz, spiż	< 1200	180	90	0,120

Podane parametry skrawania to wartości orientacyjne.

Optymalne wartości dla danego przypadku obróbki należy ustalić w ramach próby lub podczas obróbki.

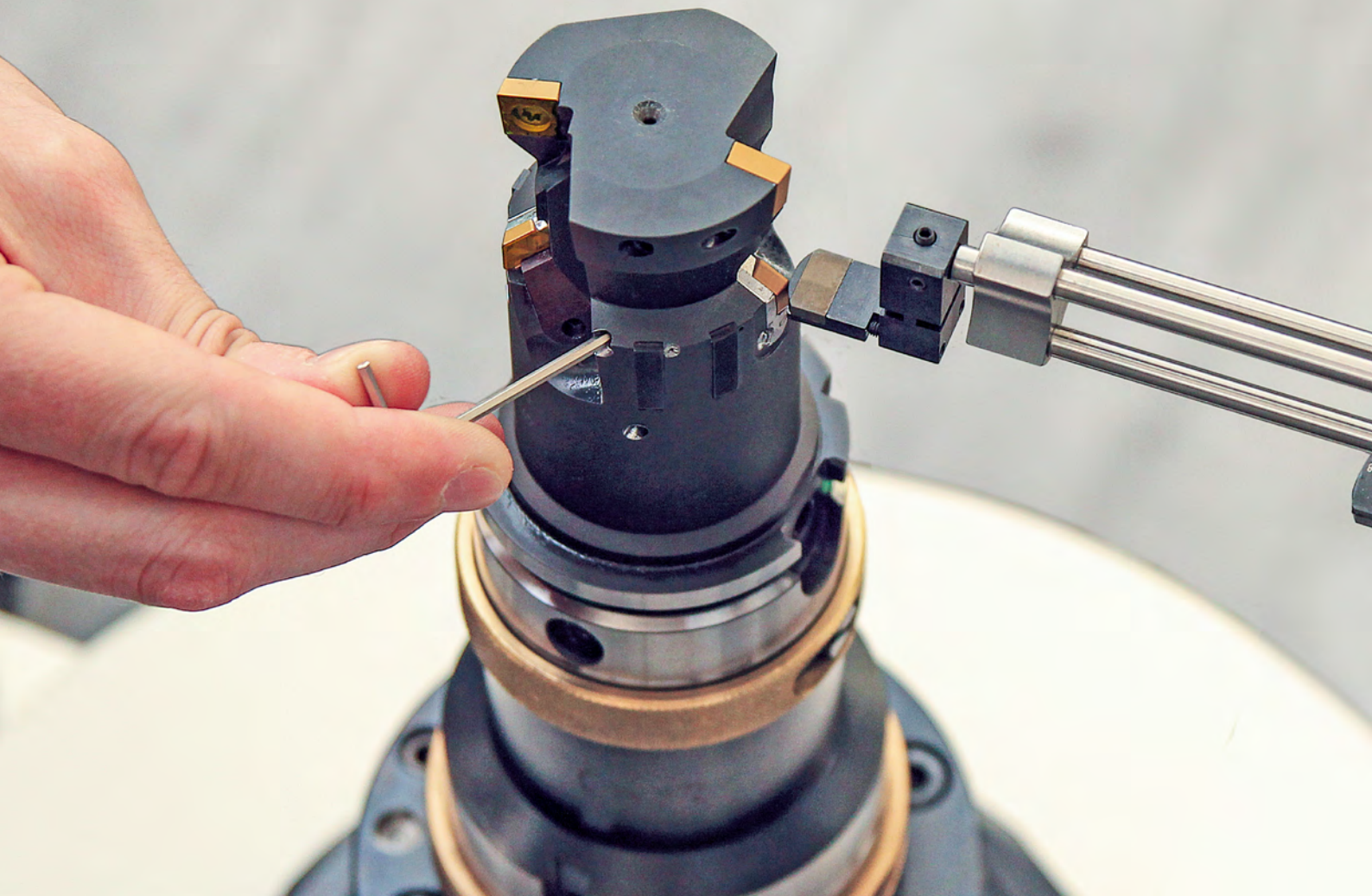

System EasyAdjust

Łatwe ustawianie narzędzi w najkrótszym czasie

Opracowanie systemu EasyAdjust zaowocowało znaczną redukcją czasu potrzebnego na przygotowanie rozwiertaka do pracy.

Najważniejszym elementem systemu EasyAdjust jest innowacyjna kasetka, która pozwala na stabilne mocowanie bez luzów sześciolubczterostrzowych płytek skrawających i zapewnia odpowiednią zbieżność płytki dopasowaną do gatunku obrabianego materiału.

W przeciwieństwie do tradycyjnych rozwiertaków uzbrajanych w płytki WP i HX, w rozwiertakach z systemem EasyAdjust pożądaną średnicę narzędzia ustawia się za pomocą jednej śruby. Do różnych wartości pochyleń płytek dostępne są odpowiednie kasetki. Możliwy jest

ich wybór i wykorzystanie w zależności od zastosowania – niezależnie od płytki skrawającej i narzędzia.

Znaczące korzyści ekonomiczne

Z zastosowania systemu wynikają konkretne korzyści ekonomiczne: płytki skrawające HX z sześcioma użytkowymi krawędziami skrawającymi mogą być szybko i precyzyjnie umieszczane w kasetkach o różnym pochyleniu. Narzędzia z systemem EasyAdjust wymagają jedynie regulacji średnicy. W ten sposób zwiększona zostaje stabilność procesu przy wymianie ostrzy. Efekt ten jest tym wyraźniejszy, im więcej ostrzy jest zamontowanych w narzędziu. Dzięki nowemu rozwiązaniu czas potrzebny na regulację każdego ostrza został

skrócony do ułamka dotychczasowej wartości.

ZALETY

- Znaczne zmniejszenie nakładu pracy związanego z ustawianiem
- Narzędzia wymagają jedynie regulacji średnicy
- Duża poprawa ekonomiczności, wygody obsługi i stabilności procesu w porównaniu z narzędziami z listwami prowadzącymi bez systemu EA
- Niezmienne wysoka precyzja

Przegląd systemu

System EasyAdjust w zbliżeniu

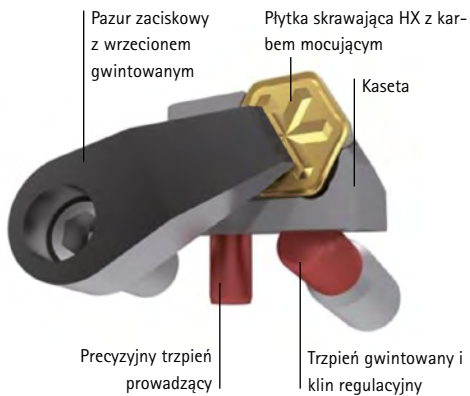

System EasyAdjust składa się z precyzyjnej kasety, w której mocowana jest płytka skrawająca. Precyzyjny trzpień prowadzący kieruje ruchem kasety podczas regulacji. Za pewne trzymanie płytki skrawającej odpowiada karb mocujący, który wraz z pazurem zaciskowym tworzy stabilny, zamknięty siłowo układ.

Narzędzia z systemem EasyAdjust wymagają jedynie regulacji średnicy. Pochylenie płytek jest ustawione wstępnie w kasecie i nie ulega zmianie w przypadku zmiany średnicy.

ZALETY

- Czas ustawiania skrócony o połowę
- Dokładne kierowanie ruchem systemu na precyzyjnym trzpieniu prowadzącym
- Pochylenie płytek ustawione wstępnie w kasecie
- Optymalne wykorzystanie materiału skrawającego dzięki cztero- i sześciostrowym płytkom skrawającym

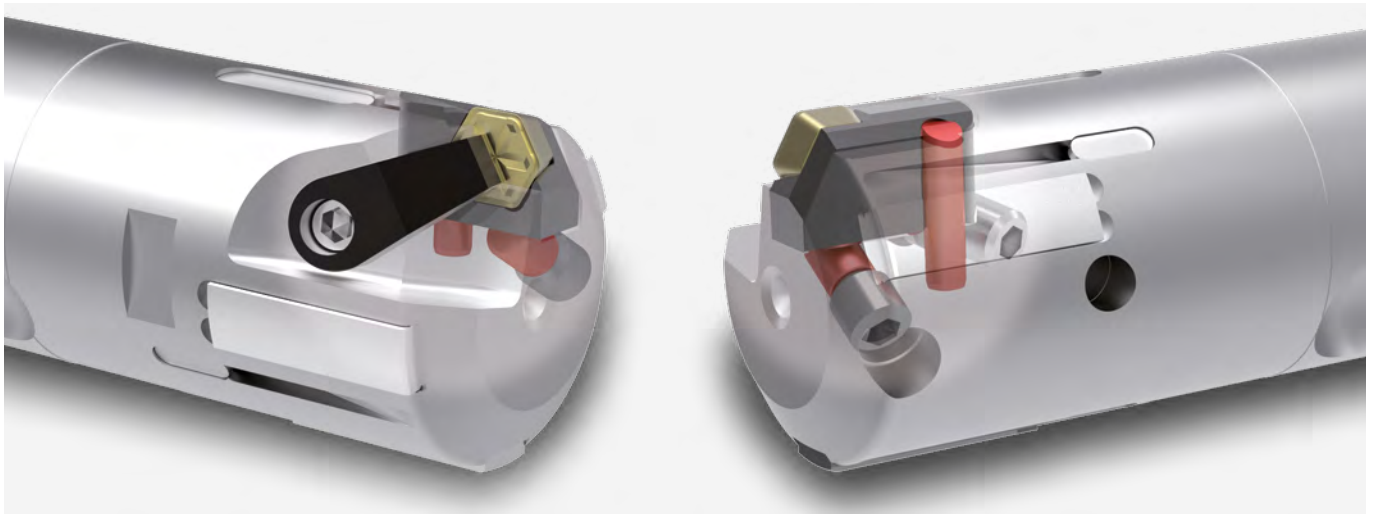

Porównanie czasów ustawiania

System EasyAdjust znacznie skraca czas potrzebny na regulację każdego ostrza.

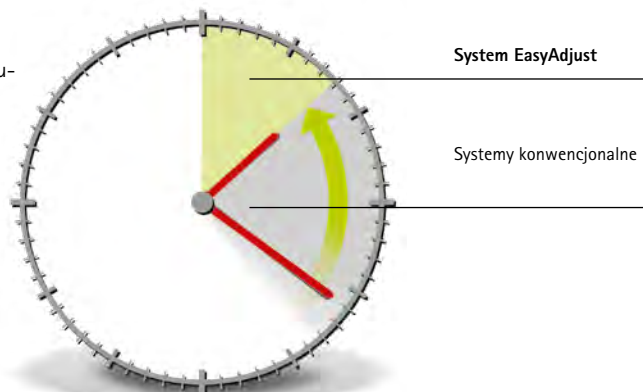

Zbieżność ostrzy

Pochylenie ostrzy ma istotny wpływ na jakość otworu. W zależności od wymagań materiału obrabianego i posuwu MAPAL dobiera taką zbieżność ostrzy w kasecie, jaka jest wymagana w danym przypadku obróbki.

ZALETY

- Regulacja pochyleń niezależnie od płytki skrawającej i korpusu narzędzia
- Różne wartości pochyleń pozwalają na uzyskanie określonych chropowatości
- Optymalne wykończenie powierzchni przed rozpoczęciem kolejnych procesów (np. honowanie)

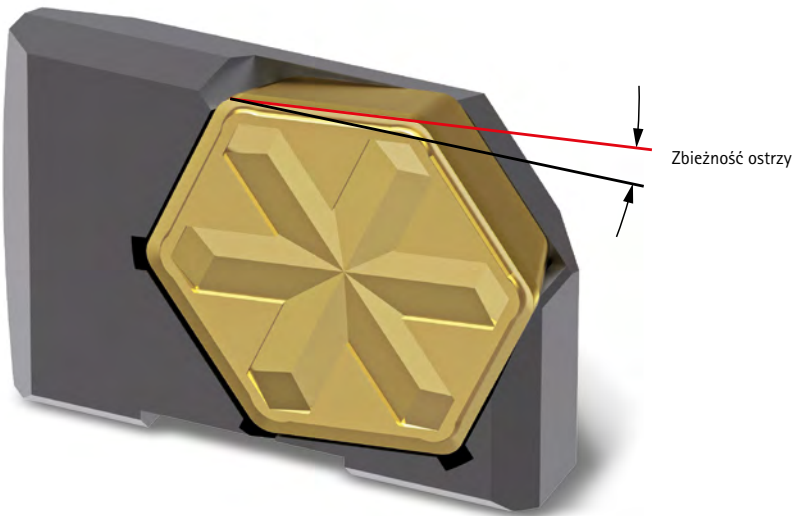

Dwa warianty płytek skrawających

System EasyAdjust może służyć do wykonywania otworów przelotowych i nieprzelotowych i jest oferowany z dwoma rodzajami ostrzy:

Płytki skrawające HX

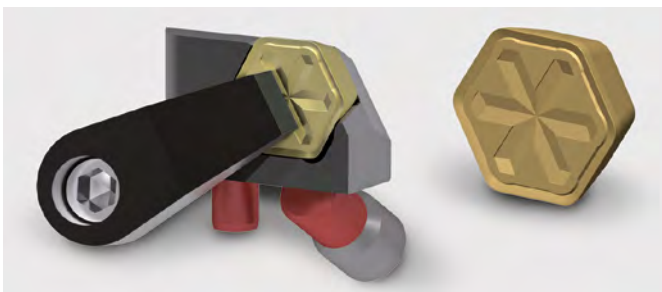

Płytki skrawające HX z sześcioma krawędziami skrawającymi do wykonywania otworów przelotowych.



Otwór przelotowy

Odpowiednie do wykonywania otworów otwartych. Nieodpowiednie do obróbki krawędzi, jeżeli wymagany jest kąt 90°.

Płytki skrawające TEC

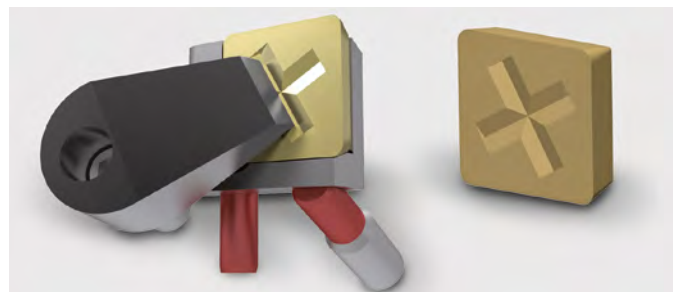

Płytki skrawające TEC z czterema krawędziami skrawającymi i różnymi geometriami nakroju do wykonywania otworów nieprzelotowych i obróbki krawędzi czołowych.







Otwór nieprzelotowy i otwór w krawędzi czołowej

Odpowiednie do otworów zamkniętych i obróbki krawędzi skrawających, z uwzględnieniem długości ostrza.

Zestawienie modeli



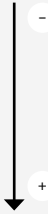

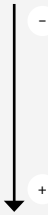
System EasyAdjust z płytkami skrawającymi HX

Kryteria wyboru				Typ ostrza	
Rodzaj otworu	Zakres ϕ : Narzędzie		Stopniowanie pochylenia*		
Otwór przelotowy 	od ϕ 20	B	Wymagania specjalne	Pochylenie 	HX 
		D	Zalecana wersja standardowa		
		F	Wymagania specjalne		
		H			
		K			
		M			
		P			
		R			
	od ϕ 30	B	Wymagania specjalne	Pochylenie 	
		D	Zalecana wersja standardowa		
		F	Wymagania specjalne		
		H			
		K			
		M			
P					
R					

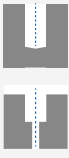
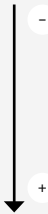

System EasyAdjust z płytkami skrawającymi TEC

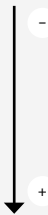
Kryteria wyboru				Typ ostrza	
Rodzaj otworu	Zakres ϕ : Narzędzie		Stopniowanie pochylenia*		
Otwór nieprzelotowy / krawędź czołowa 	od ϕ 20	B	Wymagania specjalne	Pochylenie 	TEC 
		D	Zalecana wersja standardowa		
		F	Wymagania specjalne		
		H			
		K			
		M			
		P			
		R			
	od ϕ 30	B	Wymagania specjalne	Pochylenie 	
		D	Zalecana wersja standardowa		
		F	Wymagania specjalne		
		H			
		K			
		M			
P					
R					

Wymiary podano w mm.

Pasujące płytki skrawające – patrz strona 518.

* Wybór w zależności od wymagań danego elementu w porozumieniu z MAPAL.

Informacja:

Przy zmianie systemu należy zwrócić uwagę na odpowiednie dopasowanie kasety i płytki mocującej.

Płytki skrawające HX do obróbki otworów

Do narzędzi z listwami prowadzącymi

Materiał skrawający			Węglik spiekany								
MZG*			P	M			K	N			
Rodzaj materiału skrawającego			HP342	HP122	HP018	HP018	HC419	HP122	HP612	HU612	
			1.1 - 1.2	2 - 3 5	4 6	1 - 3	1.1	2 - 3	1.1 - 1.2	2.3	2.1 - 2.2
Geometria kształtu wióra	Wielkość	Nacięcie	Specyfikacja	Nr materiałowy							
ujemny	2	R0,8	WP-K1288-2133-...								
	3	R0,8	WP-K1288-2123-...								
neutralny	2	R0,8	WP-606087689-...				30688944				
	3	R0,8	WP-606087714-...				30688981				
dodatni	2	R0,8	WP-HX228RL-...	30685704	30197811	31100892	31100892		30197811		30320977
	3	R0,8	WP-HX238RL-...	30685705	30669024	31100893	31100893		30669024		30669021
wysoki dodatni	2	R0,8	WP-HX128RL-...							30685707	30669011
	3	R0,8	WP-HX138RL-...							30685708	30669015

* Grupa materiałowa wg MAPAL



Węglik spiekany			Cermet		PCD		PcBN	
S		H	P		N		K	H
1 - 2		1.1	1 - 3 5		1 - 2		1.1	1.1 - 1.2
HU612		HP018	CP122		PU620		FU485	FU801
Nr materiałowy			Nr materiałowy		Nr materiałowy		Nr materiałowy	
							30009396**	30033403**
							30008170**	30097476**
		31100892	30222667		31290969**			
		31100893	30222666		31290980**			
30669011								
30669015								

Płytki skrawające TEC do obróbki otworów

Do narzędzi z listwami prowadzącymi

Materiał skrawający	Węglik spiekany								
	P				M	K	N		
MZG*	1.1 - 1.2	2 - 3 5	4 6	1 - 3	1.1	2 - 3	1.1 - 1.2	2.3	2.1 - 2.2
Rodzaj materiału skrawającego	HP115	HP425	HP016	HP016	HC418	HP426	HP612	HU615	

Geometria kształtu wióra	Wielkość	Nacięcie	Specyfikacja	Nr materiałowy							
ujemny	2	AS	WP-TEC2-ASS35R0A-...								
		** EK	WP-TEC2-EKS35R0A-...								
		DZ	WP-TEC2-DZS35R0A-...								
		** R0,4	WP-TEC2-04S35R0A-...								

neutralny	2	AS	WP-TEC2-ASE02R0A-...								
		** EK	WP-TEC2-EKE02R0A-...								
		DZ	WP-TEC2-DZE02R0A-...					31306739			
		** R0,4	WP-TEC2-04E02R0A-...					31306750			

dodatni	2	AS	WP-TEC2-ASF01R1G-...	31099198	30953115	31099199	31099199				31306751
		** EK	WP-TEC2-EKF01R1G-...	31306755	31306756	31306758	31306758				31306761
		DZ	WP-TEC2-DZF01R1G-...	31306854	31100514	31100517	31100517		31306855		31306857
		** R0,4	WP-TEC2-04F01R1J-...	31306873	31306875	31306876	31306876		31306878		31306879

wysoki dodatni	2	AS	WP-TEC2-ASF01R1N-...							31306883	31306887
		** EK	WP-TEC2-EKF01R1N-...							31306903	31306904
		DZ	WP-TEC2-DZF01R1N-...							31306907	31306920
		** R0,4	WP-TEC2-04F01R1U-...							30685231	31306921

** Informacja: Nakroju EK i R0,4 używać tylko do obróbki otworów nieprzelotowych i obróbki powierzchni czołowych w zależności od wymagań stawianych przez dany element



Węglik spiekany		Cermet		PCD		PcBN	
S	H	P	N	K	H		
1 - 2	1.1	1 - 3 5	1 - 2	1.1	1.1 - 1.2		
HU615	HP016	CP122	PU620	FU485	FU801		
Nr materiałowy		Nr materiałowy		Nr materiałowy		Nr materiałowy	
						31306734**	31306735**
						30539027**	30688967**
		31306753	31306754**				
		31306762	31306763**				
	31100517	31306870	31306871**				
	31306876	31306880	30823892**				
	31306887						
	31306904						
	31306920						
	31306921						

Osprzęt do systemu EasyAdjust



Wielkość ostrza TEC	Kasety nożowe do systemu EasyAdjust		Dociski do systemu EasyAdjust	
	Specyfikacja	Nr materiałowy	Specyfikacja	Nr materiałowy
2	BC-EAS-R-42-B	30546828	CP-EAS-R-N2-B	30508276
2	BC-EAS-R-42-D	30498068	CP-EAS-R-N2-D	30561484
2	BC-EAS-R-42-F	30503101	CP-EAS-R-N2-F	30561485
2	BC-EAS-R-42-H	30503104	CP-EAS-R-N2-H	30561487
2	BC-EAS-R-42-K	30546837	CP-EAS-R-N2-K	30561488
2	BC-EAS-R-42-M	30546839	CP-EAS-R-N2-M	30561489
2	BC-EAS-R-42-P	30546840	CP-EAS-R-N2-P	30561490
2	BC-EAS-R-42-R	30546841	CP-EAS-R-N2-R	30508277
3	BC-EAS-R-43-B	30546844	CP-EAS-R-N3-B	30561492
3	BC-EAS-R-43-D	30498067	CP-EAS-R-N3-D	30561493
3	BC-EAS-R-43-F	30503115	CP-EAS-R-N3-F	30561494
3	BC-EAS-R-43-H	30503116	CP-EAS-R-N3-H	30561495
3	BC-EAS-R-43-K	30546845	CP-EAS-R-N3-K	30561496
3	BC-EAS-R-43-M	30546846	CP-EAS-R-N3-M	30561497
3	BC-EAS-R-43-P	30546848	CP-EAS-R-N3-P	30561498
3	BC-EAS-R-43-R	30546849	CP-EAS-R-N3-R	30561499



Wielkość ostrza HX	Kasety nożowe do systemu EasyAdjust		Dociski do systemu EasyAdjust	
	Specyfikacja	Nr materiałowy	Specyfikacja	Nr materiałowy
2	BC-EAS-R-62-B	30275903	CP-EAS-R-N2-B	30508276
2	BC-EAS-R-62-D	30410077	CP-EAS-R-N2-D	30561484
2	BC-EAS-R-62-F	30503094	CP-EAS-R-N2-F	30561485
2	BC-EAS-R-62-H	30503096	CP-EAS-R-N2-H	30561487
2	BC-EAS-R-62-K	30496821	CP-EAS-R-N2-K	30561488
2	BC-EAS-R-62-M	30471831	CP-EAS-R-N2-M	30561489
2	BC-EAS-R-62-P	30471833	CP-EAS-R-N2-P	30561490
2	BC-EAS-R-62-R	30496828	CP-EAS-R-N2-R	30508277
3	BC-EAS-R-63-B	30495992	CP-EAS-R-N3-B	30561492
3	BC-EAS-R-63-D	30469856	CP-EAS-R-N3-D	30561493
3	BC-EAS-R-63-F	30503097	CP-EAS-R-N3-F	30561494
3	BC-EAS-R-63-H	30503098	CP-EAS-R-N3-H	30561495
3	BC-EAS-R-63-K	30496827	CP-EAS-R-N3-K	30561496
3	BC-EAS-R-63-M	30471832	CP-EAS-R-N3-M	30561497
3	BC-EAS-R-63-P	30471834	CP-EAS-R-N3-P	30561498
3	BC-EAS-R-63-R	30496829	CP-EAS-R-N3-R	30561499

Zalecane parametry skrawania dla płytek skrawających HX

Posuw i prędkość skrawania

HX-HP342

MZG*	Materiał obrabiany	Wytrzymałość/twardość [N/mm ²] [HRC]	Prędkość cięcia v _c (m/min)		Posuw f _z (mm/z)	
			Chłodzenie wewnętrzne	Chłodzenie zewnętrzne		
P P1	P1.1	Stale konstrukcyjne, użytkowe i uszlachetnione, stale niestopowe	< 700	80	40	0,150
	P1.2	Stale konstrukcyjne, użytkowe i uszlachetnione, stale niestopowe	< 1200	70	35	0,150

HX-HP122

MZG*	Materiał obrabiany	Wytrzymałość/twardość [N/mm ²] [HRC]	Prędkość cięcia v _c (m/min)		Posuw f _z (mm/z)	
			Chłodzenie wewnętrzne	Chłodzenie zewnętrzne		
P P2 P3 P5	P2.1	Stale azotowane, użytkowe i uszlachetnione, stale stopowe	< 900	100	50	0,150
	P2.2	Stale azotowane, użytkowe i uszlachetnione, stale stopowe	< 1400	80	40	0,150
	P3.1	Stale narzędziowe, łożyskowe, sprężynowe i stale szybko tnące**	< 900	100	50	0,150
	P3.2	Stale narzędziowe, łożyskowe, sprężynowe i stale szybko tnące**	< 1500	80	40	0,150
	P5.1	Staliwo		80	40	0,150

HX-HP018

MZG*	Materiał obrabiany	Wytrzymałość/twardość [N/mm ²] [HRC]	Prędkość cięcia v _c (m/min)		Posuw f _z (mm/z)	
			Chłodzenie wewnętrzne	Chłodzenie zewnętrzne		
P4 P6	P4.1	Stale nierdzewne, ferrytyczne i martenzytyczne		50	25	0,120
	P6.1	Staliwo nierdzewne, ferrytyczne i martenzytyczne		40	20	0,120
M M1 M2 M3	M1.1	Stale nierdzewne, austenityczne	< 700	50	25	0,120
	M1.2	Stale nierdzewne, ferrytyczne/austenityczne (Duplex)	< 1000	30	15	0,120
	M2.1	Staliwo nierdzewne, austenityczne	< 700	50	25	0,120
	M3.1	Staliwo nierdzewne, ferrytyczne/austenityczne (Duplex)	< 1000	30	15	0,120

HX-HC419

MZG*	Materiał obrabiany	Wytrzymałość/twardość [N/mm ²] [HRC]	Prędkość cięcia v _c (m/min)		Posuw f _z (mm/z)	
			Chłodzenie wewnętrzne	Chłodzenie zewnętrzne		
K K1	K1.1	Żeliwo z grafitem płatkowym (żeliwo szare), GJL	< 300	110	55	0,150

* Grupa materiałowa wg MAPAL

** Jeśli składniki stopu Cr, Mo, Ni, V, W wynoszą łącznie > 8%, należy wybrać następną w kolejności grupę materiałową MAPAL.

HX-HP122

MZG*	Materiał obrabiany	Wytrzymałość/twardość [N/mm ²] [HRC]	Prędkość cięcia v _c (m/min)		Posuw f _z (mm/z)	
			Chłodzenie wewnętrzne	Chłodzenie zewnętrzne		
K2	K2.1	Żeliwo sferoidalne, GJS	< 500	100	50	0,150
	K2.2	Żeliwo sferoidalne, GJS	≤ 800	90	45	0,150
	K2.3	Żeliwo sferoidalne, GJS	> 800	80	40	0,150
K3	K3.1	Żeliwo wermikularne, GJV, (żeliwo ciągliwe), GJL	< 500	70	35	0,150
	K3.2	Żeliwo wermikularne, GJV, (żeliwo ciągliwe), GJL	> 500	70	35	0,150

HX-HP612

MZG*	Materiał obrabiany	Wytrzymałość/twardość [N/mm ²] [HRC]	Prędkość cięcia v _c (m/min)		Posuw f _z (mm/z)	
			Chłodzenie wewnętrzne	Chłodzenie zewnętrzne		
N N1	N1.1	Aluminium, niestopowe i stopowe < 3 % Si		160	80	0,150
	N1.2	Aluminium, stopowe ≤ 7 % Si		160	80	0,150

HX-HU612

MZG*	Materiał obrabiany	Wytrzymałość/twardość [N/mm ²] [HRC]	Prędkość cięcia v _c (m/min)		Posuw f _z (mm/z)	
			Chłodzenie wewnętrzne	Chłodzenie zewnętrzne		
N N2	N2.1	Miedź, niestopowa i niskostopowa	< 300	100	50	0,150
	N2.2	Miedź, stopowa	> 300	100	50	0,150
	N2.3	Mosiądz, brąz, spiż	< 1200	100	50	0,150
S S1 S2	S1.1	Tytan, stopy tytanu	< 400	30	15	0,120
	S2.1	Tytan, stopy tytanu	< 1200	20	10	0,120
	S2.2	Tytan, stopy tytanu	> 1200	20	10	0,100

HX-HP018

MZG*	Materiał obrabiany	Wytrzymałość/twardość [N/mm ²] [HRC]	Prędkość cięcia v _c (m/min)		Posuw f _z (mm/z)
			Chłodzenie wewnętrzne	Chłodzenie zewnętrzne	
H H1 H1.1	Stal utwardzana/staliwo	45 - 55	30	15	0,120

Podane parametry skrawania to wartości orientacyjne.

Optymalne wartości dla danego przypadku obróbki należy ustalić w ramach próby lub podczas obróbki.

Zalecane parametry skrawania dla płytek skrawających HX

Posuw i prędkość skrawania

HX-CP122

MZG*	Materiał obrabiany	Wytrzymałość/twardość [N/mm ²] [HRC]	Prędkość cięcia v_c (m/min)		Posuw f_z (mm/z)	
			Chłodzenie wewnętrzne	Chłodzenie zewnętrzne		
P	P1	P1.1 Stale konstrukcyjne, użytkowe i uszlachetnione, stale niestopowe	< 700	180	90	0,150
		P1.2 Stale konstrukcyjne, użytkowe i uszlachetnione, stale niestopowe	< 1200	160	80	0,120
	P2	P2.1 Stale azotowane, użytkowe i uszlachetnione, stale stopowe	< 900	160	80	0,150
		P2.2 Stale azotowane, użytkowe i uszlachetnione, stale stopowe	< 1400	140	70	0,120
	P3	P3.1 Stale narzędziowe, łożyskowe, sprężynowe i stale szybko tnące**	< 800	160	80	0,150
		P3.2 Stale narzędziowe, łożyskowe, sprężynowe i stale szybko tnące**	< 1000	160	80	0,150
		P3.3 Stale narzędziowe, łożyskowe, sprężynowe i stale szybko tnące**	< 1500	140	70	0,120
	P5	P5.1 Staliwo		140	70	0,120

HX-PU620

MZG*	Materiał obrabiany	Wytrzymałość/twardość [N/mm ²] [HRC]	Prędkość cięcia v_c (m/min)		Posuw f_z (mm/z)	
			Chłodzenie wewnętrzne	Chłodzenie zewnętrzne		
N	N1	N1.1 Aluminium, niestopowe i stopowe < 3 % Si		230	115	0,150
		N1.2 Aluminium, stopowe ≤ 7 % Si		230	115	0,150
		N1.3 Aluminium, stopowe > 7-12 % Si		230	115	0,150
		N1.4 Aluminium, stopowe > 12 % Si		230	115	0,150
N2	N2.1 Miedź, niestopowa i niskostopowa	< 300	180	90	0,150	
	N2.2 Miedź, stopowa	> 300	180	90	0,150	
	N2.3 Mosiądz, brąz, spiż	< 1200	180	90	0,150	

HX-FU485

MZG*	Materiał obrabiany	Wytrzymałość/twardość [N/mm ²] [HRC]	Prędkość cięcia v_c (m/min)		Posuw f_z (mm/z)
			Chłodzenie wewnętrzne	Chłodzenie zewnętrzne	
K K1	K1.1 Żeliwo z grafitem płatkowym (żeliwo szare), GJL	< 300	150	75	0,150

HX-FU801

MZG*	Materiał obrabiany	Wytrzymałość/twardość [N/mm ²] [HRC]	Prędkość cięcia v_c (m/min)		Posuw f_z (mm/z)
			Chłodzenie wewnętrzne	Chłodzenie zewnętrzne	
H H1	H1.1 Stal utwardzana/staliwo	45 - 55	60	30	0,100
	H1.2 Stal utwardzana/staliwo	55 - 64	50	25	0,080

* Grupa materiałowa wg MAPAL

** Jeśli składniki stopu Cr, Mo, Ni, V, W wynoszą łącznie > 8%, należy wybrać następną w kolejności grupę materiałową MAPAL.

Zalecane parametry skrawania dla płytek skrawających TEC

Posuw i prędkość skrawania

TEC2-AS-HP115

MZG*	Materiał obrabiany	Wytrzymałość/twardość [N/mm ²] [HRC]	Prędkość cięcia v _c (m/min)		Posuw f _z (mm/z)	
			Chłodzenie wewnętrzne	Chłodzenie zewnętrzne		
P P1	P1.1	Stale konstrukcyjne, użytkowe i uszlachetnione, stale niestopowe	< 700	80	40	0,150
	P1.2	Stale konstrukcyjne, użytkowe i uszlachetnione, stale niestopowe	< 1200	70	35	0,150

TEC2-EK-HP115

MZG*	Materiał obrabiany	Wytrzymałość/twardość [N/mm ²] [HRC]	Prędkość cięcia v _c (m/min)		Posuw f _z (mm/z)	
			Chłodzenie wewnętrzne	Chłodzenie zewnętrzne		
P P1	P1.1	Stale konstrukcyjne, użytkowe i uszlachetnione, stale niestopowe	< 700 N/mm ²	80	40	0,150
	P1.2	Stale konstrukcyjne, użytkowe i uszlachetnione, stale niestopowe	< 1200 N/mm ²	70	35	0,150

TEC2-DZ-HP115

MZG*	Materiał obrabiany	Wytrzymałość/twardość [N/mm ²] [HRC]	Prędkość cięcia v _c (m/min)		Posuw f _z (mm/z)	
			Chłodzenie wewnętrzne	Chłodzenie zewnętrzne		
P P1	P1.1	Stale konstrukcyjne, użytkowe i uszlachetnione, stale niestopowe	< 700	80	40	0,150
	P1.2	Stale konstrukcyjne, użytkowe i uszlachetnione, stale niestopowe	< 1200	70	35	0,150

TEC2-04-HP115

MZG*	Materiał obrabiany	Wytrzymałość/twardość [N/mm ²] [HRC]	Prędkość cięcia v _c (m/min)		Posuw f _z (mm/z)	
			Chłodzenie wewnętrzne	Chłodzenie zewnętrzne		
P P1	P1.1	Stale konstrukcyjne, użytkowe i uszlachetnione, stale niestopowe	< 700	80	40	0,150
	P1.2	Stale konstrukcyjne, użytkowe i uszlachetnione, stale niestopowe	< 1200	70	35	0,150

TEC2-AS-HP425

MZG*	Materiał obrabiany	Wytrzymałość/twardość [N/mm ²] [HRC]	Prędkość cięcia v _c (m/min)		Posuw f _z (mm/z)	
			Chłodzenie wewnętrzne	Chłodzenie zewnętrzne		
P P2 P3 P5	P2.1	Stale azotowane, użytkowe i uszlachetnione, stale stopowe	< 900	100	50	0,150
	P2.2	Stale azotowane, użytkowe i uszlachetnione, stale stopowe	< 1400	80	40	0,150
	P3.1	Stale narzędziowe, łożyskowe, sprężynowe i stale szybkołotne**	< 900	100	50	0,150
	P3.2	Stale narzędziowe, łożyskowe, sprężynowe i stale szybkołotne**	< 1500	80	40	0,150
	P5.1	Staliwo		80	40	0,150

Podane parametry skrawania to wartości orientacyjne.

Optymalne wartości dla danego przypadku obróbki należy ustalić w ramach próby lub podczas obróbki.

Zalecane parametry skrawania dla płytek skrawających TEC

Posuw i prędkość skrawania

TEC2-EK-HP425

MZG*	Materiał obrabiany	Wytrzymałość/twardość [N/mm ²] [HRC]	Prędkość cięcia v_c (m/min)		Posuw f_z (mm/z)	
			Chłodzenie wewnętrzne	Chłodzenie zewnętrzne		
P	P2.1	Stale azotowane, użytkowe i uszlachetnione, stale stopowe	< 900	100	50	0,150
	P2.2	Stale azotowane, użytkowe i uszlachetnione, stale stopowe	< 1400	80	40	0,150
	P3.1	Stale narzędziowe, łożyskowe, sprężynowe i stale szybkoobrotowe**	< 900	100	50	0,150
	P3.2	Stale narzędziowe, łożyskowe, sprężynowe i stale szybkoobrotowe**	< 1500	80	40	0,150
	P5.1	Staliwo		80	40	0,150

TEC2-DZ-HP425

MZG*	Materiał obrabiany	Wytrzymałość/twardość [N/mm ²] [HRC]	Prędkość cięcia v_c (m/min)		Posuw f_z (mm/z)	
			Chłodzenie wewnętrzne	Chłodzenie zewnętrzne		
P	P2.1	Stale azotowane, użytkowe i uszlachetnione, stale stopowe	< 900	100	50	0,150
	P2.2	Stale azotowane, użytkowe i uszlachetnione, stale stopowe	< 1400	80	40	0,150
	P3.1	Stale narzędziowe, łożyskowe, sprężynowe i stale szybkoobrotowe**	< 900	100	50	0,150
	P3.2	Stale narzędziowe, łożyskowe, sprężynowe i stale szybkoobrotowe**	< 1500	80	40	0,150
	P5.1	Staliwo		80	40	0,150

TEC2-04-HP425

MZG*	Materiał obrabiany	Wytrzymałość/twardość [N/mm ²] [HRC]	Prędkość cięcia v_c (m/min)		Posuw f_z (mm/z)	
			Chłodzenie wewnętrzne	Chłodzenie zewnętrzne		
P	P2.1	Stale azotowane, użytkowe i uszlachetnione, stale stopowe	< 900	100	50	0,150
	P2.2	Stale azotowane, użytkowe i uszlachetnione, stale stopowe	< 1400	80	40	0,150
	P3.1	Stale narzędziowe, łożyskowe, sprężynowe i stale szybkoobrotowe**	< 900	100	50	0,150
	P3.2	Stale narzędziowe, łożyskowe, sprężynowe i stale szybkoobrotowe**	< 1500	80	40	0,150
	P5.1	Staliwo		80	40	0,150

TEC2-AS-HP016

MZG*	Materiał obrabiany	Wytrzymałość/twardość [N/mm ²] [HRC]	Prędkość cięcia v_c (m/min)		Posuw f_z (mm/z)	
			Chłodzenie wewnętrzne	Chłodzenie zewnętrzne		
P	P4.1	Stale nierdzewne, ferrytyczne i martenzytyczne	50	25	0,120	
	P6.1	Staliwo nierdzewne, ferrytyczne i martenzytyczne	40	20	0,120	
M	M1.1	Stale nierdzewne, austenityczne	< 700	50	25	0,120
	M1.2	Stale nierdzewne, ferrytyczne/austenityczne (Duplex)	< 1000	30	15	0,120
	M2.1	Staliwo nierdzewne, austenityczne	< 700	50	25	0,120
M3	M3.1	Staliwo nierdzewne, ferrytyczne/austenityczne (Duplex)	< 1000	30	15	0,120

* Grupa materiałowa wg MAPAL

** Jeśli składniki stopu Cr, Mo, Ni, V, W wynoszą łącznie > 8%, należy wybrać następną w kolejności grupę materiałową MAPAL.

TEC2-EK-HP016

MZG*	Materiał obrabiany	Wytrzymałość/twardość [N/mm ²] [HRC]	Prędkość cięcia v _c (m/min)		Posuw f _z (mm/z)		
			Chłodzenie wewnętrzne	Chłodzenie zewnętrzne			
P4	P4.1	Stale nierdzewne, ferrytyczne i martenzytyczne	50	25	0,120		
P6	P6.1	Staliwo nierdzewne, ferrytyczne i martenzytyczne	40	20	0,120		
M	M1	M1.1	Stale nierdzewne, austenityczne	< 700	50	25	0,120
		M1.2	Stale nierdzewne, ferrytyczne/austenityczne (Duplex)	< 1000	30	15	0,120
	M2	M2.1	Staliwo nierdzewne, austenityczne	< 700	50	25	0,120
	M3	M3.1	Staliwo nierdzewne, ferrytyczne/austenityczne (Duplex)	< 1000	30	15	0,120

TEC2-DZ-HP016

MZG*	Materiał obrabiany	Wytrzymałość/twardość [N/mm ²] [HRC]	Prędkość cięcia v _c (m/min)		Posuw f _z (mm/z)		
			Chłodzenie wewnętrzne	Chłodzenie zewnętrzne			
P4	P4.1	Stale nierdzewne, ferrytyczne i martenzytyczne	50	25	0,120		
P6	P6.1	Staliwo nierdzewne, ferrytyczne i martenzytyczne	40	20	0,120		
M	M1	M1.1	Stale nierdzewne, austenityczne	< 700	50	25	0,120
		M1.2	Stale nierdzewne, ferrytyczne/austenityczne (Duplex)	< 1000	30	15	0,120
	M2	M2.1	Staliwo nierdzewne, austenityczne	< 700	50	25	0,120
	M3	M3.1	Staliwo nierdzewne, ferrytyczne/austenityczne (Duplex)	< 1000	30	15	0,120

TEC2-04-HP016

MZG*	Materiał obrabiany	Wytrzymałość/twardość [N/mm ²] [HRC]	Prędkość cięcia v _c (m/min)		Posuw f _z (mm/z)		
			Chłodzenie wewnętrzne	Chłodzenie zewnętrzne			
P4	P4.1	Stale nierdzewne, ferrytyczne i martenzytyczne	50	25	0,120		
P6	P6.1	Staliwo nierdzewne, ferrytyczne i martenzytyczne	40	20	0,120		
M	M1	M1.1	Stale nierdzewne, austenityczne	< 700	50	25	0,120
		M1.2	Stale nierdzewne, ferrytyczne/austenityczne (Duplex)	< 1000	30	15	0,120
	M2	M2.1	Staliwo nierdzewne, austenityczne	< 700	50	25	0,120
	M3	M3.1	Staliwo nierdzewne, ferrytyczne/austenityczne (Duplex)	< 1000	30	15	0,120

TEC2-DZ-HC418

MZG*	Materiał obrabiany	Wytrzymałość/twardość [N/mm ²] [HRC]	Prędkość cięcia v _c (m/min)		Posuw f _z (mm/z)		
			Chłodzenie wewnętrzne	Chłodzenie zewnętrzne			
K	K1	K1.1	Żeliwo z grafitem płatkowym (żeliwo szare), GJL	< 300	100	50	0,150

Podane parametry skrawania to wartości orientacyjne.

Optymalne wartości dla danego przypadku obróbki należy ustalić w ramach próby lub podczas obróbki.

Zalecane parametry skrawania dla płytek skrawających TEC

Posuw i prędkość skrawania

TEC2-04-HC418

MZG*	Materiał obrabiany	Wytrzymałość/twardość [N/mm ²] [HRC]	Prędkość cięcia v_c (m/min)		Posuw f_z (mm/z)
			Chłodzenie wewnętrzne	Chłodzenie zewnętrzne	
K K1	K1.1 Żeliwo z grafitem płatkowym (żeliwo szare), GJL	< 300	100	50	0,150

TEC2-DZ-HP426

MZG*	Materiał obrabiany	Wytrzymałość/twardość [N/mm ²] [HRC]	Prędkość cięcia v_c (m/min)		Posuw f_z (mm/z)
			Chłodzenie wewnętrzne	Chłodzenie zewnętrzne	
K2	K2.1 Żeliwo sferoidalne, GJS	< 500	100	50	0,150
	K2.2 Żeliwo sferoidalne, GJS	≤ 800	90	45	0,150
	K2.3 Żeliwo sferoidalne, GJS	> 800	80	40	0,150
K3	K3.1 Żeliwo wermikularne, GJV, (żeliwo ciągliwe), GJL	< 500	70	35	0,150
	K3.2 Żeliwo wermikularne, GJV, (żeliwo ciągliwe), GJL	> 500	70	35	0,150

TEC2-04-HP426

MZG*	Materiał obrabiany	Wytrzymałość/twardość [N/mm ²] [HRC]	Prędkość cięcia v_c (m/min)		Posuw f_z (mm/z)
			Chłodzenie wewnętrzne	Chłodzenie zewnętrzne	
K2	K2.1 Żeliwo sferoidalne, GJS	< 500	100	50	0,150
	K2.2 Żeliwo sferoidalne, GJS	≤ 800	90	45	0,150
	K2.3 Żeliwo sferoidalne, GJS	> 800	80	40	0,150
K3	K3.1 Żeliwo wermikularne, GJV, (żeliwo ciągliwe), GJL	< 500	70	35	0,150
	K3.2 Żeliwo wermikularne, GJV, (żeliwo ciągliwe), GJL	> 500	70	35	0,150

TEC2-AS-HP612

MZG*	Materiał obrabiany	Wytrzymałość/twardość [N/mm ²] [HRC]	Prędkość cięcia v_c (m/min)		Posuw f_z (mm/z)
			Chłodzenie wewnętrzne	Chłodzenie zewnętrzne	
N N1	N1.1 Aluminium, niestopowe i stopowe < 3 % Si		160	80	0,150
	N1.2 Aluminium, stopowe ≤ 7 % Si		160	80	0,150

TEC2-EK-HP612

MZG*	Materiał obrabiany	Wytrzymałość/twardość [N/mm ²] [HRC]	Prędkość cięcia v_c (m/min)		Posuw f_z (mm/z)
			Chłodzenie wewnętrzne	Chłodzenie zewnętrzne	
N N1	N1.1 Aluminium, niestopowe i stopowe < 3 % Si		160	80	0,150
	N1.2 Aluminium, stopowe ≤ 7 % Si		160	80	0,150

TEC2-DZ-HP612

MZG*	Materiał obrabiany	Wytrzymałość/twardość [N/mm ²] [HRC]	Prędkość cięcia v _c (m/min)		Posuw f _z (mm/z)
			Chłodzenie wewnętrzne	Chłodzenie zewnętrzne	
N N1	N1.1 Aluminium, niestopowe i stopowe < 3 % Si		160	80	0,150
	N1.2 Aluminium, stopowe ≤ 7 % Si		160	80	0,150

TEC2-04-HP612

MZG*	Materiał obrabiany	Wytrzymałość/twardość [N/mm ²] [HRC]	Prędkość cięcia v _c (m/min)		Posuw f _z (mm/z)
			Chłodzenie wewnętrzne	Chłodzenie zewnętrzne	
N N1	N1.1 Aluminium, niestopowe i stopowe < 3 % Si		160	80	0,150
	N1.2 Aluminium, stopowe ≤ 7 % Si		160	80	0,150

TEC2-AS-HU615

MZG*	Materiał obrabiany	Wytrzymałość/twardość [N/mm ²] [HRC]	Prędkość cięcia v _c (m/min)		Posuw f _z (mm/z)
			Chłodzenie wewnętrzne	Chłodzenie zewnętrzne	
N N2	N2.1 Miedź, niestopowa i niskostopowa	< 300	100	50	0,150
	N2.2 Miedź, stopowa	> 300	100	50	0,150
	N2.3 Mosiądz, brąz, spiż	< 1200	100	50	0,150
S S1	S1.1 Tytan, stopy tytanu	< 400	30	15	0,120
	S2.1 Tytan, stopy tytanu	< 1200	20	10	0,120
	S2.2 Tytan, stopy tytanu	> 1200	20	10	0,100

TEC2-EK-HU615

MZG*	Materiał obrabiany	Wytrzymałość/twardość [N/mm ²] [HRC]	Prędkość cięcia v _c (m/min)		Posuw f _z (mm/z)
			Chłodzenie wewnętrzne	Chłodzenie zewnętrzne	
N N2	N2.1 Miedź, niestopowa i niskostopowa	< 300	100	50	0,150
	N2.2 Miedź, stopowa	> 300	100	50	0,150
	N2.3 Mosiądz, brąz, spiż	< 1200	100	50	0,150
S S1	S1.1 Tytan, stopy tytanu	< 400	30	15	0,120
	S2.1 Tytan, stopy tytanu	< 1200	20	10	0,120
	S2.2 Tytan, stopy tytanu	> 1200	20	10	0,100

Podane parametry skrawania to wartości orientacyjne.

Optymalne wartości dla danego przypadku obróbki należy ustalić w ramach próby lub podczas obróbki.

Zalecane parametry skrawania dla płytek skrawających TEC

Posuw i prędkość skrawania

TEC2-DZ-HU615

MZG*			Materiał obrabiany	Wytrzymałość/twardość [N/mm ²] [HRC]	Prędkość cięcia v_c (m/min)		Posuw f_z (mm/z)
					Chłodzenie wewnętrzne	Chłodzenie zewnętrzne	
N	N2	N2.1	Miedź, niestopowa i niskostopowa	< 300	100	50	0,150
		N2.2	Miedź, stopowa	> 300	100	50	0,150
		N2.3	Mosiądz, brąz, spiż	< 1200	100	50	0,150
S	S1	S1.1	Tytan, stopy tytanu	< 400	30	15	0,120
		S2.1	Tytan, stopy tytanu	< 1200	20	10	0,120
		S2.2	Tytan, stopy tytanu	> 1200	20	10	0,100

TEC2-04-HU615

MZG*			Materiał obrabiany	Wytrzymałość/twardość [N/mm ²] [HRC]	Prędkość cięcia v_c (m/min)		Posuw f_z (mm/z)
					Chłodzenie wewnętrzne	Chłodzenie zewnętrzne	
N	N2	N2.1	Miedź, niestopowa i niskostopowa	< 300	100	50	0,150
		N2.2	Miedź, stopowa	> 300	100	50	0,150
		N2.3	Mosiądz, brąz, spiż	< 1200	100	50	0,150
S	S1	S1.1	Tytan, stopy tytanu	< 400	30	15	0,120
		S2.1	Tytan, stopy tytanu	< 1200	20	10	0,120
		S2.2	Tytan, stopy tytanu	> 1200	20	10	0,100

TEC2-DZ-HP016

MZG*			Materiał obrabiany	Wytrzymałość/twardość [N/mm ²] [HRC]	Prędkość cięcia v_c (m/min)		Posuw f_z (mm/z)
					Chłodzenie wewnętrzne	Chłodzenie zewnętrzne	
H	H1	H1.1	Stal utwardzana/staliwo	45 - 55	30	15	0,120

TEC2-04-HP016

MZG*			Materiał obrabiany	Wytrzymałość/twardość [N/mm ²] [HRC]	Prędkość cięcia v_c (m/min)		Posuw f_z (mm/z)
					Chłodzenie wewnętrzne	Chłodzenie zewnętrzne	
H	H1	H1.1	Stal utwardzana/staliwo	45 - 55	30	15	0,120

* Grupa materiałowa wg MAPAL

** Jeśli składniki stopu Cr, Mo, Ni, V, W wynoszą łącznie > 8%, należy wybrać następną w kolejności grupę materiałową MAPAL.

TEC2-AS-CP122

MZG*	Materiał obrabiany	Wytrzymałość/twardość [N/mm ²] [HRC]	Prędkość cięcia v _c (m/min)		Posuw f _z (mm/z)		
			Chłodzenie wewnętrzne	Chłodzenie zewnętrzne			
P	P1	P1.1	Stale konstrukcyjne, użytkowe i uszlachetnione, stale niestopowe	< 700	180	90	0,150
		P1.2	Stale konstrukcyjne, użytkowe i uszlachetnione, stale niestopowe	< 1200	160	80	0,120
	P2	P2.1	Stale azotowane, użytkowe i uszlachetnione, stale stopowe	< 900	160	80	0,150
		P2.2	Stale azotowane, użytkowe i uszlachetnione, stale stopowe	< 1400	140	70	0,120
	P3	P3.1	Stale narzędziowe, łożyskowe, sprężynowe i stale szybko tnące**	< 800	160	80	0,150
		P3.2	Stale narzędziowe, łożyskowe, sprężynowe i stale szybko tnące**	< 1000	160	80	0,150
		P3.3	Stale narzędziowe, łożyskowe, sprężynowe i stale szybko tnące**	< 1500	140	70	0,120
	P5	P5.1	Staliwo		140	70	0,120

TEC2-EK-CP122

MZG*	Materiał obrabiany	Wytrzymałość/twardość [N/mm ²] [HRC]	Prędkość cięcia v _c (m/min)		Posuw f _z (mm/z)		
			Chłodzenie wewnętrzne	Chłodzenie zewnętrzne			
P	P1	P1.1	Stale konstrukcyjne, użytkowe i uszlachetnione, stale niestopowe	< 700	180	90	0,150
		P1.2	Stale konstrukcyjne, użytkowe i uszlachetnione, stale niestopowe	< 1200	160	80	0,120
	P2	P2.1	Stale azotowane, użytkowe i uszlachetnione, stale stopowe	< 900	160	80	0,150
		P2.2	Stale azotowane, użytkowe i uszlachetnione, stale stopowe	< 1400	140	70	0,120
	P3	P3.1	Stale narzędziowe, łożyskowe, sprężynowe i stale szybko tnące**	< 800	160	80	0,150
		P3.2	Stale narzędziowe, łożyskowe, sprężynowe i stale szybko tnące**	< 1000	160	80	0,150
		P3.3	Stale narzędziowe, łożyskowe, sprężynowe i stale szybko tnące**	< 1500	140	70	0,120
	P5	P5.1	Staliwo		140	70	0,120

TEC2-DZ-CP122

MZG*	Materiał obrabiany	Wytrzymałość/twardość [N/mm ²] [HRC]	Prędkość cięcia v _c (m/min)		Posuw f _z (mm/z)		
			Chłodzenie wewnętrzne	Chłodzenie zewnętrzne			
P	P1	P1.1	Stale konstrukcyjne, użytkowe i uszlachetnione, stale niestopowe	< 700	180	90	0,150
		P1.2	Stale konstrukcyjne, użytkowe i uszlachetnione, stale niestopowe	< 1200	160	80	0,120
	P2	P2.1	Stale azotowane, użytkowe i uszlachetnione, stale stopowe	< 900	160	80	0,150
		P2.2	Stale azotowane, użytkowe i uszlachetnione, stale stopowe	< 1400	140	70	0,120
	P3	P3.1	Stale narzędziowe, łożyskowe, sprężynowe i stale szybko tnące**	< 800	160	80	0,150
		P3.2	Stale narzędziowe, łożyskowe, sprężynowe i stale szybko tnące**	< 1000	160	80	0,150
		P3.3	Stale narzędziowe, łożyskowe, sprężynowe i stale szybko tnące**	< 1500	140	70	0,120
	P5	P5.1	Staliwo		140	70	0,120

Podane parametry skrawania to wartości orientacyjne.

Optymalne wartości dla danego przypadku obróbki należy ustalić w ramach próby lub podczas obróbki.

Zalecane parametry skrawania dla płytek skrawających TEC

Posuw i prędkość skrawania

TEC2-04-CP122

MZG*	Materiał obrabiany	Wytrzymałość/twardość [N/mm ²] [HRC]	Prędkość cięcia v_c (m/min)		Posuw f_z (mm/z)	
			Chłodzenie wewnętrzne	Chłodzenie zewnętrzne		
P1	P1.1	Stale konstrukcyjne, użytkowe i uszlachetnione, stale niestopowe	< 700	180	90	0,150
	P1.2	Stale konstrukcyjne, użytkowe i uszlachetnione, stale niestopowe	< 1200	160	80	0,120
P2	P2.1	Stale azotowane, użytkowe i uszlachetnione, stale stopowe	< 900	160	80	0,150
	P2.2	Stale azotowane, użytkowe i uszlachetnione, stale stopowe	< 1400	140	70	0,120
P3	P3.1	Stale narzędziowe, łożyskowe, sprężynowe i stale szybko tnące**	< 800	160	80	0,150
	P3.2	Stale narzędziowe, łożyskowe, sprężynowe i stale szybko tnące**	< 1000	160	80	0,150
	P3.3	Stale narzędziowe, łożyskowe, sprężynowe i stale szybko tnące**	< 1500	140	70	0,120
P5	P5.1	Staliwo		140	70	0,120

TEC2-AS-PU620

MZG*	Materiał obrabiany	Wytrzymałość/twardość [N/mm ²] [HRC]	Prędkość cięcia v_c (m/min)		Posuw f_z (mm/z)	
			Chłodzenie wewnętrzne	Chłodzenie zewnętrzne		
N1	N1.1	Aluminium, niestopowe i stopowe < 3 % Si		230	115	0,150
	N1.2	Aluminium, stopowe ≤ 7 % Si		230	115	0,150
	N1.3	Aluminium, stopowe > 7-12 % Si		230	115	0,150
	N1.4	Aluminium, stopowe > 12 % Si		230	115	0,150
N2	N2.1	Miedź, niestopowa i niskostopowa	< 300	180	90	0,150
	N2.2	Miedź, stopowa	> 300	180	90	0,150
	N2.3	Mosiądz, brąz, spiż	< 1200	180	90	0,150

TEC2-EK-PU620

MZG*	Materiał obrabiany	Wytrzymałość/twardość [N/mm ²] [HRC]	Prędkość cięcia v_c (m/min)		Posuw f_z (mm/z)	
			Chłodzenie wewnętrzne	Chłodzenie zewnętrzne		
N1	N1.1	Aluminium, niestopowe i stopowe < 3 % Si		230	115	0,150
	N1.2	Aluminium, stopowe ≤ 7 % Si		230	115	0,150
	N1.3	Aluminium, stopowe > 7-12 % Si		230	115	0,150
	N1.4	Aluminium, stopowe > 12 % Si		230	115	0,150
N2	N2.1	Miedź, niestopowa i niskostopowa	< 300	180	90	0,150
	N2.2	Miedź, stopowa	> 300	180	90	0,150
	N2.3	Mosiądz, brąz, spiż	< 1200	180	90	0,150

* Grupa materiałowa wg MAPAL

** Jeśli składniki stopu Cr, Mo, Ni, V, W wynoszą łącznie > 8%, należy wybrać następną w kolejności grupę materiałową MAPAL.

TEC2-DZ-PU620

MZG*	Materiał obrabiany	Wytrzymałość/twardość [N/mm ²] [HRC]	Prędkość cięcia v _c (m/min)		Posuw f _z (mm/z)	
			Chłodzenie wewnętrzne	Chłodzenie zewnętrzne		
N	N1	N1.1 Aluminium, niestopowe i stopowe < 3 % Si		230	115	0,150
		N1.2 Aluminium, stopowe ≤ 7 % Si		230	115	0,150
		N1.3 Aluminium, stopowe > 7-12 % Si		230	115	0,150
		N1.4 Aluminium, stopowe > 12 % Si		230	115	0,150
N	N2	N2.1 Miedź, niestopowa i niskostopowa	< 300	180	90	0,150
		N2.2 Miedź, stopowa	> 300	180	90	0,150
		N2.3 Mosiądz, brąz, spiż	< 1200	180	90	0,150

TEC2-04-PU620

MZG*	Materiał obrabiany	Wytrzymałość/twardość [N/mm ²] [HRC]	Prędkość cięcia v _c (m/min)		Posuw f _z (mm/z)	
			Chłodzenie wewnętrzne	Chłodzenie zewnętrzne		
N	N1	N1.1 Aluminium, niestopowe i stopowe < 3 % Si		230	115	0,150
		N1.2 Aluminium, stopowe ≤ 7 % Si		230	115	0,150
		N1.3 Aluminium, stopowe > 7-12 % Si		230	115	0,150
		N1.4 Aluminium, stopowe > 12 % Si		230	115	0,150
N	N2	N2.1 Miedź, niestopowa i niskostopowa	< 300	180	90	0,150
		N2.2 Miedź, stopowa	> 300	180	90	0,150
		N2.3 Mosiądz, brąz, spiż	< 1200	180	90	0,150

Podane parametry skrawania to wartości orientacyjne.

Optymalne wartości dla danego przypadku obróbki należy ustalić w ramach próby lub podczas obróbki.

Zalecane parametry skrawania dla płytek skrawających TEC

Posuw i prędkość skrawania

TEC2-DZ-FU485

MZG*	Materiał obrabiany	Wytrzymałość/twardość [N/mm ²] [HRC]	Prędkość cięcia v_c (m/min)		Posuw f_z (mm/z)
			Chłodzenie wewnętrzne	Chłodzenie zewnętrzne	
K K1 K1.1	Żeliwo z grafitem płatkowym (żeliwo szare), GJL	< 300	150	75	0,150

TEC2-04-FU485

MZG*	Materiał obrabiany	Wytrzymałość/twardość [N/mm ²] [HRC]	Prędkość cięcia v_c (m/min)		Posuw f_z (mm/z)
			Chłodzenie wewnętrzne	Chłodzenie zewnętrzne	
K K1 K1.1	Żeliwo z grafitem płatkowym (żeliwo szare), GJL	< 300	150	75	0,150

TEC2-DZ-FU801

MZG*		Materiał obrabiany	Wytrzymałość/twardość [N/mm ²] [HRC]	Prędkość cięcia v_c (m/min)		Posuw f_z (mm/z)	
				Chłodzenie wewnętrzne	Chłodzenie zewnętrzne		
H	H1	H1.1	Stal utwardzana/staliwo	45 - 55	60	30	0,100
	H1.2	Stal utwardzana/staliwo	55 - 64	50	25	0,080	

TEC2-04-FU801

MZG*		Materiał obrabiany	Wytrzymałość/twardość [N/mm ²] [HRC]	Prędkość cięcia v_c (m/min)		Posuw f_z (mm/z)	
				Chłodzenie wewnętrzne	Chłodzenie zewnętrzne		
H	H1	H1.1	Stal utwardzana/staliwo	45 - 55	60	30	0,100
		H1.2	Stal utwardzana/staliwo	55 - 64	50	25	0,080

Podane parametry skrawania to wartości orientacyjne.

Optymalne wartości dla danego przypadku obróbki należy ustalić w ramach próby lub podczas obróbki.



Łatwe prowadzenie rozwiercania zewnętrznego małych średnic

Firma MAPAL opracowała nowy system, który maksymalnie upraszcza ustawianie rozwiertaków zewnętrznych o małych średnicach. W tym celu w kasecie zintegrowano system EasyAdjust. Kasetę można wyjąć, aby szybko i łatwo wyregulować ostrze za pomocą śruby mikrometrycznej lub płytki pomiarowej.

W samym systemie EA pochylenie ostrza jest już zintegrowane w chwycie ostrza. Dzięki temu proces ustawiania pochylenia płytki zostaje całkowicie wyeliminowany. Wystarczy jedynie wyregulować występ ostrza w stosunku do listew prowadzących. Dzięki wysokiej dokładności przezbrajania i niezwykle prostej regulacji ostrza nowy system bardzo ułatwia osiągnięcie zgodności z wymaganymi tolerancjami w bardzo precyzyjnych dopasowaniach, nawet w zakresie małych średnic.

W SKRÓCIE

- Nowy system ułatwiający regulację procesu rozwiercania zewnętrznego małych średnic
- Kasecja systemu EA zintegrowana z kolejną, wymiową kasetą
- Wysoka dokładność przezbrajania (poniżej 2-3 μm)
- Możliwość szybkiej i łatwej regulacji ostrza
- Pochylenie ostrza jest ustawione wstępnie w kasecji, która pełni rolę chwytu do mocowania ostrza

ZALETY

- Wysoka ekonomiczność i stabilność procesu
- Zmniejszony nakład pracy związanej z regulacją dzięki innowacyjnemu systemowi „kasetta w kasecji”
- Łatwa obsługa
- Wyeliminowany proces ustawiania pochylenia płytki
- Stabilne zachowanie ścisłych tolerancji



Rozwiertak zewnętrzny z systemem EasyAdjust | Różnice między systemami

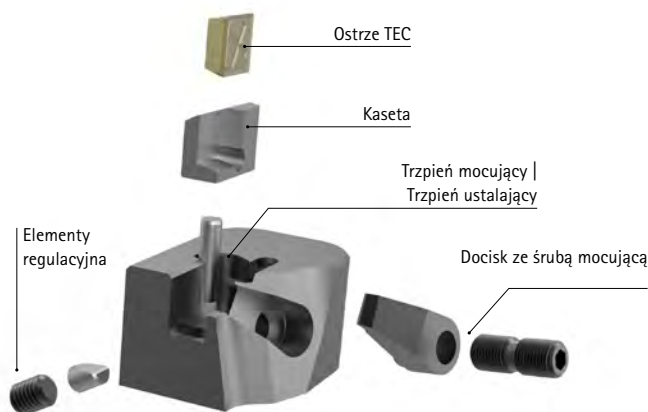

System EasyAdjust z płytą skrawającą TEC

- Wiele krawędzi skrawających (liczba krawędzi skrawających)
- Prosta obsługa
- Możliwość zastosowania ostrzy TEC2 i TEC3

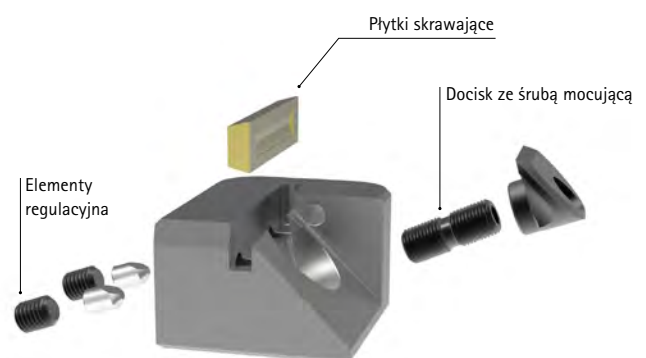

Płytki skrawające

- Wysokie wymagania dotyczące powierzchni, np. $< R_z 6$
- Specjalny kontur (płytki skrawające)
- Obróbka powierzchni czołowych
- Skrawanie czołowe z przejściem promieniowym

Płytki skrawające TEC do narzędzi do obróbki zewnętrznej

Materiał skrawający	Węglik spiekany									
MZG*	P				M	K	N			
	1.1 - 1.2	2 - 3 5	4 6	1 - 3	1.1	2 - 3	1.1 - 1.2	2.3	2.1 - 2.2	
Rodzaj materiału skrawającego	HP115	HP425	HP016	HP016	HC418	HP426	HP612	HU615		

Geometria kształtu wióra	Wielkość	Nacięcie	Specyfikacja	Nr materiałowy							
neutralny	2	AS	WP-TEC2-ASE02LOA-...								
		EK **	WP-TEC2-EKE02LOA-...								
		DZ	WP-TEC2-DZE02LOA-...				31306931				
		R0,4 **	WP-TEC2-04E02LOA-...				31306932				

dodatni	2	AS	WP-TEC2-ASF01L1G-...	31306933	30889440	31079651	31079651			31140267	
		EK **	WP-TEC2-EKF01L1G-...	30653470	30829191	30971023	30971023			30630537	
		DZ	WP-TEC2-DZF01L1G-...	31306937	31306938	31306940	31306940		31306941	31181002	
		R0,4 **	WP-TEC2-04F01L1J-...	31306945	31306947	31306949	31306949		31306950	31306951	

wysoki dodatni	2	AS	WP-TEC2-ASF01L1N-...						31306973	31306974
		EK **	WP-TEC2-EKF01L1N-...						31306977	31306978
		DZ	WP-TEC2-DZF01L1N-...						31306979	31306980
		R0,4 **	WP-TEC2-04F01L1U-...						31306981	31306982

** Wskazówka: nakroju EK i R0,4 używać tylko do obróbki otworów nieprzelotowych i obróbki powierzchni czołowych, w zależności od wymagań stawianych przez dany element

Płytki skrawające do narzędzi do obróbki zewnętrznej

Materiał skrawający	Węglik spiekany									
MZG*	P				M	K	N			
	1.1 - 1.2	2 - 3 5	4 6	1 - 3	1.1	2 - 3	1.1 - 1.2	2.3	2.1 - 2.2	
Rodzaj materiału skrawającego	HP115	HP425	HP016	HP016	HC418	HP426	HP612	HU615		

Geometria kształtu wióra	Wielkość	Nacięcie	Specyfikacja	Nr materiałowy							
neutralny	92	AS	WP-AS92L0-...								
		EK	WP-EK152L0-...								
		DZ	WP-DZ92L0-...				31301508				

dodatni	92	AS	WP-AS92L6-...	30914125	30914127	31056555	31056555				30914124
		EK	WP-EK152L6-...	30914554	31302302	31247603	31247603				30914553
		DZ	WP-DZ92L6-...	31306923	31306925	31306926	31306926		31306927		30914421

wysoki dodatni	92	AS	WP-AS92L2-...							31175426	30914120
		EK	WP-EK152L2-...							31301535	30914549
		DZ	WP-DZ92L2-...								

Ostrze z nakrojem AS



Ostrze z nakrojem EK



Ostrze z nakrojem DZ

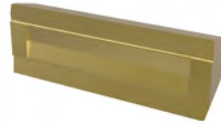

Węglik spiekany		
S		H
1 - 2		1.1
HU615		HP016

Cermet	
P	
1 - 3 5	
CP122	

PCD	
N	
1 - 2	
PU620	

PcBN		
K		H
1.1		1.1 - 1.2
FU485		FU801

Nr materiałowy		

Nr materiałowy	

Nr materiałowy	

Nr materiałowy		

30309015	
31301541	
31306928	

30914763**	
30914788**	

30914120		
30914549		

Osprzęt do narzędzi do obróbki zewnętrznej



Wielkość ostrza TEC	Kasety nożowe do narzędzia do obróbki zewnętrznej		Dociski do narzędzia do obróbki zewnętrznej	
	Specyfikacja	Nr materiałowy	Specyfikacja	Nr materiałowy
2	BC-EAS-L-42-B	30562954	CP-EAS-L-N2-B	30565468
2	BC-EAS-L-42-D	30558608	CP-EAS-L-N2-D	30560195
2	BC-EAS-L-42-F	30562956	CP-EAS-L-N2-F	30565469
2	BC-EAS-L-42-H	30562958	CP-EAS-L-N2-H	30565470
2	BC-EAS-L-42-K	30562959	CP-EAS-L-N2-K	30565472
2	BC-EAS-L-42-M	30562960	CP-EAS-L-N2-M	30565474
2	BC-EAS-L-42-P	30562963	CP-EAS-L-N2-P	30565475
2	BC-EAS-L-42-R	30562964	CP-EAS-L-N2-R	30565478
3	BC-EAS-L-43-B	30562965	CP-EAS-L-N3-B	30565479
3	BC-EAS-L-43-D	30562967	CP-EAS-L-N3-D	30565481
3	BC-EAS-L-43-F	30562968	CP-EAS-L-N3-F	30565483
3	BC-EAS-L-43-H	30562969	CP-EAS-L-N3-H	30565490
3	BC-EAS-L-43-K	30562970	CP-EAS-L-N3-K	30565491
3	BC-EAS-L-43-M	30562971	CP-EAS-L-N3-M	30565492
3	BC-EAS-L-43-P	30562972	CP-EAS-L-N3-P	30565494
3	BC-EAS-L-43-R	30562974	CP-EAS-L-N3-R	30565495



Zalecane parametry skrawania dla narzędzi do obróbki zewnętrznej z płytkami skrawającymi TEC

Posuw i prędkość skrawania

TEC2-AS-L-HP115

MZG*	Materiał obrabiany	Wytrzymałość/twardość [N/mm ²] [HRC]	Prędkość cięcia v_c (m/min)	Posuw f_z (mm/z)
			Chłodzenie wewnętrzne	
P P1	P1.1	Stale konstrukcyjne, użytkowe i uszlachetnione, stale niestopowe	80	0,150
	P1.2	Stale konstrukcyjne, użytkowe i uszlachetnione, stale niestopowe	70	0,150

TEC2-EK-L-HP115

MZG*	Materiał obrabiany	Wytrzymałość/twardość [N/mm ²] [HRC]	Prędkość cięcia v_c (m/min)	Posuw f_z (mm/z)
			Chłodzenie wewnętrzne	
P P1	P1.1	Stale konstrukcyjne, użytkowe i uszlachetnione, stale niestopowe	80	0,150
	P1.2	Stale konstrukcyjne, użytkowe i uszlachetnione, stale niestopowe	70	0,150

TEC2-DZ-L-HP115

MZG*	Materiał obrabiany	Wytrzymałość/twardość [N/mm ²] [HRC]	Prędkość cięcia v_c (m/min)	Posuw f_z (mm/z)
			Chłodzenie wewnętrzne	
P P1	P1.1	Stale konstrukcyjne, użytkowe i uszlachetnione, stale niestopowe	80	0,150
	P1.2	Stale konstrukcyjne, użytkowe i uszlachetnione, stale niestopowe	70	0,150

TEC2-04-L-HP115

MZG*	Materiał obrabiany	Wytrzymałość/twardość [N/mm ²] [HRC]	Prędkość cięcia v_c (m/min)	Posuw f_z (mm/z)
			Chłodzenie wewnętrzne	
P P1	P1.1	Stale konstrukcyjne, użytkowe i uszlachetnione, stale niestopowe	80	0,150
	P1.2	Stale konstrukcyjne, użytkowe i uszlachetnione, stale niestopowe	70	0,150

TEC2-AS-L-HP425

MZG*	Materiał obrabiany	Wytrzymałość/twardość [N/mm ²] [HRC]	Prędkość cięcia v_c (m/min)	Posuw f_z (mm/z)
			Chłodzenie wewnętrzne	
P	P2.1	Stale azotowane, użytkowe i uszlachetnione, stale stopowe	100	0,150
	P2.2	Stale azotowane, użytkowe i uszlachetnione, stale stopowe	80	0,150
	P3.1	Stale narzędziowe, łożyskowe, sprężynowe i stale szybkołtające**	100	0,150
	P3.2	Stale narzędziowe, łożyskowe, sprężynowe i stale szybkołtające**	80	0,150
	P5.1	Staliwo	80	0,150

* Grupa materiałowa wg MAPAL

** Jeśli składniki stopu Cr, Mo, Ni, V, W wynoszą łącznie > 8%, należy wybrać następną w kolejności grupę materiałową MAPAL.

TEC2-EK-L-HP425

MZG*	Materiał obrabiany	Wytrzymałość/twardość [N/mm ²] [HRC]	Prędkość cięcia v_c (m/min)	Posuw f_z (mm/z)	
			Chłodzenie wewnętrzne		
P	P2.1	Stale azotowane, użytkowe i uszlachetnione, stale stopowe	< 900	100	0,150
	P2.2	Stale azotowane, użytkowe i uszlachetnione, stale stopowe	< 1400	80	0,150
	P3.1	Stale narzędziowe, łożyskowe, sprężynowe i stale szybkoobrotowe**	< 900	100	0,150
	P3.2	Stale narzędziowe, łożyskowe, sprężynowe i stale szybkoobrotowe**	< 1500	80	0,150
	P5.1	Staliwo		80	0,150

TEC2-DZ-L-HP425

MZG*	Materiał obrabiany	Wytrzymałość/twardość [N/mm ²] [HRC]	Prędkość cięcia v_c (m/min)	Posuw f_z (mm/z)	
			Chłodzenie wewnętrzne		
P	P2.1	Stale azotowane, użytkowe i uszlachetnione, stale stopowe	< 900	100	0,150
	P2.2	Stale azotowane, użytkowe i uszlachetnione, stale stopowe	< 1400	80	0,150
	P3.1	Stale narzędziowe, łożyskowe, sprężynowe i stale szybkoobrotowe**	< 900	100	0,150
	P3.2	Stale narzędziowe, łożyskowe, sprężynowe i stale szybkoobrotowe**	< 1500	80	0,150
	P5.1	Staliwo		80	0,150

TEC2-04-L-HP425

MZG*	Materiał obrabiany	Wytrzymałość/twardość [N/mm ²] [HRC]	Prędkość cięcia v_c (m/min)	Posuw f_z (mm/z)	
			Chłodzenie wewnętrzne		
P	P2.1	Stale azotowane, użytkowe i uszlachetnione, stale stopowe	< 900	100	0,150
	P2.2	Stale azotowane, użytkowe i uszlachetnione, stale stopowe	< 1400	80	0,150
	P3.1	Stale narzędziowe, łożyskowe, sprężynowe i stale szybkoobrotowe**	< 900	100	0,150
	P3.2	Stale narzędziowe, łożyskowe, sprężynowe i stale szybkoobrotowe**	< 1500	80	0,150
	P5.1	Staliwo		80	0,150

TEC2-AS-L-HP016

MZG*	Materiał obrabiany	Wytrzymałość/twardość [N/mm ²] [HRC]	Prędkość cięcia v_c (m/min)	Posuw f_z (mm/z)
			Chłodzenie wewnętrzne	
P	P4.1	Stale nierdzewne, ferrytyczne i martenzytyczne	50	0,120
	P6.1	Staliwo nierdzewne, ferrytyczne i martenzytyczne	40	0,120
M	M1.1	Stale nierdzewne, austenityczne	50	0,120
	M1.2	Stale nierdzewne, ferrytyczne/austenityczne (Duplex)	30	0,120
	M2.1	Staliwo nierdzewne, austenityczne	50	0,120
M3	M3.1	Staliwo nierdzewne, ferrytyczne/austenityczne (Duplex)	30	0,120

Podane parametry skrawania to wartości orientacyjne.

Optymalne wartości dla danego przypadku obróbki należy ustalić w ramach próby lub podczas obróbki.

Zalecane parametry skrawania dla narzędzi do obróbki zewnętrznej z płytkami skrawającymi TEC

Posuw i prędkość skrawania

TEC2-EK-L-HP016

MZG*	Materiał obrabiany	Wytrzymałość/twardość [N/mm ²] [HRC]	Prędkość cięcia v_c (m/min)	Posuw f_z (mm/z)
			Chłodzenie wewnętrzne	
P4	P4.1	Stale nierdzewne, ferrytyczne i martenzytyczne	50	0,120
P6	P6.1	Staliwo nierdzewne, ferrytyczne i martenzytyczne	40	0,120
M	M1.1	Stale nierdzewne, austenityczne	< 700	0,120
	M1.2	Stale nierdzewne, ferrytyczne/austenityczne (Duplex)	< 1000	0,120
	M2.1	Staliwo nierdzewne, austenityczne	< 700	0,120
	M3.1	Staliwo nierdzewne, ferrytyczne/austenityczne (Duplex)	< 1000	0,120

TEC2-DZ-L-HP016

MZG*	Materiał obrabiany	Wytrzymałość/twardość [N/mm ²] [HRC]	Prędkość cięcia v_c (m/min)	Posuw f_z (mm/z)
			Chłodzenie wewnętrzne	
P4	P4.1	Stale nierdzewne, ferrytyczne i martenzytyczne	50	0,120
P6	P6.1	Staliwo nierdzewne, ferrytyczne i martenzytyczne	40	0,120
M	M1.1	Stale nierdzewne, austenityczne	< 700	0,120
	M1.2	Stale nierdzewne, ferrytyczne/austenityczne (Duplex)	< 1000	0,120
	M2.1	Staliwo nierdzewne, austenityczne	< 700	0,120
	M3.1	Staliwo nierdzewne, ferrytyczne/austenityczne (Duplex)	< 1000	0,120

TEC2-04-L-HP016

MZG*	Materiał obrabiany	Wytrzymałość/twardość [N/mm ²] [HRC]	Prędkość cięcia v_c (m/min)	Posuw f_z (mm/z)
			Chłodzenie wewnętrzne	
P4	P4.1	Stale nierdzewne, ferrytyczne i martenzytyczne	50	0,120
P6	P6.1	Staliwo nierdzewne, ferrytyczne i martenzytyczne	40	0,120
M	M1.1	Stale nierdzewne, austenityczne	< 700	0,120
	M1.2	Stale nierdzewne, ferrytyczne/austenityczne (Duplex)	< 1000	0,120
	M2.1	Staliwo nierdzewne, austenityczne	< 700	0,120
	M3.1	Staliwo nierdzewne, ferrytyczne/austenityczne (Duplex)	< 1000	0,120

TEC2-DZ-L-HC418

MZG*	Materiał obrabiany	Wytrzymałość/twardość [N/mm ²] [HRC]	Prędkość cięcia v_c (m/min)	Posuw f_z (mm/z)		
			Chłodzenie wewnętrzne			
K	K1	K1.1	Żeliwo z grafitem płatkowym (żeliwo szare), GJL	< 300	100	0,150

TEC2-04-L-HC418

MZG*	Materiał obrabiany	Wytrzymałość/twardość [N/mm ²] [HRC]	Prędkość cięcia v_c (m/min)	Posuw f_z (mm/z)
			Chłodzenie wewnętrzne	
K K1	K1.1 Żeliwo z grafitem płatkowym (żeliwo szare), GJL	< 300	100	0,150

TEC2-DZ-L-HP426

MZG*	Materiał obrabiany	Wytrzymałość/twardość [N/mm ²] [HRC]	Prędkość cięcia v_c (m/min)	Posuw f_z (mm/z)
			Chłodzenie wewnętrzne	
K2	K2.1 Żeliwo sferoidalne, GJS	< 500	100	0,150
	K2.2 Żeliwo sferoidalne, GJS	≤ 800	90	0,150
	K2.3 Żeliwo sferoidalne, GJS	> 800	80	0,150
K3	K3.1 Żeliwo wermikularne, GJV, (żeliwo ciągliwe), GJL	< 500	70	0,150
	K3.2 Żeliwo wermikularne, GJV, (żeliwo ciągliwe), GJL	> 500	70	0,150

TEC2-04-L-HP426

MZG*	Materiał obrabiany	Wytrzymałość/twardość [N/mm ²] [HRC]	Prędkość cięcia v_c (m/min)	Posuw f_z (mm/z)
			Chłodzenie wewnętrzne	
K2	K2.1 Żeliwo sferoidalne, GJS	< 500	100	0,150
	K2.2 Żeliwo sferoidalne, GJS	≤ 800	90	0,150
	K2.3 Żeliwo sferoidalne, GJS	> 800	80	0,150
K3	K3.1 Żeliwo wermikularne, GJV, (żeliwo ciągliwe), GJL	< 500	70	0,150
	K3.2 Żeliwo wermikularne, GJV, (żeliwo ciągliwe), GJL	> 500	70	0,150

TEC2-AS-L-HP612

MZG*	Materiał obrabiany	Wytrzymałość/twardość [N/mm ²] [HRC]	Prędkość cięcia v_c (m/min)	Posuw f_z (mm/z)
			Chłodzenie wewnętrzne	
N N1	N1.1 Aluminium, niestopowe i stopowe < 3 % Si		160	0,150
	N1.2 Aluminium, stopowe ≤ 7 % Si		160	0,150

TEC2-EK-L-HP612

MZG*	Materiał obrabiany	Wytrzymałość/twardość [N/mm ²] [HRC]	Prędkość cięcia v_c (m/min)	Posuw f_z (mm/z)
			Chłodzenie wewnętrzne	
N N1	N1.1 Aluminium, niestopowe i stopowe < 3 % Si		160	0,150
	N1.2 Aluminium, stopowe ≤ 7 % Si		160	0,150

Podane parametry skrawania to wartości orientacyjne.

Optymalne wartości dla danego przypadku obróbki należy ustalić w ramach próby lub podczas obróbki.

Zalecane parametry skrawania dla narzędzi do obróbki zewnętrznej z płytkami skrawającymi TEC

Posuw i prędkość skrawania

TEC2-DZ-L-HP612

MZG*	Materiał obrabiany	Wytrzymałość/twardość [N/mm ²] [HRC]	Prędkość cięcia v _c (m/min)	Posuw f _z (mm/z)
			Chłodzenie wewnętrzne	
N N1	N1.1	Aluminium, niestopowe i stopowe < 3 % Si	160	0,150
	N1.2	Aluminium, stopowe ≤ 7 % Si	160	0,150

TEC2-04-L-HP612

MZG*	Materiał obrabiany	Wytrzymałość/twardość [N/mm ²] [HRC]	Prędkość cięcia v _c (m/min)	Posuw f _z (mm/z)
			Chłodzenie wewnętrzne	
N N1	N1.1	Aluminium, niestopowe i stopowe < 3 % Si	160	0,150
	N1.2	Aluminium, stopowe ≤ 7 % Si	160	0,150

TEC2-AS-L-HU615

MZG*	Materiał obrabiany	Wytrzymałość/twardość [N/mm ²] [HRC]	Prędkość cięcia v _c (m/min)	Posuw f _z (mm/z)
			Chłodzenie wewnętrzne	
N N2	N2.1	Miedź, niestopowa i niskostopowa	100	0,150
	N2.2	Miedź, stopowa	100	0,150
	N2.3	Mosiądz, brąz, spiż	100	0,150
S S1	S1.1	Tytan, stopy tytanu	30	0,120
	S2.1	Tytan, stopy tytanu	20	0,120
	S2.2	Tytan, stopy tytanu	20	0,100

TEC2-EK-L-HU615

MZG*	Materiał obrabiany	Wytrzymałość/twardość [N/mm ²] [HRC]	Prędkość cięcia v _c (m/min)	Posuw f _z (mm/z)
			Chłodzenie wewnętrzne	
N N2	N2.1	Miedź, niestopowa i niskostopowa	100	0,150
	N2.2	Miedź, stopowa	100	0,150
	N2.3	Mosiądz, brąz, spiż	100	0,150
S S1	S1.1	Tytan, stopy tytanu	30	0,120
	S2.1	Tytan, stopy tytanu	20	0,120
	S2.2	Tytan, stopy tytanu	20	0,100

* Grupa materiałowa wg MAPAL

** Jeśli składniki stopu Cr, Mo, Ni, V, W wynoszą łącznie > 8%, należy wybrać następną w kolejności grupę materiałową MAPAL.

TEC2-DZ-L-HU615

MZG*		Materiał obrabiany	Wytrzymałość/twardość [N/mm ²] [HRC]	Prędkość cięcia v_c (m/min)	Posuw f_z (mm/z)	
				Chłodzenie wewnętrzne		
N	N2	N2.1	Miedź, niestopowa i niskostopowa	< 300	100	0,150
		N2.2	Miedź, stopowa	> 300	100	0,150
		N2.3	Mosiądz, brąz, spiż	< 1200	100	0,150
S	S1 S2	S1.1	Tytan, stopy tytanu	< 400	30	0,120
		S2.1	Tytan, stopy tytanu	< 1200	20	0,120
		S2.2	Tytan, stopy tytanu	> 1200	20	0,100

TEC2-04-L-HU615

MZG*		Materiał obrabiany	Wytrzymałość/twardość [N/mm ²] [HRC]	Prędkość cięcia v_c (m/min)	Posuw f_z (mm/z)	
				Chłodzenie wewnętrzne		
N	N2	N2.1	Miedź, niestopowa i niskostopowa	< 300	100	0,150
		N2.2	Miedź, stopowa	> 300	100	0,150
		N2.3	Mosiądz, brąz, spiż	< 1200	100	0,150
S	S1 S2	S1.1	Tytan, stopy tytanu	< 400	30	0,120
		S2.1	Tytan, stopy tytanu	< 1200	20	0,120
		S2.2	Tytan, stopy tytanu	> 1200	20	0,100

TEC2-AS-L-CP122

MZG*		Materiał obrabiany	Wytrzymałość/twardość [N/mm ²] [HRC]	Prędkość cięcia v_c (m/min)	Posuw f_z (mm/z)	
				Chłodzenie wewnętrzne		
P	P1	P1.1	Stale konstrukcyjne, użytkowe i uszlachetnione, stale niestopowe	< 700	180	0,150
		P1.2	Stale konstrukcyjne, użytkowe i uszlachetnione, stale niestopowe	< 1200	160	0,120
	P2	P2.1	Stale azotowane, użytkowe i uszlachetnione, stale stopowe	< 900	160	0,150
		P2.2	Stale azotowane, użytkowe i uszlachetnione, stale stopowe	< 1400	140	0,120
	P3	P3.1	Stale narzędziowe, łożyskowe, sprężynowe i stale szybkoobrotowe**	< 800	160	0,150
		P3.2	Stale narzędziowe, łożyskowe, sprężynowe i stale szybkoobrotowe**	< 1000	160	0,150
		P3.3	Stale narzędziowe, łożyskowe, sprężynowe i stale szybkoobrotowe**	< 1500	140	0,120
	P5	P5.1	Staliwo		140	0,120

Podane parametry skrawania to wartości orientacyjne.

Optymalne wartości dla danego przypadku obróbki należy ustalić w ramach próby lub podczas obróbki.

Zalecane parametry skrawania dla narzędzi do obróbki zewnętrznej z płytkami skrawającymi TEC

Posuw i prędkość skrawania

TEC2-EK-L-CP122

MZG*		Materiał obrabiany	Wytrzymałość/twardość [N/mm ²] [HRC]	Prędkość cięcia v_c (m/min)		Posuw f_z (mm/z)
				Chłodzenie wewnętrzne		
P	P1	P1.1	Stale konstrukcyjne, użytkowe i uszlachetnione, stale niestopowe	< 700	180	0,150
		P1.2	Stale konstrukcyjne, użytkowe i uszlachetnione, stale niestopowe	< 1200	160	0,120
	P2	P2.1	Stale azotowane, użytkowe i uszlachetnione, stale stopowe	< 900	160	0,150
		P2.2	Stale azotowane, użytkowe i uszlachetnione, stale stopowe	< 1400	140	0,120
	P3	P3.1	Stale narzędziowe, łożyskowe, sprężynowe i stale szybkoobrotowe**	< 800	160	0,150
		P3.2	Stale narzędziowe, łożyskowe, sprężynowe i stale szybkoobrotowe**	< 1000	160	0,150
		P3.3	Stale narzędziowe, łożyskowe, sprężynowe i stale szybkoobrotowe**	< 1500	140	0,120
	P5	P5.1	Staliwo		140	0,120

TEC2-DZ-L-CP122

MZG*		Materiał obrabiany	Wytrzymałość/twardość [N/mm ²] [HRC]	Prędkość cięcia v_c (m/min)		Posuw f_z (mm/z)
				Chłodzenie wewnętrzne		
P	P1	P1.1	Stale konstrukcyjne, użytkowe i uszlachetnione, stale niestopowe	< 700	180	0,150
		P1.2	Stale konstrukcyjne, użytkowe i uszlachetnione, stale niestopowe	< 1200	160	0,120
	P2	P2.1	Stale azotowane, użytkowe i uszlachetnione, stale stopowe	< 900	160	0,150
		P2.2	Stale azotowane, użytkowe i uszlachetnione, stale stopowe	< 1400	140	0,120
	P3	P3.1	Stale narzędziowe, łożyskowe, sprężynowe i stale szybkoobrotowe**	< 800	160	0,150
		P3.2	Stale narzędziowe, łożyskowe, sprężynowe i stale szybkoobrotowe**	< 1000	160	0,150
		P3.3	Stale narzędziowe, łożyskowe, sprężynowe i stale szybkoobrotowe**	< 1500	140	0,120
	P5	P5.1	Staliwo		140	0,120

TEC2-04-L-CP122

MZG*		Materiał obrabiany	Wytrzymałość/twardość [N/mm ²] [HRC]	Prędkość cięcia v_c (m/min)		Posuw f_z (mm/z)
				Chłodzenie wewnętrzne		
P	P1	P1.1	Stale konstrukcyjne, użytkowe i uszlachetnione, stale niestopowe	< 700	180	0,150
		P1.2	Stale konstrukcyjne, użytkowe i uszlachetnione, stale niestopowe	< 1200	160	0,120
	P2	P2.1	Stale azotowane, użytkowe i uszlachetnione, stale stopowe	< 900	160	0,150
		P2.2	Stale azotowane, użytkowe i uszlachetnione, stale stopowe	< 1400	140	0,120
	P3	P3.1	Stale narzędziowe, łożyskowe, sprężynowe i stale szybkoobrotowe**	< 800	160	0,150
		P3.2	Stale narzędziowe, łożyskowe, sprężynowe i stale szybkoobrotowe**	< 1000	160	0,150
		P3.3	Stale narzędziowe, łożyskowe, sprężynowe i stale szybkoobrotowe**	< 1500	140	0,120
	P5	P5.1	Staliwo		140	0,120

* Grupa materiałowa wg MAPAL

** Jeśli składniki stopu Cr, Mo, Ni, V, W wynoszą łącznie > 8%, należy wybrać następną w kolejności grupę materiałową MAPAL.

TEC2-AS-L-PU620

MZG*	Materiał obrabiany	Wytrzymałość/twardość [N/mm ²] [HRC]	Prędkość cięcia v_c (m/min)	Posuw f_z (mm/z)
			Chłodzenie wewnętrzne	
N	N1	N1.1 Aluminium, niestopowe i stopowe < 3 % Si	230	0,150
		N1.2 Aluminium, stopowe ≤ 7 % Si	230	0,150
		N1.3 Aluminium, stopowe > 7-12 % Si	230	0,150
		N1.4 Aluminium, stopowe > 12 % Si	230	0,150
N	N2	N2.1 Miedź, niestopowa i niskostopowa	180	0,150
		N2.2 Miedź, stopowa	180	0,150
		N2.3 Mosiądz, brąz, spiż	180	0,150

TEC2-EK-L-PU620

MZG*	Materiał obrabiany	Wytrzymałość/twardość [N/mm ²] [HRC]	Prędkość cięcia v_c (m/min)	Posuw f_z (mm/z)
			Chłodzenie wewnętrzne	
N	N1	N1.1 Aluminium, niestopowe i stopowe < 3 % Si	230	0,150
		N1.2 Aluminium, stopowe ≤ 7 % Si	230	0,150
		N1.3 Aluminium, stopowe > 7-12 % Si	230	0,150
		N1.4 Aluminium, stopowe > 12 % Si	230	0,150
N	N2	N2.1 Miedź, niestopowa i niskostopowa	180	0,150
		N2.2 Miedź, stopowa	180	0,150
		N2.3 Mosiądz, brąz, spiż	180	0,150

TEC2-DZ-L-PU620

MZG*	Materiał obrabiany	Wytrzymałość/twardość [N/mm ²] [HRC]	Prędkość cięcia v_c (m/min)	Posuw f_z (mm/z)
			Chłodzenie wewnętrzne	
N	N1	N1.1 Aluminium, niestopowe i stopowe < 3 % Si	230	0,150
		N1.2 Aluminium, stopowe ≤ 7 % Si	230	0,150
		N1.3 Aluminium, stopowe > 7-12 % Si	230	0,150
		N1.4 Aluminium, stopowe > 12 % Si	230	0,150
N	N2	N2.1 Miedź, niestopowa i niskostopowa	180	0,150
		N2.2 Miedź, stopowa	180	0,150
		N2.3 Mosiądz, brąz, spiż	180	0,150

TEC2-04-L-PU620

MZG*	Materiał obrabiany	Wytrzymałość/twardość [N/mm ²] [HRC]	Prędkość cięcia v_c (m/min)	Posuw f_z (mm/z)
			Chłodzenie wewnętrzne	
N	N1	N1.1 Aluminium, niestopowe i stopowe < 3 % Si	230	0,150
		N1.2 Aluminium, stopowe ≤ 7 % Si	230	0,150
		N1.3 Aluminium, stopowe > 7-12 % Si	230	0,150
		N1.4 Aluminium, stopowe > 12 % Si	230	0,150
N	N2	N2.1 Miedź, niestopowa i niskostopowa	180	0,150
		N2.2 Miedź, stopowa	180	0,150
		N2.3 Mosiądz, brąz, spiż	180	0,150

Podane parametry skrawania to wartości orientacyjne.

Optymalne wartości dla danego przypadku obróbki należy ustalić w ramach próby lub podczas obróbki.

Zalecane parametry skrawania dla narzędzi do obróbki zewnętrznej z płytkami skrawającymi

Posuw i prędkość skrawania

AS-L-HP115

MZG*	Materiał obrabiany	Wytrzymałość/twardość [N/mm ²] [HRC]	Prędkość cięcia v _c (m/min)	Posuw f _z (mm/z)
			Chłodzenie wewnętrzne	
P P1	P1.1	Stale konstrukcyjne, użytkowe i uszlachetnione, stale niestopowe	80	0,150
	P1.2	Stale konstrukcyjne, użytkowe i uszlachetnione, stale niestopowe	70	0,150

EK-L-HP115

MZG*	Materiał obrabiany	Wytrzymałość/twardość [N/mm ²] [HRC]	Prędkość cięcia v _c (m/min)	Posuw f _z (mm/z)
			Chłodzenie wewnętrzne	
P P1	P1.1	Stale konstrukcyjne, użytkowe i uszlachetnione, stale niestopowe	80	0,150
	P1.2	Stale konstrukcyjne, użytkowe i uszlachetnione, stale niestopowe	70	0,150

DZ-L-HP115

MZG*	Materiał obrabiany	Wytrzymałość/twardość [N/mm ²] [HRC]	Prędkość cięcia v _c (m/min)	Posuw f _z (mm/z)
			Chłodzenie wewnętrzne	
P P1	P1.1	Stale konstrukcyjne, użytkowe i uszlachetnione, stale niestopowe	80	0,150
	P1.2	Stale konstrukcyjne, użytkowe i uszlachetnione, stale niestopowe	70	0,150

AS-L-HP425

MZG*	Materiał obrabiany	Wytrzymałość/twardość [N/mm ²] [HRC]	Prędkość cięcia v _c (m/min)	Posuw f _z (mm/z)	
			Chłodzenie wewnętrzne		
P	P2	P2.1	Stale azotowane, użytkowe i uszlachetnione, stale stopowe	100	0,150
		P2.2	Stale azotowane, użytkowe i uszlachetnione, stale stopowe	80	0,150
	P3	P3.1	Stale narzędziowe, łożyskowe, sprężynowe i stale szybkotnące**	100	0,150
		P3.2	Stale narzędziowe, łożyskowe, sprężynowe i stale szybkotnące**	80	0,150
	P5	P5.1	Staliwo	80	0,150

* Grupa materiałowa wg MAPAL

** Jeśli składniki stopu Cr, Mo, Ni, V, W wynoszą łącznie > 8%, należy wybrać następną w kolejności grupę materiałową MAPAL.

EK-L-HP425

MZG*	Materiał obrabiany	Wytrzymałość/twardość [N/mm ²] [HRC]	Prędkość cięcia v_c (m/min)	Posuw f_z (mm/z)
			Chłodzenie wewnętrzne	
P	P2.1	Stale azotowane, użytkowe i uszlachetnione, stale stopowe	100	0,150
	P2.2	Stale azotowane, użytkowe i uszlachetnione, stale stopowe	80	0,150
	P3.1	Stale narzędziowe, łożyskowe, sprężynowe i stale szybko tnące**	100	0,150
	P3.2	Stale narzędziowe, łożyskowe, sprężynowe i stale szybko tnące**	80	0,150
	P5.1	Staliwo	80	0,150

DZ-L-HP425

MZG*	Materiał obrabiany	Wytrzymałość/twardość [N/mm ²] [HRC]	Prędkość cięcia v_c (m/min)	Posuw f_z (mm/z)
			Chłodzenie wewnętrzne	
P	P2.1	Stale azotowane, użytkowe i uszlachetnione, stale stopowe	100	0,150
	P2.2	Stale azotowane, użytkowe i uszlachetnione, stale stopowe	80	0,150
	P3.1	Stale narzędziowe, łożyskowe, sprężynowe i stale szybko tnące**	100	0,150
	P3.2	Stale narzędziowe, łożyskowe, sprężynowe i stale szybko tnące**	80	0,150
	P5.1	Staliwo	80	0,150

AS-L-HP016

MZG*	Materiał obrabiany	Wytrzymałość/twardość [N/mm ²] [HRC]	Prędkość cięcia v_c (m/min)	Posuw f_z (mm/z)
			Chłodzenie wewnętrzne	
P	P4.1	Stale nierdzewne, ferrytyczne i martenzytyczne	50	0,120
	P6.1	Staliwo nierdzewne, ferrytyczne i martenzytyczne	40	0,120
M	M1.1	Stale nierdzewne, austenityczne	50	0,120
	M1.2	Stale nierdzewne, ferrytyczne/austenityczne (Duplex)	30	0,120
	M2.1	Staliwo nierdzewne, austenityczne	50	0,120
M3.1	Staliwo nierdzewne, ferrytyczne/austenityczne (Duplex)	30	0,120	

EK-L-HP016

MZG*	Materiał obrabiany	Wytrzymałość/twardość [N/mm ²] [HRC]	Prędkość cięcia v_c (m/min)	Posuw f_z (mm/z)
			Chłodzenie wewnętrzne	
P	P4.1	Stale nierdzewne, ferrytyczne i martenzytyczne	50	0,120
	P6.1	Staliwo nierdzewne, ferrytyczne i martenzytyczne	40	0,120
M	M1.1	Stale nierdzewne, austenityczne	50	0,120
	M1.2	Stale nierdzewne, ferrytyczne/austenityczne (Duplex)	30	0,120
	M2.1	Staliwo nierdzewne, austenityczne	50	0,120
M3.1	Staliwo nierdzewne, ferrytyczne/austenityczne (Duplex)	30	0,120	

Podane parametry skrawania to wartości orientacyjne.

Optymalne wartości dla danego przypadku obróbki należy ustalić w ramach próby lub podczas obróbki.

Zalecane parametry skrawania dla narzędzi do obróbki zewnętrznej z płytkami skrawającymi

Posuw i prędkość skrawania

DZ-L-HP016

MZG*	Materiał obrabiany	Wytrzymałość/twardość [N/mm ²] [HRC]	Prędkość cięcia v _c (m/min)	Posuw f _z (mm/z)	
			Chłodzenie wewnętrzne		
P4	P4.1	Stale nierdzewne, ferrytyczne i martenzytyczne	50	0,120	
	P6.1	Staliwo nierdzewne, ferrytyczne i martenzytyczne	40	0,120	
M	M1.1	Stale nierdzewne, austenityczne	< 700	50	0,120
		Stale nierdzewne, ferrytyczne/austenityczne (Duplex)	< 1000	30	0,120
	M2.1	Staliwo nierdzewne, austenityczne	< 700	50	0,120
	M3.1	Staliwo nierdzewne, ferrytyczne/austenityczne (Duplex)	< 1000	30	0,120

DZ-L-HC418

MZG*	Materiał obrabiany	Wytrzymałość/twardość [N/mm ²] [HRC]	Prędkość cięcia v _c (m/min)	Posuw f _z (mm/z)	
			Chłodzenie wewnętrzne		
K	K1.1	Żeliwo z grafitem płatkowym (żeliwo szare), GJL	< 300	100	0,150

DZ-L-HP426

MZG*	Materiał obrabiany	Wytrzymałość/twardość [N/mm ²] [HRC]	Prędkość cięcia v _c (m/min)	Posuw f _z (mm/z)	
			Chłodzenie wewnętrzne		
K2	K2.1	Żeliwo sferoidalne, GJS	< 500	100	0,150
	K2.2	Żeliwo sferoidalne, GJS	≤ 800	90	0,150
	K2.3	Żeliwo sferoidalne, GJS	> 800	80	0,150
K3	K3.1	Żeliwo wermikularne, GJV, (żeliwo ciągliwe), GJL	< 500	70	0,150
	K3.2	Żeliwo wermikularne, GJV, (żeliwo ciągliwe), GJL	> 500	70	0,150

AS-L-HP612

MZG*	Materiał obrabiany	Wytrzymałość/twardość [N/mm ²] [HRC]	Prędkość cięcia v _c (m/min)	Posuw f _z (mm/z)	
			Chłodzenie wewnętrzne		
N	N1	N1.1	Aluminium, niestopowe i stopowe < 3 % Si	160	0,150
		N1.2	Aluminium, stopowe ≤ 7 % Si	160	0,150

EK-L-HP612

MZG*	Materiał obrabiany	Wytrzymałość/twardość [N/mm ²] [HRC]	Prędkość cięcia v _c (m/min)	Posuw f _z (mm/z)	
			Chłodzenie wewnętrzne		
N	N1	N1.1	Aluminium, niestopowe i stopowe < 3 % Si	160	0,150
		N1.2	Aluminium, stopowe ≤ 7 % Si	160	0,150

* Grupa materiałowa wg MAPAL

AS-L-HU615

MZG*		Materiał obrabiany	Wytrzymałość/twardość [N/mm ²] [HRC]	Prędkość cięcia v_c (m/min)	Posuw f_z (mm/z)	
				Chłodzenie wewnętrzne		
N	N2	N2.1	Miedź, niestopowa i niskostopowa	< 300	100	0,150
		N2.2	Miedź, stopowa	> 300	100	0,150
		N2.3	Mosiądz, brąz, spiż	< 1200	100	0,150
S	S1	S1.1	Tytan, stopy tytanu	< 400	30	0,120
		S2.1	Tytan, stopy tytanu	< 1200	20	0,120
		S2.2	Tytan, stopy tytanu	> 1200	20	0,100

EK-L-HU615

MZG*		Materiał obrabiany	Wytrzymałość/twardość [N/mm ²] [HRC]	Prędkość cięcia v_c (m/min)	Posuw f_z (mm/z)	
				Chłodzenie wewnętrzne		
N	N2	N2.1	Miedź, niestopowa i niskostopowa	< 300	100	0,150
		N2.2	Miedź, stopowa	> 300	100	0,150
		N2.3	Mosiądz, brąz, spiż	< 1200	100	0,150
S	S1	S1.1	Tytan, stopy tytanu	< 400	30	0,120
		S2.1	Tytan, stopy tytanu	< 1200	20	0,120
		S2.2	Tytan, stopy tytanu	> 1200	20	0,100

DZ-L-HU615

MZG*		Materiał obrabiany	Wytrzymałość/twardość [N/mm ²] [HRC]	Prędkość cięcia v_c (m/min)	Posuw f_z (mm/z)	
				Chłodzenie wewnętrzne		
N	N2	N2.1	Miedź, niestopowa i niskostopowa	< 300	100	0,150
		N2.2	Miedź, stopowa	> 300	100	0,150
		N2.3	Mosiądz, brąz, spiż	< 1200	100	0,150

Podane parametry skrawania to wartości orientacyjne.

Optymalne wartości dla danego przypadku obróbki należy ustalić w ramach próby lub podczas obróbki.

Zalecane parametry skrawania dla narzędzi do obróbki zewnętrznej z płytkami skrawającymi

Posuw i prędkość skrawania

AS-L-CP122

MZG*	Materiał obrabiany	Wytrzymałość/twardość [N/mm ²] [HRC]	Prędkość cięcia v_c (m/min)	Posuw f_z (mm/z)
			Chłodzenie wewnętrzne	
P	P1.1	Stale konstrukcyjne, użytkowe i uszlachetnione, stale niestopowe	180	0,150
		Stale konstrukcyjne, użytkowe i uszlachetnione, stale niestopowe	160	0,120
	P2.1	Stale azotowane, użytkowe i uszlachetnione, stale stopowe	160	0,150
		Stale azotowane, użytkowe i uszlachetnione, stale stopowe	140	0,120
	P3.1	Stale narzędziowe, łożyskowe, sprężynowe i stale szybkoobrotowe**	160	0,150
		Stale narzędziowe, łożyskowe, sprężynowe i stale szybkoobrotowe**	160	0,150
		Stale narzędziowe, łożyskowe, sprężynowe i stale szybkoobrotowe**	140	0,120
	P5.1	Staliwo	140	0,120

EK-L-CP122

MZG*	Materiał obrabiany	Wytrzymałość/twardość [N/mm ²] [HRC]	Prędkość cięcia v_c (m/min)	Posuw f_z (mm/z)
			Chłodzenie wewnętrzne	
P	P1.1	Stale konstrukcyjne, użytkowe i uszlachetnione, stale niestopowe	180	0,150
		Stale konstrukcyjne, użytkowe i uszlachetnione, stale niestopowe	160	0,120
	P2.1	Stale azotowane, użytkowe i uszlachetnione, stale stopowe	160	0,150
		Stale azotowane, użytkowe i uszlachetnione, stale stopowe	140	0,120
	P3.1	Stale narzędziowe, łożyskowe, sprężynowe i stale szybkoobrotowe**	160	0,150
		Stale narzędziowe, łożyskowe, sprężynowe i stale szybkoobrotowe**	160	0,150
		Stale narzędziowe, łożyskowe, sprężynowe i stale szybkoobrotowe**	140	0,120
	P5.1	Staliwo	140	0,120

DZ-L-CP122

MZG*	Materiał obrabiany	Wytrzymałość/twardość [N/mm ²] [HRC]	Prędkość cięcia v_c (m/min)	Posuw f_z (mm/z)
			Chłodzenie wewnętrzne	
P	P1.1	Stale konstrukcyjne, użytkowe i uszlachetnione, stale niestopowe	180	0,150
		Stale konstrukcyjne, użytkowe i uszlachetnione, stale niestopowe	160	0,120
	P2.1	Stale azotowane, użytkowe i uszlachetnione, stale stopowe	160	0,150
		Stale azotowane, użytkowe i uszlachetnione, stale stopowe	140	0,120
	P3.1	Stale narzędziowe, łożyskowe, sprężynowe i stale szybkoobrotowe**	160	0,150
		Stale narzędziowe, łożyskowe, sprężynowe i stale szybkoobrotowe**	160	0,150
		Stale narzędziowe, łożyskowe, sprężynowe i stale szybkoobrotowe**	140	0,120
	P5.1	Staliwo	140	0,120

* Grupa materiałowa wg MAPAL

** Jeśli składniki stopu Cr, Mo, Ni, V, W wynoszą łącznie > 8%, należy wybrać następną w kolejności grupę materiałową MAPAL.

AS-L-PU620

MZG*	Materiał obrabiany	Wytrzymałość/twardość [N/mm ²] [HRC]	Prędkość cięcia v_c (m/min)	Posuw f_z (mm/z)	
			Chłodzenie wewnętrzne		
N	N1	N1.1 Aluminium, niestopowe i stopowe < 3 % Si	230	0,150	
		N1.2 Aluminium, stopowe ≤ 7 % Si	230	0,150	
		N1.3 Aluminium, stopowe > 7-12 % Si	230	0,150	
		N1.4 Aluminium, stopowe > 12 % Si	230	0,150	
	N2	N2.1 Miedź, niestopowa i niskostopowa	< 300	180	0,150
		N2.2 Miedź, stopowa	> 300	180	0,150
		N2.3 Mosiądz, brąz, spiż	< 1200	180	0,150

EK-L-PU620

MZG*	Materiał obrabiany	Wytrzymałość/twardość [N/mm ²] [HRC]	Prędkość cięcia v_c (m/min)	Posuw f_z (mm/z)	
			Chłodzenie wewnętrzne		
N	N1	N1.1 Aluminium, niestopowe i stopowe < 3 % Si	230	0,150	
		N1.2 Aluminium, stopowe ≤ 7 % Si	230	0,150	
		N1.3 Aluminium, stopowe > 7-12 % Si	230	0,150	
		N1.4 Aluminium, stopowe > 12 % Si	230	0,150	
	N2	N2.1 Miedź, niestopowa i niskostopowa	< 300	180	0,150
		N2.2 Miedź, stopowa	> 300	180	0,150
		N2.3 Mosiądz, brąz, spiż	< 1200	180	0,150

Podane parametry skrawania to wartości orientacyjne.

Optymalne wartości dla danego przypadku obróbki należy ustalić w ramach próby lub podczas obróbki.

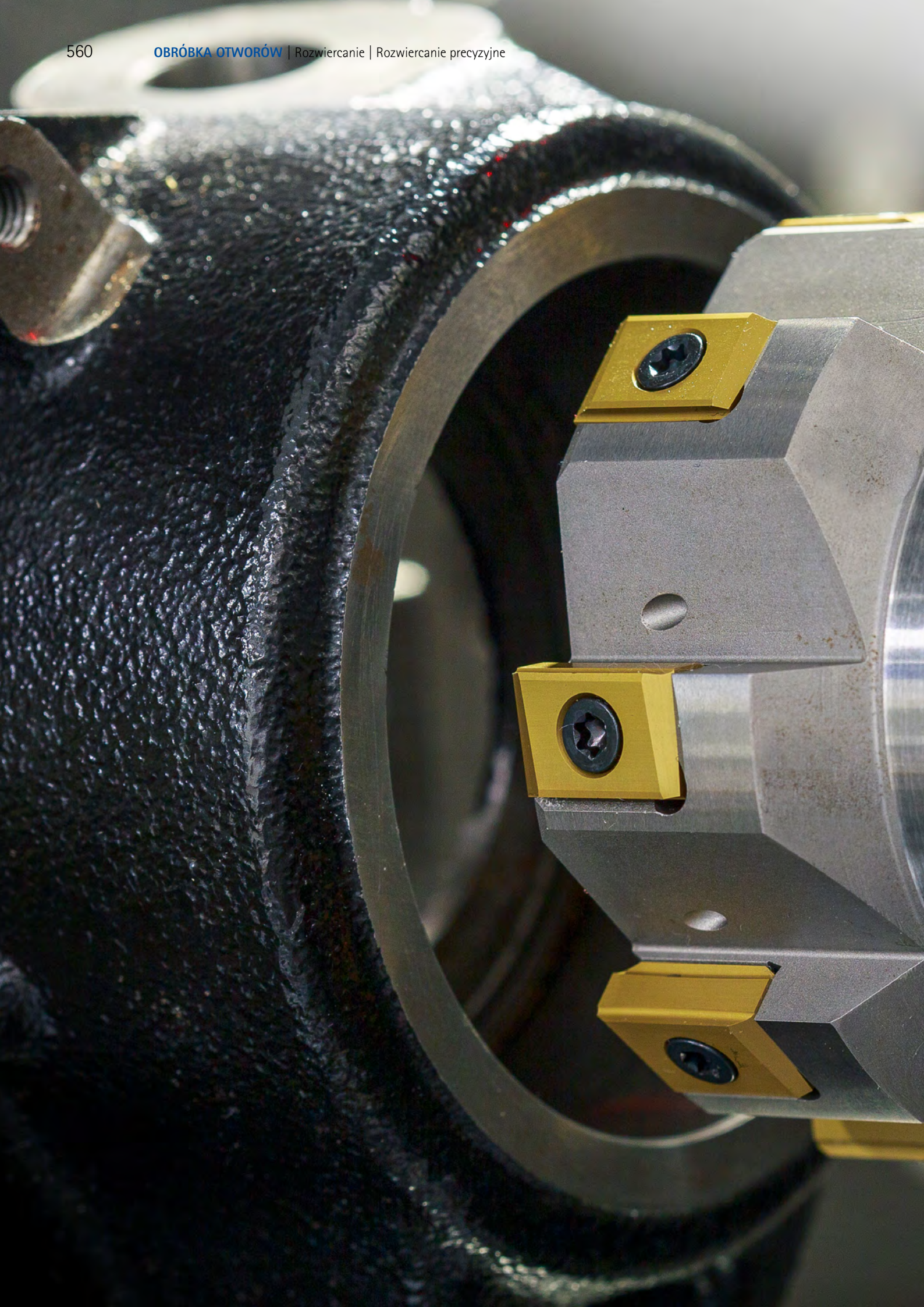

ROZWIĄZANIA DO OTWORÓW O DUŻYCH ŚREDNICACH | ROZ- WIĄZANIA SPECJALNE

Rozwiązania do otworów o dużych średnicach

Przegląd programu	562
HPR400 plus	564
HPR400	568

Rozwiązania specjalne

Narzędzia z listwami prowadzącymi	572
Narzędzia z systemem EasyAdjust	574
Stałe rozwiertaki wieloostrzowe	576



PRZEGLĄD PROGRAMU

Wieloostrzowe rozwiertaki wysoko wydajne do dużych zakresów średnicy

W odniesieniu do obróbki precyzyjnej otworów o dużych średnicach w ramach określonej tolerancji, użytkownicy często stają przed pytaniem: rozwiercać czy wytaczać? Z jednej strony wieloostrzowe narzędzia do rozwiercania znacznie przyspieszają pracę i są mniej wrażliwe w przypadku obróbki przerywanej. Z drugiej strony przygotowanie rozwiertaków o stałych ostrzach wymaga dużych nakładów.

MAPAL oferuje dwa systemy HPR optymalizujące proces regeneracji:

HPR400 plus

Głównym celem opracowania rozwiertaków HPR400 plus było zwiększenie efektywności ekonomicznej przez umożliwienie skutecznej regeneracji. Narzędzia wieloostrzowe wyróżniają się wysoką ekonomicznością dzięki możliwości szybkiego wprowadzenia parametrów skrawania i prostej wymiany ostrza na miejscu przez klienta dzięki bardzo dokładnemu przygotowaniu gniazd płytek. Pozwala to całkowicie wyeliminować koszty logistyczne związane z transportem narzędzia do producenta, a także utrzymać na niskim poziomie rotację narzędzi i koszty regeneracji. Płytki skrawające z czterema krawędziami skrawającymi gwarantują optymalne wykorzystanie materiału skrawającego.

HPR400

Łatwa wymiana ostrzy na miejscu

W celu zmniejszenia stanów magazynowych i rotacji narzędzi MAPAL oferuje system HPR400, w którym wymiana ostrzy może być przeprowadzona bezpośrednio na miejscu przez klienta. Korpusy narzędzi nie wymagają regeneracji, a użytkownik ponosi jedynie koszty przechowywania potrzebnych ostrzy.



HPR



HPR400 plus

Cztery krawędzie skrawające dla wysokiej ekonomiczności.

- Brak kosztów logistycznych związanych z wysyłką narzędzia do producenta w celu regeneracji
- Możliwość realizacji tolerancji IT7 od średnicy 65,000 mm

Zakres \varnothing : 63,000 - 319,999 mm



HPR400

Łatwa wymiana ostrzy na miejscu.

- Nieprawidłowy montaż ostrzy jest niemożliwy, ponieważ mogą być one montowane w dowolnej pozycji.

Zakres \varnothing : 63,000 - 319,999 mm



HPR400 plus

Brak konieczności regulacji i cztery krawędzie skrawające znacznie obniżające koszt jednostkowy części

Zwiększenie efektywności ekonomicznej przez umożliwienie skutecznej regeneracji było głównym celem opracowania rozwiertaków HPR400. Narzędzia wieloostrowe wyróżniają się wysoką ekonomicznością dzięki możliwości szybkiego wprowadzenia parametrów skrawania i prostej wymiany ostrza na miejscu przez klienta dzięki bardzo dokładnemu przygotowaniu gniazd płytek. Pozwala to całkowicie wyeliminować koszty logistyczne związane z transportem narzędzia do producenta, a także utrzymać na niskim poziomie rotację narzędzi i koszty regeneracji.

Aby jeszcze bardziej poprawić ekonomiczność obróbki dużych średnic, płytki skrawające nowo opracowanego systemu HPR400 plus nie są już jednokrawędziowe, lecz posiadają cztery krawędzie skrawające. Dzięki temu materiał skrawający jest optymalnie wykorzystywany. Czteroostrowe płytki skrawające są wykonane tak precyzyjnie, że bez problemu możliwe jest ich obracanie lub wymiana na miejscu przez personel klienta.

Pozwala to na dalsze zmniejszenie zapasu ostrzy i obniżenie kosztów regeneracji, a tym samym – kosztu jednostkowego części.

W SKRÓCIE

- Wymiana ostrzy na miejscu przez klienta
- Cztery krawędzie skrawające zamiast jednej
- Zakres średnicy od 63,000 do 319,999 mm
- Uniwersalne zastosowanie ze wszystkimi obrabianymi materiałami
- Optymalne wykorzystanie materiału skrawającego
- Brak kosztów logistycznych związanych z wysyłką narzędzia do producenta w celu regeneracji
- Mniejsza rotacja narzędzi i niskie koszty regeneracji
- Łatwe obracanie i wymiana płytek skrawających

Cechy charakterystyczne narzędzia

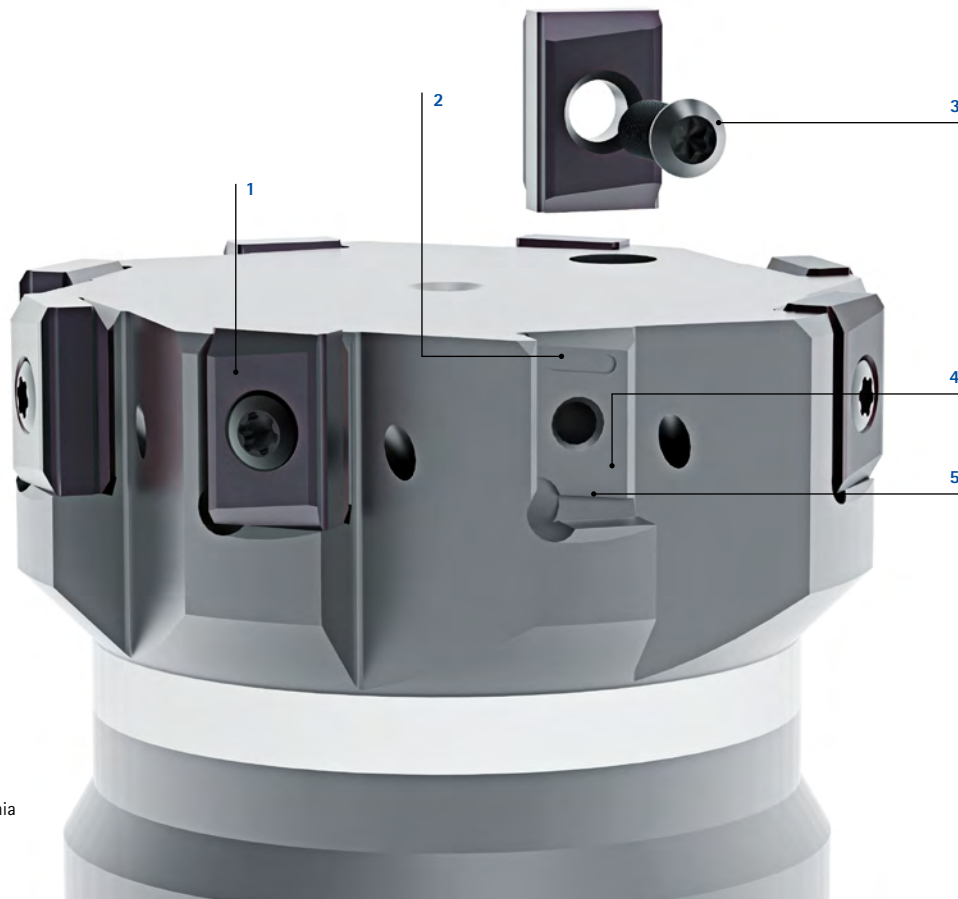

1 Płytkę skrawającą

Czteroostrowa dla wysokiej ekonomiczności

2 Przestrzeń na zabrudzenia

Do usuwania mikrozabrudzeń

3 Śruba TORX® PLUS

4 Gniazdo płytki

Wysoka dokładność dla optymalnego spełnienia tolerancji

5 Rowek na zabrudzenia

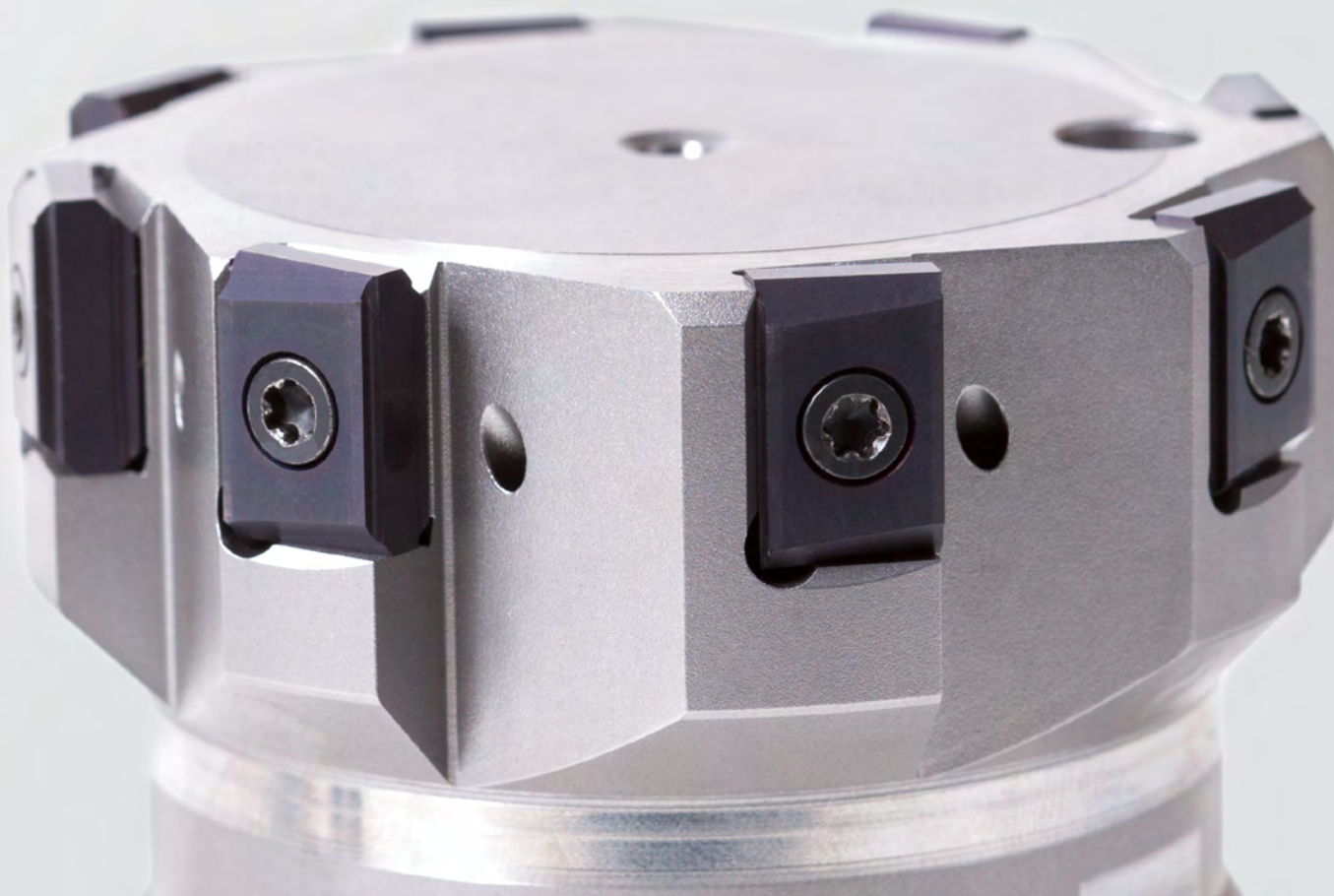

HPR400 plus



Wymiana ostrzy na miejscu przez klienta

- Prosta obsługa
- Precyzyjna wymiana ostrzy dzięki bardzo dokładnemu gniazdu płytki
- Brak konieczności regulacji



Cztery krawędzie skrawające dla wysokiej ekonomiczności

- Dostępne różne materiały skrawające i nakroje
- Nakroje specjalne dostępne na zapytanie

IT10					
IT9					
IT8					
IT7					
IT6					
IT5					
IT4					
	65,001 - 80,000	80,001 - 120,000	120,001 - 180,000	180,001 - 250,000	250,001 - 315,000

Tolerancja IT7 od średnicy 65 mm

- Bezproblemowa realizacja klasy tolerancji IT7, jak również klas niższych, dla większych średnic

Rozwiertak wysoko wydajny HPR400 plus

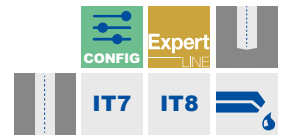
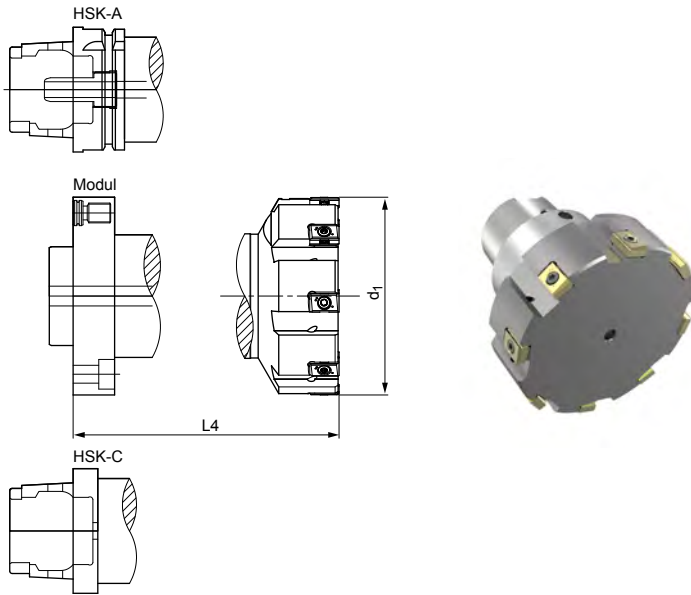

Rozmiary korpusów HPR400 plus

d ₁	z	Wielkość chwytu				
		HSK-C	HSK-A	Dowolna wartość wysięgu L4	Moduł	Dowolna wartość wysięgu L4
63,000 - 79,999	8	HSK-C063	HSK-A063	65-290	60	65-320
80,000 - 99,999	8	HSK-C063	HSK-A063	65-290	80	65-320
100,000 - 124,999	8	HSK-C080	HSK-A080	75-330	100	75-320
125,000 - 159,999	8	HSK-C080	HSK-A080	75-330	100	75-320
160,000 - 199,999	8	HSK-C080	HSK-A080	75-330	140	90-320
200,000 - 249,999	10	HSK-C100	HSK-A100	90-300	140	90-320
250,000 - 319,999	12	HSK-C100	HSK-A100	90-300	140	90-320

Dane mają wyłącznie charakter orientacyjny, inne wymiary dostępne na zapytanie

Możliwość konfiguracji parametrów



- Możliwość wyboru średnicy w krokach co 0,001 mm
- Dostępne od tolerancji IT7 - IT8 (min. 40 µm)
- Możliwość zastosowania wszystkich typowych chwytów jako złączy
- Możliwość wykonania w wariantach stopniowym
- Możliwość łączenia z innymi systemami narzędzi MAPAL i chwytów MAPAL
- Możliwość zastosowania systemu smarowania mgiełką

Specyfikacja:
Na zapytanie

Osprzęt i części zamienne	Numer katalogowy
Zestaw kluczy dynamometrycznych 1-5 Nm	30415174
Śruba zamienna M4x12	10018468

Wymiary podano w mm.

Inne nakroje i materiały skrawające dostępne na zapytanie.

Płytki skrawające do systemu HPR400 plus



Seria preferowana ostrzy

Zakres średnicy	Numer katalogowy
63,000 - 79,999	30968871
80,000 - 99,999	30933385
100,000 - 124,999	30968884
125,000 - 159,999	30968891
160,000 - 199,999	30968898
200,000 - 249,999	30968905
250,000 - 319,999	30968912

Wersja:

Zakres średnicy: 63,000 - 319,999
 Cztery krawędzie skrawające
 Nakrój: 45° x 0,55 mm
 Materiał skrawający: HC419



Seria preferowana ostrzy

Zakres średnicy	Numer katalogowy
63,000 - 79,999	31315612
80,000 - 99,999	31315613
100,000 - 124,999	31149561
125,000 - 159,999	31315614
160,000 - 199,999	31315615
200,000 - 249,999	31315617
250,000 - 319,999	31315618

Wersja:

Zakres średnicy: 63,000 - 319,999
 Cztery krawędzie skrawające
 Nakrój: 30° x 0,60 mm + kąt
 ścinania
 Materiał skrawający: CP004
 Grupa materiałowa K
 Odpowiednie do powierzchni Ra < 2 μm

Wymiary podano w mm.

Inne nakroje i materiały skrawające dostępne na zapytanie.

HPR400

Rozwiercanie dużych średnic z łatwą wymianą ostrzy na miejscu

Dzięki specjalnym, wysoce precyzyjnym gniazdom płytek, w przypadku narzędzi z typoszeregu HPR400 użytkownicy mogą samodzielnie wymieniać ostrza bezpośrednio na miejscu za pomocą klucza dynamometrycznego. Nieprawidłowy montaż jest wykluczony, ponieważ możliwe jest tylko jedno położenie montażowe, a ostrza mogą być montowane w dowolnej pozycji. Eliminuje to nie tylko nakład pracy związany z regulacją, ale również konieczność wysyłki narzędzi do regeneracji. Użytkownicy muszą jedynie posiadać zapas ostrzy MAPAL. Ilość potrzebnych narzędzi jest niewielka, gdyż korpusy narzędzi nie wymagają przygotowania. Przy minimalnym nakładzie czasu i niewielkiej rotacji narzędzi, system HPR400 pozwala użytkownikowi uzyskać bardzo dokładne otwory.

Ostrza są optymalnie dostosowane do obrabianego materiału i rodzaju obróbki. System HPR400 jest dostępny w zakresie średnic od

63 do 319,999 mm z chwytem HSK lub własnym chwytem modułowym firmy MAPAL. MAPAL oferuje różne płytki skrawające z węgla spiekane, z powłoką CVD lub bez niej, wykonane z cermetu i z ostrzami PCD lub PcBN.

W SKRÓCIE

- Samodzielna wymiana ostrzy przez użytkownika na miejscu
- Przyporządkowanie ostrzy niezależnie od gniazda płytki
- Obniżenie kosztu jednostkowego części
- Obniżenie kosztów powłok
- Zmniejszenie rotacji narzędzi
- Możliwość wykorzystania wszystkich materiałów skrawających
- Tolerancja H7
- \varnothing 63,000 – 319,999 mm

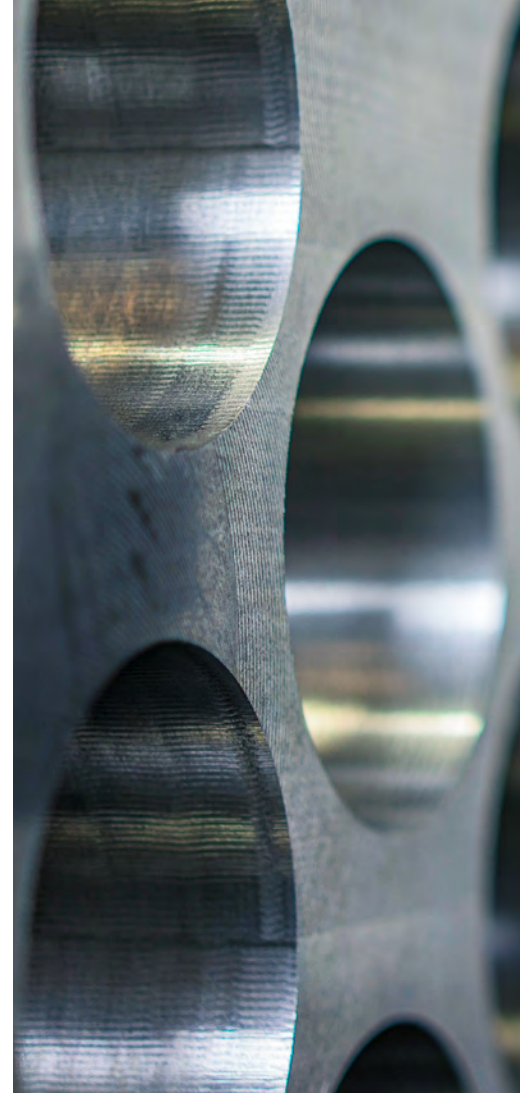

Cechy charakterystyczne narzędzia

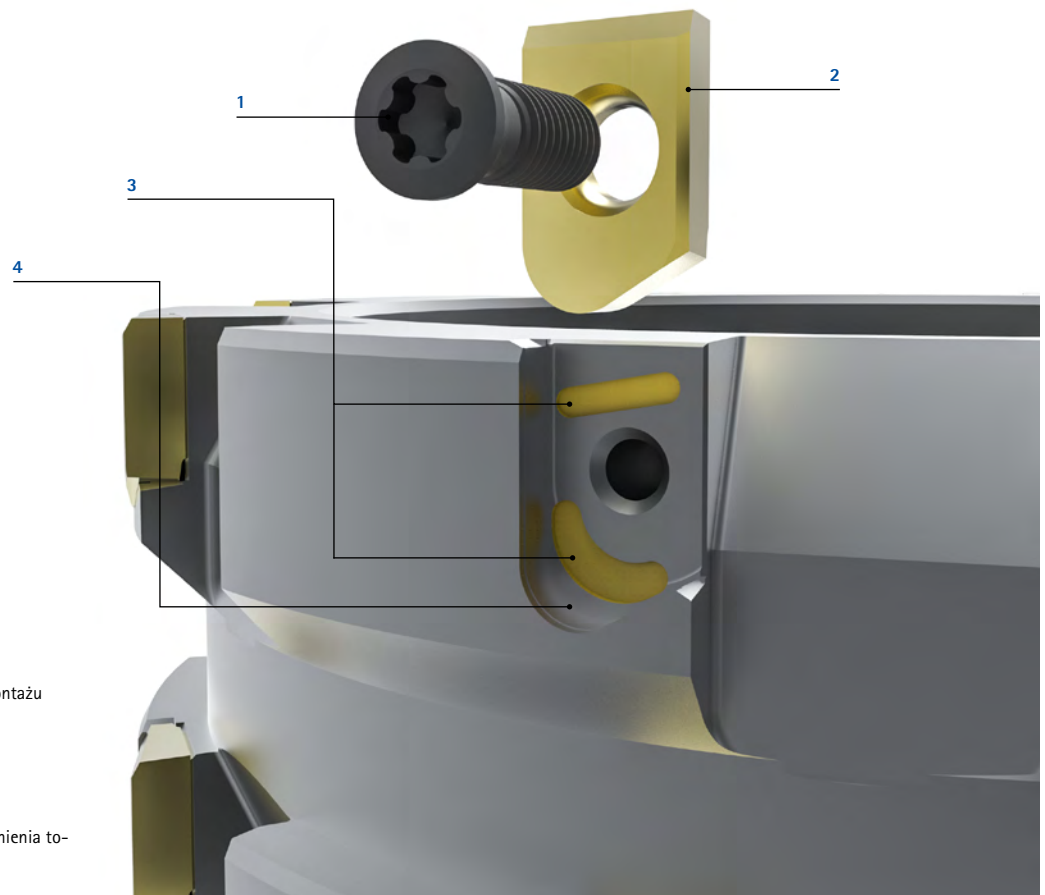

1 Śruba mocująca TORX®

2 Ostrze

Pryzmatyczny kształt dla optymalnego montażu

3 Przestrzeń na zabrudzenia

Do usuwania mikrozabrudzeń

4 Gniazdo płytki

Wysoka dokładność dla optymalnego spełnienia tolerancji

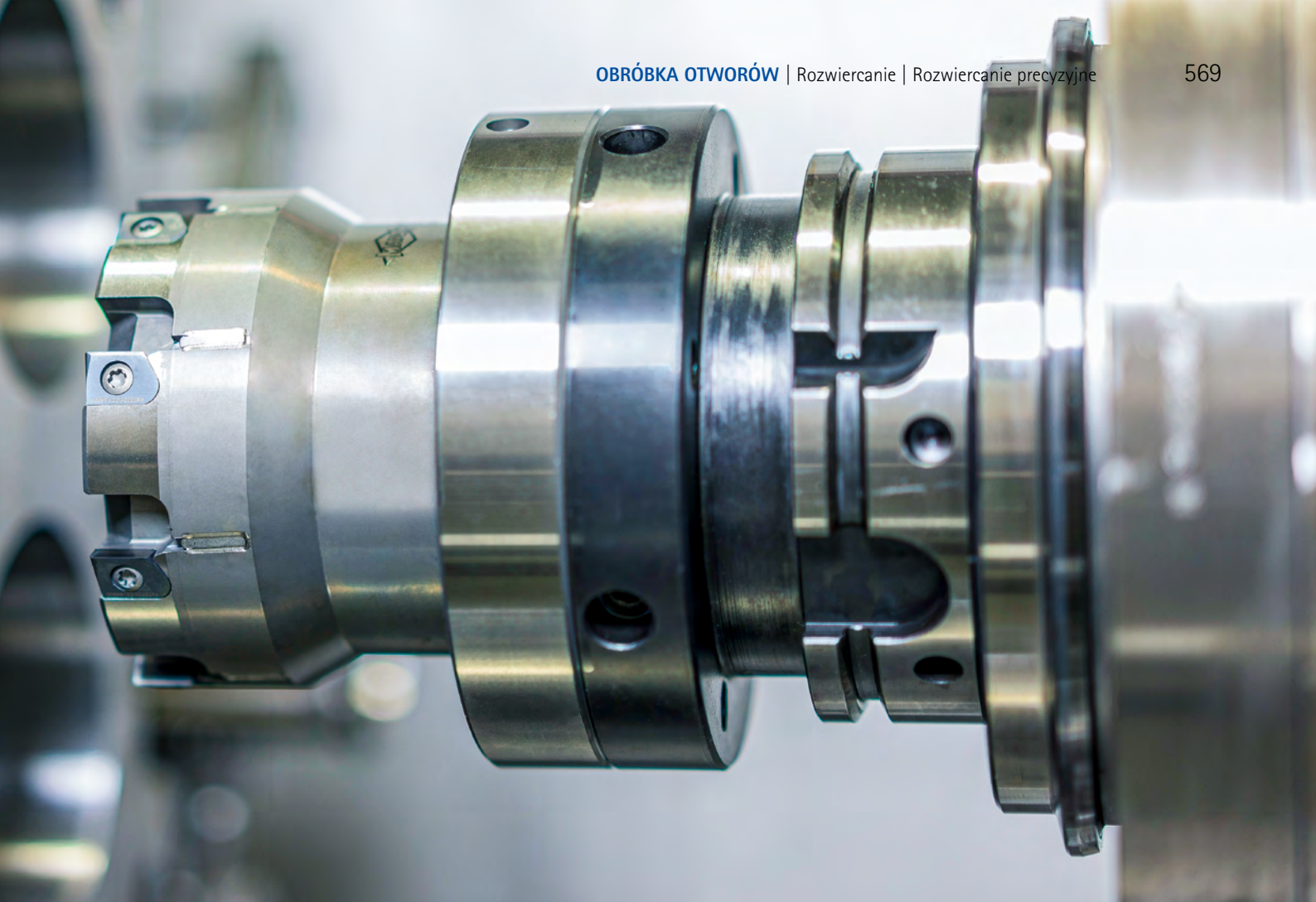

Ostrza z powłoką CVD



Optymalnie dopasowane do rozwiercania żeliw

Materiały skrawające z powłoką CVD dostępne dla systemu HPR400, oznaczone symbolem HC, zostały opracowane specjalnie do rozwiercania ciągliwych żeliw GJL, GJS i GJV, w trudnych warunkach obróbki, takich jak obróbka przerywana. Powłoka CVD wyróżnia się wysoką ciągliwością, a zarazem dobrą odpornością na zużycie. W przypadku ostrzy z powłoką CVD można osiągnąć nawet trzykrotnie dłuższą wytrzymałość narzędzi niż w przypadku dotychczasowych ostrzy z powłoką PVD, przy zachowaniu wysokiej stabilności procesu. Dzięki systemowi mocowania w narzędziach HPR400 można stosować niemal wszystkie pozostałe materiały skrawające.

Korzystna cena systemu



Łatwa wymiana ostrzy na miejscu

HPR400 firmy MAPAL to system, w którym wymiana ostrzy jest wykonywana na miejscu przez klienta. Wymienne ostrza są wsuwane osiowo do precyzyjnie przygotowanego gniazda płytki skrawającej oraz stabilnie i bardzo dokładnie mocowane śrubą TORX®. Ostrza można przy tym przyporządkować niezależnie od gniazda płytki. Koszty powłok są zredukowane przy jednoczesnym zmniejszeniu rotacji narzędzi.

Rozwiertak wysoko wydajny HPR400

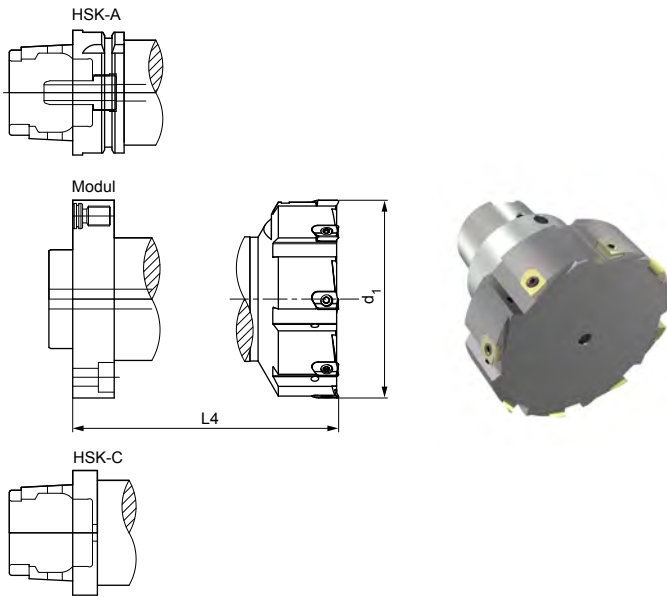

Rozmiary korpusów HPR400

d ₁	z	Wielkość chwytu				
		HSK-C	HSK-A	Dowolna wartość wysięgu L4	Moduł	Dowolna wartość wysięgu L4
63,000 - 79,999	8	HSK-C063	HSK-A063	65-290	60	65-320
80,000 - 99,999	8	HSK-C063	HSK-A063	65-290	80	65-320
100,000 - 124,999	8	HSK-C080	HSK-A080	75-330	100	75-320
125,000 - 159,999	8	HSK-C080	HSK-A080	75-330	100	75-320
160,000 - 199,999	8	HSK-C080	HSK-A080	75-330	140	90-320
200,000 - 249,999	10	HSK-C100	HSK-A100	90-300	140	90-320
250,000 - 319,999	12	HSK-C100	HSK-A100	90-300	140	90-320

Dane mają wyłącznie charakter orientacyjny, inne wymiary dostępne na zapytanie

Możliwość konfiguracji parametrów



- Możliwość wyboru średnicy w krokach co 0,001 mm
- Dostępne od tolerancji IT7
- Możliwe skrawanie czołowe
- Możliwość zastosowania wszystkich typowych chwytów jako złączy
- Możliwość wykonania w wariantcie stopniowym
- Możliwość łączenia z innym systemami narzędzi MAPAL i chwytów MAPAL
- Możliwość zastosowania systemu smarowania mgiełką

Specyfikacja: Na zapytanie

Osprzęt i części zamienne	Numer katalogowy
Zestaw kluczy dynamometrycznych 1-5 Nm	30415174
Śruba zamienna M3,5x9	10105078

Wymiary podano w mm.

Inne nakroje i materiały skrawające dostępne na zapytanie.

Płytki skrawające do systemu HPR400



Seria preferowana ostrzy

Zakres średnicy	Numer katalogowy
63,000 - 79,999	30916603
80,000 - 99,999	30794390
100,000 - 124,999	30809550
125,000 - 159,999	30788089
160,000 - 199,999	30809531
200,000 - 249,999	30938712
250,000 - 319,999	30931640

Wersja:

Zakres średnicy: 63,000 - 319,999
 Jedna krawędź skrawająca
 Nakrój: 45 ° x 0,55 mm
 Materiał skrawający: HC419



Seria preferowana ostrzy

Zakres średnicy	Numer katalogowy
63,00 - 79,99	31026872
80,00 - 99,99	31129899
100,00 - 124,99	31049249
125,00 - 159,99	30690096
160,00 - 199,99	31149706
200,00 - 249,99	31149707
250,00 - 319,99	31129911

Wersja:

Zakres średnicy: 63,000 - 319,999
 Jedna krawędź skrawająca
 Nakrój: 30° x 0,60 mm + kąt
 ścinania
 Materiał skrawający: CP004
 Grupa materiałowa K
 Odpowiednie do powierzchni Ra < 2 μm

Wymiary podano w mm.

Inne nakroje i materiały skrawające dostępne na zapytanie.

ROZWIĄZANIA SPECJALNE

Narzędzia z listwami prowadzącymi

Rozwiązania narzędziowe do konkretnych zastosowań

- 1 Nawiertak z listwami prowadzącymi i oprawką narzędziową ISO w konstrukcji lekkiej z aluminium do obróbki obudowy skrzyni biegów
- 2 Narzędzie do rozwiercania precyzyjnego z systemem płytek skrawających do łącznej obróbki wewnętrznej i zewnętrznej jarzma przekładni obiegowej
- 3 Rozwiertak zewnętrzny z systemem EasyAdjust i ostrzami TEC do obróbki kolektora wydechowego z uchwytem pływającym MAPAL
- 4 Narzędzie do rozwiercania precyzyjnego ze stopniem wstępnym ISO i złączem do głowicy rozwiercającej HPR, do obróbki bloku cylindrów
- 5 Narzędzie do rozwiercania precyzyjnego z systemem EasyAdjust z ostrzami HX do obróbki otworu łożyska wału korbowego
- 6 Narzędzie do rozwiercania precyzyjnego w lekkiej konstrukcji spawanej do obróbki obudowy przekładni
- 7 Wielostopniowe i wieloostrzowe narzędzie do rozwiercania precyzyjnego o lekkiej konstrukcji z tytanu do obróbki obudowy kierownicy
- 8 Narzędzie do rozwiercania precyzyjnego przeznaczone do smarowania minimalną ilością czynnika smarująco-chłodzącego (MMS) z systemem płytek skrawających do obróbki obudowy zasuwki sterującej
- 9 Wielostopniowe narzędzie do rozwiercania precyzyjnego z systemem płytek skrawających z ostrzami do obróbki konturowej i czołowej korpusu pompy
- 10 Narzędzie do rozwiercania precyzyjnego z systemem płytek skrawających do łącznej obróbki jarzma przekładni obiegowej
- 11 Styczne narzędzie do rozwiercania precyzyjnego do obróbki półwykończeniowej z modułową głowicą skrawającą do obróbki otworu łożyska wału korbowego
- 12 Rozwiertak zewnętrzny z systemem płytek skrawających, produkowany addytywnie jako konstrukcja lekka, do obróbki popychacza płyty sterującej.



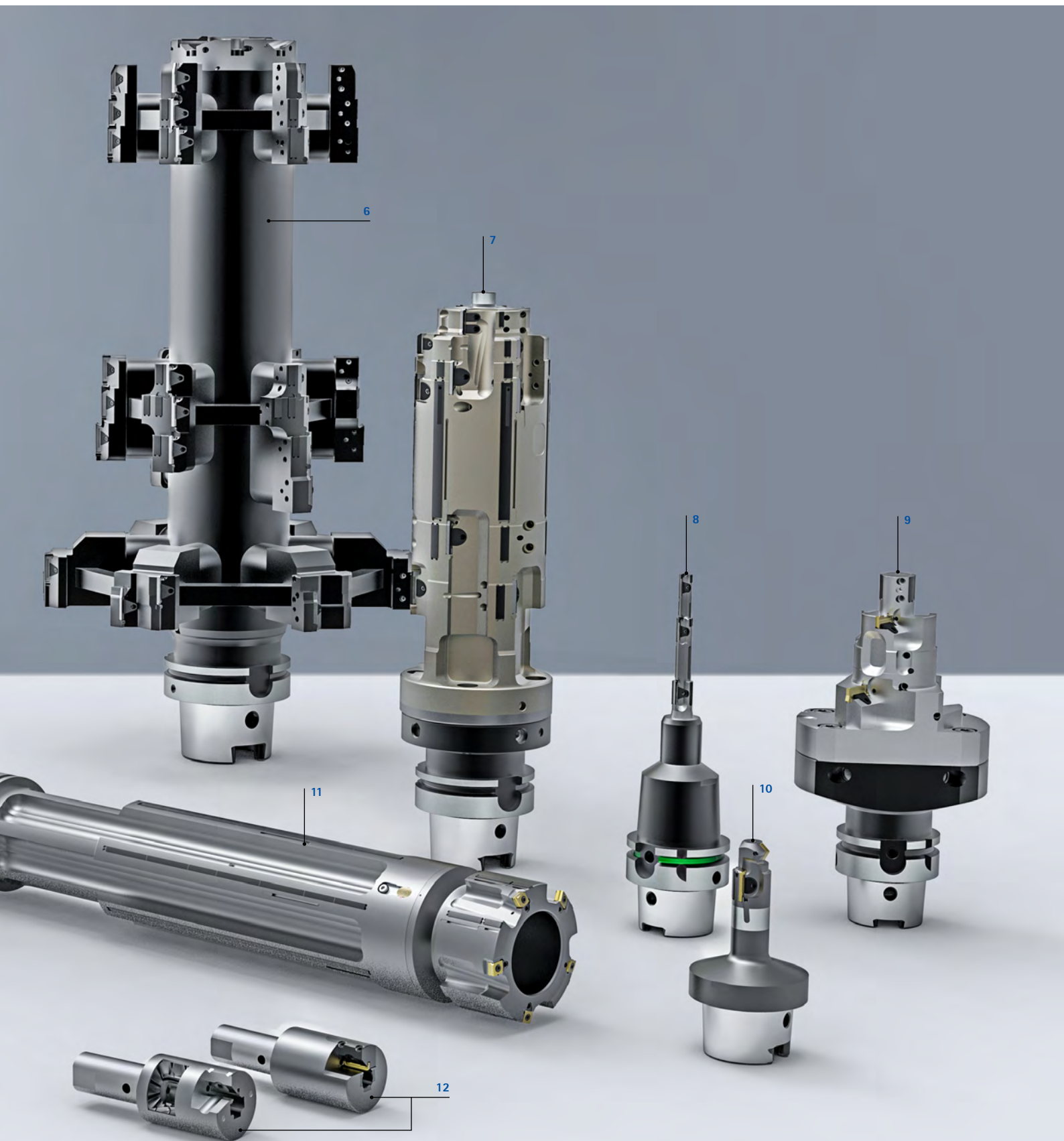

ROZWIĄZANIA SPECJALNE

Narzędzia z systemem EasyAdjust

Rozwiązania specjalne z systemem EasyAdjust

- 1 Narzędzia kombi do obróbki wstępnej i wykończeniowej dużego i małego ucha korbowodu. Z ostrzami ISO do obróbki wstępnej i systemem EasyAdjust do obróbki wykończeniowej
- 2 Narzędzie specjalne z systemem EasyAdjust z czterema ostrzami TEC (z = 4) i jednostronnie ułożonymi listwami prowadzącymi, do mocno przerywanego skrawania korpusu pompy wykonanego z GJS-400
- 3 Sześciostrojowe narzędzie o podziałce 4+2 z systemem EasyAdjust z ostrzami HX do obróbki otworu walcowego
- 4 Wielostopniowe narzędzia do rozwiercania precyzyjnego z systemem EasyAdjust z ostrzami TEC do obróbki otworów nieprzelotowych o wymaganiach pod względem dokładności wymiarowej IT5 i IT6 w obudowach przekładni i zaworów
- 5 Narzędzia do obróbki półwykończeniowej i wykończeniowej otworu łożyska wału korbowego z kombinacji bimetalu aluminium-GJL
- 6 Rozwiertak zewnętrzny z systemem EasyAdjust z ostrzami TEC zastępuje konwencjonalne toczenie elementu wykonanego z GJS, zapewniając lepszą dokładność wymiarową

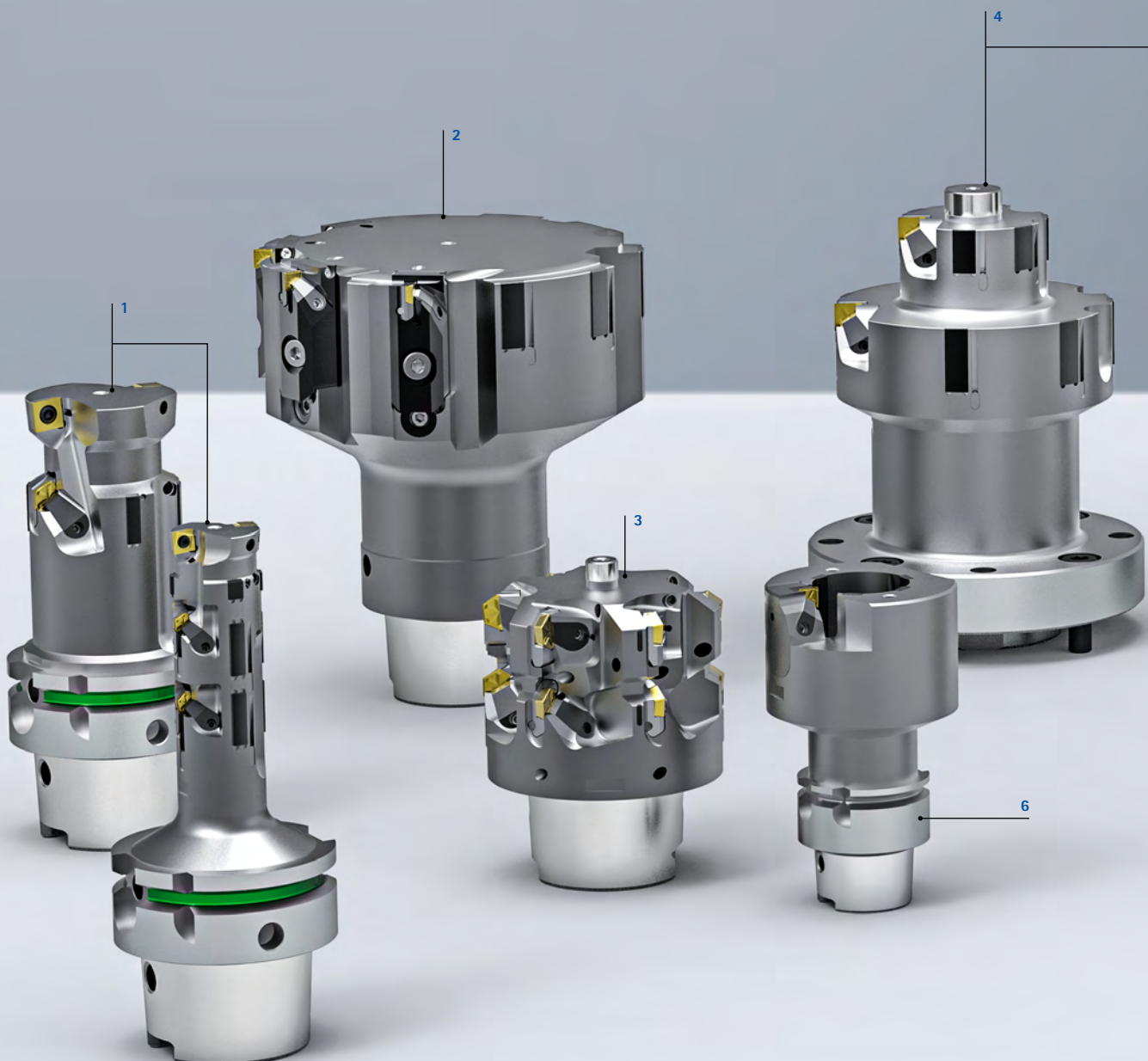

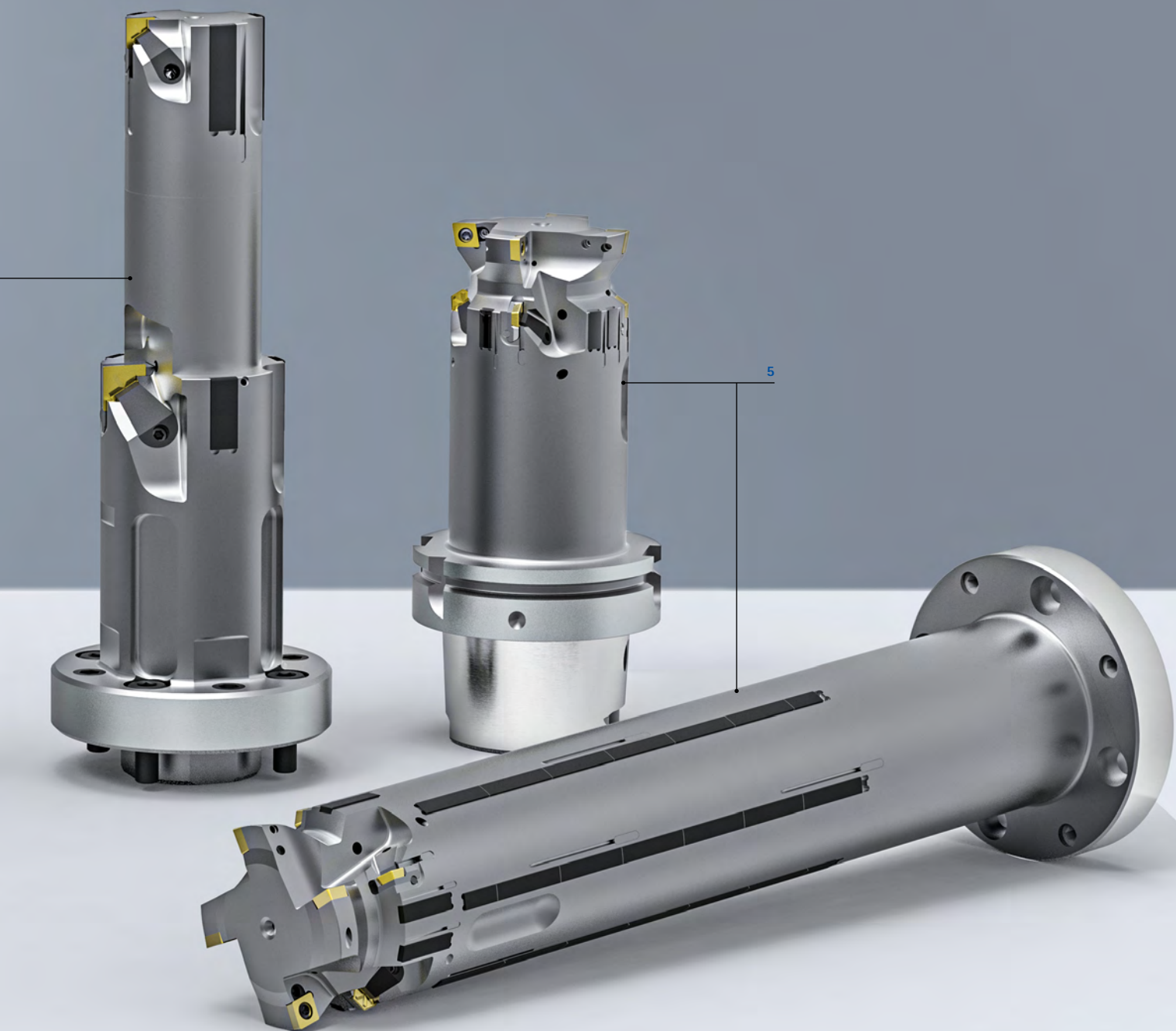

ROZWIĄZANIA SPECJALNE

Rozwiertaki wielostrzowe



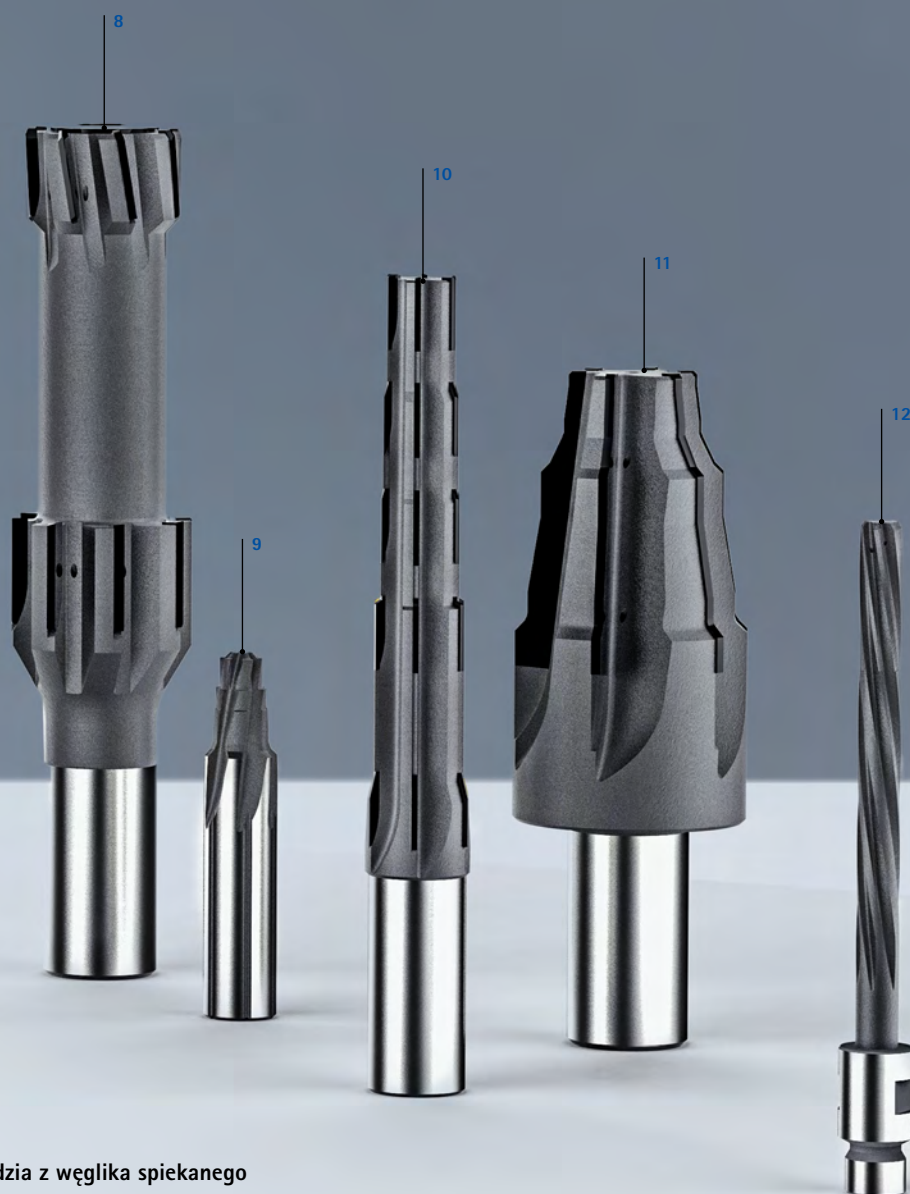

Rozwiązania specjalne – narzędzia z węgla spiekane

- 1 Dwustopniowe narzędzie specjalne z lutowanymi ostrzami do obróbki obudowy hydraulicznej z EN-GJS-500-7
- 2 Wielostopniowe, powlekane narzędzie specjalne z węgla spiekane z obróbką faz i promieni do obróbki stalowego uchwyty cylindra
- 3 Rozwiertak stopniowy z węgla spiekane z powłoką, do obróbki otworu wtryskiwacza w głowicy cylindra
- 4 Rozwiertak stopniowy z węgla spiekane z powłoką, do obróbki wykończeniowej konturu otworu świecy zapłonowej z EN-GJL-250
- 5 Dwustopniowy rozwiertak stopniowy z węgla spiekane z dodatkowym fazowaniem do obróbki pompy wysokociśnieniowej ze stali nierdzewnej
- 6 Stożkowy rozwiertak maszynowy HSS z chwytem MK
- 7 Rozwiertak stopniowy z węgla spiekane o geometrii VA do obróbki bloku zaworowego ze stali nierdzewnej
- 8 Dwustopniowy rozwiertak specjalny z lutowanymi ostrzami z cermetu z kombinacją rowków prostych i lewoskrętnych
- 9 Powlekany rozwiertak wielostopniowy z węgla spiekane z chłodzeniem wewnętrznym na chwycie, do obróbki szyny
- 10 Dwustopniowy rozwiertak z lutowanymi, półokrągłymi, osadzonymi ostrzami z cermetu, do obróbki stalowego uchwyty dyszy
- 11 Powlekany rozwiertak z końcówkami z węgla spiekane do obróbki specjalnych elementów toczonych
- 12 Rozwiertak wysoko wydajny z lutowaną doczołowo głowicą z węgla spiekane oraz chwytem specjalnym do obróbki otworów pod nitę. Obróbka materiału kombinowanego: tytan, aluminium i stal wysokostopowa. Zastosowanie przemysł lotniczy

ROZWIĄZANIA SPECJALNE

HPR – High-Performance-Reamer





Rozwiązania specjalne – HPR

- 1 Rozwiązanie specjalne z modułowym pierścieniem wielostrzowym HPR i rozwiertakiem stopniowym z węgla spiekane go z produkowanym addytywnie uchwytem z technologią rozprężania hydraulicznego do mocowania wewnętrznego i zewnętrznego przy obróbce gniazd zaworów
- 2 Wielostopniowe, modułowe narzędzie kombi ze zintegrowanym złączem CFS do stałego, lutowanego narzędzia CPR z ostrzami stycznymi ISO do obróbki wstępnej i systemem HPR300 do obróbki wykończeniowej zacisku hamulcowego
- 3 Wielostopniowe narzędzie specjalne z ostrzem PCD i częścią pogłębiającą do obróbki elementów w przemyśle lotniczym
- 4 Wielostopniowe narzędzie specjalne HPR ze złączem HFS do obróbki otworu i pogłębiania konturu turbosprężarki z GJL250
- 5 Wielostopniowe narzędzie specjalne ze stycznie ułożonymi ostrzami rozwiercającymi do obróbki obudów
- 6 Narzędzie specjalne do obróbki otworów pod nity w przemyśle lotniczym
- 7 Prawe narzędzie skrawające do obróbki otworów nieprzelotowych
- 8 Wielostopniowe narzędzie specjalne ze specjalną geometrią ostrzy i złączem HFS
- 9 Narzędzie specjalne w wersji stałej z lutowanymi ostrzami do obróbki stopniowej przejść czołowych i fazowych otworu siłownika w zacisku hamulcowym

ROZWIĄZANIA SPECJALNE

Rozwiertaki wielostrzowe do otworów o dużych średnicach

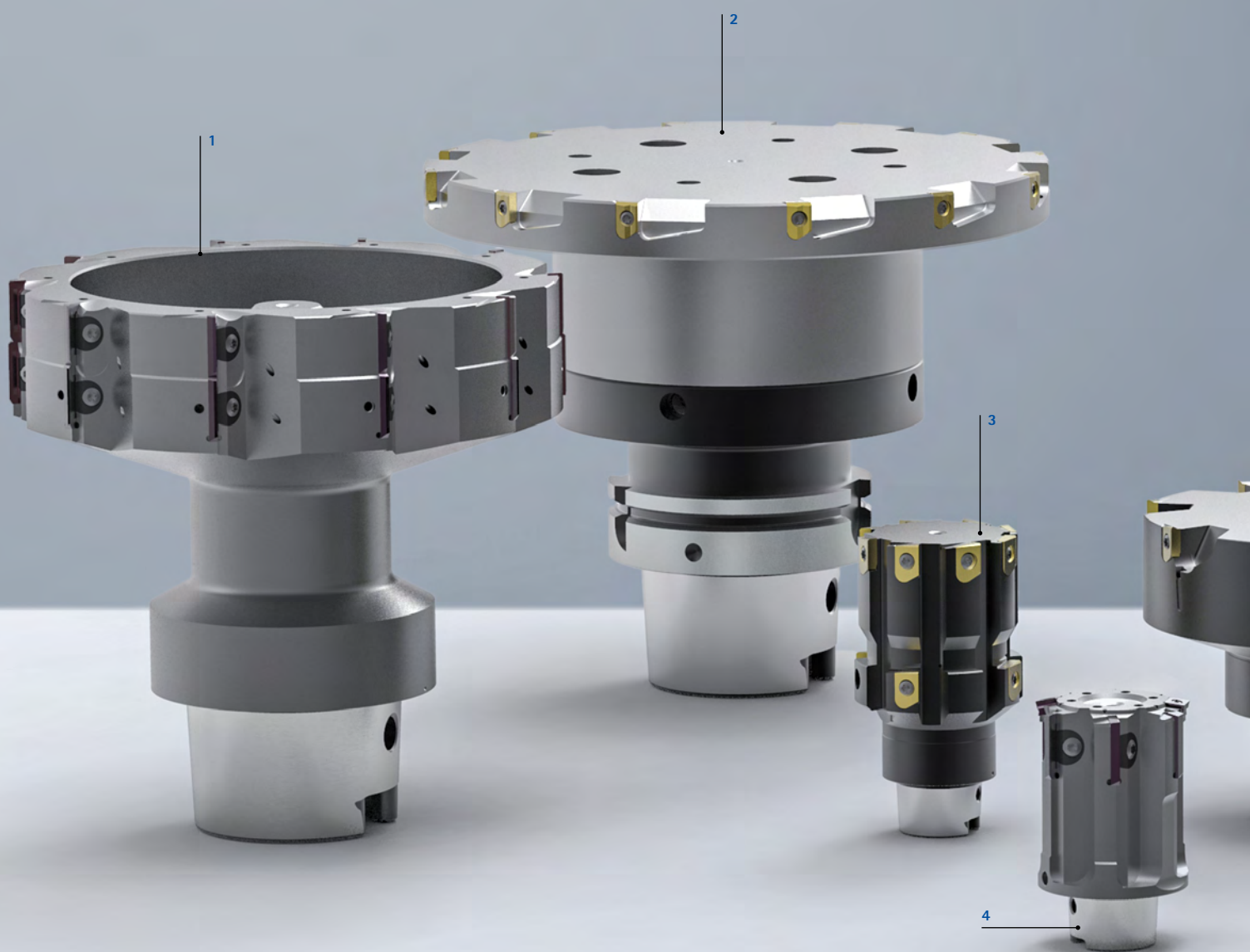

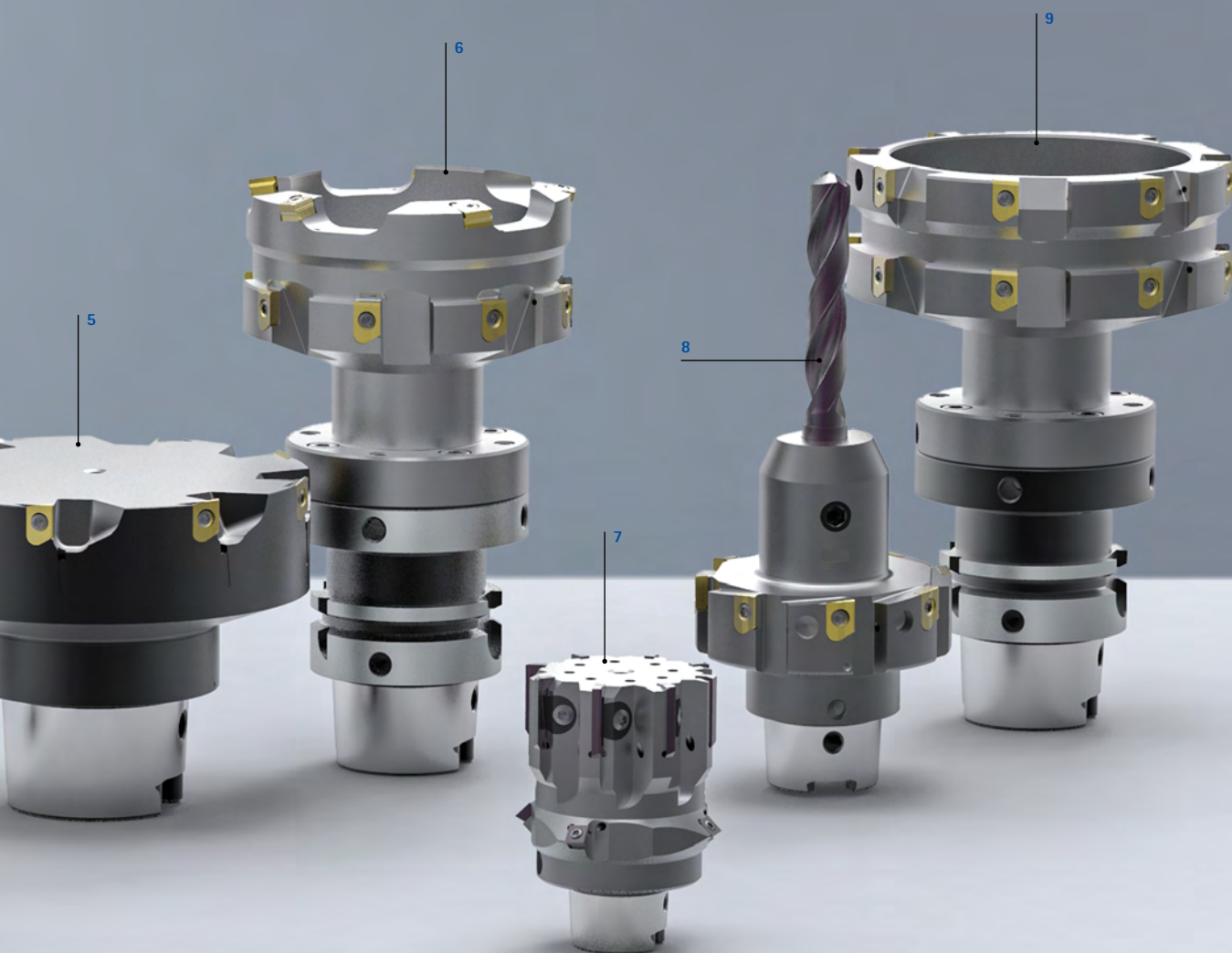

Rozwiązania specjalne – HPR300 i HPR400

- 1 Dwustopniowe rozwiązanie specjalne HPR300 do obróbki otworu łożyskowego obudowy przekładni
- 2 HPR400 z ostrzami z powłoką CVD, o średnicy 160 mm, do obróbki obudowy mechanizmu różnicowego z regulowanym złączem modułowym
- 3 Dwustopniowe narzędzie HPR400 z ośmioma ostrzami do otworu tłoka i czterema ostrzami do wykroju kontrolnego zacisku hamulcowego
- 4 Narzędzie kombi z ostrzami stycznymi ISO do obróbki wstępnej i HPR300 z ostrzami PCD do obróbki wykończeniowej tulei mosiężnej
- 5 Narzędzie specjalne HPR400 do otworu mostu osi wykonane z GJS-400 ze specjalnymi ostrzami CVD do obróbki gniazda łożyska i wcięć osiowych
- 6 Narzędzie kombi o konstrukcji lekkiej z regulowanym złączem modułowym na adapterze HSK do obróbki obudowy przekładni stożkowej. Z ostrzami stycznymi ISO do obróbki wstępnej i systemem HPR400 do obróbki wykończeniowej
- 7 HPR300 z fazowaniem
- 8 Narzędzie kombi z wiertłem wtykowym z węgla spiekane go i stopniem rozwiercania HPR400 do obróbki łożyska wychylnego
- 9 Narzędzie stopniowe HPR400 o konstrukcji lekkiej z regulowanym złączem modułowym do obróbki obudowy napędu przekładni stożkowej



POGŁĘBIANIE

Pogłębianie za pomocą pogłębiaczy stożkowych o ekstremalnie nierównomierniej podziałce. Optymalne pogłębianie – spokojnie, szybko i dokładnie.



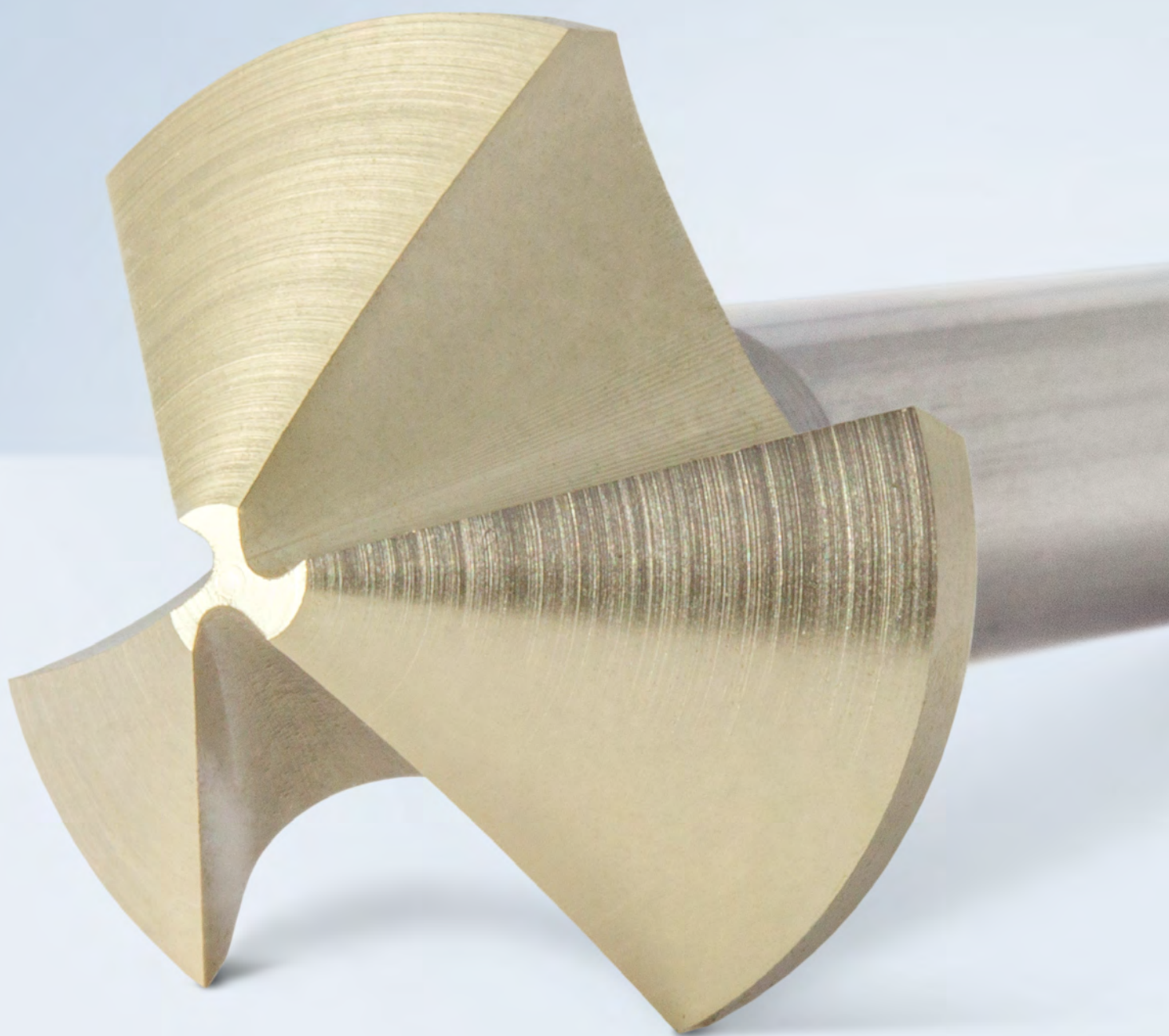

POGŁĘBIACZE STOŻKOWE O EKSTREMALNIE NIERÓWNIOMIERNEJ PODZIAŁCE

Wstęp

Technologia 586

Pogłębiacze stożkowe

Wariant HSS z powłoką 588

Wariant z węgla spiekanego z powłoką 589





POGŁĘBIACZ STOŻKOWY O EKSTREMALNIE NIERÓWNOMIERNEJ PODZIAŁCE

Wreszcie spokojnie, szybko i dokładnie

Potencjał do zwiększenia produktywności dotyczy wszystkich procesów obróbki, także tych pozornie mniej ważnych. Dowodzą tego pogłębiacze stożkowe MAPAL.

Pogłębiacze stożkowe pracują ze znacznie zredukowaną siłą poosiową. Ich ostrza charakteryzują się nierównomierną podziałką. Przy wybranym przełożeniu siła poosiowa zostaje zredukowana o ponad 50 procent, a siła promieniowa o 25 procent w porównaniu z konwencjonalnymi pogłębiaczami stożkowymi. Zoptymalizowane w ten sposób warunki za

stosowania generują znacznie mniej wibracji w narzędziu, dzięki czemu uzyskiwane są wyższe dokładności i lepsze jakości powierzchni. Precyzja pogłębienia prowadzi do uzyskania lepszego przylegania połączeń śrubowych i nitowych, a w efekcie polepszenia ich stabilności pod obciążeniem. Natomiast zmniejszone obciążenie obrabiarki zwiększa trwałość narzędzia. Dzięki cichej i stabilnej pracy pogłębiacze te mogą być stosowane z wyższymi parametrami skrawania, co przyczynia się do znacznej oszczędności czasu.



Cechy charakterystyczne narzędzia

Zredukowana siła promieniowa o 25%

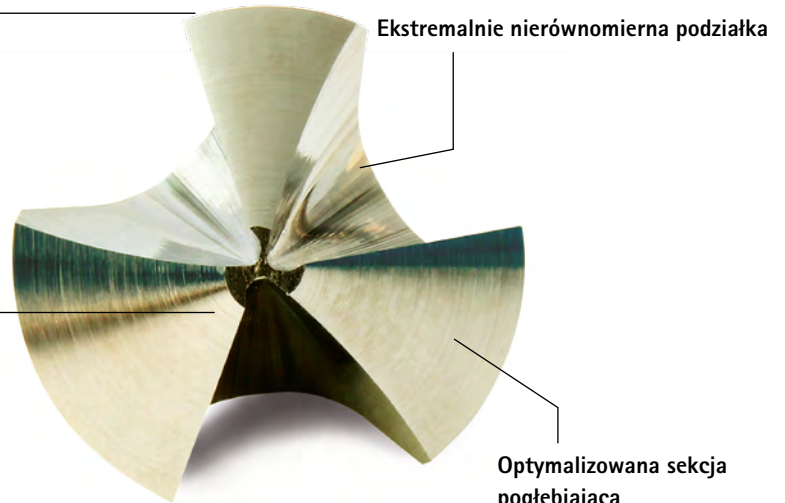
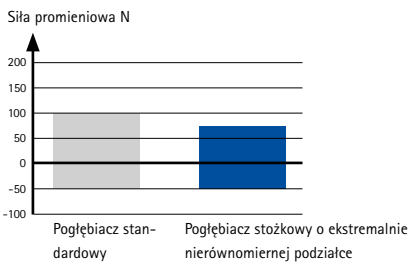

Zredukowana siła poosiowa o 50%

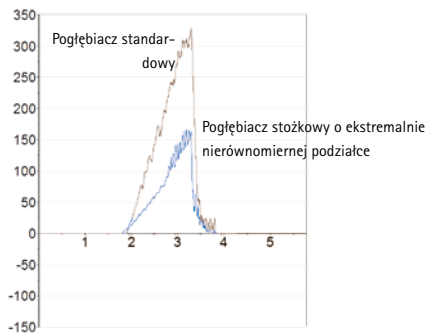

Pogłębiacz stożkowy o ekstremalnie nierównomiernej podziałce



Pogłębiacz standardowy

Wersja HSS z powłoką

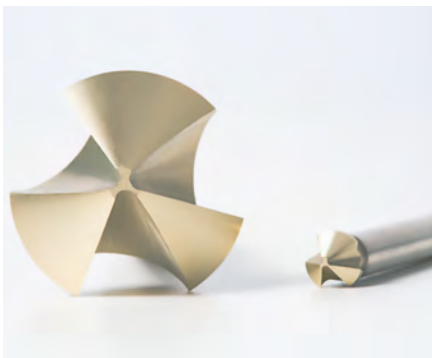

W przypadku wszystkich typowych materiałów obrabianych, takich jak stal, Inox czy aluminium, narzędziem wyboru są pogłębiacze stożkowe w wykonaniu HSS z powłoką o wysokiej wydajności. Powłoka gwarantuje dużą wytrzymałość. Narzędzia pracują niezawodnie i stabilnie nawet przy dużych prędkościach skrawania. Do bardziej wymagających materiałów obrabianych zaleca się stosowanie wersji z węglika spiekanego.

Wersja z powłoką z węglika spiekanego



Oprócz wysokowydajnych, powlekanych wersji pogłębiaczy stożkowych HSS MAPAL oferuje również wybrane średnice w wersji z węglika spiekanego z powłoką. Oprócz zalet nierównomiernej podziałki wersja z węglika spiekanego zapewnia dodatkową wartość dodaną, zwłaszcza przy obróbce wymagających materiałów obrabianych, takich jak tytan, żeliwo wysokostopowe, Inconel lub CFK. Wyższa wytrzymałość narzędzia i wyższe prędkości skrawania w porównaniu do wersji powlekanej HSS są osiągnięte przy zachowaniu stabilności procesu.

Wersje specjalne wiertel z częścią pogłębiającą



W PRZYPADKU WIELU WIERTEL Z WĘGLIKA SPIEKANEGO MAPAL oferuje możliwość wykonania jako rozwiązania specjalnego z częścią pogłębiającą. Oznacza to, że do wykonania obu operacji obróbki: wiercenia i pogłębiania wystarczy jedno narzędzie, natomiast czas nieproduktywny zostaje zredukowany. Najnowocześniejsze technologie i elastyczna produkcja w firmie MAPAL umożliwiają krótkie terminy dostaw rozwiązań specjalnych na całym świecie.

Pogłębiacz stożkowy 90°

Wersja z HSS z powłoką, o ekstremalnie nierównomiernej podziałce COS110

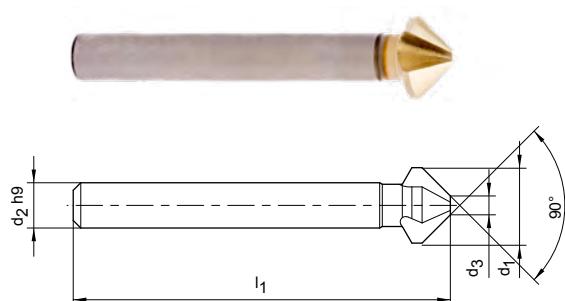

Wymiary					Specyfikacja	Nr materiałowy
d ₁	d ₂	d ₃	l ₁	z		
4,30	4	1,3	40	3	COS110-0430-335C-SP345	30662991
6,00	5	1,5	45	3	COS110-0600-335C-SP345	30662992
6,30	5	1,5	45	3	COS110-0630-335C-SP345	30633783
8,00	6	2,0	50	3	COS110-0800-335C-SP345	30662993
8,30	6	2,0	50	3	COS110-0830-335C-SP345	30662994
10,00	6	2,5	50	3	COS110-1000-335C-SP345	30662996
10,40	6	2,5	50	3	COS110-1040-335C-SP345	30633784
11,50	8	2,8	56	3	COS110-1150-335C-SP345	30662997
12,40	8	2,8	56	3	COS110-1240-335C-SP345	30662998
15,00	10	3,2	60	3	COS110-1500-335C-SP345	30662999
16,50	10	3,2	60	3	COS110-1650-335C-SP345	30633786
19,00	10	3,5	63	3	COS110-1900-335C-SP345	30663000
20,50	10	3,5	63	3	COS110-2050-335C-SP345	30633787
23,00	10	3,8	67	3	COS110-2300-335C-SP345	30663001
25,00	10	3,8	67	3	COS110-2500-335C-SP345	30633788
31,00	12	4,2	71	3	COS110-3100-335C-SP345	30663003



Zestaw pogłębiaczy stożkowych

d ₁	Specyfikacja	Nr materiałowy
6,30 - 25,00	COS110-6.3-25-335C-SP345-SET W skład zestawu wchodzi ø 6,30 mm ø 10,4 mm ø 16,5 mm ø 20,5 mm ø 25,0 mm	30634356

Wymiary podano w mm.

Zalecane parametry skrawania – patrz koniec rozdziału.

Pogłębiacz stożkowy 90°

Wersja z węgla spiekanego z powłoką, o ekstremalnie nierównomiernej podziałce COS110

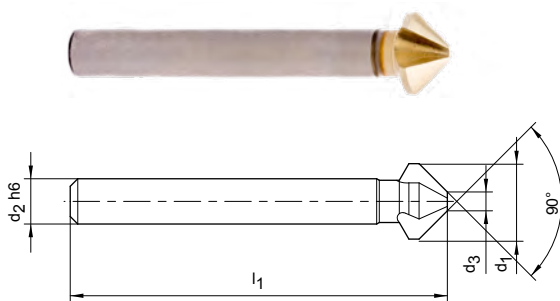

Wymiary					Specyfikacja	Nr materiałowy
d ₁	d ₂	d ₃	l ₁	z		
6,30	5	1,5	45	3	COS110-0630-335C-HP437	30799189
8,30	6	2,0	50	3	COS110-0830-335C-HP437	30799191
10,40	6	2,5	50	3	COS110-1040-335C-HP437	30799192
12,40	8	2,8	56	3	COS110-1240-335C-HP437	30799195
16,50	10	3,2	60	3	COS110-1650-335C-HP437	30799198
20,50	10	3,5	63	3	COS110-2050-335C-HP437	30799199
25,00	10	3,8	67	3	COS110-2500-335C-HP437	30799201
31,00	12	4,2	71	3	COS110-3100-335C-HP437	30799203

Wymiary podano w mm.

Zalecane parametry skrawania – patrz koniec rozdziału.

Zalecane parametry skrawania dla pogłębiaczy stożkowych

Pogłębiacze stożkowe o ekstremalnie nierównomiernej podziałce – wersja z HSS z powłoką
Posuw i prędkość skrawania

MZG*	Materiał obrabiany	Wytrzymałość/twardość [N/mm ²] [HRC]
P	P1.1 Stale konstrukcyjne, użytkowe i uszlachetnione, stale niestopowe	< 700
	P1.2 Stale konstrukcyjne, użytkowe i uszlachetnione, stale niestopowe	< 1 200
	P2.1 Stale azotowane, użytkowe i uszlachetnione, stale stopowe	< 900
	P2.2 Stale azotowane, użytkowe i uszlachetnione, stale stopowe	< 1 400
	P3.1 Stale narzędziowe, łożyskowe, sprężynowe i stale szybko tnące**	< 800
	P3.2 Stale narzędziowe, łożyskowe, sprężynowe i stale szybko tnące**	< 1 000
	P3.3 Stale narzędziowe, łożyskowe, sprężynowe i stale szybko tnące**	< 1 500
	P4.1 Stale nierdzewne, ferrytyczne i martenzytyczne	
	P5.1 Staliwo	
	P6.1 Staliwo nierdzewne, ferrytyczne i martenzytyczne	
M	M1.1 Stale nierdzewne, austenityczne	< 700
	M1.2 Stale nierdzewne, ferrytyczne/austenityczne (Duplex)	< 1 000
	M2.1 Staliwo nierdzewne, austenityczne	< 700
	M3.1 Staliwo nierdzewne, ferrytyczne/austenityczne (Duplex)	< 1 000
K	K1.1 Żeliwo z grafitem płatkowym (żeliwo szare), GJL	< 300
	K2.1 Żeliwo sferoidalne, GJS	< 500
	K2.2 Żeliwo sferoidalne, GJS	≤ 800
	K2.3 Żeliwo sferoidalne, GJS	> 800
	K3.1 Żeliwo wermikularne, GJV, (żeliwo ciągliwe), GJL	< 500
	K3.2 Żeliwo wermikularne, GJV, (żeliwo ciągliwe), GJL	> 500
N	N1.1 Aluminium, niestopowe i stopowe < 3 % Si	
	N1.2 Aluminium, stopowe ≤ 7 % Si	
	N1.3 Aluminium, stopowe > 7-12 % Si	
	N1.4 Aluminium, stopowe > 12 % Si	
	N2.1 Miedź, niestopowa i niskostopowa	< 300
	N2.2 Miedź, stopowa	> 300
	N2.3 Mosiądz, brąz, spiż	< 1 200
	N4.1 Tworzywo sztuczne, materiały termoplastyczne	
	N4.2 Tworzywo sztuczne, duroplast	
	N4.3 Tworzywo sztuczne, pianki	
S	S1.1 Tytan, stopy tytanu	< 400
	S2.1 Tytan, stopy tytanu	< 1 200
	S2.2 Tytan, stopy tytanu	> 1 200
	S3.1 Nikiel, niestopowy i stopowy	< 900
	S3.2 Nikiel, niestopowy i stopowy	> 900
	S4.1 Nadstop o wysokiej odporności termicznej na bazie Ni, Co i Fe	
	S5.1 Stopy wolframu i molibdenu	
H	H1.1 Stal utwardzana/staliwo	< 44
	H1.2 Stal utwardzana/staliwo	< 55

* Grupa materiałowa wg MAPAL

** Jeśli składniki stopu Cr, Mo, Ni, V, W wynoszą łącznie > 8 %, wybierz następną w kolejności grupę materiałową

Następna strona:
Wersja z węgla spiekane

	ø < 5 [mm]		ø < 5 - 8 [mm]		ø < 8 - 12 [mm]		ø < 12 - 16 [mm]		ø < 16 - 20 [mm]		ø < 20 - 25 [mm]		ø < 25 - 31 [mm]	
	v _c [m/min]	f [mm]	v _c [m/min]	f [mm]	v _c [m/min]	f [mm]	v _c [m/min]	f [mm]	v _c [m/min]	f [mm]	v _c [m/min]	f [mm]	v _c [m/min]	f [mm]
	40	0,06	40	0,08	40	0,10	40	0,12	40	0,14	40	0,18	40	0,22
	30	0,04	30	0,06	30	0,08	30	0,10	30	0,12	30	0,14	30	0,18
	30	0,04	30	0,06	30	0,08	30	0,10	30	0,12	30	0,14	30	0,18
	12	0,03	12	0,04	12	0,05	12	0,06	12	0,08	12	0,10	12	0,12
	30	0,04	30	0,06	30	0,08	30	0,10	30	0,12	30	0,14	30	0,18
	12	0,03	12	0,04	12	0,05	12	0,06	12	0,08	12	0,10	12	0,12
	15	0,04	15	0,05	15	0,06	15	0,07	15	0,08	15	0,09	15	0,12
	30	0,04	30	0,06	30	0,08	30	0,10	30	0,12	30	0,14	30	0,18
	15	0,04	15	0,05	15	0,06	15	0,07	15	0,08	15	0,09	15	0,12
	15	0,04	15	0,05	15	0,06	15	0,07	15	0,08	15	0,09	15	0,12
	10	0,04	10	0,05	10	0,06	10	0,07	10	0,08	10	0,09	10	0,12
	15	0,04	15	0,05	15	0,06	15	0,07	15	0,08	15	0,09	15	0,12
	20	0,06	20	0,10	20	0,12	20	0,14	20	0,18	20	0,20	20	0,25
	20	0,06	20	0,10	20	0,12	20	0,14	20	0,18	20	0,20	20	0,25
	20	0,06	20	0,10	20	0,12	20	0,14	20	0,18	20	0,20	20	0,25
	20	0,06	20	0,10	20	0,12	20	0,14	20	0,18	20	0,20	20	0,25
	20	0,06	20	0,10	20	0,12	20	0,14	20	0,18	20	0,20	20	0,25
	20	0,06	20	0,10	20	0,12	20	0,14	20	0,18	20	0,20	20	0,25
	50	0,08	50	0,10	50	0,12	50	0,14	50	0,18	50	0,22	50	0,26
	50	0,08	50	0,10	50	0,12	50	0,14	50	0,18	50	0,22	50	0,26
	40	0,08	40	0,10	40	0,12	40	0,14	40	0,18	40	0,22	40	0,26
	40	0,08	40	0,10	40	0,12	40	0,14	40	0,18	40	0,22	40	0,26
	40	0,10	40	0,12	40	0,14	40	0,18	40	0,20	40	0,24	40	0,30
	40	0,10	40	0,12	40	0,14	40	0,18	40	0,20	40	0,24	40	0,30
	40	0,10	40	0,12	40	0,14	40	0,18	40	0,20	40	0,24	40	0,30
	40	0,10	40	0,12	40	0,14	40	0,18	40	0,20	40	0,24	40	0,30
	40	0,10	40	0,12	40	0,14	40	0,18	40	0,20	40	0,24	40	0,30
	10	0,04	10	0,05	10	0,06	10	0,07	10	0,08	10	0,09	10	0,12
	10	0,04	10	0,05	10	0,06	10	0,07	10	0,08	10	0,09	10	0,12
	10	0,04	10	0,05	10	0,06	10	0,07	10	0,08	10	0,09	10	0,12
	10	0,04	10	0,05	10	0,06	10	0,07	10	0,08	10	0,09	10	0,12
	10	0,04	10	0,05	10	0,06	10	0,07	10	0,08	10	0,09	10	0,12
	10	0,04	10	0,05	10	0,06	10	0,07	10	0,08	10	0,09	10	0,12
	10	0,04	10	0,05	10	0,06	10	0,07	10	0,08	10	0,09	10	0,12
	6	0,04	6	0,05	6	0,06	6	0,08	6	0,08	6	0,10		
	6	0,04	6	0,05	6	0,06	6	0,08	6	0,08	6	0,10		

Podane parametry skrawania to wartości orientacyjne.

Optymalne wartości dla danego przypadku obróbki należy ustalić w ramach próby lub podczas obróbki.

Zalecane parametry skrawania dla pogłębiacza stożkowego

Pogłębiacze stożkowe o ekstremalnie nierównomiernej podziałce – wersja z węgla spiekanego z powłoką
Posuw i prędkość skrawania

MZG*	Materiał obrabiany	Wytrzymałość/twardość [N/mm ²] [HRC]
P	P1.1 Stale konstrukcyjne, użytkowe i uszlachetnione, stale niestopowe	< 700
	P1.2 Stale konstrukcyjne, użytkowe i uszlachetnione, stale niestopowe	< 1 200
	P2.1 Stale azotowane, użytkowe i uszlachetnione, stale stopowe	< 900
	P2.2 Stale azotowane, użytkowe i uszlachetnione, stale stopowe	< 1 400
	P3.1 Stale narzędziowe, łożyskowe, sprężynowe i stale szybko tnące**	< 800
	P3.2 Stale narzędziowe, łożyskowe, sprężynowe i stale szybko tnące**	< 1 000
P3.3 Stale narzędziowe, łożyskowe, sprężynowe i stale szybko tnące**	< 1 500	
P4	P4.1 Stale nierdzewne, ferrytyczne i martenzytyczne	
P5	P5.1 Staliwo	
P6	P6.1 Staliwo nierdzewne, ferrytyczne i martenzytyczne	
M	M1.1 Stale nierdzewne, austenityczne	< 700
	M1.2 Stale nierdzewne, ferrytyczne/austenityczne (Duplex)	< 1000
	M2.1 Staliwo nierdzewne, austenityczne	< 700
M3	M3.1 Staliwo nierdzewne, ferrytyczne/austenityczne (Duplex)	< 1 000
K	K1.1 Żeliwo z grafitem płatkowym (żeliwo szare), GJL	< 300
	K2.1 Żeliwo sferoidalne, GJS	< 500
	K2.2 Żeliwo sferoidalne, GJS	≤ 800
	K2.3 Żeliwo sferoidalne, GJS	> 800
	K3.1 Żeliwo wermikularne, GJV, (żeliwo ciągliwe), GJL	< 500
K3.2 Żeliwo wermikularne, GJV, (żeliwo ciągliwe), GJL	> 500	
N	N1.1 Aluminium, niestopowe i stopowe < 3 % Si	
	N1.2 Aluminium, stopowe ≤ 7 % Si	
	N1.3 Aluminium, stopowe > 7-12 % Si	
	N1.4 Aluminium, stopowe > 12 % Si	
	N2.1 Miedź, niestopowa i niskostopowa	< 300
	N2.2 Miedź, stopowa	> 300
	N2.3 Mosiądz, brąz, spiż	< 1 200
	N3.1 Grafit > 8 μm	
	N3.2 Grafit < 8 μm	
	N4.1 Tworzywo sztuczne, materiały termoplastyczne	
N4.2 Tworzywo sztuczne, duroplast		
N4.3 Tworzywo sztuczne, pianki		
C	C1.1 Matryca z tworzywa sztucznego, wzmocnionego włóknem aramidowym (AFK)	
	C1.2 Matryca z tworzywa sztucznego (duroplastycznego), CFK/GFK	
	C1.3 Matryca z tworzywa sztucznego (termoplastycznego), CFK/GFK	
	C2.1 Matryca węglowa, wzmocniana włóknem węglowym (CFC)	
	C3.1 Matryca metalowa (MMC)	
	C4.1 Konstrukcja typu sandwich, rdzeń w formie plastra miodu (Honeycomb)	
	C4.2 Konstrukcja typu sandwich, rdzeń piankowy	
	C5.1 Połączenie warstwowe (Stack), połączenie niemetal-metal nieżelazny	
	C5.2 Połączenie warstwowe (Stack), połączenie niemetal-metal	
	C5.3 Połączenie warstwowe (Stack), połączenie niemetal-niemetal	
	C5.4 Połączenie warstwowe (Stack), połączenie metal nieżelazny-metal nieżelazny	
	C5.5 Połączenie warstwowe (Stack), połączenie metal-metal nieżelazny	
C5.6 Połączenie warstwowe (Stack), połączenie metal-metal		
S	S1.1 Tytan, stopy tytanu	< 400
	S2.1 Tytan, stopy tytanu	< 1 200
	S2.2 Tytan, stopy tytanu	> 1 200
	S3.1 Nikiel, niestopowy i stopowy	< 900
	S3.2 Nikiel, niestopowy i stopowy	> 900
S4	S4.1 Nadstop o wysokiej odporności termicznej na bazie Ni, Co i Fe	
S5	S5.1 Stopy wolframu i molibdenu	
H	H1.1 Stal utwardzana/staliwo	< 44
	H1.2 Stal utwardzana/staliwo	< 55
	H2.1 Stal utwardzana/staliwo	< 60
	H2.2 Stal utwardzana/staliwo	< 65
	H2.3 Stal utwardzana/staliwo	< 68
H3	H3.1 Żeliwo / żeliwo utwardzone, odporne na ścieranie, GJN	

* Grupa materiałowa wg MAPAL

** Jeśli składniki stopu Cr, Mo, Ni, V, W wynoszą łącznie > 8 %, wybierz następną w kolejności grupę materiałową

	ø < 5 [mm]		ø < 5 - 8 [mm]		ø < 8 - 12 [mm]		ø < 12 - 16 [mm]		ø < 16 - 20 [mm]		ø < 20 - 25 [mm]		ø < 25 - 31 [mm]	
	v _c [m/min]	f [mm]	v _c [m/min]	f [mm]	v _c [m/min]	f [mm]	v _c [m/min]	f [mm]	v _c [m/min]	f [mm]	v _c [m/min]	f [mm]	v _c [m/min]	f [mm]
	60	0,06	60	0,08	60	0,10	60	0,12	60	0,14	60	0,18	60	0,22
	50	0,04	50	0,06	50	0,08	50	0,10	50	0,12	50	0,14	50	0,18
	50	0,04	50	0,06	50	0,08	50	0,10	50	0,12	50	0,14	50	0,18
	40	0,03	40	0,04	40	0,05	40	0,06	40	0,08	40	0,10	40	0,12
	50	0,04	50	0,06	50	0,08	50	0,10	50	0,12	50	0,14	50	0,18
	40	0,03	40	0,04	40	0,05	40	0,06	40	0,08	40	0,10	40	0,12
	30	0,04	30	0,05	30	0,06	30	0,07	30	0,08	30	0,09	30	0,12
	50	0,04	50	0,06	50	0,08	50	0,10	50	0,12	50	0,14	50	0,18
	30	0,04	30	0,05	30	0,06	30	0,07	30	0,08	30	0,09	30	0,12
	30	0,04	30	0,05	30	0,06	30	0,07	30	0,08	30	0,09	30	0,12
	25	0,04	25	0,05	25	0,06	25	0,07	25	0,08	25	0,09	25	0,12
	30	0,04	30	0,05	30	0,06	30	0,07	30	0,08	30	0,09	30	0,12
	25	0,04	25	0,05	25	0,06	25	0,07	25	0,08	25	0,09	25	0,12
	50	0,06	50	0,10	50	0,12	50	0,14	50	0,18	50	0,20	50	0,25
	45	0,06	45	0,10	45	0,12	45	0,14	45	0,18	45	0,20	45	0,25
	45	0,06	45	0,10	45	0,12	45	0,14	45	0,18	45	0,20	45	0,25
	45	0,06	45	0,10	45	0,12	45	0,14	45	0,18	45	0,20	45	0,25
	35	0,06	35	0,10	35	0,12	35	0,14	35	0,18	35	0,20	35	0,25
	35	0,06	35	0,10	35	0,12	35	0,14	35	0,18	35	0,20	35	0,25
	80	0,08	80	0,10	80	0,12	80	0,14	80	0,18	80	0,22	80	0,26
	80	0,08	80	0,10	80	0,12	80	0,14	80	0,18	80	0,22	80	0,26
	60	0,08	60	0,10	60	0,12	60	0,14	60	0,18	60	0,22	60	0,26
	60	0,08	60	0,10	60	0,12	60	0,14	60	0,18	60	0,22	60	0,26
	70	0,10	70	0,12	70	0,14	70	0,18	70	0,20	70	0,24	70	0,30
	70	0,10	70	0,12	70	0,14	70	0,18	70	0,20	70	0,24	70	0,30
	70	0,10	70	0,12	70	0,14	70	0,18	70	0,20	70	0,24	70	0,30
	25	0,06	25	0,10	25	0,12	25	0,14	25	0,18	25	0,20	25	0,25
	25	0,06	25	0,10	25	0,12	25	0,14	25	0,18	25	0,20	25	0,25
	70	0,10	70	0,12	70	0,14	70	0,18	70	0,20	70	0,24	70	0,30
	70	0,10	70	0,12	70	0,14	70	0,18	70	0,20	70	0,24	70	0,30
	70	0,10	70	0,12	70	0,14	70	0,18	70	0,20	70	0,24	70	0,30
	25	0,06	25	0,10	25	0,12	25	0,14	25	0,18	25	0,20	25	0,25
	25	0,06	25	0,10	25	0,12	25	0,14	25	0,18	25	0,20	25	0,25
	25	0,06	25	0,10	25	0,12	25	0,14	25	0,18	25	0,20	25	0,25
	25	0,06	25	0,10	25	0,12	25	0,14	25	0,18	25	0,20	25	0,25
	25	0,06	25	0,10	25	0,12	25	0,14	25	0,18	25	0,20	25	0,25
	25	0,06	25	0,10	25	0,12	25	0,14	25	0,18	25	0,20	25	0,25
	25	0,06	25	0,10	25	0,12	25	0,14	25	0,18	25	0,20	25	0,25
	25	0,06	25	0,10	25	0,12	25	0,14	25	0,18	25	0,20	25	0,25
	25	0,06	25	0,10	25	0,12	25	0,14	25	0,18	25	0,20	25	0,25
	25	0,06	25	0,10	25	0,12	25	0,14	25	0,18	25	0,20	25	0,25
	25	0,06	25	0,10	25	0,12	25	0,14	25	0,18	25	0,20	25	0,25
	15	0,04	15	0,05	15	0,06	15	0,07	15	0,08	15	0,09	15	0,12
	15	0,04	15	0,05	15	0,06	15	0,07	15	0,08	15	0,09	15	0,12
	15	0,04	15	0,05	15	0,06	15	0,07	15	0,08	15	0,09	15	0,12
	15	0,04	15	0,05	15	0,06	15	0,07	15	0,08	15	0,09	15	0,12
	15	0,04	15	0,05	15	0,06	15	0,07	15	0,08	15	0,09	15	0,12
	15	0,04	15	0,05	15	0,06	15	0,07	15	0,08	15	0,09	15	0,12
	12	0,04	12	0,05	12	0,06	12	0,08	12	0,08	12	0,10		
	12	0,04	12	0,05	12	0,06	12	0,08	12	0,08	12	0,10		
	8	0,04	8	0,05	8	0,06	8	0,08	8	0,08	8	0,10		
	8	0,04	8	0,05	8	0,06	8	0,08	8	0,08	8	0,10		
	12	0,04	12	0,05	12	0,06	12	0,08	12	0,08	12	0,10		

Podane parametry skrawania to wartości orientacyjne.

Optymalne wartości dla danego przypadku obróbki należy ustalić w ramach próby lub podczas obróbki.

NAWIERCANIE I TOCZENIE

Oprawki narzędziowe oferują maksymalną elastyczność w zakresie opracowania indywidualnych rozwiązań narzędziowych. Program ModulBore jako modułowe rozwiązanie do nawiercania i rozwiercania precyzyjnego.

Płytki skrawające promieniowe ustawione pod kątem dodatnim, przeznaczone do nawiercania i toczenia. Płytki skrawające styczne do najbardziej zaawansowanych wymagań w obszarze nawiercania.



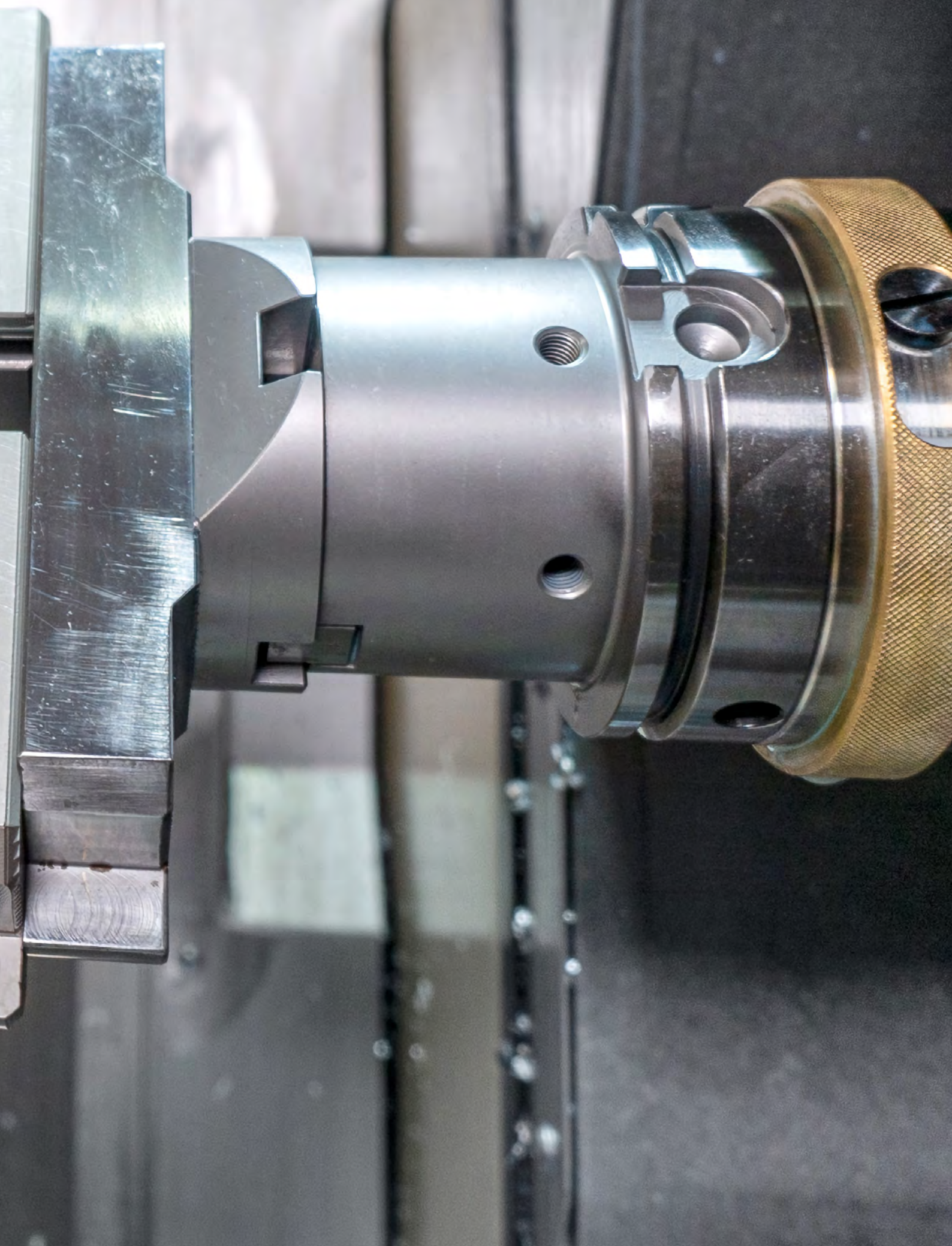

PRZEGLĄD PRODUKTÓW

Nawiercanie i toczenie

Nawiertaki MAPAL, które umożliwiają wykonanie etapu obróbki między wierceniem w pełnym materiale a obróbką precyzyjną, stanowią optymalne połączenie solidności – przy uwzględnieniu występujących sił skrawania – z wysoką ekonomicznością. Dzięki innowacyjnej technologii i najwyższej precyzji MAPAL oferuje kompleksowy program narzędzi specjalnych z płytkami skrawającymi i ostrzami lutowanymi PCD. Właściwe podejście do całego procesu obróbki i rozpoczęcia produkcji pozwala na osiągnięcie rzeczywistych postępów.

Oferowany przez MAPAL program standardowy ModulBore to uniwersalny system do obróbki wstępnej i wykończeniowej otworów w zakresie średnicy od 6 do 1000 mm. Dzięki

prostej regulacji oprawki narzędziowe dają wiele możliwości w różnych zastosowaniach. Program standardowy jest kompatybilny ze wszystkimi typowymi płytkami skrawającymi ISO i obejmuje znaczną część wariantów montażu.

Asortyment płytek skrawających w wykonaniu specjalnym, promieniowych i stycznych spełnia wszystkie wymagania dotyczące materiałów skrawających i powłok, jak również odpowiednich geometrii ostrzy i dokładności. Wybrane płytki skrawające z ostrzami z węgla spiekane i PCD są również dostępne do zastosowań w obszarze toczenia.



Rozwiązania specjalne



Nawiercanie narzędziami z PCD

- Indywidualne rozwiązania narzędziowe do wymagających zadań obróbczych
- Najwyższa jakość obróbki pod względem wymiarów, powierzchni i kształtu
- Realizacja złożonych geometrii skrawania
- Narzędzia spiralne do obróbki filigranowych lub niestabilnych elementów i zespołów
- Tolerancje produkcyjne średnicy narzędzia $\leq 3 \mu\text{m}$
- Wykonanie wielostopniowe gwarantuje współosiowość w przypadku otworów stopniowanych
- Nawiertaki jako narzędzia typu kombi umożliwiają zredukowanie czasów nieproduktywnych
- Zoptymalizowane pod kątem użycia z minimalną ilością czynnika smarującego-chłodzącego (MMS)



Nawiercanie narzędziami z płytkami skrawającymi

- Wielostopniowa konstrukcja zmniejsza ilość potrzebnych narzędzi i skraca czas obróbki
- Wyższa wydajność dzięki zastosowaniu stycznej zabudowy płytki
- Listwy prowadzące zapewniają bardzo wysoką dokładność pozycji narzędzia
- Sprężyste listwy prowadzące dla stabilnej obróbki dużych głębokości wiercenia
- Narzędzia hybrydowe łączą różne systemy narzędziowe
- Tłumiki drgań zapewniają wyższą jakość obróbki i wytrzymałość narzędzia w niestabilnych sytuacjach obróbkowych lub przy dużych wycięgach



Płytki skrawające w wykonaniu specjalnym

- Realizacja złożonych geometrii i konturów dla prawie wszystkich zastosowań
- Ostrza kształtowe do obróbki złożonych konturów z dużą dokładnością kształtu
- Nowoczesne urządzenia produkcyjne gwarantują najwyższą precyzję i elastyczność płytek specjalnych MAPAL
- Wydajne materiały skrawające do obróbki dowolnych materiałów obrabianych
- Dostępne również płytki skrawające z ostrzami z PCD i PcBN



Program standardowy



ModulBore

- Zakres średnicy od 6 do 1000 mm
- Wysoka elastyczność dzięki modułowej konstrukcji
- Jedno narzędzie może służyć do obróbki większych zakresów średnicy
- Wewnętrzne doprowadzenie chłodziwa do optymalnego usuwania wiórów
- Dostępne w wersji z precyzyjną regulacją (ModulBore-Plus)
- Ząbkowanie powierzchni czołowej gwarantuje stabilność i wydajność systemu
- Wariant z oprawkami narzędziowymi ISO do obróbki dużych średnic



Oprawki narzędziowe

- Wysoka elastyczność dzięki szybkiej i łatwej wymianie
- Możliwość regulacji z dużym skokiem nastawczym
- Kompatybilne ze wszystkimi typowymi płytkami skrawającymi ISO
- Odpowiednie zarówno do obróbki zewnętrznej, jak i wewnętrznej
- Dostępne w różnych wariantach montażowych
- Dostępne również jako kompaktowe oprawki narzędziowe w wersji krótkiej



Płytki skrawające

- Dodatkowo ostrza promieniowe do nawiercania i toczenia
- Płytki skrawające styczne do najbardziej zaawansowanych wymagań
- Dostępne ostrza szlifowane i wytłaczane
- Materiały skrawające z powłokami PVD i CVD obejmują szeroki zakres właściwości pomiędzy odpornością na zużycie a ciągliwością
- Warianty z ostrzami PCD i PcBN do bardzo ekonomicznej obróbki aluminium i żeliwa

ROZWIĄZANIA SPECJALNE

Nawiercanie narzędziami z PCD

W obszarze stabilnej i ekonomicznej obróbki dużych ilości elementów z aluminium i aluminiowych odlewów ciśnieniowych pierwszym wyborem są rozwiązania specjalne z ostrzami PCD. Dzięki zastosowaniu nowoczesnych układów sterowania CNC i technologii laserowej obecnie możliwe jest stabilne wykonanie niemal każdej geometrii skrawania – i to z tolerancją wykonania $\leq 3 \mu\text{m}$ dla średnic narzędzi.

Szczególnie korzystne jest połączenie kilku zadań obróbczych w jednym narzędziu. Oszczędność narzędzi i redukcja czasów nieproduktywnych podnosi ekonomiczność produkcji.

Do wykonywania otworów stopniowanych, w których konieczna jest obróbka wszystkich faz i promieni, służą nawiertaki wielostopniowe PCD. Takie rozwiązanie gwarantuje współosiowość poszczególnych stopni. Narzędzie wiertarskie umożliwia również ekonomiczną obróbkę wcięć osiowych lub pogłębianie czółowe powierzchni styku. Wymogi dotyczące płaskości lub dokładności kątowej można spełnić wielokrotnie łatwiej niż w przypadku konwencjonalnych ruchów obrotowych lub kolistych, ponieważ na obrabiany przedmiot nie działają siły promieniowe.

Narzędzia PCD MAPAL z rowkami spiralnymi mają istotne zalety w stosunku do narzędzi z rowkami prostymi. Narzędzia mogą być elastycznie zaprojektowane pod kątem danego procesu, na przykład smarowania minimalną ilością środka smarująco-chłodzącego. Wykonania HSK i regulowane systemy modułowe zapewniają optymalne wyniki.

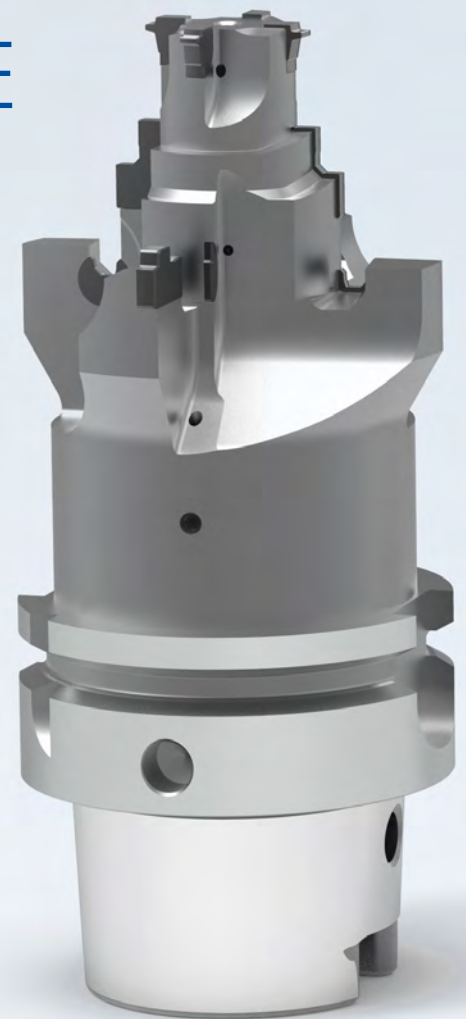

Rozwiązania specjalne



Diament polikrystaliczny – PCD

- PCD jako materiał skrawający do obróbki aluminium, metali kolorowych, CFK i innych nowoczesnych materiałów obrabianych
- Wytwarzany syntetycznie z wyselekcjonowanych cząstek diamentu
- Spiekane w temperaturze ok. 1500°C i pod ciśnieniem ok. 60 kbar
- Wyjątkowo twarda i odporna na zużycie struktura
- Wykorzystanie różnych podłoży pozwala zawsze na dobór odpowiedniego materiału skrawającego do danego przypadku obróbki



Centrum kompetencyjne w zakresie PCD

- Centrum kompetencyjne MAPAL w zakresie narzędzi PCD w Pforzheim
- Wiodący światowy zakład projektowania i produkcji narzędzi PCD
- Wysokie standardy jakości i doskonałe kwalifikacje pracowników gwarantują najwyższej klasy rezultaty produkcji
- Wykorzystanie najnowszych technologii produkcji
- Zastosowanie technologii laserowej

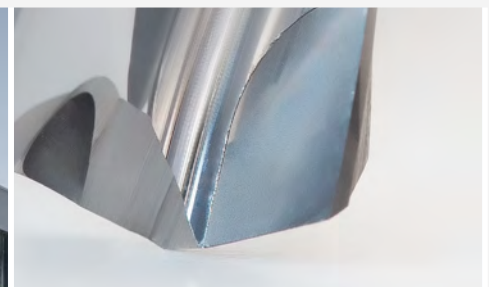

Najwyższa precyzja

- Ostrza PCD szlifowane z dokładnością do μm dla najwyższej precyzji
- Tolerancje produkcyjne średnicy narzędzia $\leq 3 \mu\text{m}$
- Najwyższa jakość obróbki pod względem wymiarów, powierzchni i kształtu
- Utwardzane laserowo łamacze wiórów, rozdzielacze wiórów i rowki formujące wiór umożliwiają optymalne usuwanie wiórów i zapobiegają ich gromadzeniu się
- Modułowa konstrukcja zapewniająca niską wartość bicia
- Precyzyjne i bezpieczne ustawianie bicia dzięki możliwościom regulacji osiowej i promieniowej

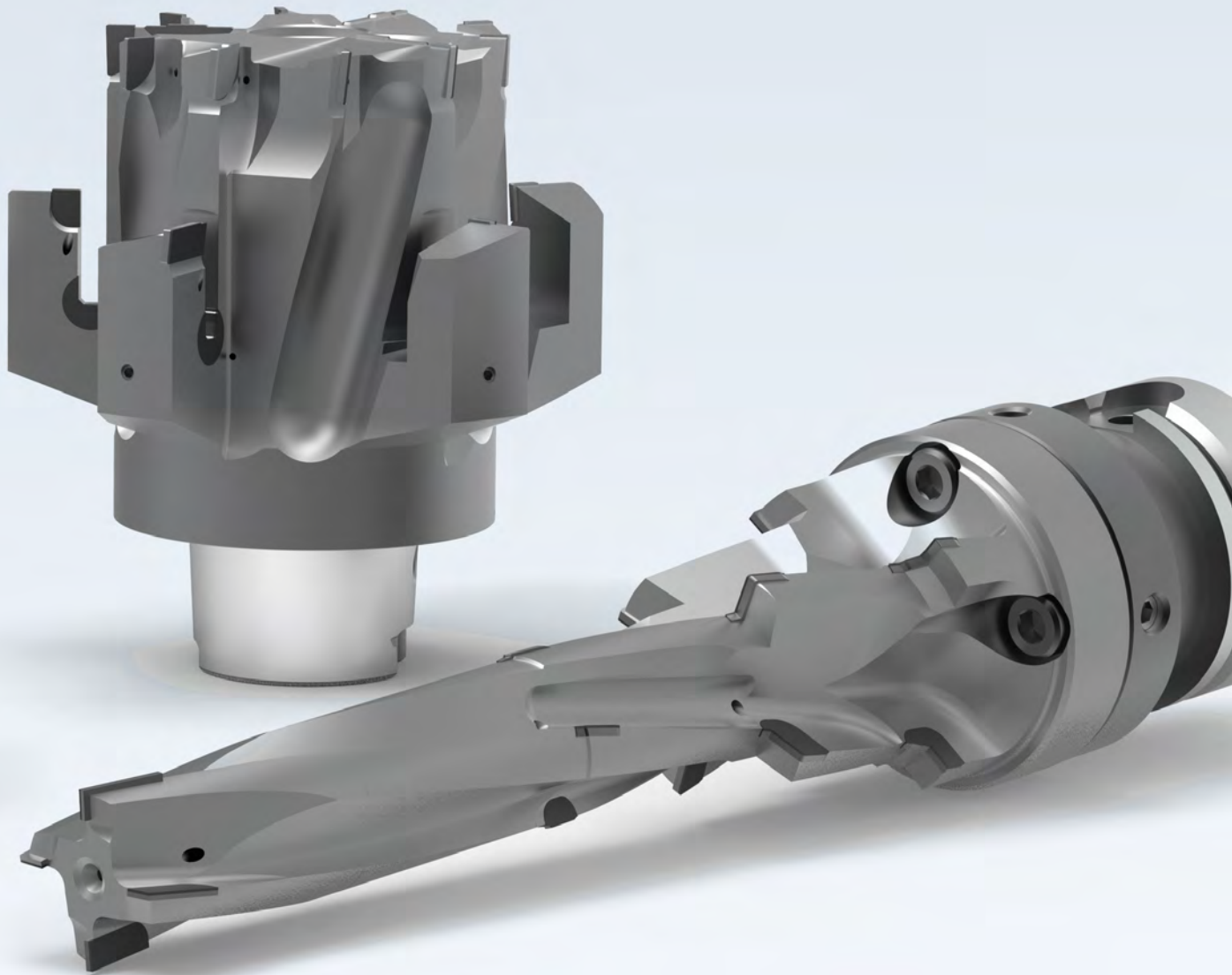

Złożone geometrie

- Obróbka laserowa umożliwia precyzyjne wykonanie wysoce złożonych geometrii ostrzy, jak również realizację nietypowych kątów natarcia i kątów spirali
- Zalety nawiertaków PCD z rowkami spiralnymi w porównaniu z odpowiednikami z rowkami prostymi:
 - Dobre własności pod względem prowadzenia narzędzia i bardzo wysoka jakość obróbki
 - Wysokie dodatnie kąty natarcia zmniejszają niezbędną siłę skrawania
 - Idealne do obróbki filigranowych lub niestabilnych elementów i zespołów
 - Lepšie odprowadzanie wiórów dzięki wykonaniu rowków

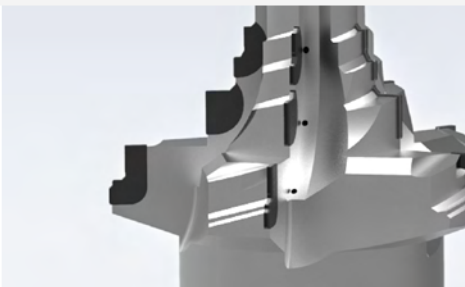

Innowacyjne rozwiązania

- Opracowanie stabilnych rozwiązań opartych na efektywnych strategiach obróbki, takich jak smarowanie minimalną ilością czynnika smarująco-chłodzącego (MMS)
- Narzędzia kombi redukują liczbę kroków procesu i skracają czasy nieproduktywne
- Wielostopniowe nawiertaki PCD gwarantują współosiowość otworów stopniowanych
- Precyzyjnie osadzone segmenty PCD
- Dokładnie dopasowane do danej geometrii stopnia



Regeneracja

- Regeneracja znacznie wydłuża żywotność nawiertaków PCD
- Oszczędność kosztów zakupu nowych narzędzi
- Narzędzia gotowe do natychmiastowego użytku
- Bezproblemowe uzyskanie deklarowanej trwałości narzędzi
- Odbiór i dostawa bezpośrednio od/do klienta przez firmę kurierską
- Ustandaryzowany proces zapewniający nieskomplikowaną i szybką realizację zlecenia w ciągu kilku dni

ROZWIĄZANIA SPECJALNE

Nawiercanie narzędziami z PCD (1/2)

Przykłady zastosowań rozwiązań specjalnych z PCD

- 1 Nawiertak z lutowanymi płytkami skrawającymi PCD i wymiennymi standardowymi płytkami skrawającymi z możliwością regulacji, do wykonywania otworów w tolerancji IT6 i o zdefiniowanej chropowatości
- 2 Narzędzie do wiercenia stopniowego z regulowanym i wymiennym systemem obróbki wstecznej, do obróbki obudowy mechanizmu różnicowego wykonanej z aluminium
- 3 Nawiertak kombi do obróbki pompy olejowej, z wymiennym narzędziem wtykowym z węgla spiekane
- 4 Wielostopniowy nawiertak do obróbki obudowy kierownicy/rury kierownicy wykonanej z AISi9Cu3. Dzięki korpusowi z tytanu narzędzie waży tylko 5,5 kg mimo bardzo dużych wymiarów
- 5 Nawiertak w konstrukcji lekkiej do obróbki płyty podstawy sprężarki wykonanej z AISi9Cu3. Dzięki niewielkiemu ciężarowi narzędzia możliwe jest uzyskanie wysokich parametrów skrawania, a także małe obciążenie wrzeciona
- 6 Spiralny nawiertak stopniowy do obróbki obudowy kierownicy wykonanej z AISi9Cu3, z regulowanym złączem modułowym. Dzięki spiralnej konstrukcji – bardzo miękkie skrawanie i mechaniczne odprowadzanie wiórów
- 7 Nawiertak stopniowy do obróbki otworu łożyskowego ze zintegrowaną regulacją precyzyjną do pilotowania otworu wałka rozrządu w pokrywie głowicy cylindrowej z AISi9Cu3Fe, do procesu ze smarowaniem minimalną ilością czynnika smarująco-chłodzącego

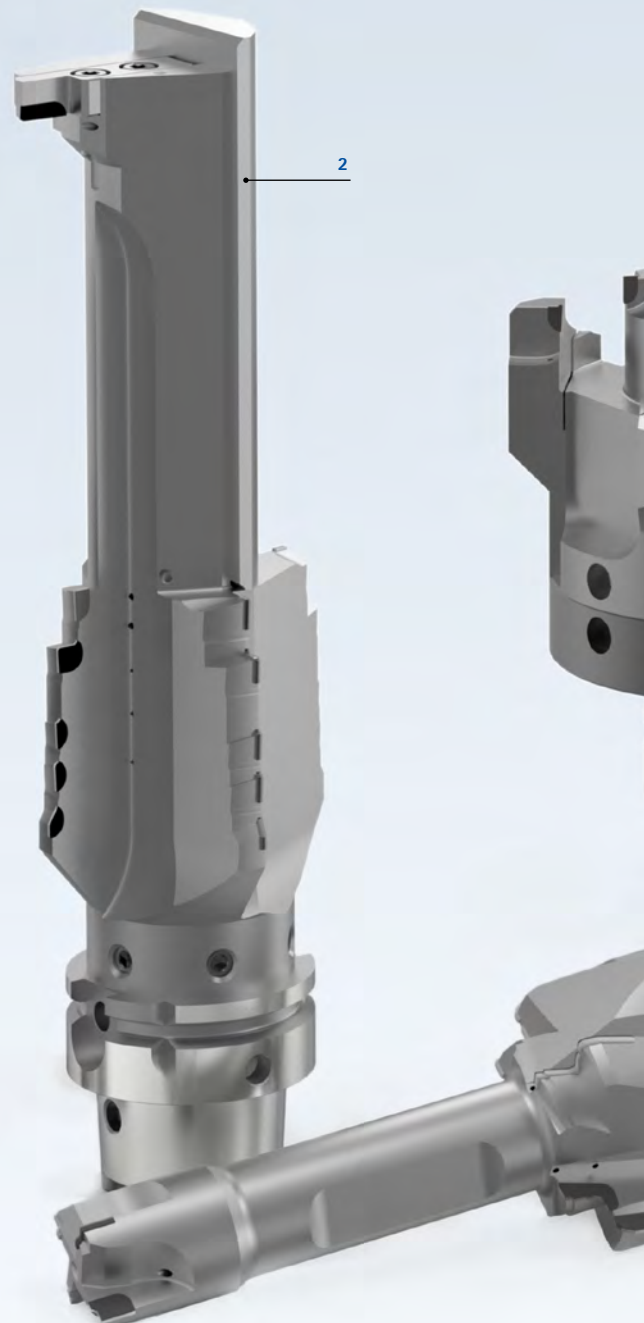
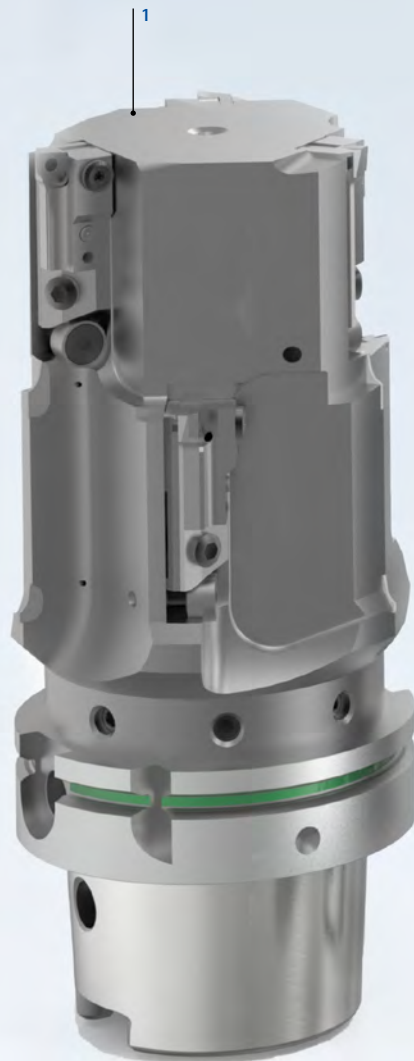

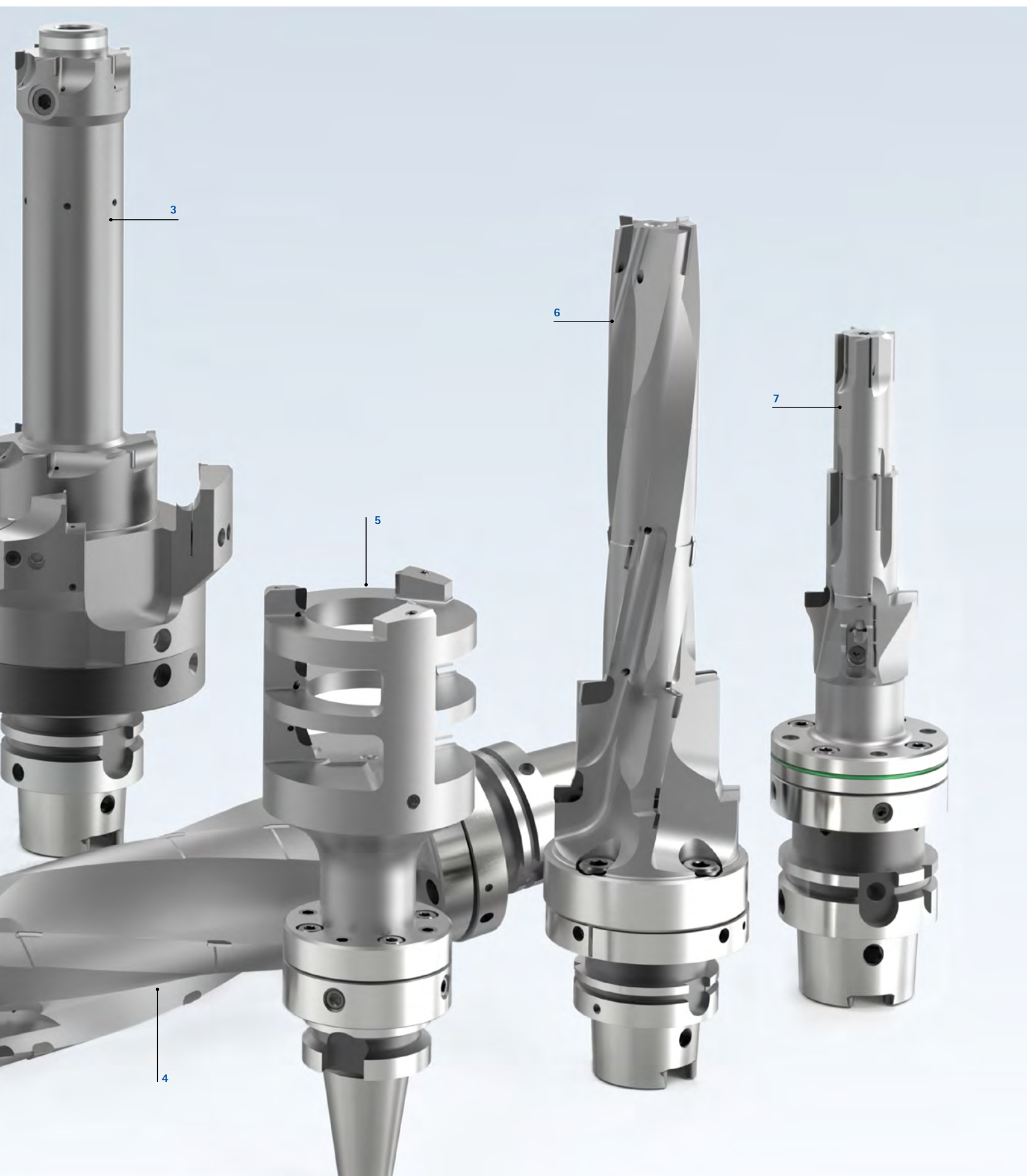

ROZWIĄZANIA SPECJALNE

Nawiercanie narzędziami z PCD (2/2)

Przykłady zastosowań rozwiązań specjalnych z PCD

- 1 Narzędzie wiertarsko-frezarskie do obróbki zwrotnicy („steering knuckle”) wykonanej z aluminium. Osadzone krawędzie skrawające zapewniają powierzchnie bez odprysków przy zachowaniu wszystkich tolerancji zarówno w zakresie wiercenia, jak i frezowania
- 2 Narzędzie typu „dzwonek” z lutowanymi ostrzami PCD w konstrukcji lekkiej, do obróbki zewnętrznej przyłączy węży. Struktura plastra miodu wewnątrz narzędzia znacznie zmniejsza jego ciężar, co umożliwia uzyskanie wyższych parametrów skrawania. Dodatkowo struktura ta ma działanie amortyzujące, co pozytywnie wpływa na wytrzymałość narzędzia
- 3 Narzędzie wiertarsko-frezarskie kombi z ostrzami PCD i płytkami skrawającymi z węgla spiekanego do obróbki ramy tylnej wykonanej z AlSiMg0.3. Najbardziej obciążone ostrza zostały zaprojektowane w sposób umożliwiający wymianę
- 4 Spiralne trójstrzowe narzędzie do wiercenia stopniowego w pełnym materiale, do obróbki otworu na śrubę w feldze aluminiowej
- 5 Rozwiązanie narzędziowe typu „wszystko w jednym” ze zintegrowanym tłumikiem drgań, do obróbki siłownika zwrotnego układu kierowniczego
- 6 Frez okrągły o liczbie ostrzy 1+1+1 do obróbki obudowy termicznej wykonanej z AL380
- 7 Nawiertak wielostopniowy PCD do obróbki typu „wszystko w jednym” obudowy silnika elektrycznego wykonanej z AlSi9Cu3Fe w wersji wydrążonej, do pracy na obrabiarkach o wysokiej stabilności i mocy
- 8 Nawiertak stopniowy do wewnętrznej i zewnętrznej obróbki obudowy przekładni wykonanej z AlSi9Cu3Mg

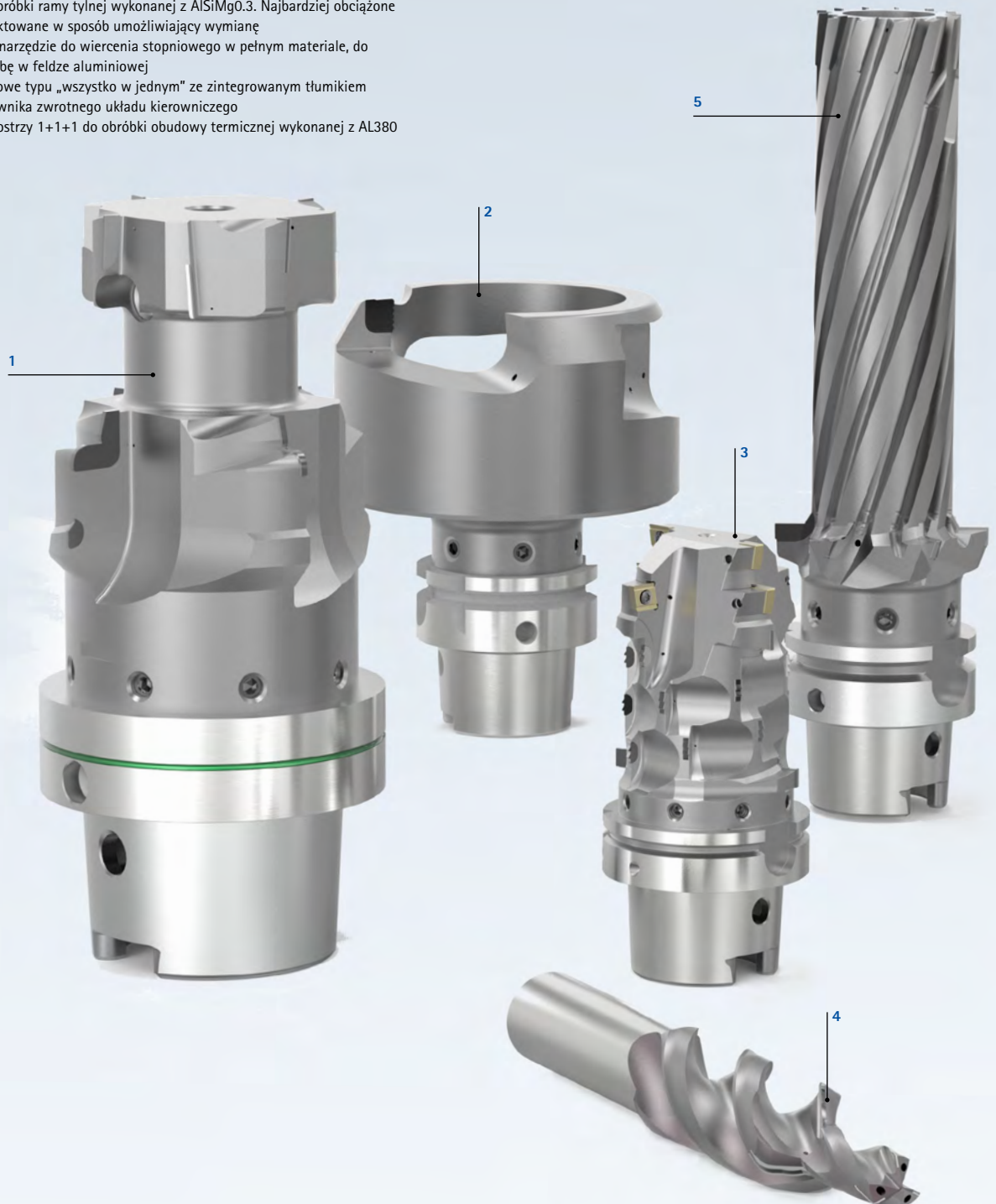

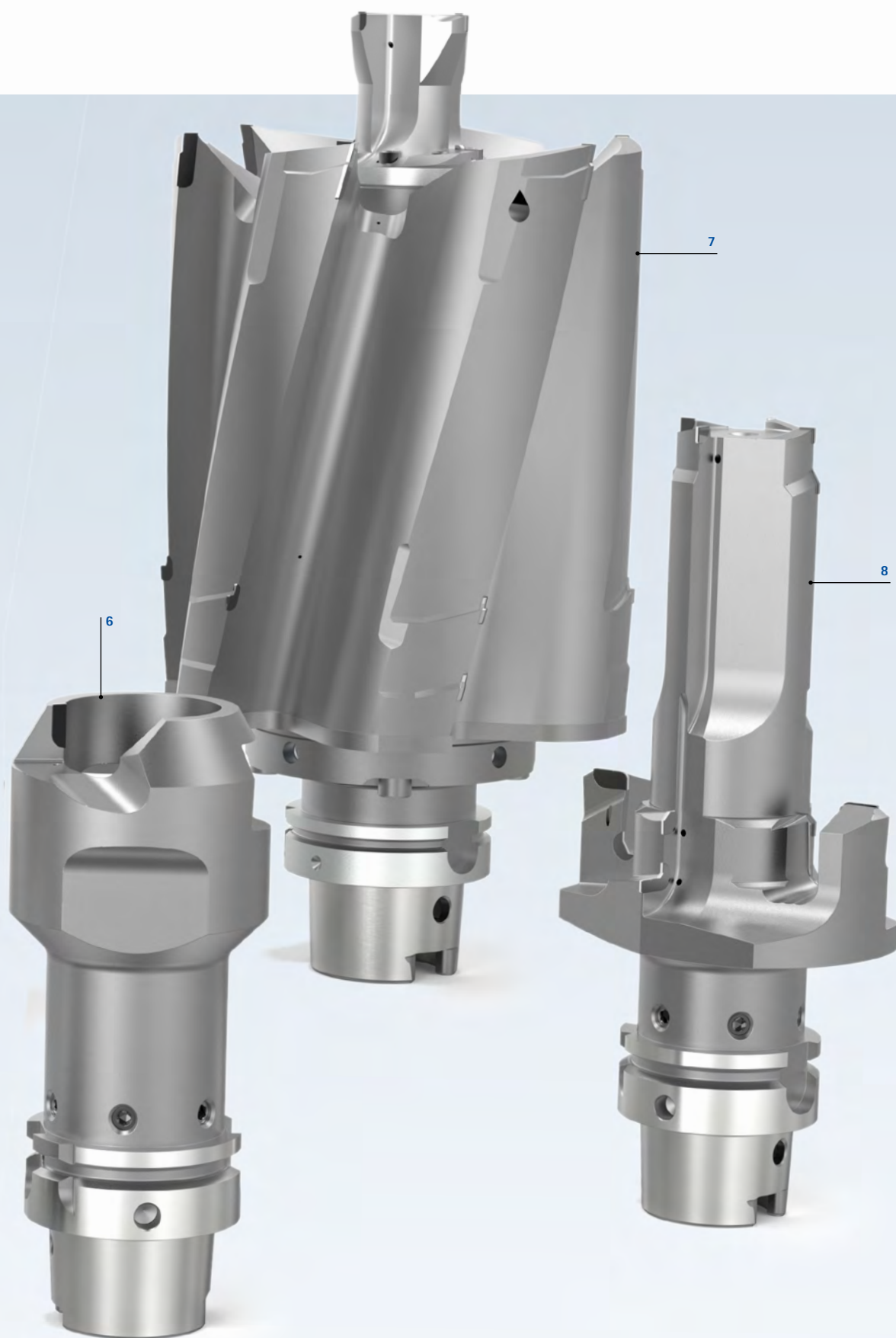

ROZWIĄZANIA SPECJALNE

Nawiercanie narzędziami z płytkami skrawającymi

Podczas opracowywania nowych procesów obróbki, jak również optymalizacji procesów istniejących, główny nacisk kładzie się na uwzględnienie czasu obróbki i kosztu jednostkowego części (CPP). Inteligentne, wielostopniowe i wieloosłzowe narzędzia kombi lub kompletne narzędzia do obróbki z płytkami skrawającymi pozwalają na znaczne skrócenie zarówno czasu produkcji, jak i czasów nieprodukcyjnych. Z myślą o opracowaniu rozwiązań optymalnych dla klienta łączy się różne systemy obróbki, tworząc tzw. narzędzia hybrydowe.

Narzędzia z płytkami skrawającymi firmy MAPAL spełniają wymagania dotyczące zarówno stabilności procesu, jak i łatwej obsługi – dzięki inteligentnym i precyzyjnym rozwiązaniom w zakresie adapterów oraz bezpiecznym i szybkim opcjom mocowania płytek skrawających.

Niezawodne funkcjonowanie narzędzi z płytkami skrawającymi jest zagwarantowane przez zastosowanie najnowocześniejszych metod projektowania, które pozwalają na uwzględnienie ewentualnych kolizji lub zidentyfikowanie kolidujących konturów już na etapie projektowania. Wytwarzanie na najnowocześniejszych urządzeniach produkcyjnych gwarantuje najwyższą precyzję wykonania narzędzi.

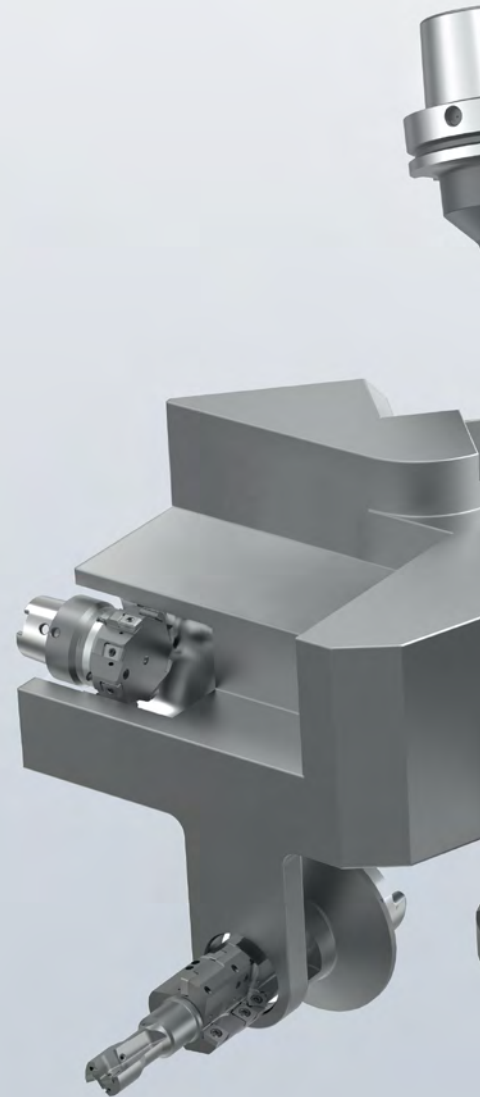

Rozwiązania specjalne



Rozwiązania technologiczne

- Wydajne kompletne narzędzia obróbcze skracają zarówno czas produkcji, jaki i czas nieprodukcyjny
- Zoptymalizowane procesy skracają czas obróbki nawet o 60%
- Skrócone czasy cykli
- Niższe zużycie energii
- Wyższa opłacalność

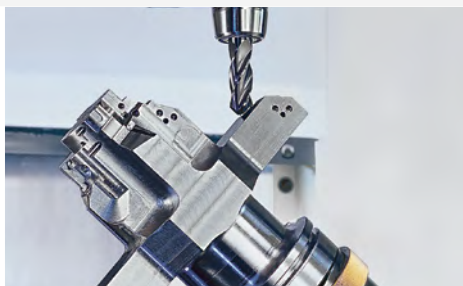

Konstrukcja i wytwarzanie

- Rozwój i projektowanie złożonych narzędzi stycznych przy użyciu najnowocześniejszego projektowania 3D i testów wspomaganym komputerowo
- Precyzyjnie zaprojektowane gniazda płytek i przestrzenie na wióry
- Produkcja z wykorzystaniem precyzyjnych, wydajnych 5-osiowych centrów obróbczych
- Proces nadzorowany i kontrolowany przez doświadczonych pracowników
- Zachowanie ścisłych tolerancji produkcyjnych
- Faktyczna obróbka za pomocą kilku krawędzi skrawających i wysoka wydajność narzędzi



Modułowa konstrukcja

- Modułowa konstrukcja narzędzi kombi z płytkami skrawającymi
- Obróbka całych rodzin komponentów przy użyciu zaledwie kilku narzędzi
- W przypadku zużycia wystarczy wymienić tylko tę część narzędzia, która się zużyła
- Z punktu widzenia technologii produkcji, szczególnie złożone narzędzia mogą być projektowane przez zastosowanie złączy, na przykład wysoce precyzyjnego złącza HSK-C
- Integracja kilku etapów obróbki w jednym narzędziu
- Zwiększenie produktywności

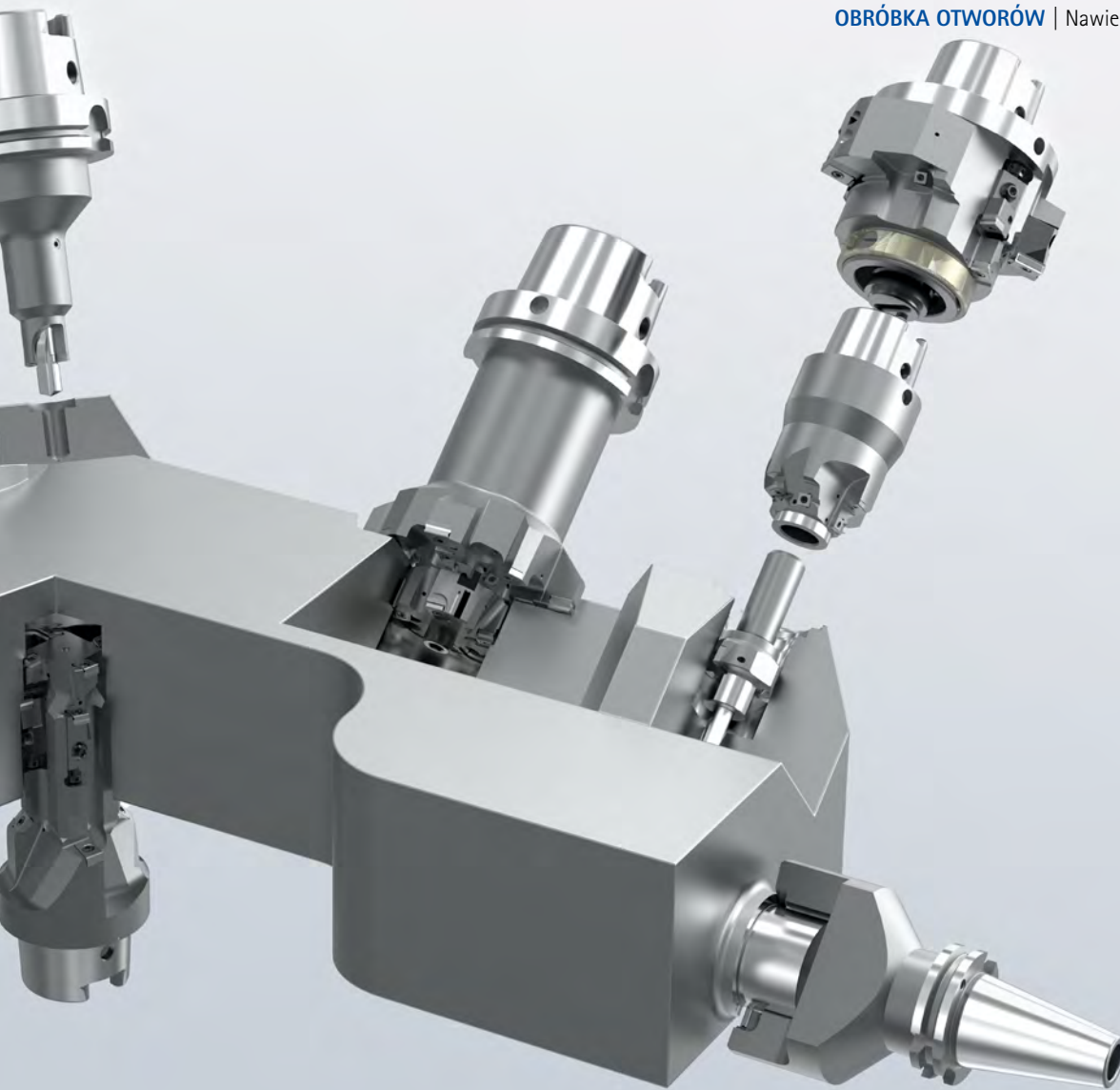

Styczna zabudowa płytki

- Styczna zabudowa płytki dla wysokiej wydajności nawiertaków z płytkami skrawającymi
- W porównaniu z użyciem płytek skrawających mocowanych promieniowo możliwe jest zastosowanie większej liczby ostrzy przy takim samym poborze mocy
- Wyższe parametry robocze i większy wolumen skrawania
- Spokojna praca
- Doskonała wytrzymałość narzędzi i bardzo wysoka jakość komponentów

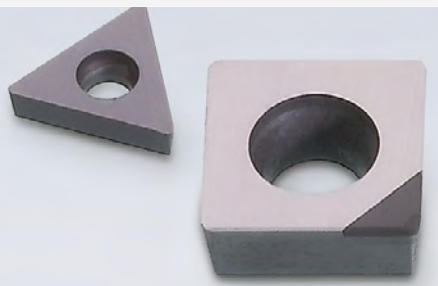

Ostrza

- Szeroki wybór geometrii i materiałów skrawających
- Odpowiednie ostrze do każdego zastosowania
- Różne kształty i wielkości
- Dostępne wszystkie materiały skrawające, takie jak węgiel spiekany, ceramika i płytki skrawające z ostrzami z PCD lub PcBN
- Wysoka ekonomiczność i efektywność wykorzystania zasobów
- Optymalne wykorzystanie materiału skrawającego dzięki nawet ośmiu krawędziom skrawającym

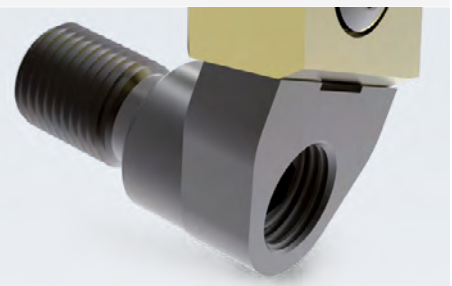

Dokładna regulacja

- Specjalnie opracowany system regulacji umożliwiający bardzo precyzyjne ustawienie ostrzy
- Stabilne podparcie dzięki klinowi regulacyjnemu całkowicie osadzonemu w korpusie narzędzia
- Znaczna część powierzchni ostrza leży na klinie regulacyjnym, który jest wykonany ze spadkiem i może być przemieszczany za pomocą śruby z gwintem lewo-prawym
- Śruba z gwintem lewo-prawym zapewnia pośrednią, bardzo precyzyjną i łatwą możliwość regulacji

ROZWIĄZANIA SPECJALNE

Nawiercanie narzędziami z płytkami skrawającymi (1/2)

Przykłady zastosowań rozwiązań specjalnych z płytkami skrawającymi

- 1 Obróbka otworu wirnika w obudowie sprężarki wykonanej z GJL z tłumikiem drgań po stronie czołowej
- 2 Narzędzie z szynami prowadzącymi zapewniającymi optymalne podparcie przy obróbce przelotu wrzeciona maszyny ze stołem obrotowym o długości ponad 1000 mm
- 3 Narzędzie kombi z płytkami skrawającymi i wiertłem wtykowym z węgla spiekane go do mocowania uchwytów hamulcowych i do wielostopniowej obróbki wspornika koła z GJS
- 4 Konstrukcja styczna umożliwia całkowite zagłębienie konturu kształtu w otworze wirnika turbiny w turbosprężarce wykonanej z materiałów obrabianych odpornych na wysokie temperatury, przy minimalnej ilości czynnika smarującego-chłodzącego
- 5 Narzędzie specjalne do obróbki zgrubnej i pośredniej łożysk wychylnych, wraz z łamaniem krawędzi i frezowaniem wgłębnym oraz dodatkowym wiertłem wtykowym
- 6 Ultralekkie narzędzie kombi z elementami korpusu wykonanymi z CFK; promieniowe i styczne płytki skrawające do obróbki układu głównego w obudowie przekładni wykonanej z aluminium
- 7 Narzędzie kombi do wielostopniowej obróbki przekładni do dużych obciążeń z GJL



Tłumiki drgań umożliwiają znacznie lepsze wykończenie powierzchni podczas obróbki. Konstrukcja jest indywidualnie dopasowywana do danych zadań obróbczych.

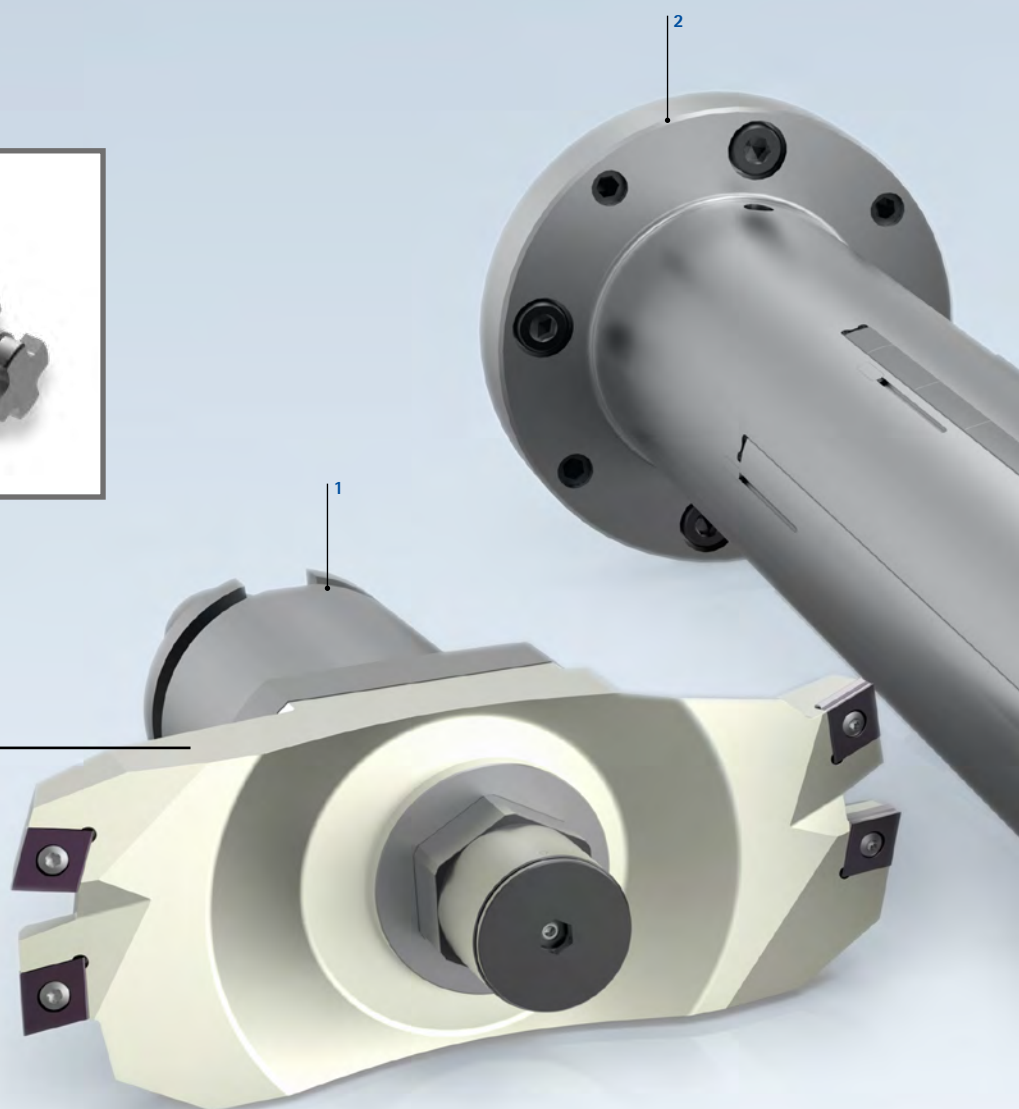

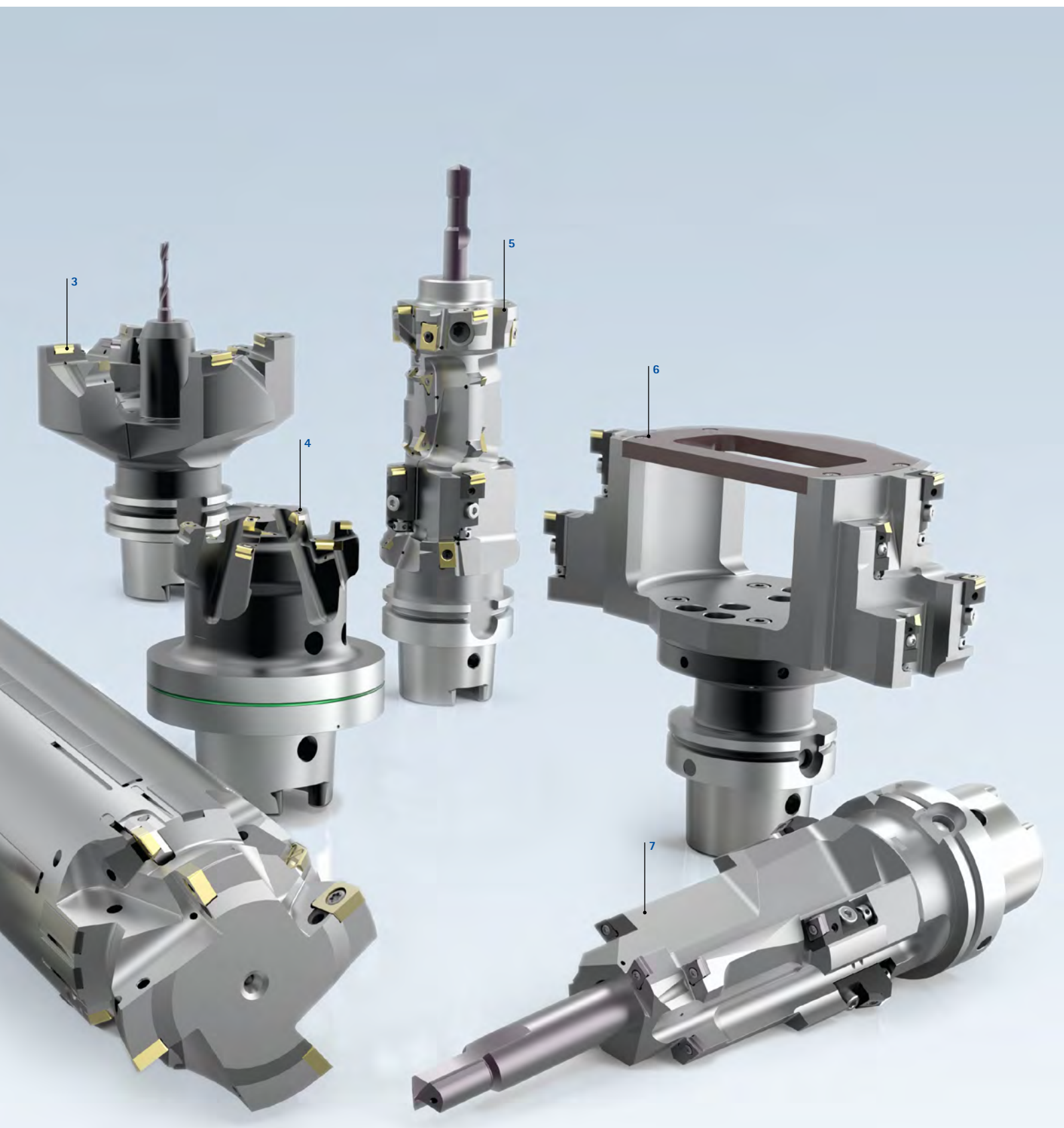

ROZWIĄZANIA SPECJALNE

Nawiercanie narzędziami z płytkami skrawającymi (2/2)

Przykłady zastosowań rozwiązań specjalnych z płytkami skrawającymi

- 1 Interpolacyjne narzędzie tokarskie z płytkami formującymi i skrawaniem ciągłym do obróbki konturu wcięcia na mocowanie obejmy V-Band do obudowy turbiny (turbo-sprężarki).
- 2 Obróbka wstępna i półwykończeniowa otworu głównego w obudowie turbiny (turbo-sprężarki). Sześć cech obróbkowych i wyrzół kontrolny są wykonywane przy użyciu tylko jednego narzędzia.
- 3 Narzędzie kombi z płytkami skrawającymi stycznymi i listwami prowadzącymi z cermetu i PCD.
- 4 Obróbka wykończeniowa obudów turbin i sprężarek przy użyciu mechatronicznego narzędzia sterującego TOOLTRONIC®.
- 5 Obróbka otworu głównego za pomocą narzędzia kombi ISO, łączącego kilka etapów obróbki: wcinanie, rozwiercanie precyzyjne i pogłębianie.





ROZWIĄZANIA SPECJALNE

Płytki skrawające w wykonaniu specjalnym

Do efektywnej obróbki złożonych konturów z dużą dokładnością kształtu często stosowane są ostrza kształtowe.

W odniesieniu do tych ostrzy MAPAL oferuje dowolne opcje pod względem kształtu, materiału skrawającego i powłoki. Nowoczesne urządzenia produkcyjne gwarantują najwyższą precyzję i elastyczność płytek skrawających MAPAL w wykonaniu specjalnym.

Wszystkie kształty płytek są również dostępne z ostrzami z PCD i PcBN. Po osadzeniu w wysoce precyzyjnych gniazdach w narzędziach MAPAL pozwalają na osiągnięcie najlepszych wyników, zarówno pod względem ekonomicznym, jak i jakościowym.



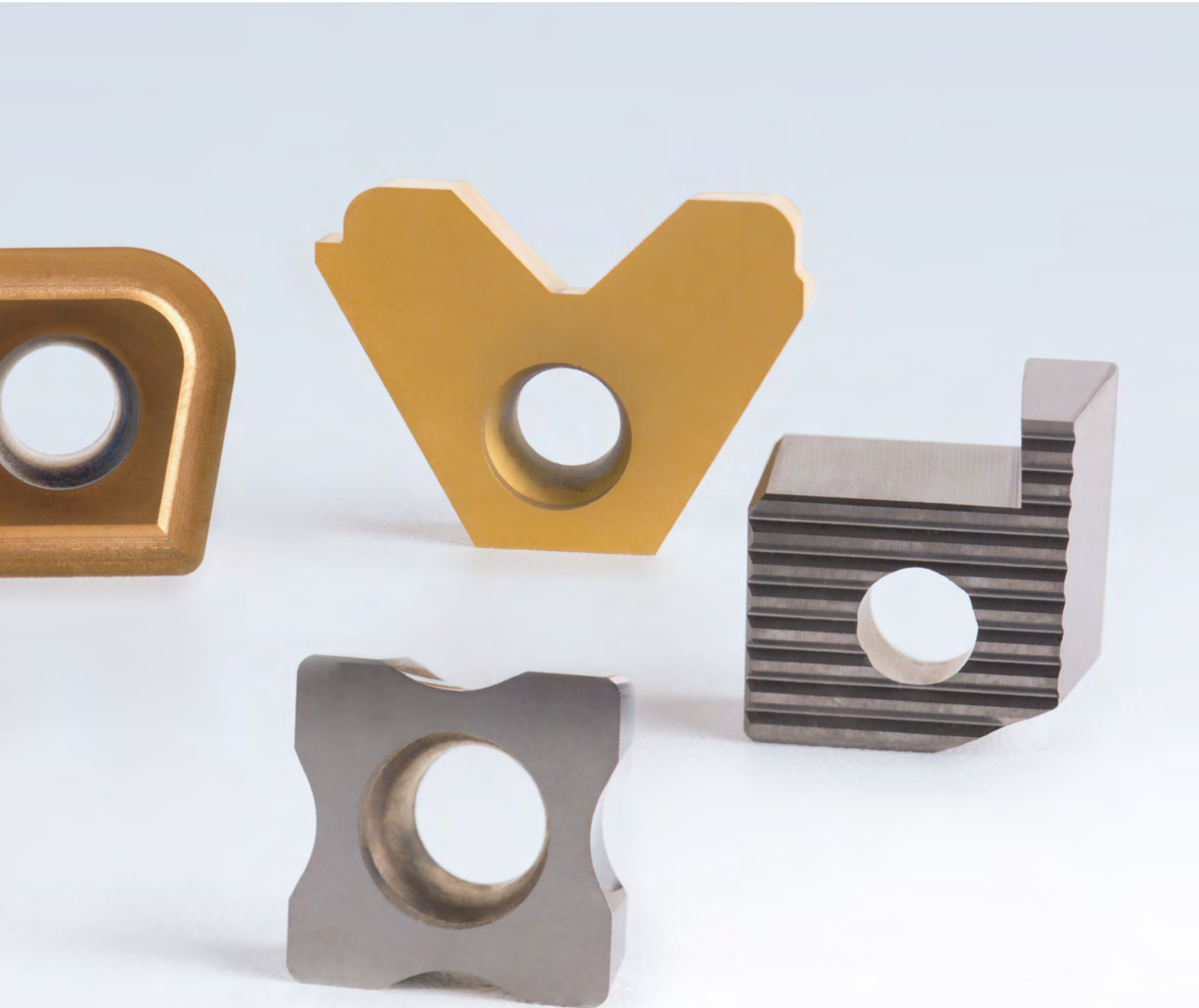

ZALETY

- Wysoka stabilność procesu w przypadku kształtów i geometrii narzuconych przez kontur
- Wylimitowanie złożonych sekwencji obróbkowych
- Wiele krawędzi skrawających do wykonywania skomplikowanych konturów





ModulBore

Duża elastyczność w operacji powiercania i rozwiercania precyzyjnego

Oferowany przez MAPAL program narzędzi do nawiercania ModulBore to uniwersalny system do obróbki wstępnej i wykończeniowej otworów w zakresie średnicy od 6 do 1000 mm.

Dzięki modułowej konstrukcji system jest bardzo elastyczny i może być skonfigurowany do danego zadania obróbczego. Do obróbki zgrubnej dostępne są nawiertaki dwuostrzowe. Dzięki ząbkowaniu powierzchni czołowej, na której osadzone są uchwyty ostrzy, narzędzia są bardzo stabilne i wydajne. Płytki skrawające o geometrii dodatniej, spiralne przestrzenie na wióry oraz wewnętrzne doprowadzenie chłodziwa gwarantują szeroki zakres zastosowań, wysokie bezpieczeństwo pracy i łatwą obsługę.

Głowice do rozwiercania precyzyjnego ModulBore są dostępne już od średnicy 6 mm. Charakteryzują się wysoką precyzją i solidną konstrukcją, są łatwe w obsłudze, a także posiadają wewnętrzne doprowadzenie chłodziwa. Regulacja głowic jest bardzo precyzyjna w obu kierunkach bez efektu „stick-slip”.

Program ModulBore jest indywidualnie dostosowywany do wymagań klienta i z tego względu nie jest dostępny z magazynu.

ModulBore

Wstęp	614
Przegląd systemu	618
ModulBore – nawiercanie	620
ModulBore – rozwiercanie precyzyjne	627
Adaptory	636

ModulBore – powiercanie

Ø 22–115 mm

Narzędzie dwuostrzowe z systemem ModulBore (MBS) w siedmiu wymiarach do uchwytów na płytki skrawające (kaset WSP).

Ø 87–202 mm

Głowice nawierające o konstrukcji mostkowej. Podzielone na pięć mostków do montażu uchwytów na płytki skrawające (kaset WSP).

Ø 200–520 mm

Głowice nawierające o konstrukcji mostkowej. Podzielone na cztery mostki do montażu sanek na typowe oprawki narzędziowe ISO.

Ø 358–1000 mm

Głowice nawierające o konstrukcji mostkowej (duży zakres wytaczania). Podzielone na osiem mostków do montażu sanek na typowe oprawki narzędziowe ISO.



* Wymagana ilość zamówienia: 2 sztuki

Narzędzia do powiercania



Narzędzia dwuostrzowe z systemem MBS

Do obróbki zgrubnej w zakresie średnicy od 22 do 115 mm dostępne są nawiertaki dwuostrzowe. Za sprawą ząbkowania powierzchni czołowej, na której osadzone są uchwyty na płytki skrawające, system jest bardzo stabilny i wydajny. Płytki skrawające o geometrii dodatniej, spiralne przestrzenie na wióry oraz wewnętrzne doprowadzenie chłodziwa gwarantują szeroki zakres zastosowań, wysokie bezpieczeństwo pracy i łatwą obsługę.

Narzędzia dwuostrzowe są dostępne zarówno w wersji modułowej, jak i monolitycznej ze złączem HSK lub SK.

* Wymagana ilość zamówienia: 2 sztuki



Głowice powierające z modułem mostkowym i oprawką narzędziową ISO

Głowice nawierające z modułem mostkowym dostępne są w zakresie od 87 do 1000 mm. Od średnicy 200 mm moduły mostkowe są wyposażone w oprawki narzędziowe ISO, które są prowadzone na sankach z użębieniem po powierzchni czołowej mostków. W celu optymalizacji wagi moduły mostkowe w zakresie średnicy od 358 do 1000 mm wykonane są z aluminium.

ModulBore – rozwiercanie precyzyjne

Ø 10–28 mm

Głowice do rozwiercania precyzyjnego z wytaczadłem

Ø 14–23 mm

Wytaczadło precyzyjne

Ø 21–115 mm

Głowica do rozwiercania precyzyjnego z systemem MBS

Ø 87–202 mm

Głowice do rozwiercania precyzyjnego o konstrukcji mostkowej. Podzielone na cztery mostki do montażu sanek na oprawki na głowice do rozwiercania precyzyjnego ModulBore.

Ø 200–520 mm

Głowice do rozwiercania precyzyjnego o konstrukcji mostkowej. Podzielone na cztery mostki do montażu sanek na oprawki na głowice do rozwiercania precyzyjnego ModulBore.

Ø 358–1000 mm

Głowice do rozwiercania precyzyjnego o konstrukcji mostkowej (duży zakres wytaczania). Podzielone na osiem mostków do montażu sanek na oprawki na głowice do rozwiercania precyzyjnego ModulBore.



Narzędzia do rozwiercania precyzyjnego



Głowica do rozwiercania precyzyjnego z wytaczadłem

Program obejmuje głowice do rozwiercania precyzyjnego ModulBore już od średnicy 6 mm. Charakteryzują się one wysoką precyzją i solidną konstrukcją, są łatwe w obsłudze, a także mają wewnętrzne doprowadzenie chłodziwa. Regulacja głowicy jest bardzo precyzyjna w obu kierunkach bez efektu „stick-slip”.

Głowice do rozwiercania precyzyjnego są dostępne zarówno w wersji modułowej, jak i monolitycznej ze złączem HSK lub SK.



Głowice do rozwiercania precyzyjnego z modułem mostkowym i oprawką na głowice do rozwiercania precyzyjnego

Począwszy od średnicy 87 mm, głowice do rozwiercania precyzyjnego są wykonane z modułem mostkowym. Na modułach mostkowych osadzone są sanki wyposażone w regulowane oprawki na głowice do rozwiercania precyzyjnego. W przypadku większych średnic narzędzia z modułami mostkowymi są dostępne w wykonaniu jednostrzowym. Sanki przeciwstawne służą do kompensacji niewyważenia. W celu optymalizacji wagi moduły mostkowe w zakresie średnicy od 358 do 1000 mm są wytwarzane z aluminium.

ModulBore-Plus – rozwiercanie precyzyjne

Narzędzia ModulBore-Plus z precyzyjną regulacją posiadają prosty i dokładny mechanizm nastawczy. Umożliwia to zdefiniowane wprowadzanie elementów bezpośrednio do maszyny za pomocą standardowego klucza TORX® bez ryzyka błędów. Wysoka precyzja i łatwa obsługa skracają czas nieproduktywny podczas rozwiercania precyzyjnego oraz podnoszą jakość i wydajność procesu.

MODULBORE-PLUS

- **Precyzyjna regulacja:**
2 μm na podziałkę w odniesieniu do średnicy
- **Błąd obrotu:**
< 2 μm

ZALETY

- Bezблędny odczyt (nie jest wymagany noniusz)
- Bez efektu „stick-slip”
- Niewielkie wymogi konserwacyjne
- Łatwy montaż
- Trwałe i wytrzymałe: trzy lata gwarancji

Wytaczadło precyzyjne

Wytaczadło precyzyjne ModulBore-Plus jest odpowiednie do wykorzystania w produkcji seryjnej i wielkoseryjnej oraz zapewnia maksymalną wytrzymałość narzędzia.

Głowica do rozwiercania precyzyjnego

Niezawodna głowica ModulBore-Plus jest odpowiednia do rozwiercania precyzyjnego od produkcji prototypowej do wielkoseryjnej. Dodatkowy zespół regulacji zgrubnej zapewnia zmienny promień działania głowicy, sięgający 9 mm. Cały program umożliwi obróbkę otworów o średnicach od 21 do 115 mm.

Oprawki narzędziowe do rozwiercania precyzyjnego

Oprawki na głowice do rozwiercania precyzyjnego ModulBore-Plus są przeznaczone do jedno- lub wielostrzowych narzędzi specjalnych lub mostków do mocowania głowic do rozwiercania precyzyjnego w dużym zakresie wytaczania. Nie ma konieczności regulacji wrzeciona maszyny.

Systemy narzędzi ModulBore-Plus

Wytaczadło precyzyjne \varnothing 14 do 23 mm



Głowica do rozwiercania precyzyjnego \varnothing 21 do 115 mm



Kasety do rozwiercania precyzyjnego



ModulBore – adaptery

Złącze MBS

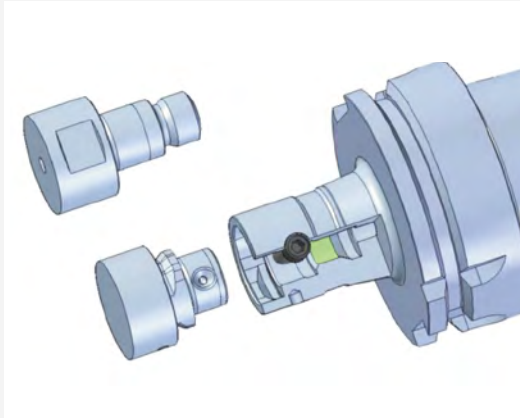

Złącze MBS jest zasadniczym elementem systemu ModulBore. Złącze bagietowe, które zapewnia kontakt między walcem a powierzchnią podparcia głowicy, przenosi duże siły momentu obrotowego. Dwie promieniowe śruby mocujące umożliwiają wstępne naprężenie złącza i obrót narzędzia w obu kierunkach.

ZALETY

- Łatwa obsługa, bezproblemowy montaż i demontaż
- Wysokoprecyzyjne sprzęgło bagietowe z orientacją ostrza
- Niska wartość bicia dzięki stykowi z powierzchnią czołową
- Wewnętrzne doprowadzenie chłodziwa przez złącze do ostrza
- Kompatybilne ze Starflex RFX

Adapter MBS



Adaptory MBS stanowią przejściówkę między złączem maszyny a złączem MBS. Eliminuje to jakiegokolwiek ograniczenia w stosowaniu kompleksowego programu ModuleBore. Program standardowy obejmuje powszechnie stosowane złącza, takie jak stożkowe chwytaki drążone (HSK) czy różne chwytaki stożkowe (SK/BT) w wielu rozmiarach i długościach nominalnych. Ponadto elastyczność systemu jest zwiększona dzięki dostępnym przedłużkom i redukcjom MBS. Możliwa jest produkcja innych adapterów jako narzędzi specjalnych.

Trzpienie nasadzone



Trzpienie nasadzone / trzpienie z rowkiem poprzecznym kombi stanowią podstawę wielu możliwych wariantów narzędzi mostkowych ModulBore. W programie standardowym oferowane są powszechnie stosowane złącza, takie jak stożkowe chwytaki drążone (HSK) czy różne chwytaki stożkowe (SK/BT) i MBS w wielu rozmiarach i długościach nominalnych. Narzędzia mostkowe można ponadto montować na innych przyłączach maszyny, takich jak KM wg DIN ISO 26622 z nasadzanym trzpieniem frezarskim kombi.

ModulBore – przegląd systemu

ModulBore | Adaptery

Adaptery MBS
Strona 636-638

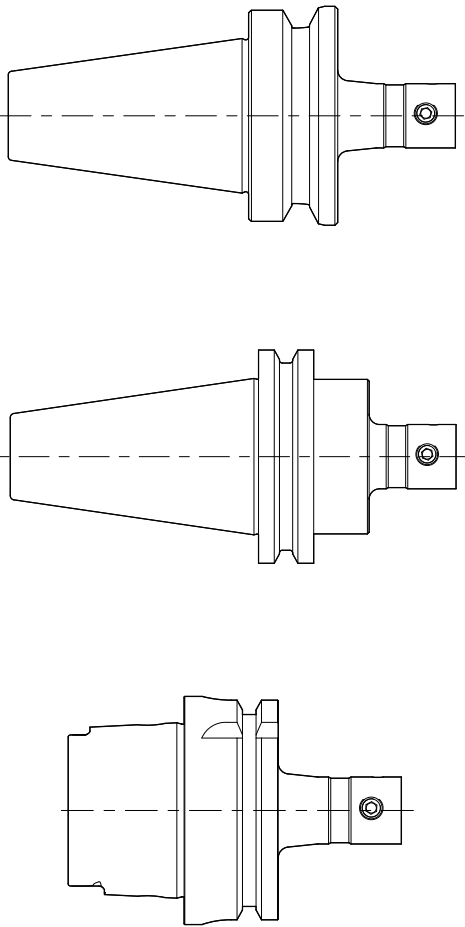

Przedłużki MBS
Strona 639

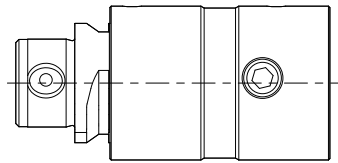

Redukcje MBS
Strona 640

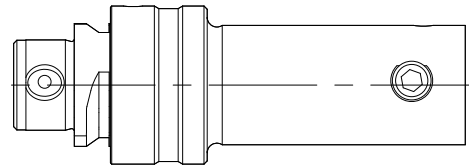

Trzpień z rowkiem poprzecznym MBS
Strona 641

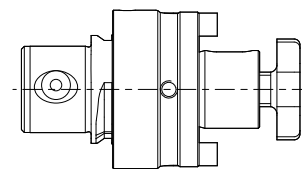

Trzpień nasadzane
patrz katalog TECHNIKA MOCOWANIA

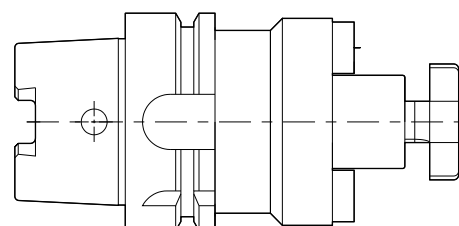

▶ Złącze MBS

▶ Trzpień nasadzany

ModulBore | Powiercanie

Narzędzia dwustronne z systemem MBS

Strona 620

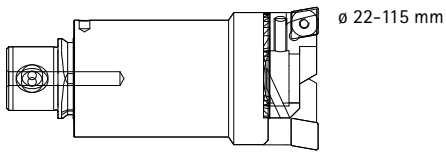

Dostępne również w wersji monolitycznej!

Głowica powierająca z modułem mostkowym

Strona 622

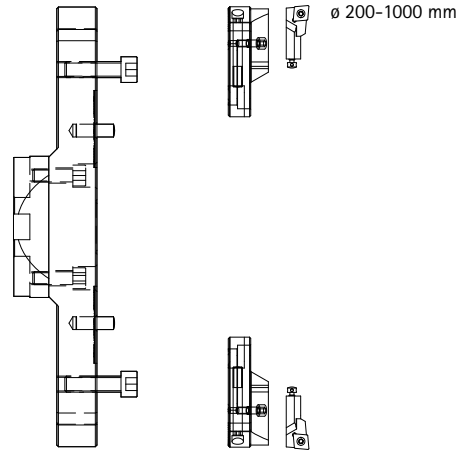
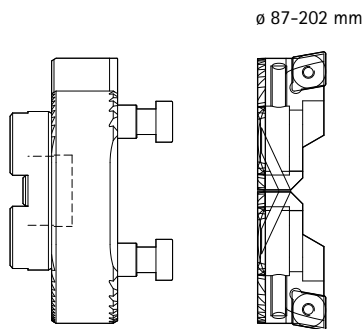

ModulBore | Rozwiercanie precyzyjne

Głowica do rozwiercania precyzyjnego
ModulBore z systemem MBS

Strona 627

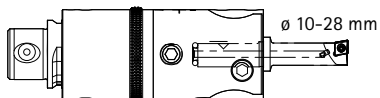
Dostępna również w wersji monolitycznej
ze złączem HSK/SK!Głowica do rozwiercania precyzyjnego
ModulBore-Plus z systemem MBS

Strona 630

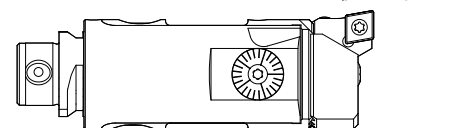
Głowica do rozwiercania precyzyjnego ModulBore z
modułem mostkowym

Strona 631

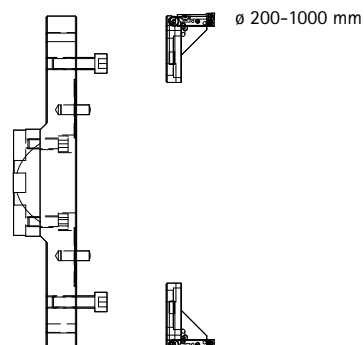
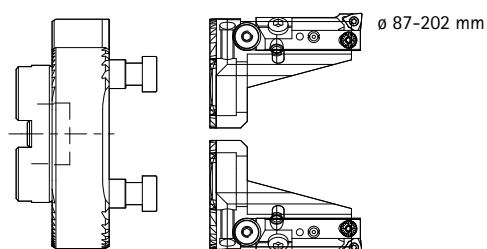

ModulBore – narzędzia dwustrzowe z systemem MBS

Nawiertak do obróbki zgrubnej, korpusy bez kaset WSP
 \varnothing 22-115 mm

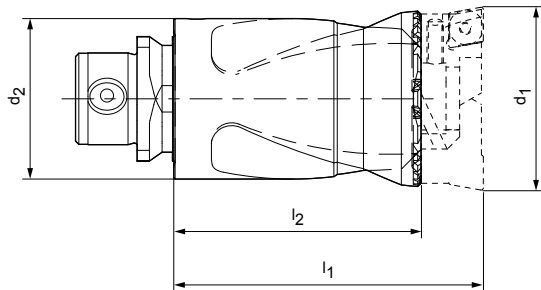

d_1 min. – maks.	d_2 Wielkość MBS	l_1	l_2	sw	Specyfikacja	Nr materiałowy
22 - 30	18,5	40	27,7	17	MBO100-022030-Z2-MBS185	30415217
30 - 39	24,5	50	37,7	22	MBO100-030039-Z2-MBS254	30415218
39 - 50	32	65	48,7	27	MBO100-039050-Z2-MBS320	30415219
50 - 67	42	90	68,2	36	MBO100-050067-Z2-MBS420	30415220
67 - 88	55	115	90,7	46	MBO100-067088-Z2-MBS550	30415221
88 - 115	72	150	113,7	60	MBO100-088115-Z2-MBS720	30415222

Informacje o terminach dostawy dostępne na zapytanie.

Przykład

Przegląd systemu – narzędzia dwustrzowe z systemem MBS \varnothing 22-115 mm

Adapter MBS

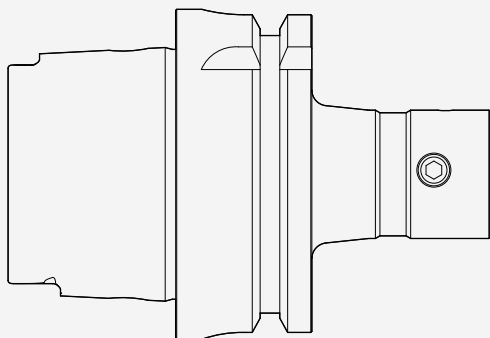

Narzędzia dwustrzowe z systemem MBS

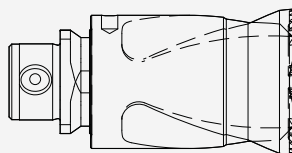

Kasety WSP (uchwyty na płytki)



ModulBore – kasety WSP do narzędzi dwuostrzowych

∅ 22-115 mm

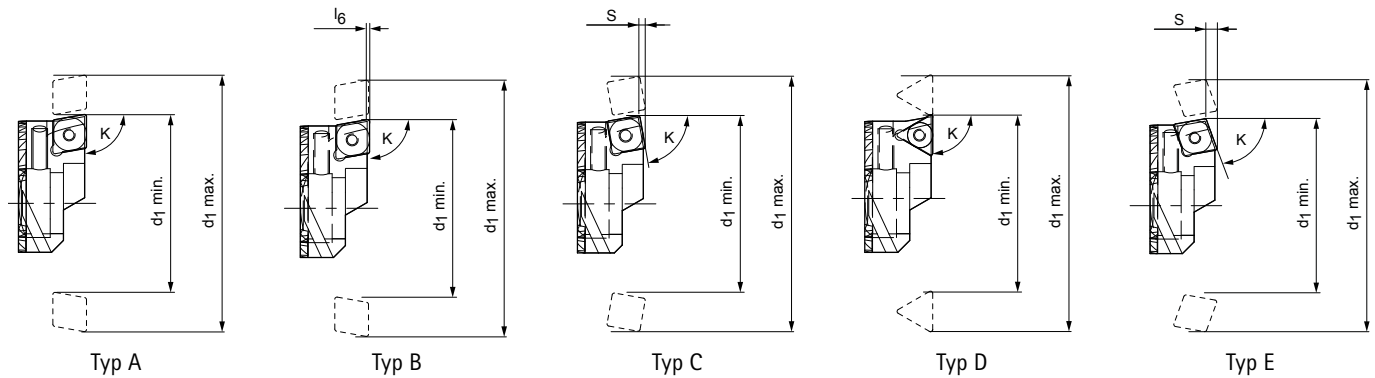

d_1 min. – maks.	Typ	K	Odsadzenie na wysokość l_6	S	WSP	Specyfikacja	Nr materiałowy
22 - 30	A	90°			CC/CP.. 0602	IC-MBO100-022030-A90-C_06	30415185
	B	90°	0,3		CC/CP.. 0602	IC-MBO100-022030-B90-C_06	30415186
	E	70°		2	CC/CP.. 0602	IC-MBO100-022030-E70-C_06	30415187
30 - 39	A	90°			CC/CP.. 0602	IC-MBO100-030039-A90-C_06	30415188
	B	90°	0,3		CC/CP.. 0602	IC-MBO100-030039-B90-C_06	30415189
	C	80°		2	SP.. 0703	IC-MBO100-030039-C80-S_07	30415190
	E	70°		2	CC/CP.. 0602	IC-MBO100-030039-E70-C_06	30415191
39 - 50	A	90°			CC/CP.. 09T3	IC-MBO100-039050-A90-C_09	30415192
	B	90°	0,3		CC/CP.. 09T3	IC-MBO100-039050-B90-C_09	30415193
	C	80°		1,5	SC/SP.. 09T3	IC-MBO100-039050-C80-S_09	30415194
	D	90°			TC/TP.. 09T3	IC-MBO100-039050-D90-T_09	30415195
	E	70°		3,1	CC/CP.. 09T3	IC-MBO100-039050-E70-C_09	30415196
50 - 67	A	90°			CC/CP.. 1204	IC-MBO100-050067-A90-C_12	30415197
	B	90°	0,3		CC/CP.. 1204	IC-MBO100-050067-B90-C_12	30415198
	C	80°		2,1	SC/SP.. 09T3	IC-MBO100-050067-C80-S_09	30415199
	D	90°			TC/TP.. 09T3	IC-MBO100-050067-D90-T_09	30415200
	E	70°		4,1	CC/CP.. 1204	IC-MBO100-050067-E70-C_12	30415201
67 - 88	A	90°			CC/CP.. 1204	IC-MBO100-067088-A90-C_12	30415202
	B	90°	0,3		CC/CP.. 1204	IC-MBO100-067088-B90-C_12	30415203
	C	80°		2,1	SC/SP.. 1204	IC-MBO100-067088-C80-S_12	30415204
	D	90°			TNM.. 16T3	IC-MBO100-067088-D90-T_16	30415205
	E	70°		4,1	CC/CP.. 1204	IC-MBO100-067088-E70-C_12	30415206
88 - 115	A	90°			CC/CP.. 1204	IC-MBO100-088115-A90-C_12	30415207
	B	90°	0,3		CC/CP.. 1204	IC-MBO100-088115-B90-C_12	30415208
	C	80°		2,5	SC/SP.. 1204	IC-MBO100-088115-C80-S_12	30415209
	D	90°			TNM.. 2204	IC-MBO100-088115-D90-T_22	30415210
	E	70°		4,1	CC/CP.. 1204	IC-MBO100-088115-E70-C_12	30415211

Wymagana ilość zamówienia: 2 sztuki

Informacje o terminach dostawy dostępne na zapytanie.

ModulBore – głowica powiercająca z modułem mostkowym

Nawiertak do obróbki zgrubnej, korpusy narzędzi bez kaset WSP

Ø 87-202 mm

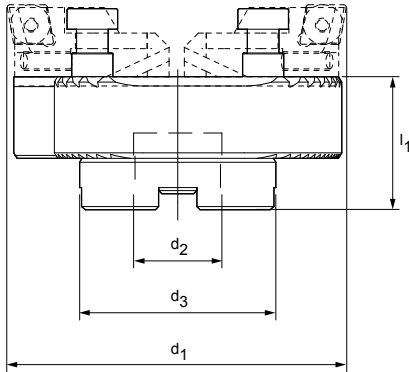

d_1 min. – maks.	d_2	d_3	l_1	Specyfikacja	Nr materiałowy
87 - 110	27	61,5	42	MB0110-087110-Z2-CA27	30415224
109 - 133	27	61,5	42	MB0110-109133-Z2-CA27	30415225
132 - 156	27	62	42	MB0110-132156-Z2-CA27	30415226
155 - 179	27	62	42	MB0110-155179-Z2-CA27	30415227
178 - 202	27	62	42	MB0110-178202-Z2-CA27	30415228

Informacje o terminach dostawy dostępne na zapytanie.

Przykład

Przegląd systemu – głowica powiercająca z modułem mostkowym Ø 87-202 mm

Adapter MBS

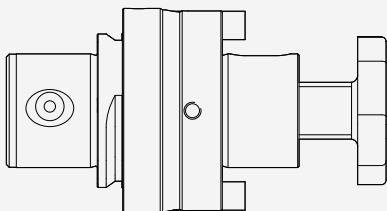

Moduł mostkowy

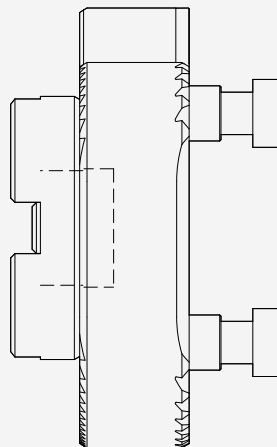

Kasety WSP (uchwyty na płytki)

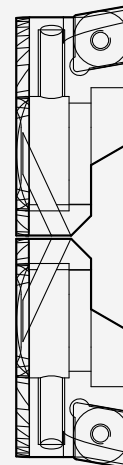

ModulBore – kasety WSP do narzędzi dwuostrzowych

∅ 87-202 mm

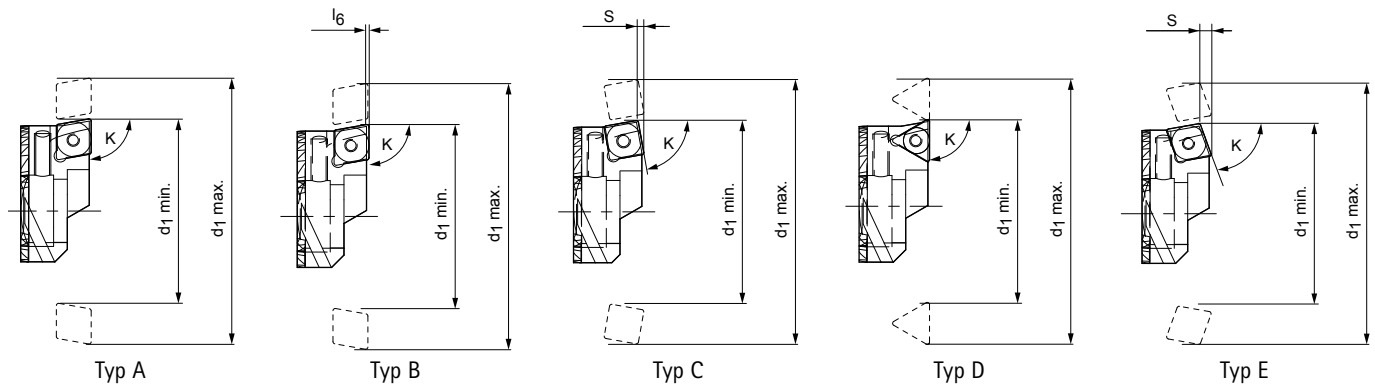

d_1 min. – maks.	Typ	K	Odsadzenie na wysokość l_6	S	WSP	Specyfikacja	Nr materiałowy
87 - 202	A	90°			CC/CP.. 1204	IC-MBO100-067088-A90-C_12	30415202
	B	90°	0,3		CC/CP.. 1204	IC-MBO100-067088-B90-C_12	30415203
	C	80°		2,1	SC/SP.. 1204	IC-MBO100-067088-C80-S_12	30415204
	D	90°			TNM.. 16T3	IC-MBO100-067088-D90-T_16	30415205
	E	70°		4,1	CC/CP.. 1204	IC-MBO100-067088-E70-C_12	30415206

Wymagana ilość zamówienia: 2 sztuki

Informacje o terminach dostawy dostępne na zapytanie.

ModulBore – głowica powiercająca z modułem mostkowym

Nawiertak do obróbki zgrubnej, bez sanek i opravek narzędziowych
 \varnothing 200–520 mm

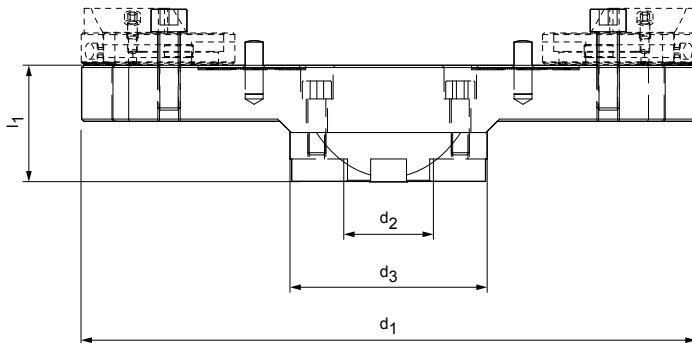

d_1 min. – maks.	d_2	d_3	l_1	Specyfikacja	Nr materiałowy
200 – 280	40	88	51	MB0120-200280-Z2-CA40	30415229
280 – 360	40	88	51	MB0120-280360-Z2-CA40	30415230
360 – 440	40	88	61	MB0120-360440-Z2-CA40	30415231
440 – 520	40	88	61	MB0120-440520-Z2-CA40	30415232

Informacje o terminach dostawy dostępne na zapytanie.

ModulBore – głowica powiercająca z modułem mostkowym

Nawiertak do obróbki zgrubnej, wersja wzmocniona z aluminium, bez sanek i opravek narzędziowych
 \varnothing 358–1000 mm

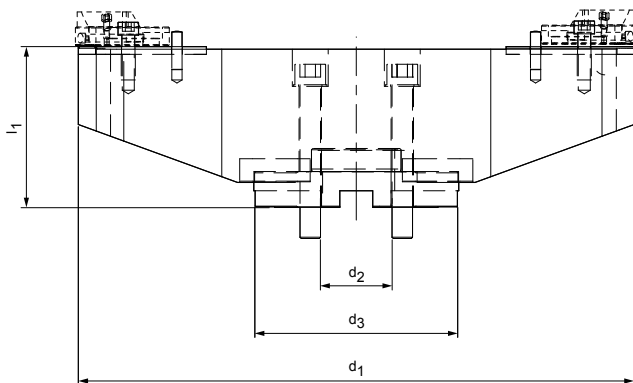

d_1 min. – maks.	d_2	d_3	l_1	Specyfikacja	Nr materiałowy
358 – 440	60	130	91	MB0130-358440-Z2-CA60	30415233
438 – 520	60	130	126	MB0130-438520-Z2-CA60	30415234
518 – 600	60	130	126	MB0130-518600-Z2-CA60	30415235
598 – 680	60	130	126	MB0130-598680-Z2-CA60	30415236
678 – 760	60	130	126	MB0130-678760-Z2-CA60	30415237
758 – 840	60	130	126	MB0130-758840-Z2-CA60	30415238
838 – 920	60	130	126	MB0130-838920-Z2-CA60	30415239
918 – 1000	60	130	126	MB0130-918000-Z2-CA60	30415240

Informacje o terminach dostawy dostępne na zapytanie.

Wymiary podano w mm.

ModulBore – sanki do mocowania wkładek nożowych ISO

∅ 200-1000 mm

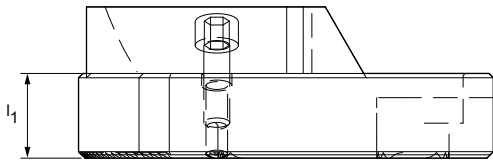

Do ∅ narzędzia d_1	l_1	Specyfikacja	Nr materiałowy
200 - 1.000	19,4	SL-MBO140-2001000	30415309

Informacje o terminach dostawy dostępne na zapytanie.

ModulBore – oprawki narzędziowe ISO

∅ 200-1000 mm

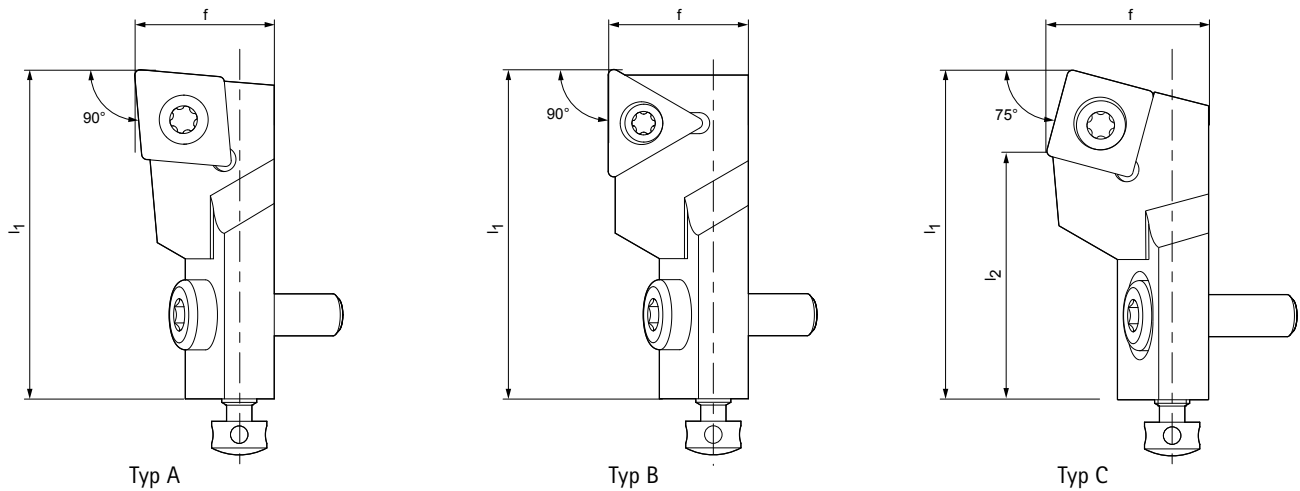

Typ	f	l_1	l_2	Płytki skrawające	Specyfikacja	Nr materiałowy
A	20	47	-	CC...1204	SCLCL12CA-12	30011071
B	20	47	-	TC16T3	STGCL12CA-16	30011077
C	20	47	35,409	SC...1204	SSRCL12CA-12	30011103

Informacje o terminach dostawy dostępne na zapytanie.

Osprzęt – patrz strona 660.

Wymiary podano w mm.

Przykład

Przegląd systemu – głowica powiercająca z modułem mostkowym

ø 200-1000 mm

Adapter

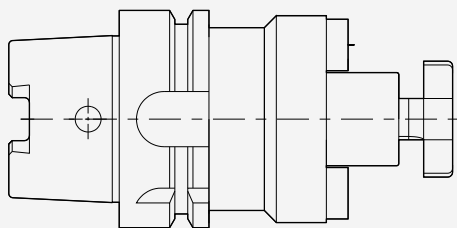

Moduł mostkowy

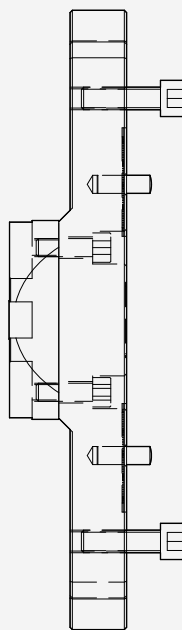

Sanki + oprawka narzędziowa ISO

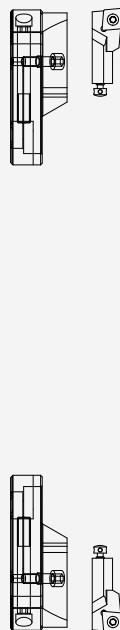

ModulBore – głowica do rozwiercania precyzyjnego

Wytaczak do obróbki precyzyjnej, korpus narzędzia bez wytaczadła
 \varnothing 10–28 mm

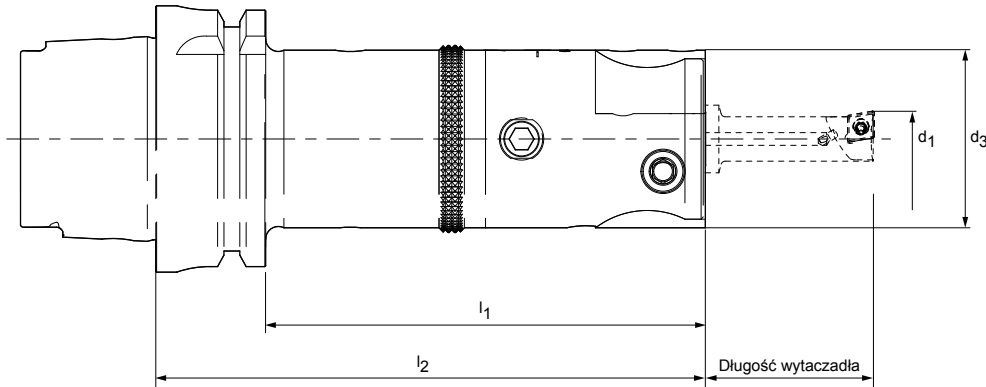

d_1 min. – maks.	Trzon	d_3	l_1	l_2	Specyfikacja	Nr materiałowy
10 - 28	MBS	42		95	MBO201-006028-Z1-MBS420	30415248
	MAS BT40	42	76	103	MBO201-006028-Z1-BT040	30415241
	SK40	42	84	103	MBO201-006028-Z1-SK040	30415249
	HSK-A40	42	110	130	MBO201-006028-Z1-HSK-A040	30415242
	HSK-A50	42	104	130	MBO201-006028-Z1-HSK-A050	30415243
	HSK-A63	42	104	130	MBO201-006028-Z1-HSK-A063	30415244
	HSK-A80	42	104	130	MBO201-006028-Z1-HSK-A080	30415245
	HSK-A100	42	101	130	MBO201-006028-Z1-HSK-A100	30415246
	KM40	42		100	MBO201-006028-Z1-KM40	30415247

Zakres regulacji zgrubnej $d_1 = 3$ mm | Zakres regulacji dokładnej $d_1 = 0,4$ mm

Informacje o terminach dostawy dostępne na zapytanie.

Przykład

Przegląd systemu MBS – głowica do rozwiercania precyzyjnego \varnothing 10–28 mm

Adapter

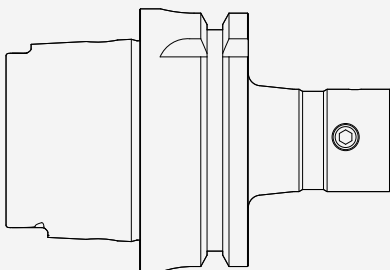

Głowica do rozwiercania precyzyjnego z systemem MBS

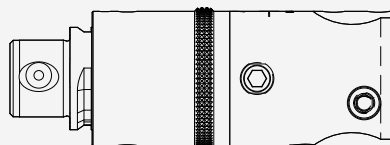

Wytaczadło

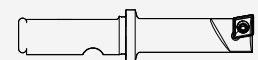

ModulBore – wytaczadła do głowicy do rozwiercania precyzyjnego

Wytaczadło do głowicy do rozwiercania precyzyjnego, z wewnętrznym doprowadzeniem chłodziwa

∅ 10–28 mm

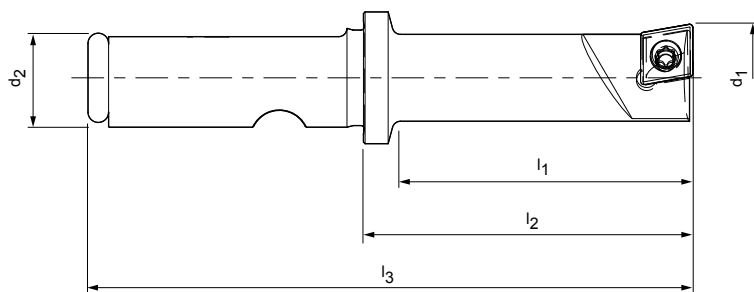

d_1 min. – maks.	d_2	l_1	l_2	l_3	WSP	Specyfikacja	Nr materiałowy
10 - 13	12	30	35	70	CC.. 0602	MB0211-010013-Z1-22	30415260
13 - 16	12	35	40	75	CC.. 0602	MB0211-013016-Z1-22	30415261
16 - 19	12	40	45	80	CC.. 0602	MB0211-016019-Z1-22	30415262
19 - 22	12	50	55	90	CC.. 0602	MB0211-019022-Z1-22	30415263
22 - 25	12	60	65	100	CC.. 0602	MB0211-022025-Z1-22	30415264
25 - 28	12	70	75	110	CC.. 0602	MB0211-025028-Z1-22	30415265

Informacje o terminach dostawy dostępne na zapytanie.

ModulBore-Plus – wytaczadło precyzyjne

Wytaczak do obróbki precyzyjnej, z wewnętrznym doprowadzeniem chłodziwa
 \varnothing 14–23 mm

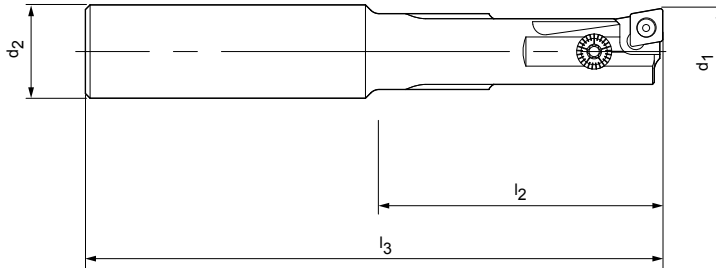

d ₁	d ₂	l ₂	l ₃	WSP	Specyfikacja	Nr materiałowy
14,0	16	48	99	CC.. 0602	MB0311-0140-Z1-WC16	30415266
14,5	16	48	99	CC.. 0602	MB0311-0145-Z1-WC16	30415267
15,0	16	48	99	CC.. 0602	MB0311-0150-Z1-WC16	30415268
15,5	16	48	99	CC.. 0602	MB0311-0155-Z1-WC16	30415269
16,0	20	54	107	CC.. 0602	MB0311-0160-Z1-WC20	30415270
16,5	20	54	107	CC.. 0602	MB0311-0165-Z1-WC20	30415271
17,0	20	54	107	CC.. 0602	MB0311-0170-Z1-WC20	30415272
17,5	20	54	107	CC.. 0602	MB0311-0175-Z1-WC20	30415273
18,0	20	60	113	CC.. 0602	MB0311-0180-Z1-WC20	30415274
18,5	20	60	113	CC.. 0602	MB0311-0185-Z1-WC20	30415275
19,0	20	60	113	CC.. 0602	MB0311-0190-Z1-WC20	30415276
19,5	20	60	113	CC.. 0602	MB0311-0195-Z1-WC20	30415277
20,0	20	70	125	CC.. 0602	MB0311-0200-Z1-WC20	30415278
20,5	20	70	125	CC.. 0602	MB0311-0205-Z1-WC20	30415279
21,0	20	70	125	CC.. 0602	MB0311-0210-Z1-WC20	30415280
21,5	20	70	125	CC.. 0602	MB0311-0215-Z1-WC20	30415281
22,0	20	70	125	CC.. 0602	MB0311-0220-Z1-WC20	30415282
22,5	20	70	125	CC.. 0602	MB0311-0225-Z1-WC20	30415284
23,0	20	70	125	CC.. 0602	MB0311-0230-Z1-WC20	30415283

Zakres regulacji średnicy znamionowej d₁ $\begin{matrix} +0,3 \text{ mm} \\ -0,1 \text{ mm} \end{matrix}$

Informacje o terminach dostawy dostępne na zapytanie.

ModulBore-Plus – głowica do rozwiercania precyzyjnego z systemem MBS

Wytaczak do obróbki precyzyjnej, z wewnętrznym doprowadzeniem chłodziwa

Ø 21-115 mm

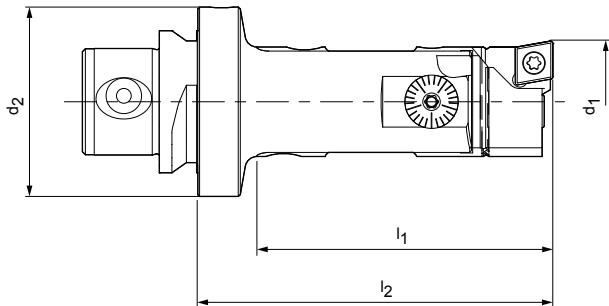

Dostępne na zapytanie

d_1 min. – maks.	d_2 Wielkość MBS	l_1	l_2	WSP	Specyfikacja	Nr materiałowy
21 - 29	32	50	60	CC.. 0602	MBO401-021029-Z1-MBS320	30415285
29 - 39	24,5	65	65	CC.. 0602	MBO401-029039-Z1-MBS245	30415286
38 - 50	32	75	75	CC.. 0602	MBO401-038050-Z1-MBS320	30415287
50 - 65	42	95	95	CC.. 0602	MBO401-050065-Z1-MBS420	30415289
65 - 88	55	120	120	CC.. 0602	MBO401-065088-Z1-MBS550	30415291
88 - 115	72	150	150	CC.. 0602	MBO401-088115-Z1-MBS720	30415294

Zakres regulacji zgrubnej d_1 – patrz tabela | Zakres regulacji dokładnej $d_1 = 0,4$ mm

Informacje o terminach dostawy dostępne na zapytanie.

ModulBore – Głowica do rozwiercania precyzyjnego z modu- łem mostkowym

Wytaczak do obróbki precyzyjnej, bez sanek i oprawek na głowice do rozwiercania precyzyjnego

Ø 87-202 mm

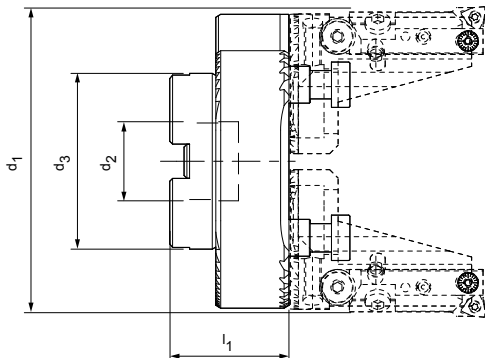

d_1 min. – maks.	d_2	d_3	l_1	Specyfikacja	Nr materiałowy
87 - 110	27	61,5	42	MB0110-087110-Z2-CA27	30415224
109 - 133	27	61,5	42	MB0110-109133-Z2-CA27	30415225
132 - 156	27	62	42	MB0110-132156-Z2-CA27	30415226
155 - 179	27	62	42	MB0110-155179-Z2-CA27	30415227
178 - 202	27	62	42	MB0110-178202-Z2-CA27	30415228

Informacje o terminach dostawy dostępne na zapytanie.

ModulBore – sanki do oprawek na głowice do rozwiercania precyzyjnego

Ø 87-202 mm

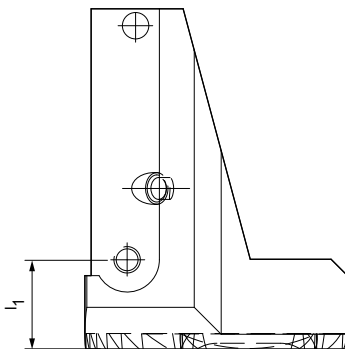

Do Ø narzędzia d_1	l_1	Specyfikacja	Nr materiałowy
87 - 202	16,9	SL-MB0150-087202	30415310

Informacje o terminach dostawy dostępne na zapytanie.

Przykład

Przegląd systemu – głowica do rozwiercania precyzyjnego z modułem mostkowym $\varnothing 87-202$ mm

Adapter

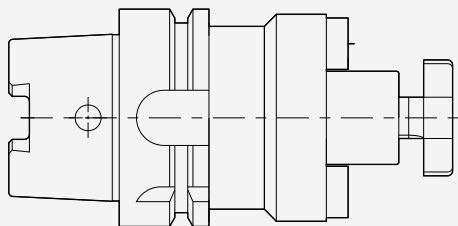

Moduł mostkowy

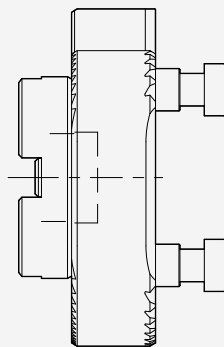

Sanki + oprawka na głowice do rozwiercania precyzyjnego

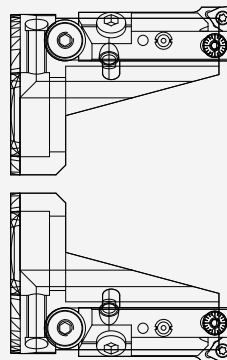

ModulBore – Głowica do rozwiercania precyzyjnego z modu- łem mostkowym

Wytaczak do obróbki precyzyjnej, bez sanek i oprawek na głowice do rozwiercania precyzyjnego

Ø 200–520 mm

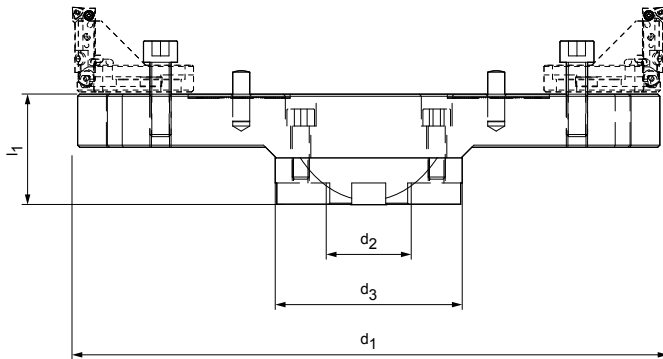

d_1 min. – maks.	d_2	d_3	l_1	Specyfikacja	Nr materiałowy
200 - 280	40	88	51	MB0120-200280-Z2-CA40	30415229
280 - 360	40	88	51	MB0120-280360-Z2-CA40	30415230
360 - 440	40	88	61	MB0120-360440-Z2-CA40	30415231
440 - 520	40	88	61	MB0120-440520-Z2-CA40	30415232

Informacje o terminach dostawy dostępne na zapytanie.

ModulBore – Głowica do rozwiercania precyzyjnego z modu- łem mostkowym

Nawiertak do obróbki precyzyjnej, wersja wzmocniona z aluminium, bez sanek i oprawek na
głowice do rozwiercania precyzyjnego

Ø 358–1000 mm

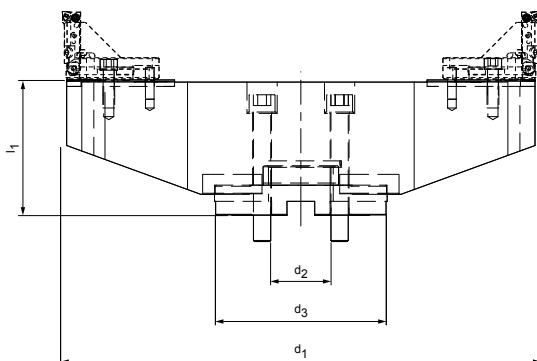

d_1 min. – maks.	d_2	d_3	l_1	Specyfikacja	Nr materiałowy
358 - 440	60	130	91	MB0130-358440-Z2-CA60	30415233
438 - 520	60	130	126	MB0130-438520-Z2-CA60	30415234
518 - 600	60	130	126	MB0130-518600-Z2-CA60	30415235
598 - 680	60	130	126	MB0130-598680-Z2-CA60	30415236
678 - 760	60	130	126	MB0130-678760-Z2-CA60	30415237
758 - 840	60	130	126	MB0130-758840-Z2-CA60	30415238
838 - 920	60	130	126	MB0130-838920-Z2-CA60	30415239
918 - 1.000	60	130	126	MB0130-918000-Z2-CA60	30415240

Informacje o terminach dostawy dostępne na zapytanie.

Wymiary podano w mm.

ModulBore – sanki do mocowania oprawek na głowice do rozwiercania precyzyjnego \varnothing 200-1000 mm

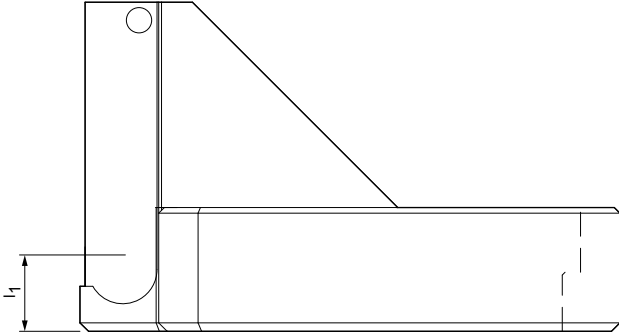

Do \varnothing narzędzia d_1	l_1	Specyfikacja	Nr materiałowy
200 - 1.000	13,1	SL-MBO150-2001000	30415311

Odpowiednia przeciwwaga do obróbki wrzecionem jednostrzowym – nr materiałowy 30522418.
Informacje o terminach dostawy dostępne na zapytanie.

Przykład

Przegląd systemu – głowica do rozwiercania precyzyjnego z modułem mostkowym \varnothing 200-1000 mm

Adapter

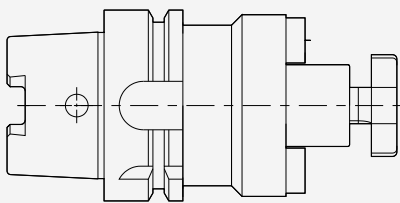

Moduł mostkowy

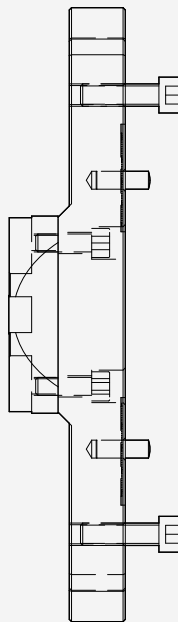

Sanki + oprawka na głowice do rozwiercania precyzyjnego + przeciwwaga

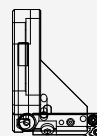
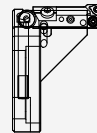

ModulBore – oprawki na głowice do rozwiercania precyzyjnego $\varnothing 87-1000$ mm

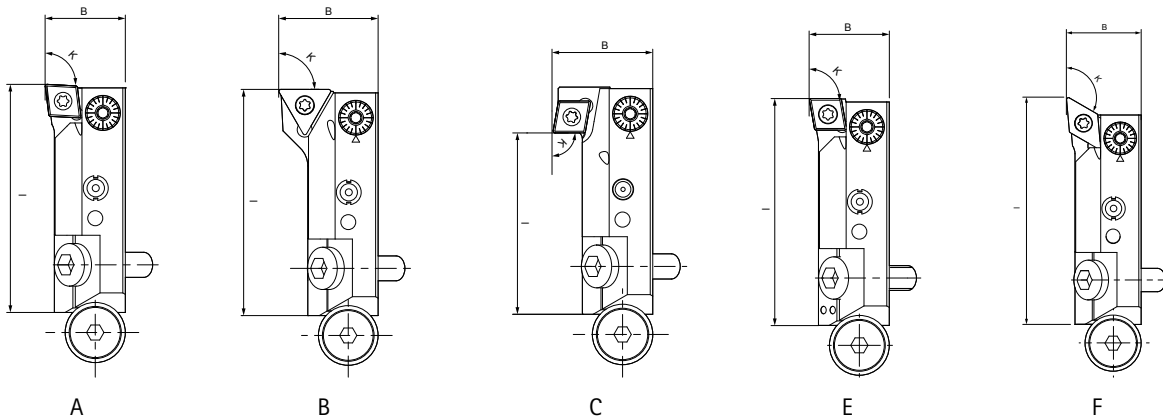

Typ	l	B	K	Wersja	WSP	Specyfikacja	Nr materiałowy
A	45,5	16	93°	w prawo	CC..0602	MBO501-R-093-16-CC_0602	10030384
A	45,5	16	93°	w lewo	CC..0602	MBO501-L-093-16-CC_0602	30415298
B	45,5	20	90°	w prawo	TC..1102	MBO501-R-090-20-TC_1102	30355664
B	45,5	20	90°	w lewo	TC..1102	MBO501-L-090-20-TC_1102	30353989
C	36	20	90°	do tyłu	CC..0602	MBO501-B-090-20-CC_0602	30415297
A	45,5	16	95°	w prawo	CC..0602	MBO501-R-095-16-CC_0602	10078197
A	45,5	16	95°	w lewo	CC..0602	MBO501-L-095-16-CC_0602	30415299
E	45,5	16	90°	w prawo	CC..0602	MBO501-R-090-16-CC_0602	10078198
E	45,5	16	90°	w lewo	CC..0602	MBO501-L-090-16-CC_0602	10078199

Z precyzyjną regulacją 10 μ m | Skok regulacyjny w odniesieniu do wymiaru B + 0,6 mm \varnothing
 Informacje o terminach dostawy dostępne na zapytanie.

Dostępne na zapytanie

Typ	l	B	k	Wersja	WSP	Specyfikacja	Nr materiałowy
F	48,5	16	120° (5°)	w lewo	DC..0702	MBO501-L-120-16-DC_0702	30415305
F	45,8	16	120° (5°)	w prawo	DC..0702	MBO501-R-120-16-DC_0702	30415302
A	45,5	22	95°	w lewo	CC..09T3	MBO501-L-095-22-CC_09T3	30415304
A	45,5	22	95°	w prawo	CC..09T3	MBO501-R-095-22-CC_09T3	30415301

ModulBore-Plus – oprawki na głowice do rozwiercania precyzyjnego

Typ	l	B	K	Wersja	WSP	Specyfikacja	Nr materiałowy
A	45,5	16	93°	w prawo	CC..0602	MBO511-R-093-16-CC_0602	30415307
A	45,5	16	95°	w prawo	CC..0602	MBO511-R-095-16-CC_0602	30415308
A	45,5	16	90°	w prawo	CC..0602	MBO511-R-090-16-CC_0602	30415306

Z precyzyjną regulacją 2 μ m | Skok regulacyjny w odniesieniu do wymiaru B + 0,5 mm \varnothing
 Informacje o terminach dostawy dostępne na zapytanie.

Adaptory MBS

Chwył SK według ISO 7388-1 typ AD/AF

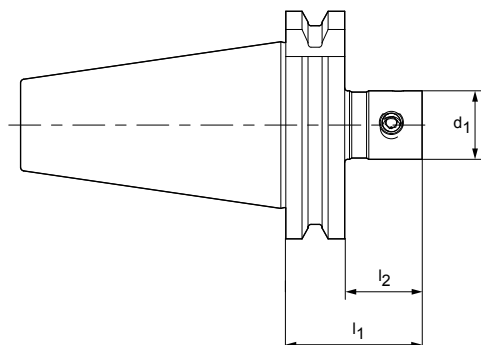

SK	d_1 Wielkość MBS	l_1	l_2	Specyfikacja	Nr materiałowy
40	18,5	60	40	MBS101-N-185-040-SK040-S	30415332
40	24,5	60	40	MBS101-N-245-060-SK040-S	30415333
40	32	60	40	MBS101-N-320-060-SK040-S	30415334
40	42	60	40	MBS101-N-420-060-SK040-S	30415335
40	55	65	45	MBS101-N-550-065-SK040-S	30415336
50	18,5	40	20	MBS101-N-185-040-SK050-S	30415337
50	24,5	40	20	MBS101-N-245-040-SK050-S	30415338
50	32	60	40	MBS101-N-320-060-SK050-S	30415339
50	42	60	40	MBS101-N-420-060-SK050-S	30415340
50	55	60	40	MBS101-N-550-060-SK050-S	30415341
50	72	65	45	MBS101-N-720-065-SK050-S	30415342

Informacje o terminach dostawy dostępne na zapytanie.

Adapter MBS

Chwył BT według ISO 7388-2 typ J (JIS B 6339)

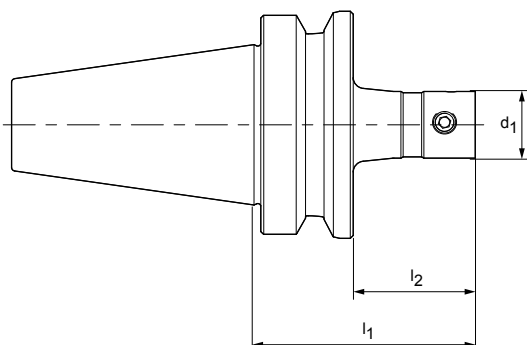

BT	d_1 Wielkość MBS	l_1	l_2	Specyfikacja	Nr materiałowy
40	18,5	40	33	MBS101-N-185-060-BT040-S	30415344
40	24,5	40	33	MBS101-N-245-060-BT040-S	30415345
40	32	60	33	MBS101-N-320-060-BT040-S	30415346
40	42	60	33	MBS101-N-420-060-BT040-S	30415347
40	55	60	33	MBS101-N-550-065-BT040-S	30415348
50	18,5	40	-	MBS101-N-185-040-BT050-S	30415349
50	24,5	40	-	MBS101-N-245-040-BT050-S	30415350
50	32	60	22	MBS101-N-320-060-BT050-S	30415351
50	42	60	22	MBS101-N-420-060-BT050-S	30415352
50	55	60	27	MBS101-N-550-065-BT050-S	30415353
50	72	60	32	MBS101-N-720-070-BT050-S	30415354

Informacje o terminach dostawy dostępne na zapytanie.

Adapter MBS

Chwyt HSK-A według DIN 69893-1

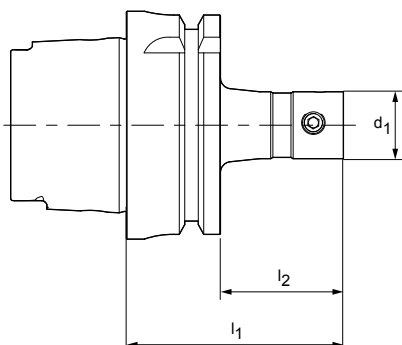

HSK-A	d_1 Wielkość MBS	l_1	l_2	Specyfikacja	Nr materiałowy
63	18,5	60	34	MBS101-N-185-060-HSK-A063-S	30415367
63	24,5	60	34	MBS101-N-245-060-HSK-A063-S	30415368
63	32	60	34	MBS101-N-320-060-HSK-A063-S	30415369
63	42	70	44	MBS101-N-420-070-HSK-A063-S	30415370
63	55	80	54	MBS101-N-550-080-HSK-A063-S	30415371
63	72	95	69	MBS101-N-720-095-HSK-A063-S	30415372
100	32	70	41	MBS101-N-320-070-HSK-A100-S	30415373
100	42	80	51	MBS101-N-420-080-HSK-A100-S	30415374
100	55	90	61	MBS101-N-420-550-HSK-A100-S	30415375
100	72	105	76	MBS101-N-720-105-HSK-A100-S	30415376

Informacje o terminach dostawy dostępne na zapytanie.

Przedłużki MBS

Z MBS na MBS

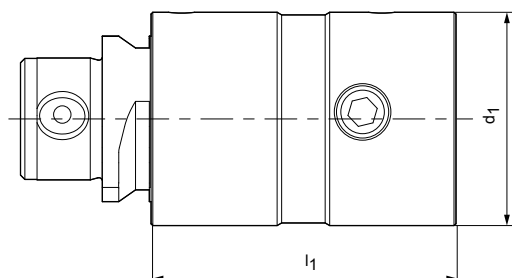

d ₁ Wielkość MBS	l ₁	Specyfikacja	Nr materiałowy
18,5	30	MBS185-MBS185-030-01	30415380
18,5	35	MBS185-MBS185-035-01	30415381
24,5	30	MBS245-MBS245-030-01	30415382
24,5	35	MBS245-MBS245-035-01	30415383
24,5	45	MBS245-MBS245-045-01	30415384
32	40	MBS320-MBS320-040-01	30415385
32	50	MBS320-MBS320-050-01	30415386
32	60	MBS320-MBS320-060-01	30415387
42	50	MBS420-MBS420-050-01	30415388
42	60	MBS420-MBS420-060-01	30415389
42	80	MBS420-MBS420-080-01	30415390
55	70	MBS550-MBS550-070-01	30415391
55	90	MBS550-MBS550-090-01	30415392
55	105	MBS550-MBS550-105-01	30415393
72	75	MBS720-MBS720-075-01	30415394
72	100	MBS720-MBS720-100-01	30415395
72	135	MBS720-MBS720-135-01	30415396

Informacje o terminach dostawy dostępne na zapytanie.

Redukcje MBS

Z MBS na MBS

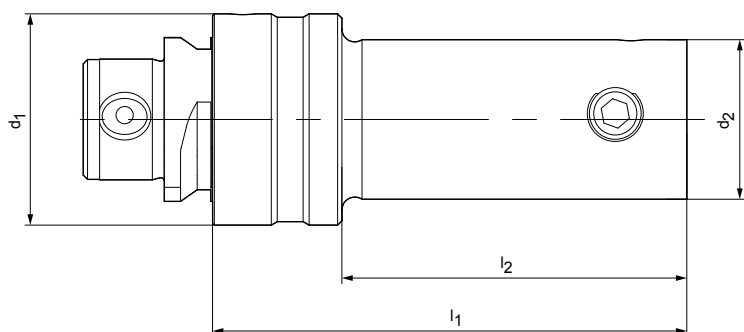

d ₁ Wielkość MBS	d ₂ Wielkość MBS	l ₁	l ₂	Specyfikacja	Nr materiałowy
24,5	18,5	30	15	MBS245-MBS185-030-01	30415399
32	18,5	30	51	MBS320-MBS185-030-01	30415401
32	24,5	40	25	MBS320-MBS245-040-01	30415403
42	18,5	35	15	MBS420-MBS185-035-01	30415405
42	24,5	45	25	MBS420-MBS245-045-01	30415407
42	32	45	25	MBS420-MBS320-045-01	30415409
55	18,5	40	15	MBS550-MBS185-040-01	30415411
55	24,5	50	25	MBS550-MBS245-050-01	30415413
55	32	50	25	MBS550-MBS320-050-01	30415415
55	42	55	30	MBS550-MBS420-055-01	30415417
72	42	60	30	MBS720-MBS420-060-01	30415419
72	55	60	30	MBS720-MBS550-060-01	30415420

Informacje o terminach dostawy dostępne na zapytanie.

ModulBore – trzpienie nasadzane

Z rowkiem poprzecznym i systemem MBS

Chwyt MBS

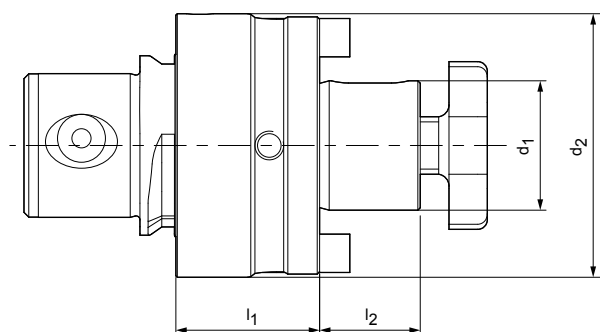

Wielkość MBS	d ₁	d ₂	l ₁	l ₂	Specyfikacja	Nr materiałowy
MBS420	27	42	30	21	MCA-MBS420-27-30-1-0-W	30415312
MBS550	27	55	30	21	MCA-MBS550-27-30-1-0-W	30415313
MBS720	40	72	35	27	MCA-MBS720-40-35-1-0-W	30415314

Informacje o terminach dostawy dostępne na zapytanie.

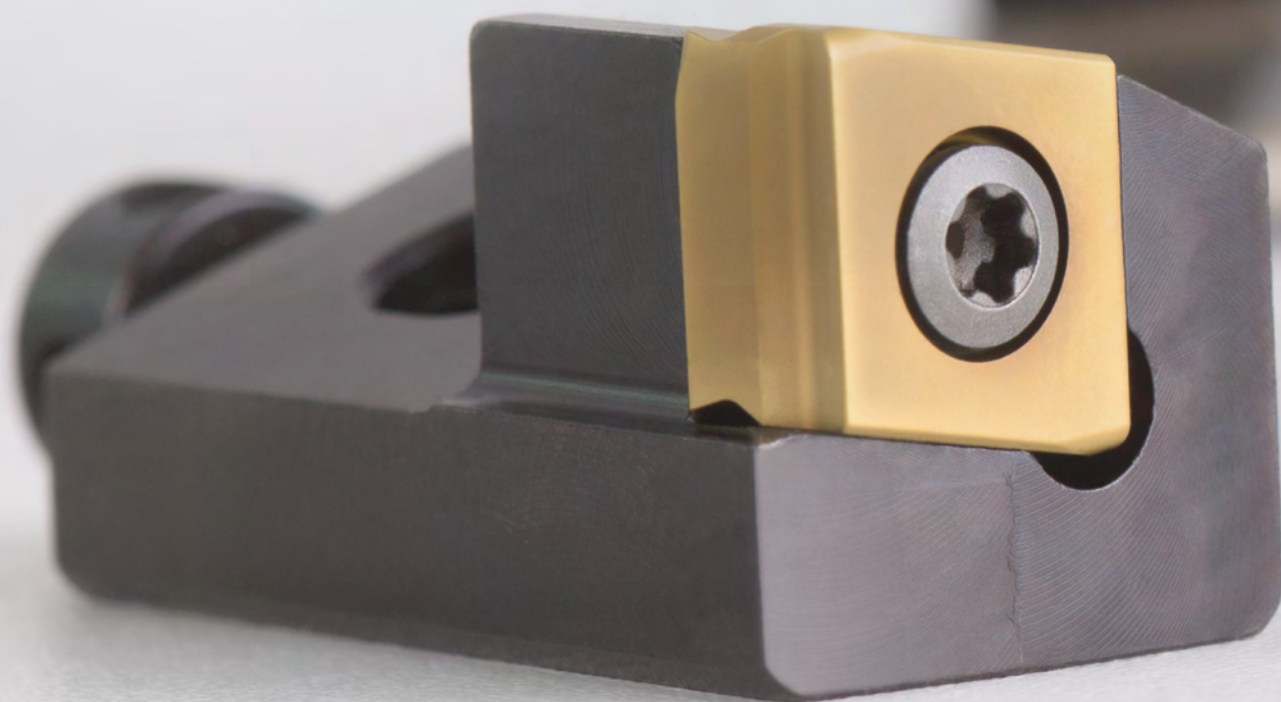

WKŁADKI NOŻOWE

Oprócz regulacji z dużym skokiem nastawczym oprawki narzędziowe oferują wiele możliwości do różnych zastosowań dzięki szybkiej i łatwej wymianie. Oprawki narzędziowe są wykorzystywane zarówno do obróbki zewnętrznej, jak i wewnętrznej. W przypadku zmian, na przykład kątów fazowania, lub konieczności naprawy możliwa jest bezproblemowa wymiana oprawek narzędziowych.

Asortyment oprawek narzędziowych MAPAL pokrywa znaczną część wariantów montażowych konstrukcji. Oprócz standardowych oprawek narzędziowych ISO dostępny jest szereg kompaktowych oprawek narzędziowych na płytki skrawające promieniowe i styczne. Dzięki krótszym długościom konstrukcyjnym oferują one jeszcze większą swobodę projektowania narzędzi specjalnych.

Na zapytanie MAPAL dostarcza również oprawki narzędziowe i kompaktowe oprawki narzędziowe w wersjach specjalnych.

Oprawki narzędziowe

Oznaczenia	644
Oprawki narzędziowe ISO	646
Kompaktowe oprawki narzędziowe	650
Kompaktowe oprawki narzędziowe na płytki skrawające styczne	656
Osprzęt	660

Porównanie wielkości kompaktowych oprawek narzędziowych MAPAL i oprawek narzędziowych ISO

Przykład: wielkość WSP 09

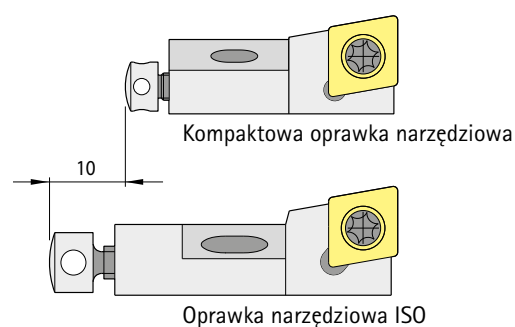

Oznaczenia Oprawki narzędziowe i kompaktowe oprawki narzędziowe

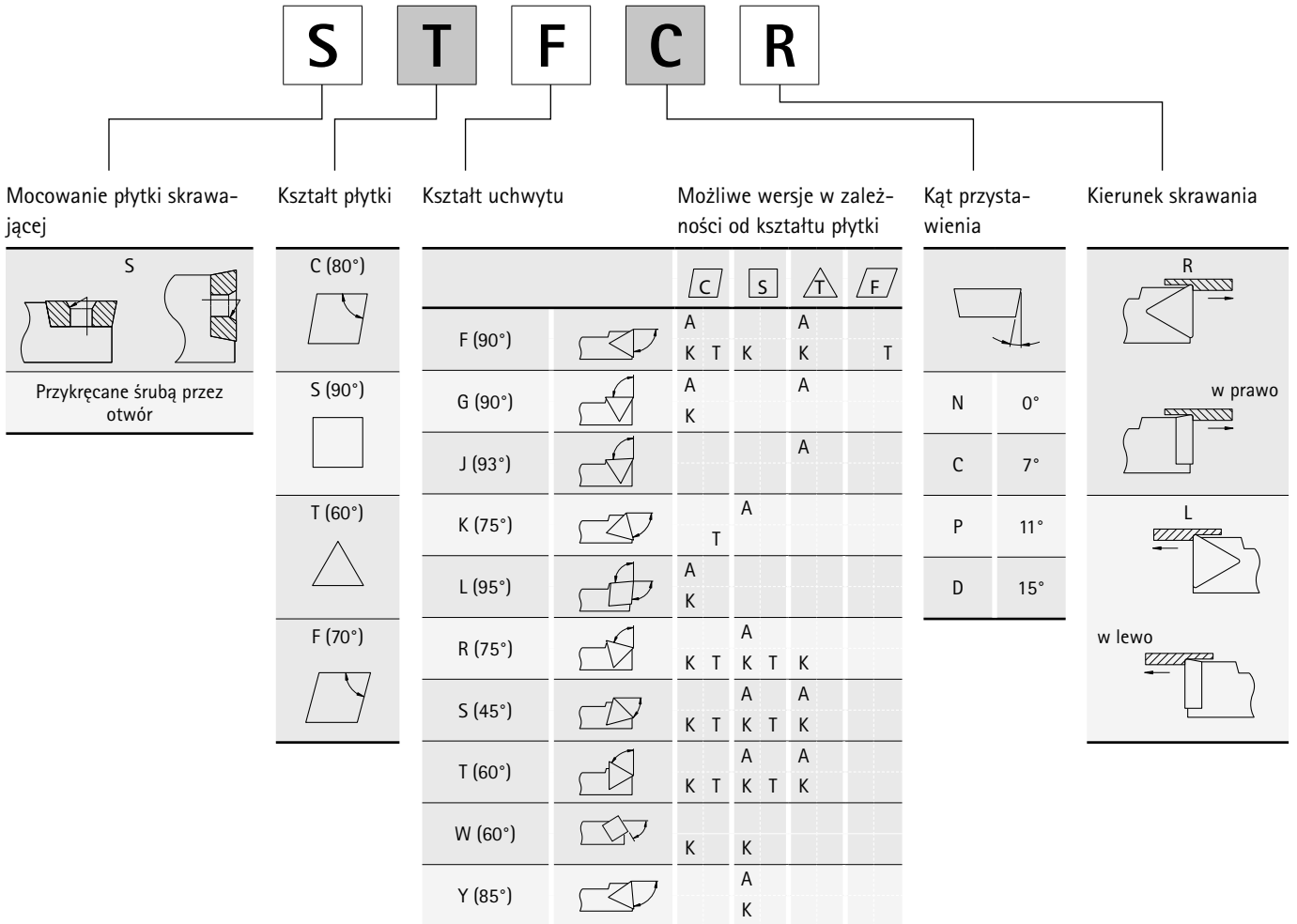

A = oprawka narzędziowa
 K = kompaktowa oprawka narzędziowa
 T = kompaktowa oprawka narzędziowa na płytki skrawające styczne

Kompaktowa oprawka narzędziowa z kątem specjalnym
 Kształt uchwytu określany bezpośrednio na podstawie kąta przystawienia

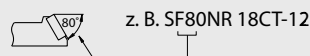
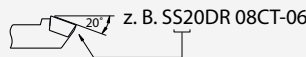

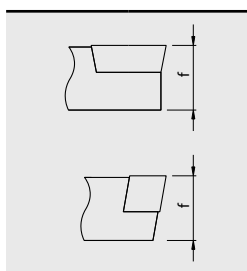
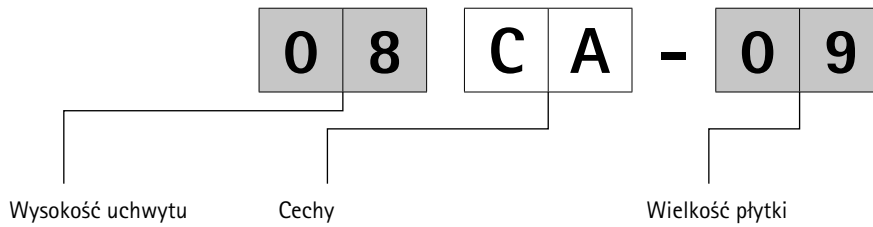

Dane o wysokości	
Wskaźnik	[mm]
06	6,0
08	8,0
10	10,0
12	12,0
14	14,0
18	18,0

1. miejsce	Znaczenie
C	Oprawka narzędziowa (kaset)
2. miejsce	Znaczenie
A	Oprawka narzędziowa wg DIN 4985
K	Kompaktowa oprawka narzędziowa zbliżona do DIN 4985
T	Kompaktowa oprawka narzędziowa zbliżona do DIN 4985 na płytki skrawające styczne

Okrag wewnętrzny				
	C	S	T	F
d [mm]	05	-	09	-
5,56	05	-	09	-
6,35	06	06	11	06
9,525	09	09	16	09
12,7	12	12	-	12

Oprawki narzędziowe ISO

Kształt F, G

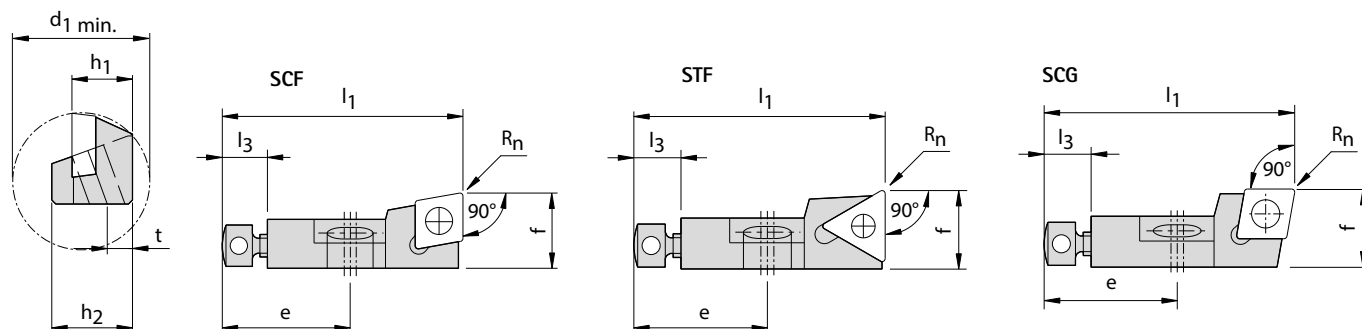

Rysunki narzędzi w wersji prawej – przykład SCFCR.

Magazynowa seria preferowana

	Specyfikacja	Odpowiednia płytka skrawająca	Wymiary									Grupa osprzętu *	Nr materiałowy
			h_1	f (w odniesieniu do R_n)	R_n	l_1	e	l_3	h_2	t	$d_1 \text{ min.}$		
SCF...	SCFCR 08CA-06	CC_0602__	8	10	0,4	32	17	6	9,5	4,5	25	3	30011050
	SCFCL 08CA-06	CC_0602__	8	10	0,4	32	17	6	9,5	4,5	25	3	30011051
	SCFPR 08CA-06	CP_0602__	8	10	0,4	32	17	6	9,5	4,5	25	3	30011052
	SCFPL 08CA-06	CP_0602__	8	10	0,4	32	17	6	9,5	4,5	25	3	30011053
	SCFCR 10CA-09	CC_09T3__	10	14	0,8	50	20	8	13	5	40	5	30011054
	SCFCR 12CA-12	CC_1204__	12	20	0,8	55	20	8	17	6	50	1	30011056
	SCFCL 12CA-12	CC_1204__	12	20	0,8	55	20	8	17	6	50	1	30011057
STF...	STFCR 08CA-09	TC_0902__	8	10	0,4	32	17	6	9,5	4,5	25	2	30011058
	STFCR 10CA-11-02	TC_1102__	10	14	0,4	50	20	8	13	5	40	4	30011060
	STFCR 12CA-16	TC_16T3__	12	20	0,8	55	20	8	17	6	50	6	30011062
SCG...	SCGCR 08CA-06	CC_0602__	8	10	0,4	32	17	6	9,5	4,5	25	3	30011064
	SCGCL 08CA-06	CC_0602__	8	10	0,4	32	17	6	9,5	4,5	25	3	30011065
	SCGCR 10CA-09	CC_09T3__	10	14	0,8	50	20	8	13	5	40	5	30011068

* patrz strony 660-661

Inne położenie ostrza, rozmiary i kąty przystawienia ostrzy dostępne na zapytanie.
 Zakres dostawy: Oprawka narzędziowa z zamontowanymi elementami. Płytki skrawające i osprzęt należy zamawiać oddzielnie.
 Wymiary podano w mm.

Oprawka narzędziowa ISO

Kształt J, K, L

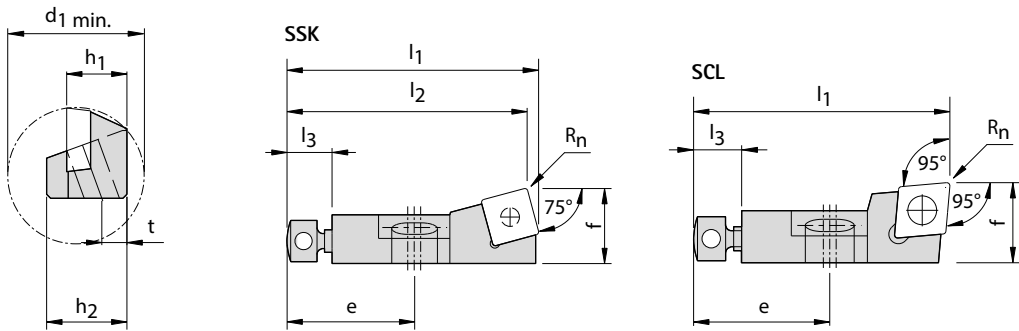

Rysunki narzędzi w wersji prawej – przykład STJCR.

Magazynowa seria preferowana

	Specyfikacja	Odpowiednia płytka skrawająca	Wymiary										Grupa osprzętu *	Nr materiałowy
			h_1	f (w odniesieniu do R_n)	R_n	l_1	l_2	e	l_3	h_2	t	d_1 min.		
SSK...	SSKCR 10CA-09	SC_09T3__	10	14	0,8	52,2	50	20	8	13	5	40	5	30011086
	SSKCL 10CA-09	SC_09T3__	10	14	0,8	52,2	50	20	8	13	5	40	5	30011087
	SSKCR 12CA-12	SC_1204__	12	20	0,8	58,1	55	20	8	17	6	50	1	30011088
SCL...	SCLCR 10CA-09	CC_09T3__	10	14	0,8	50	-	20	8	13	5	40	5	30011094
	SCLCL 10CA-09	CC_09T3__	10	14	0,8	50	-	20	8	13	5	40	5	30011095
	SCLCL 12CA-12	CC_1204__	12	20	0,8	55	-	20	8	17	6	50	1	30011097

* patrz strony 660-661

Inne położenie ostrza, rozmiary i kąty przystawienia ostrzy dostępne na zapytanie.
 Zakres dostawy: Oprawka narzędziowa z zamontowanymi elementami. Płytki skrawające i osprzęt należy zamawiać oddzielnie.
 Wymiary podano w mm.

Oprawka narzędziowa ISO

Kształt R, S

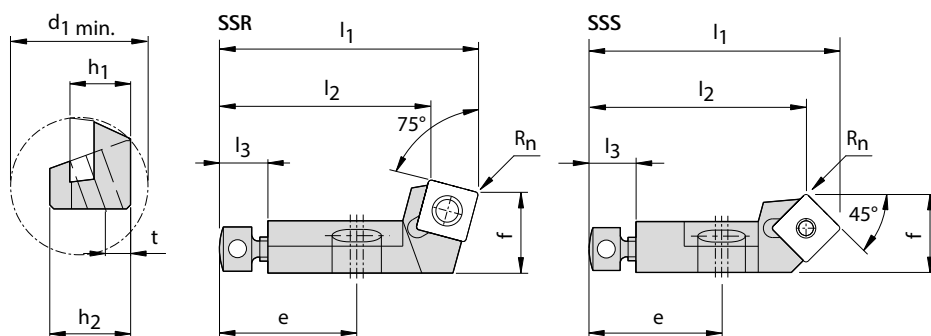

Rysunki narzędzi w wersji prawej – przykład SSRCR.

Magazynowa seria preferowana

	Specyfikacja	Odpowiednia płytka skrawająca	Wymiary										Grupa osprzętu *	Nr materiałowy
			h_1	f (w odniesieniu do R_n)	R_n	l_1	l_2	e	l_3	h_2	t	d_1 min.		
SSR...	SSRCR 08CA-06	SC_0602__	8	10	0,4	32	26,4	17	6	9,5	4,5	25	3	30011098
	SSRCR 10CA-09	SC_09T3__	10	14	0,8	50	41,3	20	8	13	5	40	5	30011100
	SSRCR 12CA-12	SC_1204__	12	20	0,8	55	43,5	20	8	17	6	50	1	30011102
	SSRCL 12CA-12	SC_1204__	12	20	0,8	55	43,5	20	8	17	6	50	1	30011103
SSS...	SSSCR 08CA-06	SC_0602__	8	10	0,4	32,4	28	17	6	9,5	4,5	25	3	30011104
	SSSCL 08CA-06	SC_0602__	8	10	0,4	32,4	28	17	6	9,5	4,5	25	3	30011105
	SSSCR 10CA-09	SC_09T3__	10	14	0,8	50,1	44	20	8	13	5	40	5	30011106

* patrz strony 660-661

Inne położenie ostrza, rozmiary i kąty przystawienia ostrzy dostępne na zapytanie.
 Zakres dostawy: Oprawka narzędziowa z zamontowanymi elementami. Płytki skrawające i osprzęt należy zamawiać oddzielnie.
 Wymiary podano w mm.

Oprawka narzędziowa ISO

Kształt T, Y

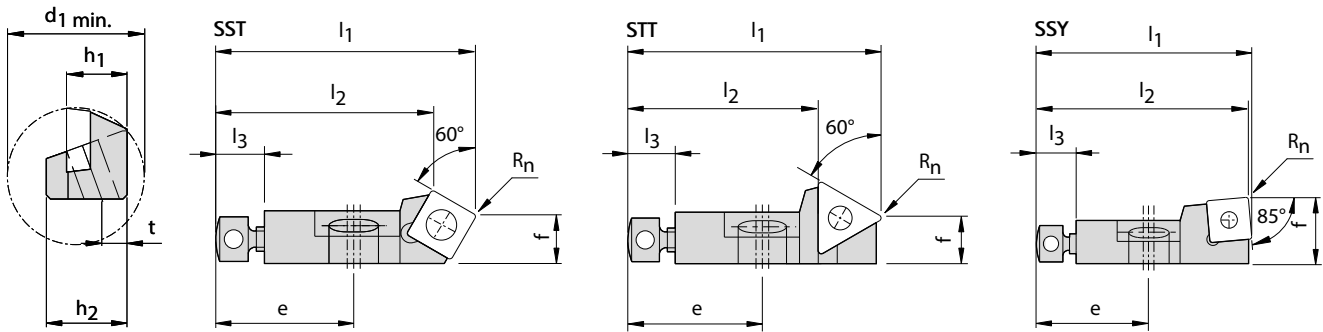

Rysunki narzędzi w wersji prawej – przykład SSTCR.

Magazynowa seria preferowana

	Specyfikacja	Odpowiednia płytka skrawająca	Wymiary										Grupa osprzętu *	Nr materiałowy
			h_1	f (w odniesieniu do R_n)	R_n	l_1	l_2	e	l_3	h_2	t	$d_1 \text{ min.}$		
SST...	SSTCR 10CA-09	SC_09T3__	10	13,3	0,8	50	40,6	20	8	13	5	40	5	30011118
	SSTCL 10CA-09	SC_09T3__	10	13,3	0,8	50	40,6	20	8	13	5	40	5	30011119
	SSTCR 12CA-12	SC_1204__	12	18,9	0,8	55	44,8	20	8	17	6	50	1	30011120
STT...	STTCR 08CA-09	TC_0902__	8	10,3	0,4	32	24,6	17	6	9,5	4,5	25	2	30011122
	STTCR 10CA-11-02	TC_1102__	10	14	0,4	50	41,4	20	8	13	5	40	4	30011124
SSY...	SSYCR 10CA-09	SC_09T3__	10	14	0,8	50,8	50	20	8	13	5	40	5	30011130
	SSYCR 12CA-12	SC_1204__	12	20	0,8	56	55	20	8	17	6	50	1	30011132

* patrz strony 660-661

Inne położenie ostrza, rozmiary i kąty przystawienia ostrzy dostępne na zapytanie.
 Zakres dostawy: Oprawka narzędziowa z zamontowanymi elementami. Płytki skrawające i osprzęt należy zamawiać oddzielnie.
 Wymiary podano w mm.

Kompaktowe oprawki narzędziowe

Kształt F

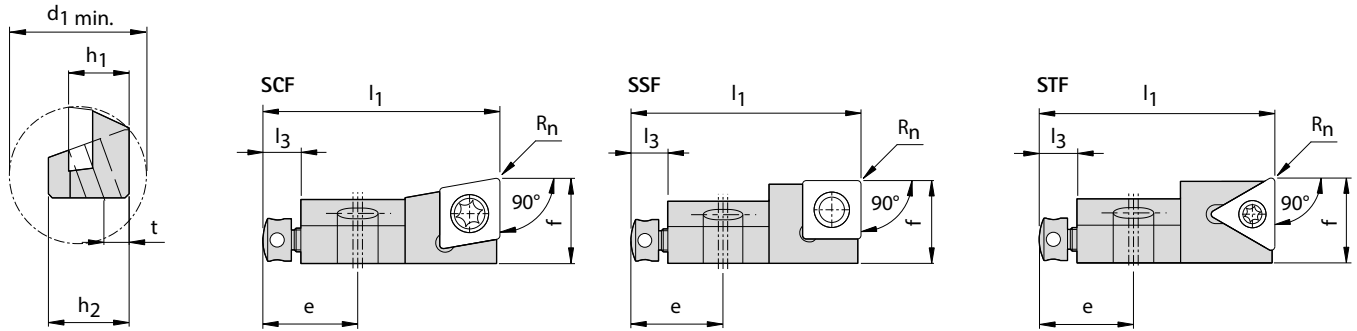

Rysunki narzędzi w wersji prawej – przykład SCFCR.

Magazynowa seria preferowana

	Specyfikacja	Odpowiednia płytka skrawająca	Wymiary									Grupa osprzętu *	Nr materiałowy
			h_1	f (w odniesieniu do R_n)	R_n	l_1	e	l_3	h_2	t	$d_1 \text{ min.}$		
SCF...	SCFCR 06CK-06 V1	CC_0602_	6	8,5	0,4	25	11	5	6	2,5	18	9	30011134
	SCFCL 06CK-06 V1	CC_0602_	6	8,5	0,4	25	11	5	6	2,5	18	9	30011135
	SCFCR 06CK-06 V2	CC_0602_	6	9,7	0,4	25	11	5	6	2,5	18	9	30011136
	SCFCR 10CK-09	CC_09T3_	10	14	0,8	40	17	8	15	5	33	14	30011138
	SCFCL 10CK-09	CC_09T3_	10	14	0,8	40	17	8	15	5	33	14	30011139
	SCFCR 12CK-12	CC_1204_	12	18	0,8	50	20	8	16	5	37	7	30011140
	SCFCL 12CK-12	CC_1204_	12	18	0,8	50	20	8	16	5	37	7	30011141
SSF...	SSFPR 08CK-06	SP_0603_	8	10	0,4	32	17	5	10	4,5	24	13	30011142
	SSFPR 10CK-09	SC_09T3_	10	14	0,8	44	17	8	15	5	33	16	30011144
	SSFPR 12CK-12	SC_1204_	12	18	0,8	50	20	8	16	5	37	7	30011146
	SSFCL 12CK-12	SC_1204_	12	18	0,8	50	20	8	16	5	37	7	30011147
STF...	STFCR 06CK-09	TC_0902_	6	10	0,4	25	11	5	6	2,5	18	17	30011148
	STFCR 10CK-11	TC_1102_	10	14	0,4	40	17	8	15	5	33	11	30011150
	STFCR 12CK-16	TC_16T3_	12	18	0,8	50	20	8	16	5	37	12	30011152

* patrz strony 660-661

Inne położenie ostrza, rozmiary i kąty przystawienia ostrzy dostępne na zapytanie.
 Zakres dostawy: Oprawka narzędziowa z zamontowanymi elementami. Płytki skrawające i osprzęt należy zamawiać oddzielnie.
 Wymiary podano w mm.

Kompaktowa oprawka narzędziowa

Kształt G, L

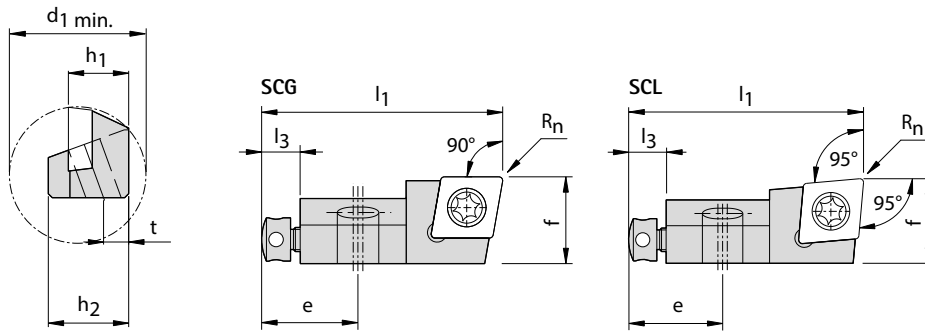

Rysunki narzędzi w wersji prawej – przykład SCGCR.

Magazynowa seria preferowana

	Specyfikacja	Odpowiednia płytka skrawająca	Wymiary									Grupa osprzętu *	Nr materiałowy
			h_1	f (w odniesieniu do R_n)	R_n	l_1	e	l_3	h_2	t	$d_1 \text{ min.}$		
SCG...	SCGCR 06CK-06 V1	CC_0602_	6	8,5	0,4	25	11	5	6	2,5	18	10	30011154
	SCGCL 06CK-06 V1	CC_0602_	6	8,5	0,4	25	11	5	6	2,5	18	10	30011155
	SCGCR 10CK-09	CC_09T3_	10	14	0,8	40	17	8	15	5	33	15	30011158
	SCGCL 10CK-09	CC_09T3_	10	14	0,8	40	17	8	15	5	33	15	30011159
	SCGCR 12CK-12	CC_1204_	12	18	0,8	50	20	8	16	5	37	8	30011160
	SCGCL 12CK-12	CC_1204_	12	18	0,8	50	20	8	16	5	37	8	30011161
SCL...	SCLCR 06CK-06 V1	CC_0602_	6	8,5	0,4	25	11	5	6	2,5	18	10	30011162
	SCLCL 06CK-06 V1	CC_0602_	6	8,5	0,4	25	11	5	6	2,5	18	10	30011163
	SCLCR 06CK-06 V2	CC_0602_	6	9,7	0,4	25	11	5	6	2,5	18	10	30011164
	SCLCL 06CK-06 V2	CC_0602_	6	9,7	0,4	25	11	5	6	2,5	18	10	30011165
	SCLCR 10CK-09	CC_09T3_	10	14	0,8	40	17	8	15	5	33	15	30011166
	SCLCL 10CK-09	CC_09T3_	10	14	0,8	40	17	8	15	5	33	15	30011167
	SCLCR 12CK-12	CC_1204_	12	18	0,8	50	20	8	16	5	37	7	30011168
	SCLCL 12CK-12	CC_1204_	12	18	0,8	50	20	8	16	5	37	7	30011169

* patrz strony 660-661

Inne położenie ostrza, rozmiary i kąty przystawienia ostrzy dostępne na zapytanie.
 Zakres dostawy: Oprawka narzędziowa z zamontowanymi elementami. Płytki skrawające i osprzęt należy zamawiać oddzielnie.
 Wymiary podano w mm.

Kompaktowa oprawka narzędziowa

Kształt R

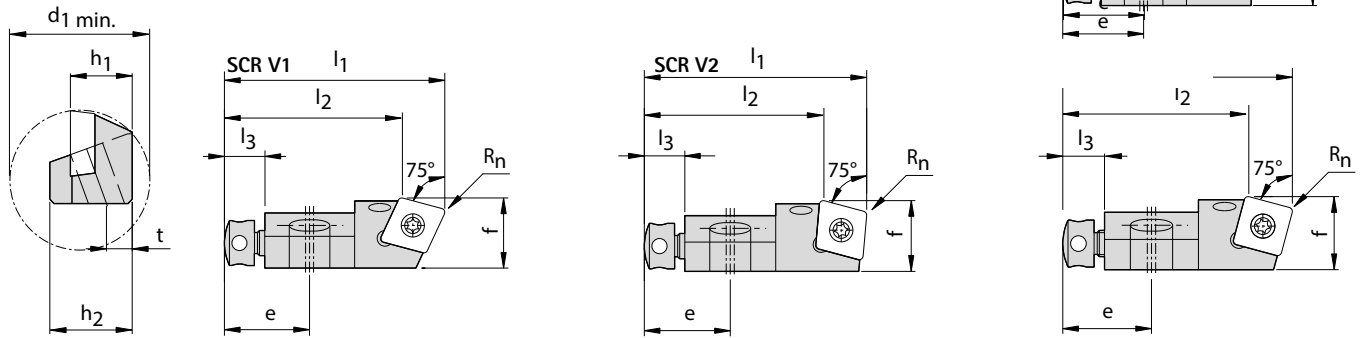

Rysunki narzędzi w wersji prawej – przykład SCRCR.

Magazynowa seria preferowana

	Specyfikacja	Odpowiednia płytka skrawająca	Wymiary										Grupa osprzętu *	Nr materiałowy
			h_1	f (w odniesieniu do R_n)	R_n	l_1	l_2	e	l_3	h_2	t	$d_1 \text{ min.}$		
SCR...V1	SCRCR 06CK-06 V1	CC_0602__	6	9,7	0,4	25	19,2	11	5	6	2,5	18	9	30011170
	SCRCR 10CK-09 V1	CC_09T3__	10	14	0,8	44	35,5	17	8	15	5	33	14	30011172
SCR...V2	SCRCR 06CK-06 V2	CC_0602__	6	10	0,4	25	19,2	11	5	6	2,5	18	9	30011174
	SCRCR 10CK-09 V2	CC_09T3__	10	14	0,8	44	35,5	17	8	15	5	33	16	30011176
SSR...V1	SSRPR 08CK-06	SP_0603__	8	10	0,4	32	26,3	17	5	10	4,5	24	13	30011178
	SSRCR 10CK-09	SC_09T3__	10	14	0,8	44	35,7	17	8	15	5	33	16	30011180
	SSRCL 10CK-09	SC_09T3__	10	14	0,8	44	35,7	17	8	15	5	33	16	30011181
	SSRCR 12CK-12	SC_1204__	12	18	0,8	50	38,6	20	8	16	5	37	7	30011182
STR...V1	STRCR 10CK-11	TC_1102__	10	14	0,4	40	30,4	17	8	15	5	33	11	30011186
	STRCR 12CK-16	TC_16T3__	12	18	0,8	50	36,1	20	8	16	5	37	12	30011188

* patrz strony 660-661

Inne położenie ostrza, rozmiary i kąty przystawienia ostrzy dostępne na zapytanie.
 Zakres dostawy: Oprawka narzędziowa z zamontowanymi elementami. Płytki skrawające i osprzęt należy zamawiać oddzielnie.
 Wymiary podano w mm.

Kompaktowa oprawka narzędziowa

Kształt S

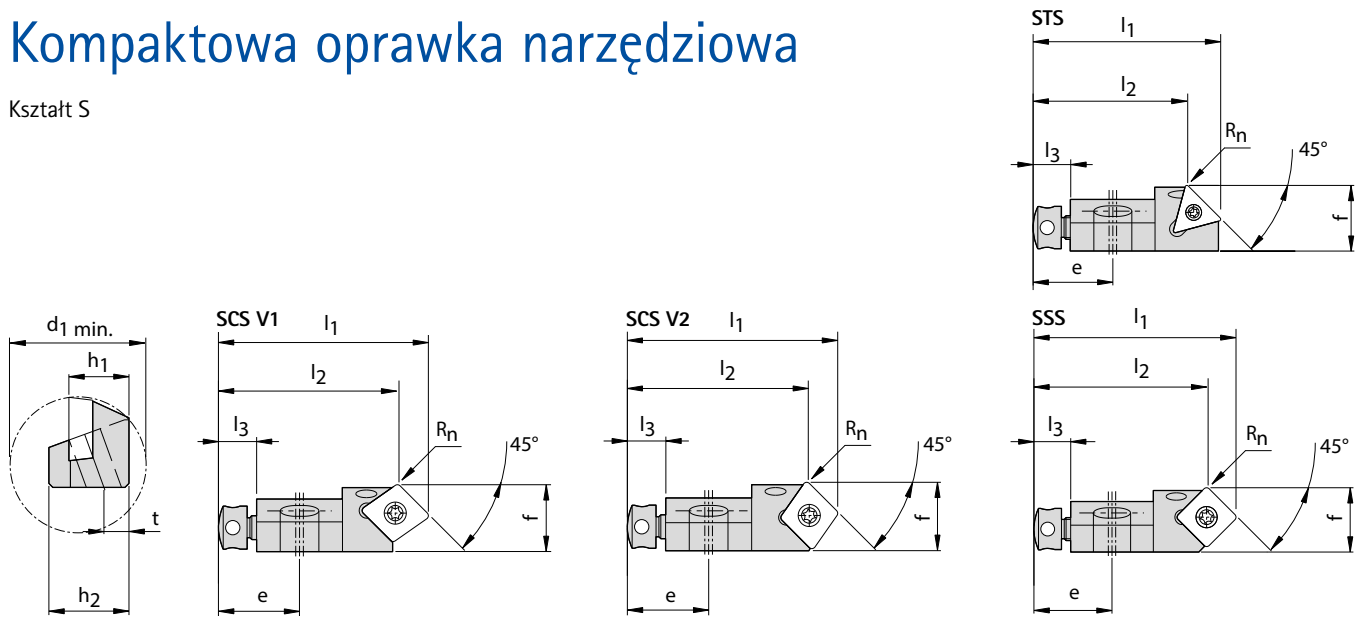

Rysunki narzędzi w wersji prawej – przykład SCSCR.

Magazynowa seria preferowana

	Specyfikacja	Odpowiednia płytka skrawająca	Wymiary										Grupa osprzętu *	Nr materiałowy
			h ₁	f (w odniesieniu do R _n)	R _n	l ₁	l ₂	e	l ₃	h ₂	t	d _{1 min.}		
SCS...V1	SCSCR 06CK-06 V1	CC_0602__	6	9,7	0,4	25	20,8	11	5	6	2,5	18	9	30011190
	SCSCR 10CK-09 V1	CC_09T3__	10	14	0,8	44	37,8	17	8	15	5	33	14	30011192
SCS...V2	SCSCR 06CK-06 V2	CC_0602__	6	10	0,4	25	20,8	11	5	6	2,5	18	9	30011194
	SCSCR 10CK-09 V2	CC_09T3__	10	14,3	0,8	44	37,8	17	8	15	5	33	14	30011196
SSS...	SSSPR 08CK-06	SP_0603__	8	10	0,4	32	27,8	17	5	10	4,5	24	13	30011198
	SSSPL 08CK-06	SP_0603__	8	10	0,4	32	27,8	17	5	10	4,5	24	13	30011199
	SSSCR 10CK-09	SC_09T3__	10	14	0,8	44	37,9	17	8	15	5	33	14	30011200
	SSSCL 10CK-09	SC_09T3__	10	14	0,8	44	37,9	17	8	15	5	33	14	30011201
	SSSCR 12CK-12	SC_1204__	12	18	0,8	50	41,7	20	8	16	5	37	7	30011202
STS...	STSCR 06CK-09	TC_0902__	6	10	0,4	25	18,9	11	5	6	2,5	18	17	30011204
	STSCR 10CK-11	TC_1102__	10	14	0,4	40	33	17	8	15	5	33	11	30011206

* patrz strony 660-661

Inne położenie ostrza, rozmiary i kąty przystawienia ostrzy dostępne na zapytanie.
 Zakres dostawy: Oprawka narzędziowa z zamontowanymi elementami. Płytki skrawające i osprzęt należy zamawiać oddzielnie.
 Wymiary podano w mm.

Kompaktowa oprawka narzędziowa

Kształt T

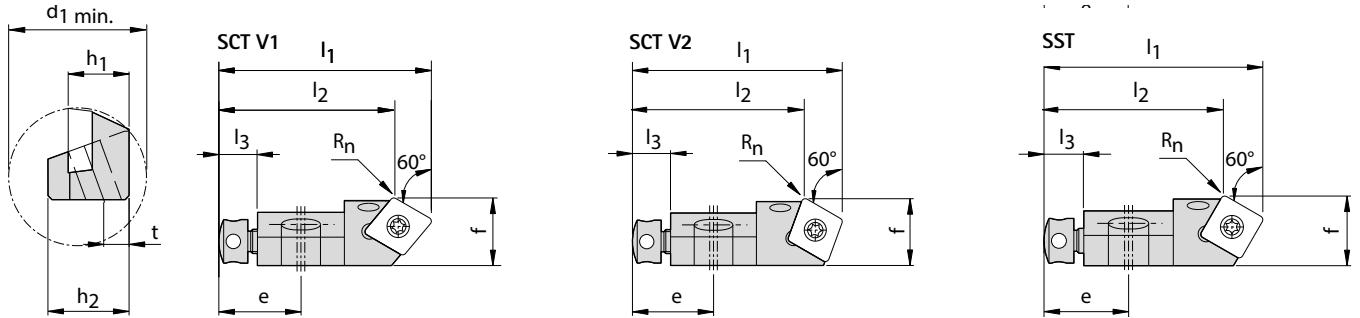

Rysunki narzędzi w wersji prawej – przykład SCTCR.

Magazynowa seria preferowana

	Specyfikacja	Odpowiednia płytka skrawająca	Wymiary										Grupa osprzętu*	Nr materiałowy
			h_1	f (w odniesieniu do R_n)	R_n	l_1	l_2	e	l_3	h_2	t	$d_1 \text{ min.}$		
SCT...V1	SCTCR 06CK-06 V1	CC_0602__	6	9,7	0,4	25	19,8	11	5	6	2,5	18	9	30011210
	SCTCR 10CK-09 V1	CC_09T3__	10	14	0,8	44	36,5	17	8	15	5	33	14	30011212
SCT...V2	SCTCR 06CK-06 V2	CC_0602__	6	10	0,4	25	19,8	11	5	6	2,5	18	9	30011214
	SCTCR 10CK-09 V2	CC_09T3__	10	14	0,8	44	36,5	17	8	15	5	33	16	30011216
SST...	SSTPR 08CK-06	SP_0603__	8	10	0,4	32	26,9	17	5	10	4,5	24	13	30011218
	SSTCR 10CK-09	SC_09T3__	10	14	0,8	44	36,6	17	8	15	5	33	14	30011220
	SSTCR 12CK-12	SC_1204__	12	18	0,8	50	39,8	20	8	16	5	37	7	30011222
ST...	STTCR 06CK-09	TC_0902__	6	10	0,4	25	17,6	11	5	6	2,5	18	17	30011224
	STTCR 10CK-11	TC_1102__	10	14	0,4	40	31,4	17	8	15	5	33	11	30011226
	STTCR 12CK-16	TC_16T3__	12	18	0,8	50	37,5	20	8	16	5	37	12	30011228

* patrz strony 660-661

Inne położenie ostrza, rozmiary i kąty przystawienia ostrzy dostępne na zapytanie.
 Zakres dostawy: Oprawka narzędziowa z zamontowanymi elementami. Płytki skrawające i osprzęt należy zamawiać oddzielnie.
 Wymiary podano w mm.

Kompaktowa oprawka narzędziowa

Kształt W, Y

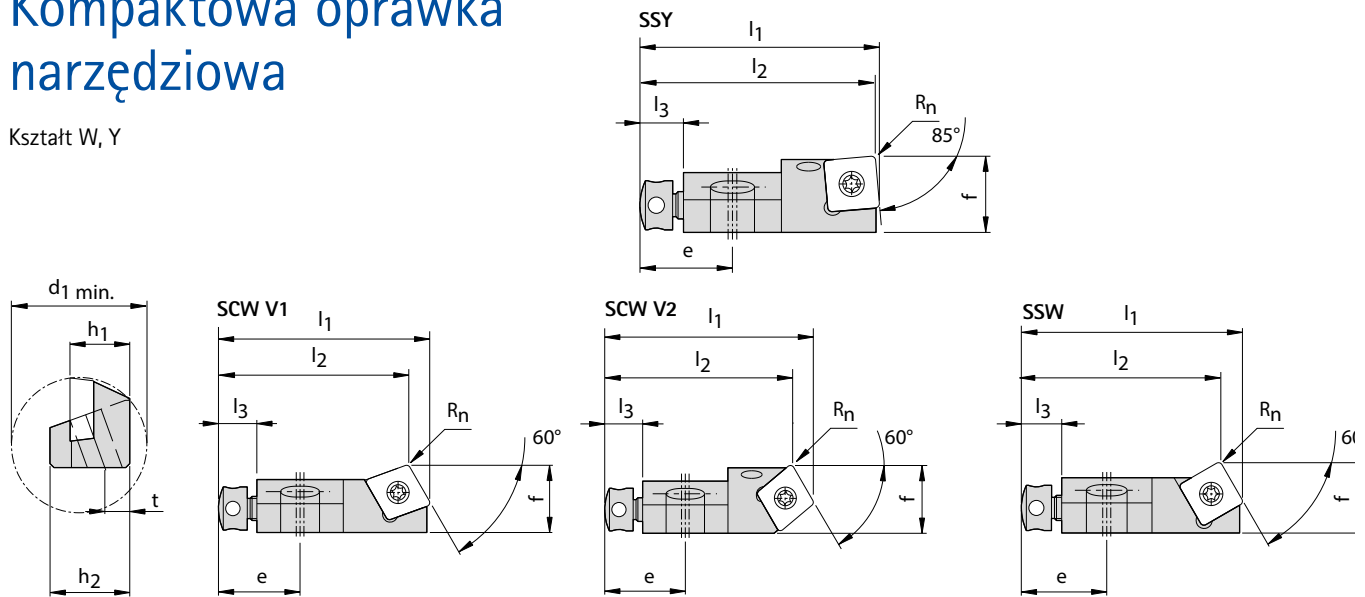

Rysunki narzędzi w wersji prawej – przykład SCWCR.

Magazynowa seria preferowana

	Specyfikacja	Odpowiednia płytka skrawająca	Wymiary										Grupa osprzętu *	Nr materiałowy
			h_1	f (w odniesieniu do R_n)	R_n	l_1	l_2	e	l_3	h_2	t	$d_1 \text{ min.}$		
SCW...V1	SCWCR 06CK-06 V1	CC__0602__	6	9,7	0,4	25	22	11	5	6	2,5	18	9	30011230
	SCWCR 10CK-09 V1	CC__09T3__	10	14	0,8	44	39,6	17	8	15	5	33	16	30011232
SCW...V2	SCWCL 06CK-06 V2	CC__0602__	6	10	0,4	25	22	11	5	6	2,5	18	9	30011235
SSW...:	SSWPR 08CK-06	SP__0603__	8	10	0,4	32	29,1	17	5	10	4,5	24	13	30011238
	SSWCL 10CK-09	SC__09T3__	10	14	0,8	44	39,7	17	8	15	5	33	16	30011241
	SSWCR 12CK-12	SC__1204__	12	18	0,8	50	44,1	20	8	16	5	37	7	30011242
	SSWCL 12CK-12	SC__1204__	12	18	0,8	50	44,1	20	8	16	5	37	7	30011243
SSY...:	SSYPR 08CK-06	SP__0603__	8	10	0,4	32	31,5	17	5	10	4,5	24	13	30011250
	SSYCR 10CK-09	SC__09T3__	10	14	0,8	44	43,2	17	8	15	5	33	16	30011252
	SSYCL 10CK-09	SC__09T3__	10	14	0,8	44	43,2	17	8	15	5	33	16	30011253
	SSYCR 12CK-12	SC__1204__	12	18	0,8	50	49	20	8	16	5	37	7	30011254

* patrz strony 660-661

Inne położenie ostrza, rozmiary i kąty przystawienia ostrzy dostępne na zapytanie.
 Zakres dostawy: Oprawka narzędziowa z zamontowanymi elementami. Płytki skrawające i osprzęt należy zamawiać oddzielnie.
 Wymiary podano w mm.

Kompaktowe oprawki narzędziowe na płytki skrawające styczne

Kształt F

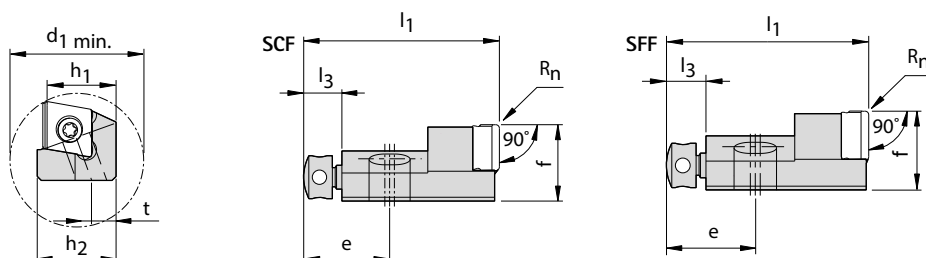

Rysunki narzędzi w wersji prawej – przykład SCFNR.

Magazynowa seria preferowana

	Specyfikacja	Odpowiednia płytki skrawająca	Wymiary										Grupa osprzętu *	Nr materiałowy
			h_1	f (w odniesieniu do R_n)	R_n	l_1	l_2	e	l_3	h_2	t	d_1 min.		
SCF...	SCFNR 10CT-06	CTHQ0604__	10	11	0,8	29	-	12	5	10,5	5	40	22	30305015
	SCFNR 14CT-09	CTHQ0905__	14	16	0,8	41	-	18	8	16	7	65	24	30305018
	SCFNR 18CT-12	CTHQ1206__	18	22	0,8	43	-	18	8	20	7	75	26	30305020
	SCFDR 10 CT-06	CTHD0603__	10	11	0,8	29	-	12	5	10,5	5	40	22	30552260
	SCFDR 14 CT-09	CTHD09T3__	14	16	0,8	41	-	18	8	16	7	65	20	30552263
	SCFDR 18 CT-12	CTHD1204__	18	22	0,8	43	-	18	8	20	7	75	18	30552264
SFF...	SFFNR 10CT-06	FTHQ0604__	10	11	0,8	29	-	12	5	10,5	5	35	22	30305022
	SFFNR 14CT-09	FTHQ0905__	14	16	0,8	41	-	18	8	16	7	44	24	30305024
	SFFNR 18CT-12	FTHQ1206__	18	22	0,8	43	-	18	8	20	7	59,5	26	30305026

* patrz strony 660-661

Inne położenie ostrza, rozmiary i kąty przystawienia ostrzy dostępne na zapytanie.
 Zakres dostawy: Oprawka narzędziowa z zamontowanymi elementami. Płytki skrawające i osprzęt należy zamawiać oddzielnie.
 Wymiary podano w mm.

Kompaktowe oprawki narzędziowe na płytki skrawające styczne

Kształt 80

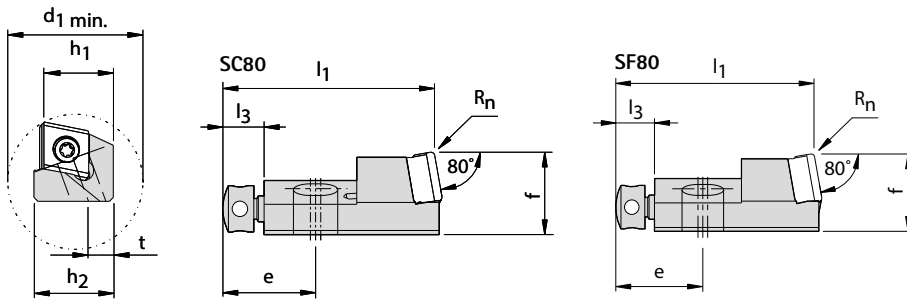

Rysunki narzędzi w wersji prawej – przykład SC80NR.

Magazynowa seria preferowana

	Specyfikacja	Odpowiednia płytki skrawająca	Wymiary										Grupa osprzętu *	Nr materiałowy
			h_1	f (w odniesieniu do R_n)	R_n	l_1	l_2	e	l_3	h_2	t	$d_1 \text{ min.}$		
SC80...	SC80NR 10CT-06	CTHQ0604__	10	11	0,8	29	-	12	5	10,5	5	40	23	30305016
	SC80NR 14CT-09	CTHQ0905__	14	16	0,8	41	-	18	8	16	7	65	25	30305019
	SC80NR 18CT-12	CTHQ1206__	18	22	0,8	43	-	18	8	20	7	75	27	30305021
SF80...	SF80NR 10CT-06	FTHQ0604__	10	11	0,8	29	-	12	5	10,5	5	35	23	30305023
	SF80NR 14CT-09	FTHQ0905__	14	16	0,8	41	-	18	8	16	7	44	25	30305025
	SF80NR 18CT-12	FTHQ1206__	18	22	0,8	43	-	18	8	20	7	59,5	27	30305027

* patrz strony 660-661

Inne położenie ostrza, rozmiary i kąty przystawienia ostrzy dostępne na zapytanie.
 Zakres dostawy: Oprawka narzędziowa z zamontowanymi elementami. Płytki skrawające i osprzęt należy zamawiać oddzielnie.
 Wymiary podano w mm.

Kompaktowe oprawki narzędziowe na płytki skrawające styczne

Kształt S, T, R

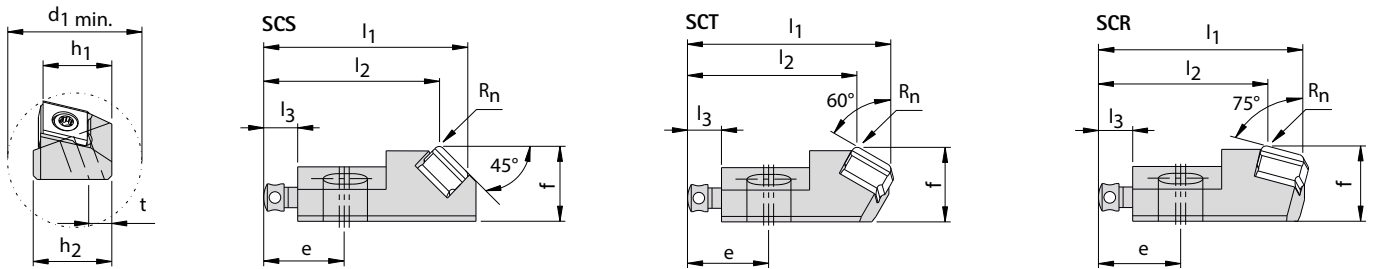

Rysunki narzędzi w wersji prawej – przykład SCSNR.

Magazynowa seria preferowana

Specyfikacja	Odpowiednia płytki skrawająca	Wymiary											Grupa osprzętu *	Nr materiałowy
		h_1	f (w odniesieniu do R_n)	R_n	l_1	l_2	e	l_3	h_2	t	d_1 min.			
SCS...	SCSNR 14 CT-09	CTHQ0905__	14	16	0,8	42,5	36	18	8	16	7	65	30	30552283
SCT...	SCTNR 10 CT-06	CTHQ0604__	10	11	0,8	30	24,7	12	5	10,5	5	40	22	30552284
	SCTNR 14 CT-09	CTHQ0905__	14	16	0,8	42,5	34,4	18	8	16	7	65	20	30552285
	SCTDR 10 CT-06	CTHD0603__	10	11	0,8	30	24,7	12	5	10,5	5	40	22	30552274
SCR...	SCRNR 14 CT-09	CTHQ0905__	14	16	0,8	42,5	33,3	18	8	16	7	65	20	30552287

* patrz strony 660-661

Inne położenie ostrza, rozmiary i kąty przystawienia ostrzy dostępne na zapytanie.
 Zakres dostawy: Oprawka narzędziowa z zamontowanymi elementami. Płytki skrawające i osprzęt należy zamawiać oddzielnie.
 Wymiary podano w mm.

Kompaktowe oprawki narzędziowe na płytki skrawające styczne

Kształt S, T, 20, R

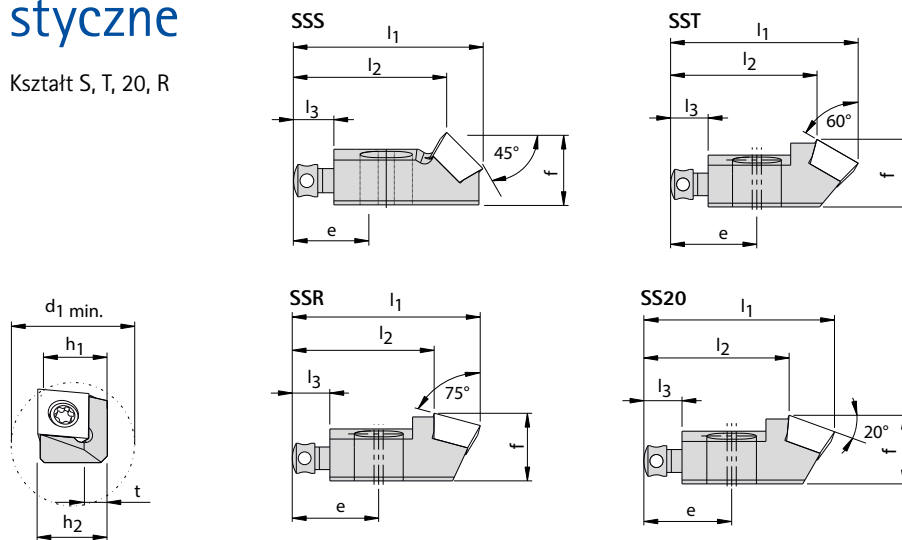

Rysunki narzędzi w wersji prawej – przykład SSSR.

Magazynowa seria preferowana

	Specyfikacja	Odpowiednia płytka skrawająca	Wymiary									Grupa osprzętu*	Nr materiałowy
			h ₁	f	l ₁	l ₂	e	l ₃	h ₂	t	d _{1 min.}		
SSS...	SSSSDR 08CT-06	STHD0603__	8,5	9	23,5	19	11,5	5	8,2	3,2	33	28	30474905
	SSSSDR 14CT-09	STHD09T3__	14	13,5	35,7	29	18	8	13,5	5	50	32	30474906
SST...	SSTDR 08 CT-06	STHD0603__	8,5	9	25	19,5	11,5	5	8,2	3,2	33	28	30552292
	SSTDR 14 CT-09	STHD09T3__	14	13,5	38	29,8	18	8	13,5	5	50	32	30552293
SS20...	SS20DR 08 CT-06	STHD0603__	8,5	9	25	19	11,5	5	8,2	3,2	33	28	30552294
	SS20DR 14 CT-09	STHD09T3__	14	13,5	38	29	18	8	13,5	5	50	32	30552295
SSR...	SSRDR 08 CT-06	STHD0603__	8,2	9	25	18,9	11,5	5	8,2	3,2	33	28	30552288
	SSRDR 14 CT-09	STHD09T3__	14	13,5	38	28,8	18	8	13,5	5	50	32	30552289

* patrz strony 660-661

Inne położenie ostrza, rozmiary i kąty przystawienia ostrzy dostępne na zapytanie.
 Zakres dostawy: Oprawka narzędziowa z zamontowanymi elementami. Płytki skrawające i osprzęt należy zamawiać oddzielnie.
 Wymiary podano w mm.

Osprzęt do opravek narzędziowych ISO i kompaktowych opravek narzędziowych

W wersji promieniowej i stycznej



Grupa osprzętu	Śruba mocująca do oprawy narzędziowej			Śruba regulacyjna osiowa		Śruba regulacyjna promieniowa		
	Symbol katalogowy Śruba z łbem walcowym	Moment dokręcania [Nm]*	Nr materia-łowy	Symbol katalogowy Śruba z łbem walcowym z rowkiem i otworami	Nr materia-łowy	Symbol katalogowy Trzpień gwintowany	Nr materia-łowy	
Oprawy narzędziowe ISO	1	DIN 7984 M6x20-10.9	12	10019671	M5 x 10	10029150	DIN 913 M4x10-45H	10003433
	2	DIN 7984 M4x12-10.9	3	10019695	M3 x 8	10002641	DIN 913 M3x6-45H	10003422
	3	DIN 7984 M4x12-10.9	3	10019695	M3 x 8	10002641	DIN 913 M3x6-45H	10003422
	4	DIN 7984 M6x16-10.9	12	10019703	M5 x 10	10029150	DIN 913 M4x8-45H	10003432
	5	DIN 7984 M6x16-10.9	12	10019703	M5 x 10	10029150	DIN 913 M4x8-45H	10003432
	6	DIN 7984 M6x20-10.9	12	10019671	M5 x 10	10029150	DIN 913 M4x10-45H	10003433
Kompaktowe oprawy narzędziowe	7	MN685 M6x25-TX25-IP	12	30606074	M5 x 7	10018493	DIN 915 M4x10-45H	10003900
	8	MN685 M6x25-TX25-IP	12	30606074	M5 x 7	10018493	DIN 915 M4x10-45H	10003900
	9	MN685 M3x10-TX9-IP	1,8	30606065	M3 x 5	10025039	DIN 915 M3x6-45H	10003894
	10	MN685 M3x10-TX9-IP	1,8	30606065	M3 x 5	10025039	DIN 915 M3x6-45H	10003894
	11	MN685 M6x20-TX25-IP	12	30606068	M5 x 7	10018493	DIN 915 M4x10-45H	10003900
	12	MN685 M6x25-TX25-IP	12	30606074	M5 x 7	10018493	DIN 915 M4x10-45H	10003900
	13	MN685 M4x14-TX15-IP	3	30606067	M3 x 5	10025039	DIN 915 M3x6-45H	10003894
	14	MN685 M6x20-TX25-IP	12	30606068	M5 x 7	10018493	DIN 915 M4x10-45H	10003900
	15	MN685 M6x20-TX25-IP	12	30606068	M5 x 7	10018493	DIN 915 M4x10-45H	10003900
	16	MN685 M6x20-TX25-IP	12	30606068	M5 x 7	10018493	DIN 915 M4x10-45H	10003900
	17	MN685 M3x10-TX9-IP	1,8	30606065	M3 x 5	10025039	DIN 915 M3x6-45H	10003894
Kompaktowe oprawy narzędziowe styczne	18	ISO 4762-M6X25-12.9	12	10003620	M5 x 7	10018493	ISO 4028-M4x10-45H-KL	30351530
	19	ISO 4762-M6X25-12.9	12	10003620	M5 x 7	10018493	ISO 4028-M4x10-45H-KL	30351530
	20	DIN 7984-M6X20-10.9	12	10019671	M5 x 7	10018493	ISO 4028-M4x10-45H-KL	30351530
	21	DIN 7984-M6X20-10.9	12	10019671	M5 x 7	10018493	ISO 4028-M4x10-45H-KL	30351530
	22	DIN 7984-M4X16-10.9	3	10019685	M3 x 5	10025039	ISO 4028-M3x6-45H-KL	30351529
	23	DIN 7984-M4X16-10.9	3	10019685	M3 x 5	10025039	ISO 4028-M3x6-45H-KL	30351529
	24	DIN 7984-M6X20-10.9	12	10019671	M5 x 7	10018493	ISO 4028-M4x10-45H-KL	30351530
	25	DIN 7984-M6X20-10.9	12	10019671	M5 x 7	10018493	ISO 4028-M4x10-45H-KL	30351530
	26	ISO 4762-M6X25-12.9	12	10003620	M5 x 7	10018493	ISO 4028-M4x10-45H-KL	30351530
	27	ISO 4762-M6X25-12.9	12	10003620	M5 x 7	10018493	ISO 4028-M4x10-45H-KL	30351530
	28	MN685 M4x14-TX15-IP	3	30606067	M3 x 5	10025039	-	-
	29	ISO 4762-M6X25-12.9	12	10003620	M5 x 7	10018493	-	-
	30	DIN 7984-M6X20-10.9	12	10019671	M5 x 7	10018493	ISO 4028-M4x10-45H-KL	30351530
	31	DIN 7984-M4X16-10.9	3	10019685	M3 x 5	10025039	ISO 4028-M3x6-45H-KL	30351529
	32	MN685 M6x20-TX25-IP	12	30606068	M5 x 7	10018493	-	-

* Momenty dokręcania wg MN678

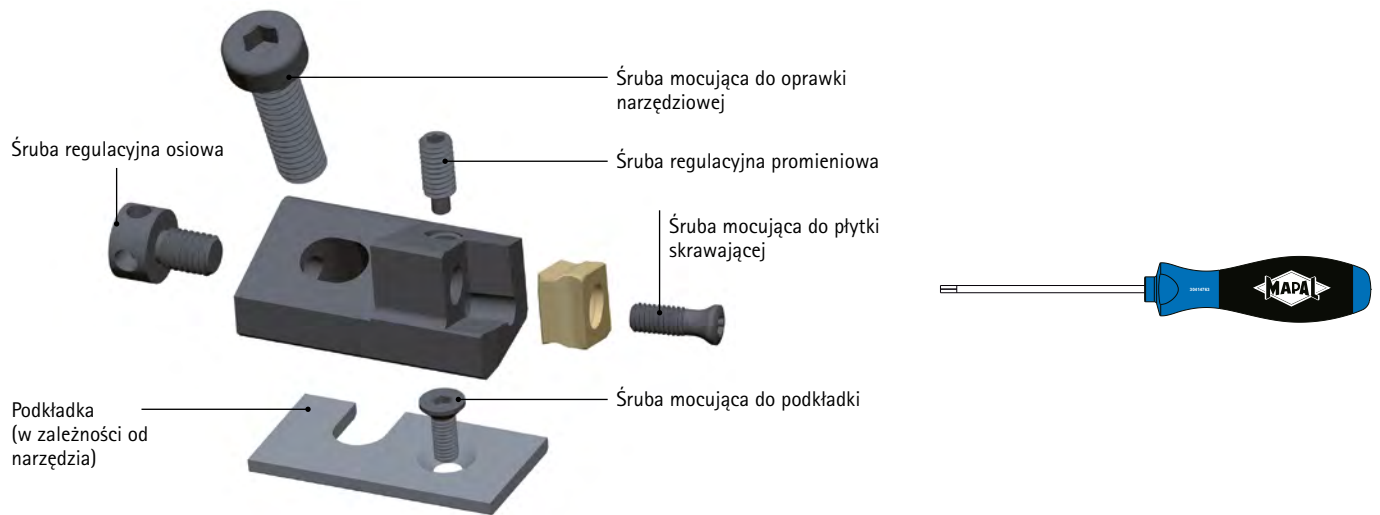

Podkładka prawa		Podkładka lewa		Śruba mocująca do podkładki		
Symbol katalogowy Podkładka	Nr materiałowy	Symbol katalogowy Podkładka	Nr materiałowy	Symbol katalogowy Śruba z łbem stożkowym	* Moment dokręcania [Nm]	Nr materiałowy
UR 12-1A	na zapytanie	UL 12-1A	na zapytanie	ISO 10642-M3X8-10.9	1,8	10003769
UR 08-1A	na zapytanie	UL 08-1A	na zapytanie	ISO 10642-M3X6-10.9	1,8	10003768
UR 08-1A	na zapytanie	UL 08-1A	na zapytanie	ISO 10642-M3X6-10.9	1,8	10003768
UR 10-1A	na zapytanie	UL 10-1A	na zapytanie	ISO 10642-M3X8-10.9	1,8	10003769
UR 10-1A	na zapytanie	UL 10-1A	na zapytanie	ISO 10642-M3X8-10.9	1,8	10003769
UR 12-1A	na zapytanie	UL 12-1A	na zapytanie	ISO 10642-M3X8-10.9	1,8	10003769
UR 12-1K	na zapytanie	UL 12-1K	na zapytanie	ISO 10642-M3X8-10.9	1,8	10003769
UR 12-2K	na zapytanie	UL 12-2K	na zapytanie	ISO 10642-M3X8-10.9	1,8	10003769
UR 06-1K	na zapytanie	UL 06-1K	na zapytanie	ISO 2009-M2X4-4.8	0,5	10029153
UR 06-2K	na zapytanie	UL 06-2K	na zapytanie	ISO 2009-M2X4-4.8	0,5	10029153
UR 10-1K	na zapytanie	UL101K	na zapytanie	ISO 10642-M3X8-10.9	1,8	10003769
UR 12-1K	na zapytanie	UL 12-1K	na zapytanie	ISO 10642-M3X8-10.9	1,8	10003769
UR 08-1K	na zapytanie	UL 08-1K	na zapytanie	ISO 10642-M3X6-10.9	1,8	10003768
UR 10-1K	na zapytanie	UL 10-1K	na zapytanie	ISO 10642-M3X8-10.9	1,8	10003769
UR 10-2K	na zapytanie	UL 10-2K	na zapytanie	ISO 10642-M3X8-10.9	1,8	10003769
UR 10-3K	na zapytanie	UL 10-3K	na zapytanie	ISO 10642-M3X8-10.9	1,8	10003769
UR 06-1K	na zapytanie	UL 06-1K	na zapytanie	ISO 2009-M2X4-4.8	0,5	10029153
UR 18-1T	na zapytanie	-	-	ISO 10642-M3X8-10.9	1,8	10003769
UR 18-4T	na zapytanie	-	-	ISO 10642-M3X8-10.9	1,8	10003769
UR 14-1T	na zapytanie	-	-	ISO 10642-M3X8-10.9	1,8	10003769
UR 14-4T	na zapytanie	-	-	ISO 10642-M3X8-10.9	1,8	10003769
UR 10-1T	na zapytanie	-	-	ISO 10642-M3X8-10.9	1,8	10003769
UR 10-2T	na zapytanie	-	-	ISO 10642-M3X8-10.9	1,8	10003769
UR 14-2T	na zapytanie	-	-	ISO 10642-M3X8-10.9	1,8	10003769
UR 14-3T	na zapytanie	-	-	ISO 10642-M3X8-10.9	1,8	10003769
UR 18-2T	na zapytanie	-	-	ISO 10642-M3X8-10.9	1,8	10003769
UR 18-3T	na zapytanie	-	-	ISO 10642-M3X8-10.9	1,8	10003769
-	-	-	-	-	-	-
-	-	-	-	-	-	-
UR 14-5T	na zapytanie	-	-	ISO 10642-M3X8-10.9	1,8	10003769
UR 10-3T	na zapytanie	-	-	ISO 10642-M3X8-10.9	1,8	10003769
-	-	-	-	-	-	-

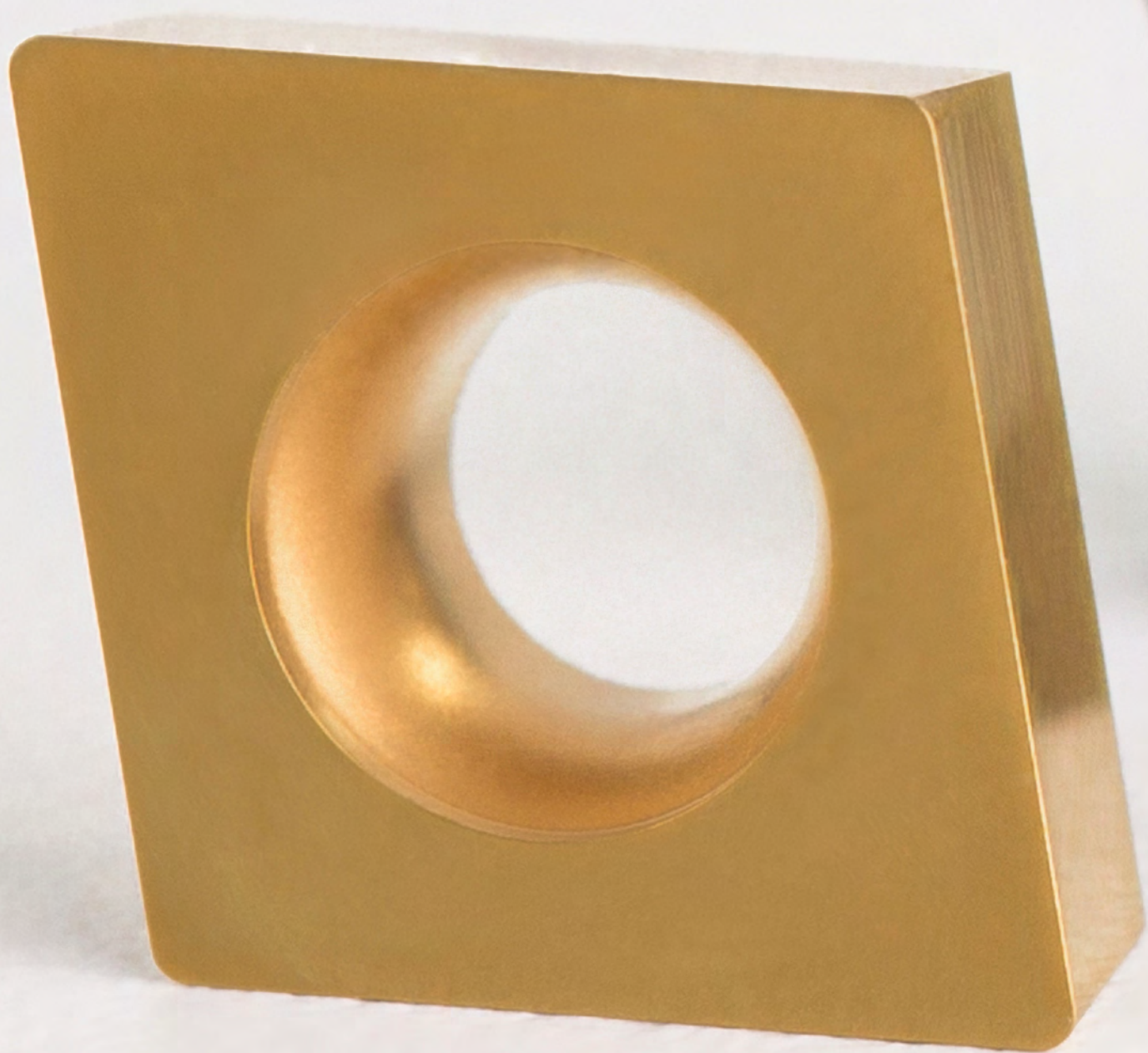

PŁYTKI SKRAWAJĄCE

Wstęp

Serie materiałów skrawających	664
Przegląd produktów	666
Przegląd materiałów skrawających	670
Oznaczenia	676
Przegląd łamaczy wiórów	680

Płytki skrawające

Płytki skrawające promieniowe	686
Płytki skrawające styczne	708
Osprzęt	730

Aneks techniczny

Zalecane parametry skrawania	732
------------------------------------	-----

Serie materiałów skrawających – odpowiedni materiał skrawający do każdego zastosowania

MAPAL oferuje szeroki asortyment płytek skrawających promieniowych i stycznych, który spełnia wszystkie wymagania dotyczące różnych materiałów skrawających i powłok, jak również odpowiednich geometrii ostrzy i dokładności.

Seria materiałów skrawających Performance Line

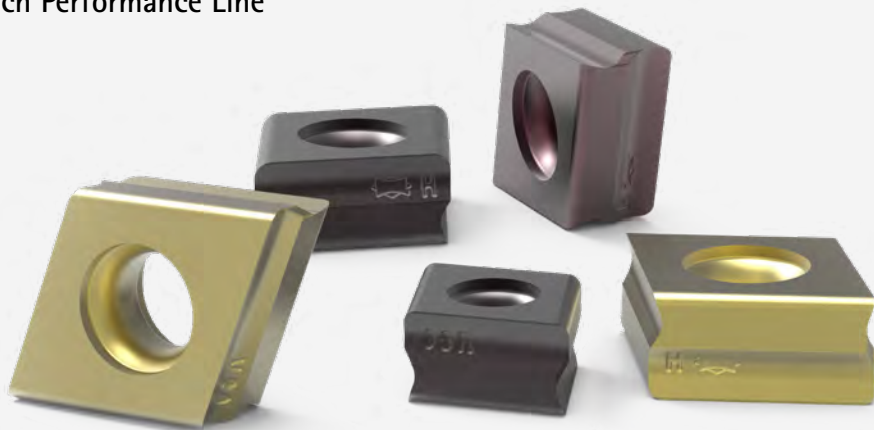

Seria materiałów skrawających Performance Line obejmuje szeroki asortyment płytek skrawających promieniowych i stycznych, który spełnia wszystkie wymagania dotyczące różnych materiałów skrawających i powłok, jak również odpowiednich geometrii ostrzy i dokładności.

Szlifowane, precyzyjne płytki skrawające o klasie tolerancji H umożliwiają faktyczne uzyskanie obróbki za pomocą kilku krawędzi skrawających także w przypadku narzędzi o stałych ostrzach. Wynika to z faktu, że w połączeniu z precyzyjnie wykonanymi gniazdami płytek, ostrza cechują się jedynie minimalnymi wzajemnymi odchyleniami. Oznacza to, że podczas obróbki wykorzystywane są jednocześnie wszystkie ostrza. Pozwala to na znaczne zwiększenie wydajności.

Płytki skrawające styczne spiekane w klasie tolerancji N uzupełniają ofertę o szczególnie ekonomiczne alternatywy, zwłaszcza w przypadku obróbki z większymi dopuszczalnymi tolerancjami. Nowością w programie są szlifowane obwodowo płytki skrawające promieniowe i styczne w klasie tolerancji G, stanowiące atrakcyjny cenowo zamiennik dla precyzyjnych płytek skrawających.

W SKRÓCIE

- Szeroka oferta płytek skrawających promieniowych i stycznych
- Asortyment obejmuje zarówno szlifowane, precyzyjne płytki skrawające w klasie tolerancji H, jak i płytki skrawające spiekane w klasie tolerancji N i G
- Duży wybór materiałów skrawających do niemal dowolnego obszaru zastosowań
- Warianty z ostrzami PCD i PcBN do bardzo ekonomicznej obróbki aluminium i żeliwa

Oznaczenia na wytłaczanych płytkach skrawających „press-to-size”



Seria materiałów skrawających Basic Line



Program Basic-Line obejmujący dodatkowo ostrza promieniowe do nawiercania i toczenia wyróżnia się doskonałym stosunkiem ceny do jakości. Do obróbki żeliwa, stali i stali nierdzewnej dostępne są materiały skrawające z powłoką CVD i PVD, które obejmują szeroki zakres między odpornością na zużycie a ciągliwością. Oznacza to, że możliwy jest dobór optymalnej płytki skrawającej do każdego zastosowania. W zależności od rodzaju obróbki dostępne są różne kształty podstawowe z różnymi łamaczami wiórów w klasach tolerancji M i G do obróbki zgrubnej, pośredniej i wykończeniowej.

W SKRÓCIE

- Dodatkowo ostrza promieniowe do nawiercania i toczenia
- Doskonały stosunek ceny do jakości
- Materiały skrawające z powłoką CVD i PVD do materiałów obrabianych z grup P, M i K
- Ostrza z cermetu zapewniające wysoką jakość powierzchni w przypadku obróbki stali
- Różne łamacze wiórów do obróbki zgrubnej, pośredniej i wykończeniowej

Seria materiałów skrawających do obróbki mieszanej

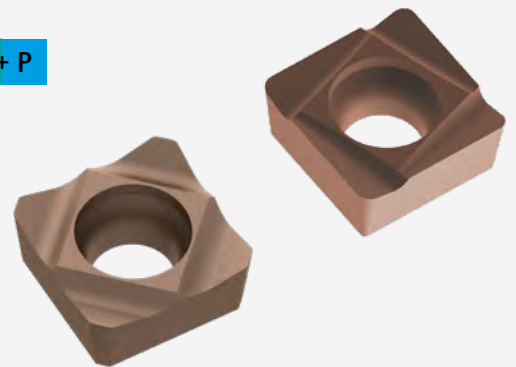

Kombinacje aluminium i stali spiekanej lub aluminium i żeliwa, stosowane do produkcji skrzyń korbowych, stawiają szczególne wymagania w zakresie obróbki skrawaniem. Do takich zadań obróbczych MAPAL oferuje specjalnie dostosowane serie materiałów skrawających. Zarówno podłoża węglkowe, jak i mikro- i makrogeometria ostrzy zostały opracowane specjalnie pod kątem obróbki mieszanej.









Powłoka PVD jako komponent wchodzący w skład serii materiałów skrawających zapobiega zarówno powstawaniu narostu podczas obróbki aluminium, jak i nadmiernemu zużyciu przy obróbce skrawaniem tych fragmentów obrabianych przedmiotów, które są wykonane z żeliwa lub stali spiekanej. Wynika to z faktu, że powłoka zapewnia szczególną odporność materiału skrawającego na zużycie i wysoką temperaturę. Dzięki temu możliwe jest uzyskanie najwyższej jakości obróbki.

W SKRÓCIE

- Materiał skrawający do obróbki kombinacji materiałów aluminium-żeliwo i aluminium-stal spiekana
- Odpowiednie podłoża z węgla spiekane, zoptymalizowana mikro- i makrogeometria ostrza, powłoka PVD na bazie stopu TiAlN ze specjalnym pierwiastkiem domieszkującym
- Dostępne standardowe i specjalne płytki skrawające ISO
- Duża wytrzymałość, a tym samym wysoka ekonomiczność narzędzi

Przegląd produktów – płytki skrawające 1/2

Promieniowa zabudowa płytki

Typ płytki	Promieniowa zabudowa płytki – Basic Line							
	CCMT	CCGT	DCMT	SCMT SPMT	SCGT	TCMT	VCMT	VCGT
								

Cechy

Liczba krawędzi skrawających	2	2	2	4	4	3	2	2
Wielkość płytki	06 / 09 / 12	06 / 09 / 12	07 / 11 / 15	06 / 09 / 12	09	09 / 11 / 16 / 22	16	11
Zakres średnicy	od 17 mm	od 17 mm		od 17 mm	od 25 mm	od 17 mm		
Kierunek skrawania	N	N	N	N	N	N	N	N
Nawiercanie – neutralny	■	■	■	■	■	■	■	■
Nawiercanie – szlif okrągły								
Pogłębianie / fazowanie								

Zastosowanie

Obróbka zgrubna	■		■	■		■	■	
Obróbka pośrednia	■	■	■	■		■	■	■
Obróbka wykończeniowa	■	■	■	■	■	■		

Materiał skrawający

Węgiel spiekany – szlifowany		■						■
Węgiel spiekany – wytłaczany	■		■	■		■	■	
Cermet		■	■		■	■	■	
PcBN								
PCD								

Grupa materiałowa

P	■	■	■	■	■	■	■	■
M ₁	■	■	■	■		■		■
M ₂	■	■	■	■		■		■
K	■		■	■		■	■	
N								
N K								
N P								

Strona	686	688	692	694	694	700	704	704
--------	-----	-----	-----	-----	-----	-----	-----	-----

Przegląd produktów – płytki skrawające 2/2

Styczna zabudowa płytki

Typ płytki	Promieniowa zabudowa płytki – Performance Line							
	CCGT	CCGW	DCGT	DCGW	SCGT SPGT	SCGW SPGW	TCGW	VBGW VCGW
								

Cechy

Liczba krawędzi skrawających	1	1	1	1	1	1	1	1
Wielkość płytki	06 / 09	06 / 09	11	11	06 / 09	06 / 09 / 12	11	16
Zakres średnicy	od 17 mm	od 17 mm			od 17 mm	od 17 mm	od 17 mm	
Kierunek skrawania	N	N	N	N	L / P / N	N	N	N
Nawiercanie – neutralny	■	■	■	■	■	■	■	■
Nawiercanie – szlif okrągły								
Pogłębianie / fazowanie								

Zastosowanie

Obróbka zgrubna								
Obróbka pośrednia	■	■	■			■	■	
Obróbka wykończeniowa	■	■	■	■	■	■	■	■









Materiał skrawający

Węglik spiekany – szlifowany								
Węglik spiekany – wytłaczany								
Cermet								
PcBN		■		■		■	■	■
PCD	■	■	■	■	■	■	■	

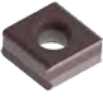
Grupa materiałowa

P								
M ₁								
M ₂								
K		■		■		■	■	■
N	■	■	■	■	■	■	■	
N K								
N P								

Strona	688	689	692	692	694	696	700	704
--------	-----	-----	-----	-----	-----	-----	-----	-----

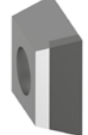
Styczna zabudowa płytki – Performance Line									
CTNQ	CTGQ	CTHQ		FTNQ	FTGQ	FTHQ		STHD / STHE	
									
4	4	4	1	4	4	4	1	4	1
09 / 12	09 / 12	06 / 09 / 12	06 / 09 / 12	09 / 12	09 / 12	06 / 09 / 12	06 / 09 / 12	06 / 09	06 / 09
od 41 mm	od 65 mm	od 28 mm	od 28 mm	od 30 mm	od 30 mm	od 22 mm	od 22 mm		
L / P	L	L / P	L / P	L / P	L	L / P	L / P	N	N
■		■	■	■		■	■		
	■	■	■		■	■	■		
								■	■
■	■	■	■	■	■	■	■		
■	■	■	■	■	■	■	■		
■		■			■	■		■	
	■			■					
			■				■		■
■	■	■		■	■	■			
■	■	■		■		■			
■	■	■		■		■		■	
■		■		■	■	■		■	
		■	■			■	■	■	■
708	710	712	712	718	720	722	722	728	728

Przegląd materiałów skrawających: wybór właściwego materiału skrawającego

Wybór materiału skrawającego

Dostępne materiały skrawające obejmują szeroki zakres właściwości pomiędzy odpornością na zużycie a ciągliwością. Oznaczenie materiału skrawającego jest skonstruowane w taki sposób, że wraz ze wzrostem liczby wzrasta jego ciągliwość.

Materiały skrawające pokryte powłoką CVD (HC...) to pierwszy wybór w przypadku nawiercania materiałów obrabianych z grup K, P i M. Osiągają one najdłuższą wytrzymałość.

Przykład: HC830 jest bardziej ciągliwy niż HC815 (im większa ciągliwość materiału skrawającego, tym słabsza wytrzymałość na zużycie).

W przypadku obrabianych materiałów nieżelaznych pierwszym wyborem są gatunki węglików spiekanych bez powłoki i z powłoką PCD (HU.../HP...). Od zawartości krzemu $\geq 12\%$ zaleca się stosowanie PCD (PU...) ze względu na rosnącą ścieralność. Dzięki PCD można

osiągnąć największą wytrzymałość narzędzi, dlatego ten materiał skrawający jest szczególnie odpowiedni do produkcji wielkoseryjnej.

1. Proszę wybrać obrabiany materiał wg MZG (klasyfikacji grup materiałowych MAPAL – patrz rozkładówka na końcu katalogu).

2. W zależności od linii produktów proszę wybrać z odpowiedniej **tabeli „Przegląd materiałów skrawających [...]”** gatunek znajdujący się poniżej wybranego materiału obrabianego.

3. Zależnie od warunków brzegowych (patrz **tabela „Warunki brzegowe”**) proszę wybrać materiał skrawający odporny na zużycie lub bardziej ciągliwy z powłoką CVD.

4. Jeżeli warunki brzegowe są zgodne z kierunkiem czarnych strzałek i pomimo zastosowania ciągliwego gatunku CVD nie można zapobiec powstawaniu pęknięć, należy przejść na materiały skrawające z powłoką PVD.

Warunki brzegowe

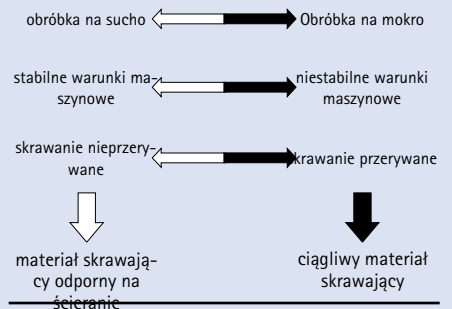

Przegląd materiałów skrawających – Basic Line

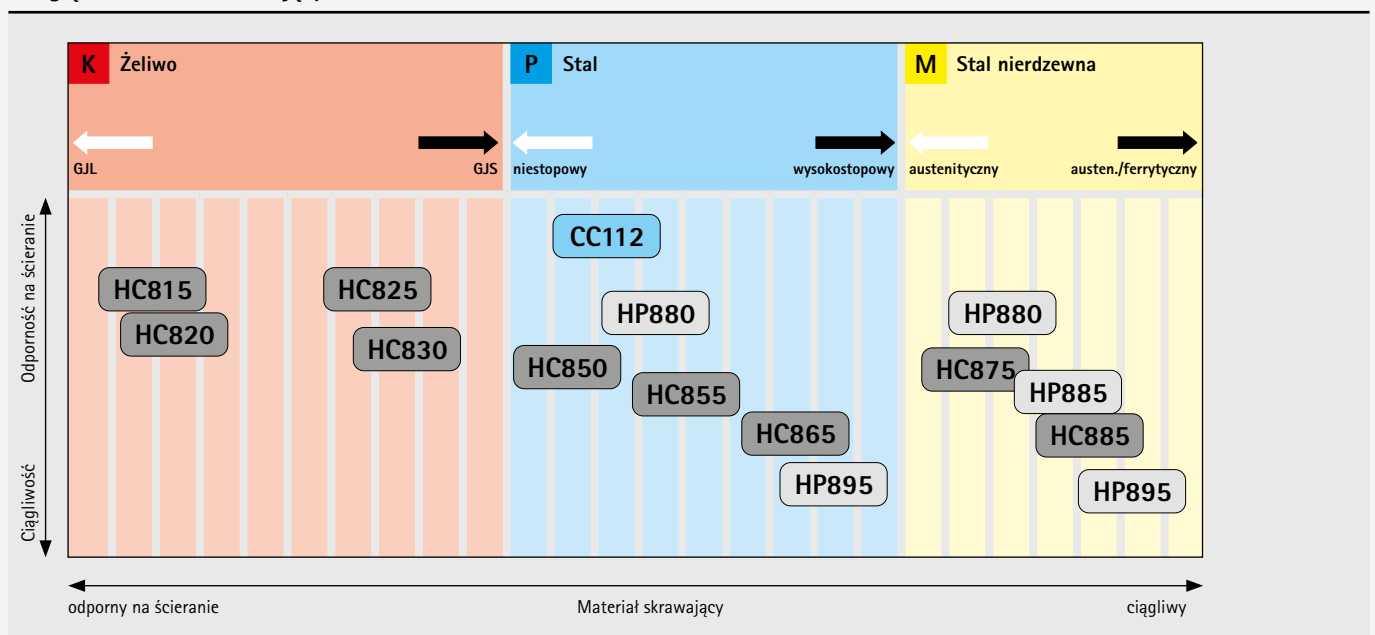

CVD

PVD

Cermet, CVD

Wybór materiału skrawającego

1. Proszę wybrać z tabeli „Przegląd materiałów skrawających” gatunek, znajdujący się poniżej wybranego materiału obrabianego.
2. Do obróbki mieszanej żeliwa z aluminium pierwszym wyborem jest gatunek HP530-P, a w przypadku kombinacji aluminium-stal – gatunek HP545-P.
3. Jeśli zapewniony jest stabilny proces z normalnym zużyciem, dla zapewnienia większej wytrzymałości można wybrać bardziej odporny na zużycie gatunek HP525-P do obróbki kombinacji żeliwo-aluminium lub HP540-P do obróbki kombinacji stal-aluminium.

Przegląd materiałów skrawających – obróbka mieszana

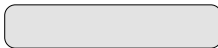
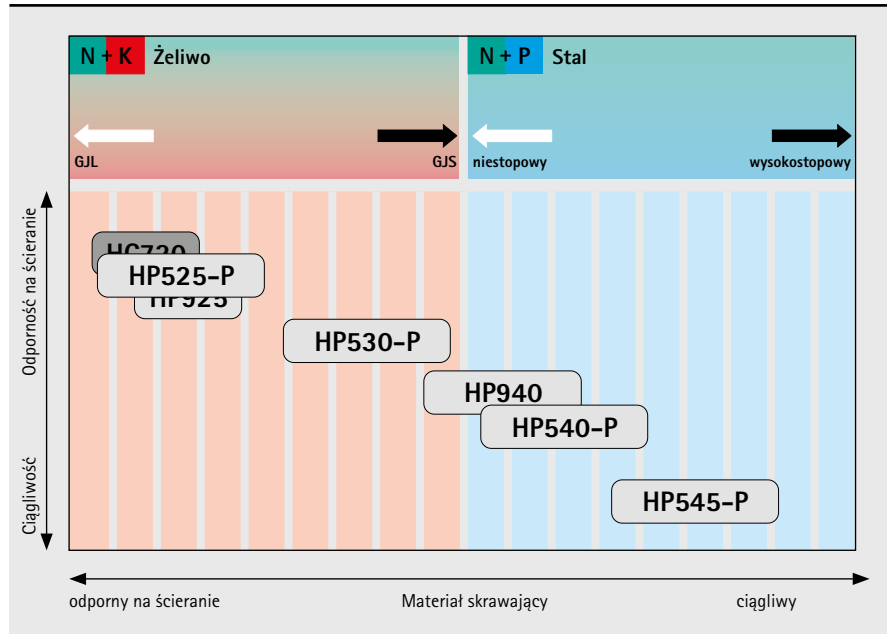

Przegląd materiałów skrawających – Performance Line

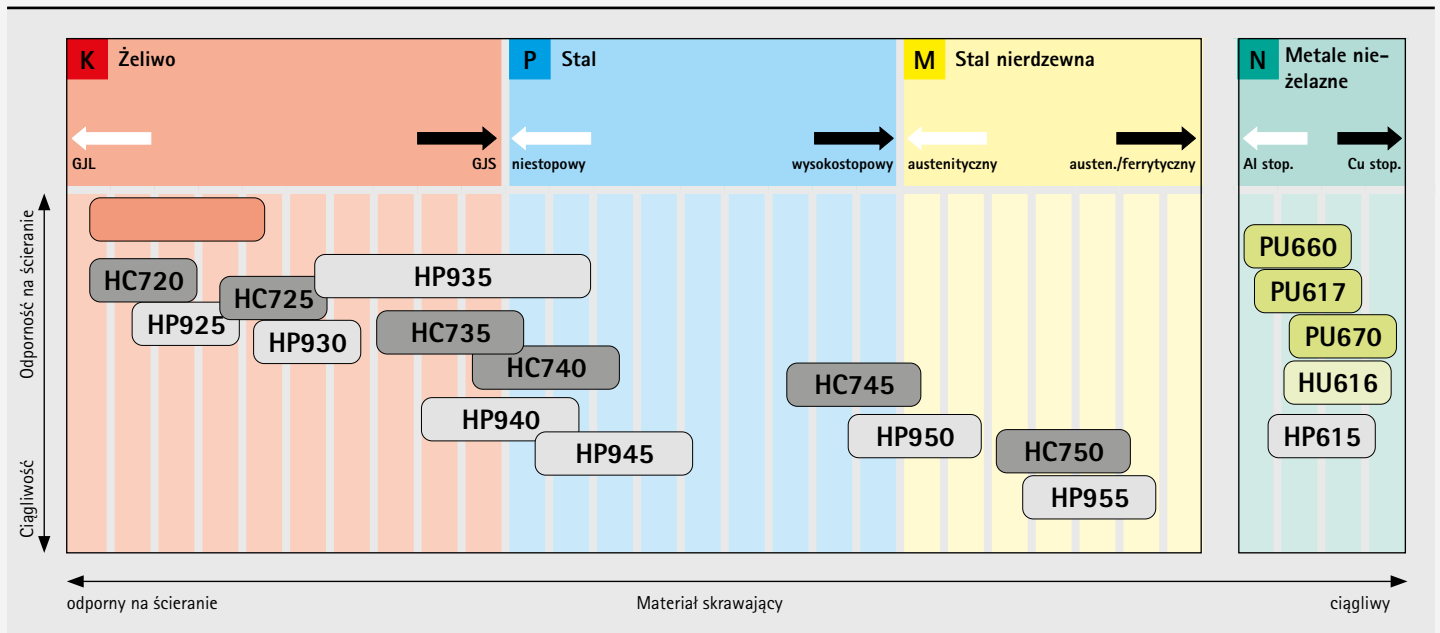

- CVD
- PVD
- PcBN
- PCD
- bez powłoki

Przegląd materiałów skrawających: Rodzaje i charakterystyka 1/2

Podłoże	Powłoka	Materiał skrawający	Skład warstwowy	Kolor warstwowy	Zakres zastosowania	Zalecane zastosowanie
cermet	z powłoką CVD	CC112	TiCN+Al ₂ O ₃	kolorowa	●	Najbardziej drobnoziarnisty gatunek cermetu z powłoką Al ₂ O ₃ do obróbki wykończeniowej i pośredniej materiałów stalowych i żeliwnych przy podwyższonych prędkościach skrawania.
PcBN	bez powłoki	FU430	-	-	●	Gatunek PcBN o wysokiej zawartości CBN do obróbki wykończeniowej i półwykończeniowej GJL i metali spiekanych.
Węgiel spiekany	z powłoką CVD	HC698*	diament	czarno-antracytowy	●	Węgiel spiekany z powłoką diamentową CVD do obróbki aluminium.
		HC725	TiCN+Al ₂ O ₃	czarny	●	Drobnoziarnisty węgiel spiekany o wysokiej odporności na zużycie i wielowarstwowej powłoce CVD z warstwą wierzchnią z Al ₂ O ₃ do obróbki GJL i GJS przy wysokich prędkościach skrawania. Do skrawania ciągłego do lekko przerywanego podczas obróbki pośredniej do zgrubnej.
		HC740	TiCN+Al ₂ O ₃	czarny	●	Drobnoziarnisty węgiel spiekany o wysokiej odporności na zużycie i wielowarstwowej powłoce CVD z warstwą wierzchnią z Al ₂ O ₃ . Do skrawania ciągłego do lekko przerywanego podczas obróbki pośredniej do zgrubnej GJS, stali nierdzewnych i stali żaroodpornych.
		HC745	TiCN+Al ₂ O ₃	czarny	↔	Drobnoziarnisty węgiel spiekany o zrównoważonym stosunku zużycia do ciągliwości oraz wielowarstwowej powłoce CVD z warstwą wierzchnią z Al ₂ O ₃ do obróbki przy wyższych prędkościach skrawania. Do skrawania przerywanego lub niestabilnych warunków i materiałów obrabianych o podwyższonej wytrzymałości na rozciąganie oraz stali wysokostopowych po nierdzewne, jak również stali żaroodpornych.
		HC750	TiCN+Al ₂ O ₃	czarny	↔	Drobnoziarnisty węgiel spiekany o zrównoważonym stosunku ciągliwości oraz wielowarstwowej powłoce CVD z warstwą wierzchnią z Al ₂ O ₃ . Do skrawania przerywanego lub niestabilnych warunków i materiałów obrabianych o najwyższej wytrzymałości na rozciąganie, stali nierdzewnych po staliwa żaroodporne.
		HC815	TiCN+Al ₂ O ₃	czarny	●	Odporny na zużycie gatunek drobnoziarnistego węgla spiekane z powłoką z Al ₂ O ₃ . Odpowiedni do obróbki materiałów żeliwnych w stabilnych warunkach.
		HC820	TiCN+Al ₂ O ₃	czarny	●	Węgiel spiekany z powłoką z Al ₂ O ₃ ze zoptymalizowaną obróbką końcową w celu zwiększenia stabilności krawędzi. Odpowiedni do obróbki GJL w stabilnych warunkach i do skrawania lekko przerywanego.
		HC825	TiCN+Al ₂ O ₃	czarny	●	Podwyższona odporność na zużycie dzięki grubej powłoce CVD. Odpowiedni do obróbki żeliwa w niestabilnych warunkach.
		HC830	TiCN+Al ₂ O ₃	czarny	●	Drobnoziarnisty gatunek węgla spiekane z grubą powłoką i lepszą stabilnością krawędzi. Odpowiedni do skrawania mocno przerywanego podczas obróbki żeliwa.
		HC850	TiCN+Al ₂ O ₃ +TiN	złoty	●	Węgiel gradientowy z powłoką z MT-TiCN i Al ₂ O ₃ i warstwą wierzchnią z TiN. Odpowiedni do obróbki stali ze względu na zmniejszoną chropowatość powierzchni.
		HC855	TiCN+Al ₂ O ₃ +TiN	złoty	●	Węgiel gradientowy o zrównoważonym stosunku ciągliwości do odporności na zużycie. Odpowiedni do obróbki półwykończeniowej i pośredniej stali.
		HC865	TiCN+Al ₂ O ₃ +TiN	złoty	↔	Ciągliwy gatunek węgla gradientowego z powłoką z Al ₂ O ₃ i gładką warstwą wierzchnią z TiN. Odpowiedni do obróbki półwykończeniowej i pośredniej stali i stali stopowej.
		HC875	TiCN+Al ₂ O ₃ +TiN	złoty	●	Drobnoziarnisty gatunek węgla gradientowego z cienką powłoką PVD. Odpowiedni do obróbki stali wysokostopowej i nierdzewnej.
		HC885	TiCN+Al ₂ O ₃ +TiN	złoty	↔	Gatunek węgla spiekane o podwyższonej ciągliwości z powłoką CVD. Odpowiedni do obróbki stali nierdzewnej.

* Materiał skrawający do wiercenia w pełnym aluminium.

Przegląd materiałów skrawających: Rodzaje i charakterystyka 2/2

Podłoże	Powłoka	Materiał skrawający	Skład warstwy	Kolor warstwy	Zakres zastosowania	Zalecane zastosowanie	
Węgiel spiekany	z powłoką PVD	HP615	TiB2	antracytowy	●	Drobnoziarnisty węgiel spiekany z częściowo zredukowaną warstwą PVD do obróbki materiałów przyczepnych. Pierwszy wybór w celu wydłużenia wytrzymałości narzędzia w porównaniu z niepowlekanymi ostrzami w przypadku stopów aluminium o zawartości 7-12% krzemu.	
		HP880	TiAlN	antracytowy	●	Doskonała odporność na zużycie i odporność na wysokie temperatury dzięki nowej powłoce PVD. Odpowiedni do obróbki wykończeniowej stali nierdzewnej.	
		HP885	TiAlN + TiAlSiN	Miedź	●	Odporny na temperaturę rodzaj materiału skrawającego, drobnoziarnisty węgiel spiekany z wielowarstwową powłoką PVD do uniwersalnej obróbki stali nierdzewnych.	
		HP895	TiAlN	antracytowy	↔	Najbardziej drobnoziarnisty węgiel spiekany z powłoką TiAlN o dużej zawartości spoiwa. Optymalne połączenie odporności na zużycie i ciągliwości. Odpowiedni do obróbki półwykończeniowej stali nierdzewnej.	
		HP930	AlTiCrN	czarno-antracytowy	●	Drobnoziarnisty węgiel spiekany z grubowarstwową powłoką PVD. Gatunek do obróbki półzgrubnej i zgrubnej GJL i GJS.	
		HP945	AlTiCrN	czarno-antracytowy	↔	Drobnoziarnisty węgiel spiekany z grubowarstwową powłoką PVD. Do nawiercania stali i stali nierdzewnych oraz stali żaroodpornych.	
		HP950	TiAlSiN	Miedź	↔	Ciągliwy drobnoziarnisty węgiel spiekany z warstwą PVD. Do nawiercania materiałów obrabianych o najwyższej wytrzymałości na rozciąganie, stali nierdzewnych po staliwa żaroodporne.	
	z powłoką CVD, obróbka mieszana	HP525-P	TiAlXN	złoto-brązowy	●	Węgiel spiekany z powłoką PVD, szczególnie odpowiedni do obróbki mieszanej aluminium i GJL/GJS przy skrawaniu ciągłym.	
		HP530-P	TiAlXN	złoto-brązowy	●	Węgiel spiekany z powłoką PVD, szczególnie odpowiedni do obróbki mieszanej aluminium i GJL/GJS przy skrawaniu ciągłym do lekko przerywanego.	
		HP540-P	TiAlXN	złoto-brązowy	●	Węgiel spiekany z powłoką PVD, szczególnie odpowiedni do obróbki mieszanej aluminium i stali spiekanej przy skrawaniu ciągłym do lekko przerywanego.	
		HP545-P	TiAlXN	złoto-brązowy	●	Węgiel spiekany z powłoką PVD o zrównoważonym stosunku ciągliwości, szczególnie odpowiedni do obróbki mieszanej aluminium i stali spiekanej przy skrawaniu lekko przerywanym do mocno przerywanego.	
	PCD	I	PU617	-	-	●	Gatunek PCD o średniej wielkości ziarna do obróbki zgrubnej do pośredniej metali nieżelaznych oraz do obróbki materiałów o bardzo dużej ścieralności.
			PU660	-	-	●	Drobnoziarnisty gatunek PCD do obróbki wykończeniowej metali nieżelaznych oraz obrabianych materiałów niemetalicznych, takich jak tworzywa sztuczne wzmocnione włóknem. Drobne ziarno nadaje ostrzom dobrą ostrość (ciernistość) przy wysokiej odporności na zużycie, co pozwala na uzyskanie wysokiej jakości wykończenia powierzchni.
			PU670	-	-	↔	Materiał skrawający PCD o średniej do dużej wielkości ziarna. Doskonała odporność na zużycie mechaniczne z dobrą ciągliwością, szczególnie odpowiedni do obróbki materiałów ścieralnych.

Oznaczenia – płytki skrawające promieniowe

		S	C	H	T	O	9	T	3					
		Tolerancja			Typ płytki		Wielkość płytki							
Kształt płytki	S (90°)							Okrąg wewnętrzny						
	C (80°)	d [mm]	m [mm]	s [mm]				d [mm]	S	C	T	D	V	
	T (60°)	H	±0,013	±0,013	±0,025				5,56	-	-	09	-	-
	D (55°)	G	±0,025	±0,025	±0,05 do ±0,13 *				6,35	06	06	11	07	11
	V (35°)	M	±0,05 do ±0,15 *	±0,08 do ±0,20 *	±0,05 do ±0,13 *				6,70	-	-	-	-	-
	W (82°)**								9,525	09	09	16	11	16
									12,70	12	12	22	-	-

Kąt przystawienia

B	5°
C	7°
P	11°
O	Kształt specjalny

Grubość płytki

Wskaźnik	s [mm]
T1	1,98
02	2,38
03	3,18
T3	3,97
04	4,76

* Tolerancja zależnie od wielkości płytki

** Wiercenie w pełnym materiale

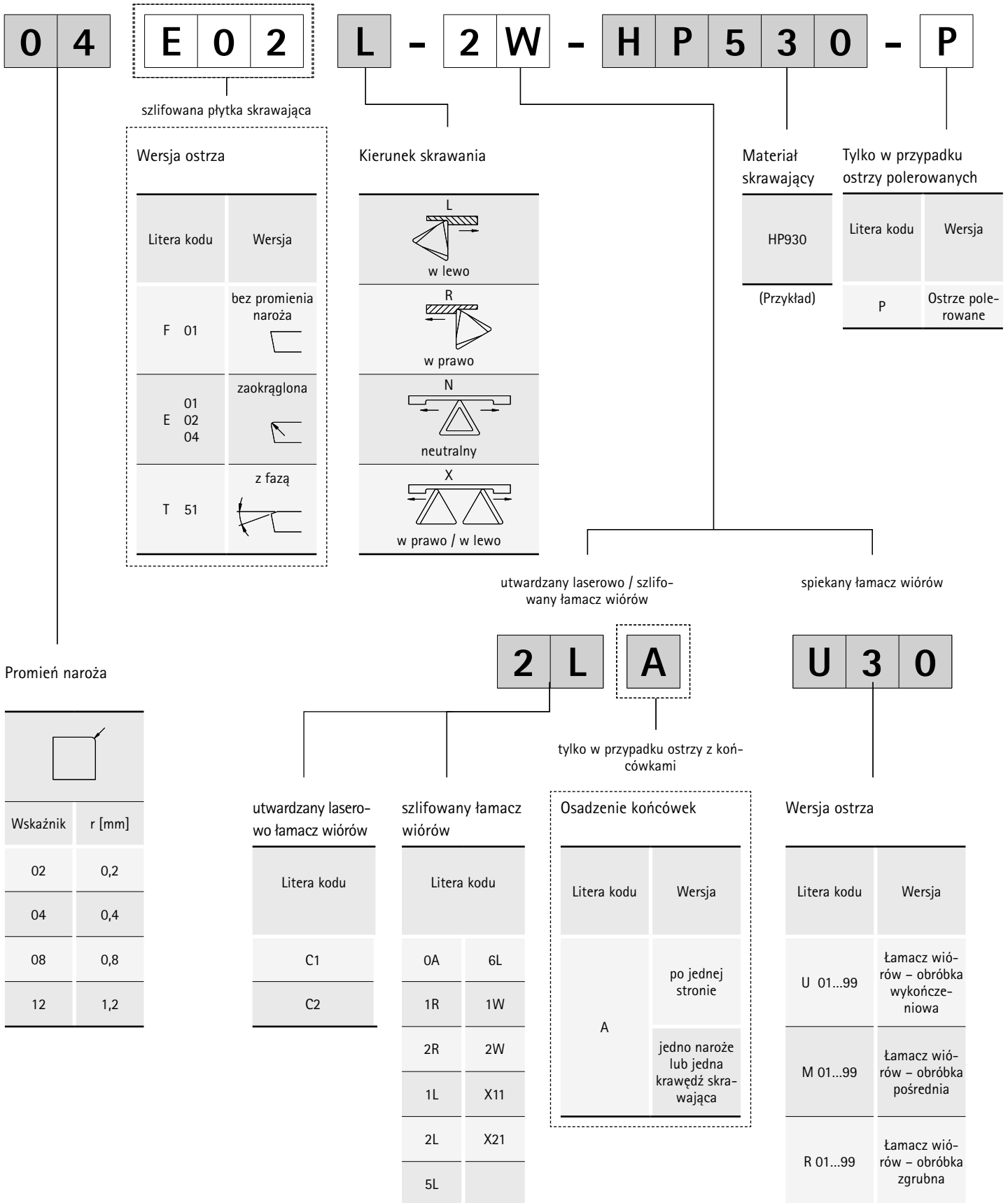

nie dotyczy ostrzy spiekanych





Oznaczenia – płytki skrawające styczne

C
T
H
Q
09
05
08





Kształt płytki

C (80°) 
F (70°) 
S (90°) 

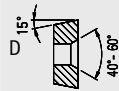

Tolerancja

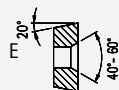
		
	d [mm]	s [mm]
H	±0,013	±0,025
G	±0,025	±0,13
N	±0,05 - ±0,15	±0,025

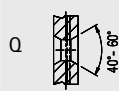
Typ płytki

Wielkość płytki

Okrag wewnętrzny			
d [mm]	C	F	S
6,35	06/09	06	06
9,525	09/13	09	09
12,7	12/18	12	-

WSP

T
Styczna

Grubość płytki

	Wskaźnik	s [mm]
	03	3,18
	T3	3,97
	04	4,76
	05	5,56
	06	6,35

Promień naroża

	Wskaźnik	r [mm]
	00	0
	04	0,4
	08	0,8
	12	1,2

H 0 2

L

0 0

B 0 4 1

- H P 9 4 5

Kierunek skrawania

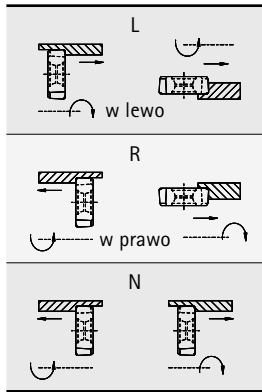

Kąt przystawienia

Nawiercanie	
Szlif okrągły	
Wskaźnik	Kąt
00	0°
10	10°

Materiał skrawający

HP950
(Przykład)

Łamacz wiórów





Litera kodu
A 01...99
D 01...99
G 01...99
H 01...99

Szlif okrągły

Szlif okrągły			
	Wskaźnik	Promień	
Polożenie montażowe	B012	12	CTHQ/FTHQ
	B016	16	
	B021	21	
	B041	40	
	B081	80	

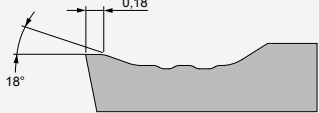
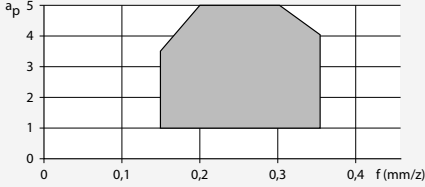
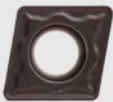
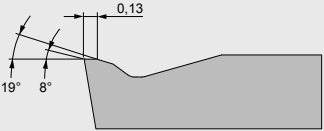
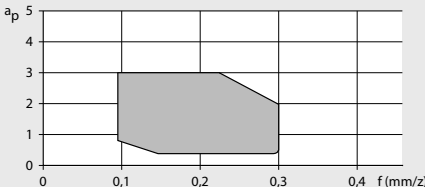
Przegląd łamaczy wiórów – nawieranie

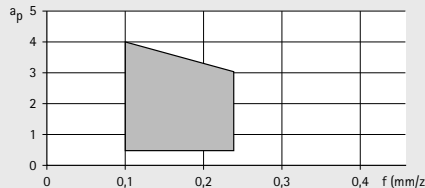
Płytki skrawające promieniowe

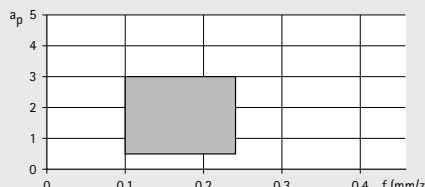
	Typ	Grupa materiałowa	Zaokrąglenie krawędzi	Wykres
Obróbka zgrubna	MKM  	P M K N	+++	
	MGP  	P M K N	++	
Obróbka pośrednia	0A*  	P M K N	+ ++	
	0AA*  	P M K N	0 + ++	

*Ten łamacz wiórów jest dostępny w wersjach z różnymi zaokrągleniami krawędzi.
 0 = bez promienia naroża | + = lekko zaokrąglona | ++ = średnio zaokrąglona | +++ = mocno zaokrąglona

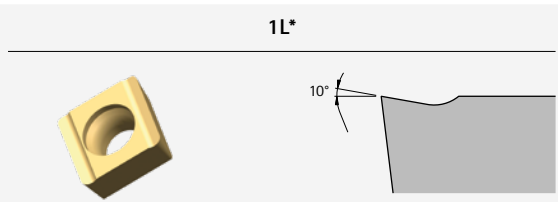
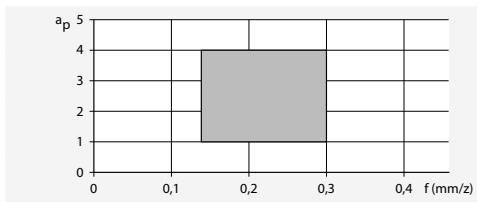
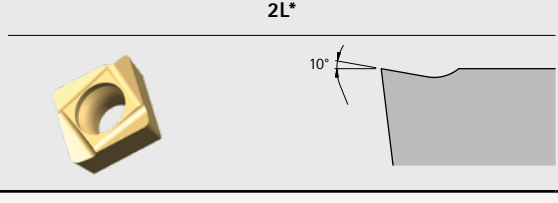
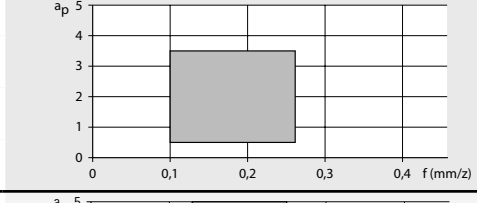
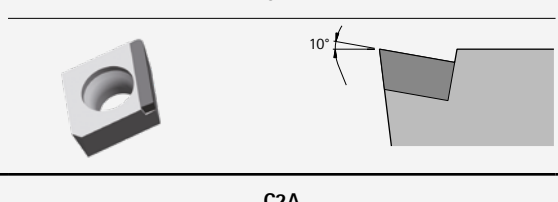
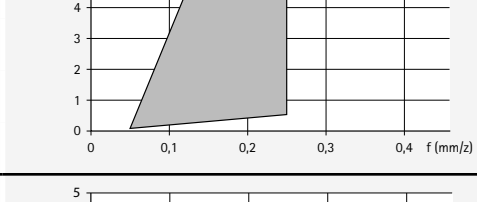
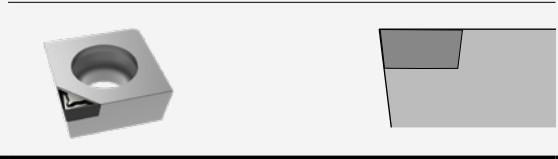
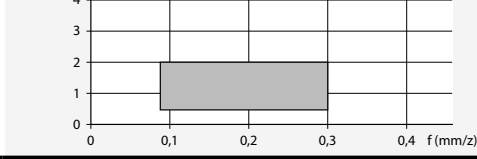
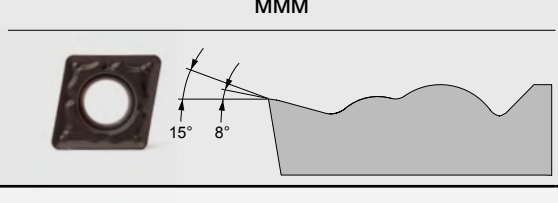
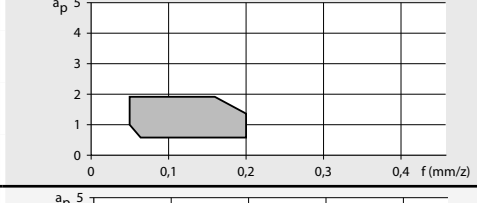
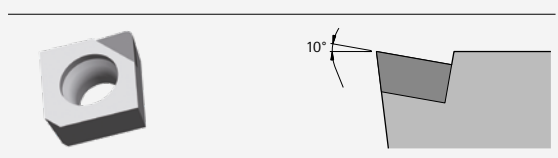
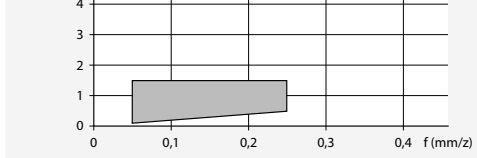
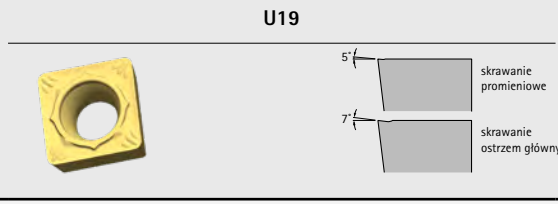
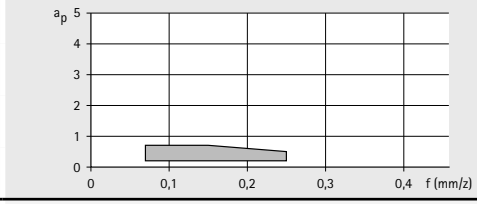
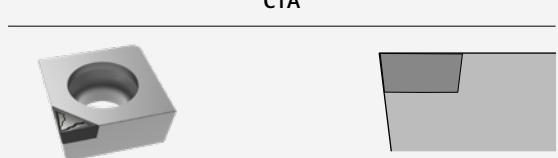
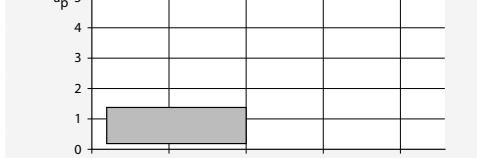
	Typ	Grupa materiałowa	Zaokrąglenie krawędzi	Wykres
Obróbka pośrednia	1L* 	P M K N	+ ++	
	2L* 	P M K N	+ ++	
	6LA 	P M K N	0	
	C2A 	P M K N	0	
Obróbka wykończeniowa	MMM 	P M K N	++	
	5LA 	P M K N	0	
	U19 	P M K N	+	
	C1A 	P M K N	0	

Przegląd łamaczy wiórów – nawiercanie

Płytki skrawające promieniowe

	Typ	Grupa materiałowa	Zaokrąglenie krawędzi	Wykres
Obróbka mieszana	1R* 	P M K N	0 +	
	2R* 	P M K N	0 +	
	1W 	P M K N	+	
	2W 	P M K N	+	

Oznaczenia na wytłaczanych płytkach skrawających „press-to-size”







* Ten łamacz wiórów jest dostępny w wersjach z różnymi zaokrągleniami krawędzi.
 0 = bez promienia naroża | + = lekko zaokrąglona | ++ = średnio zaokrąglona | +++ = mocno zaokrąglona

Notatki

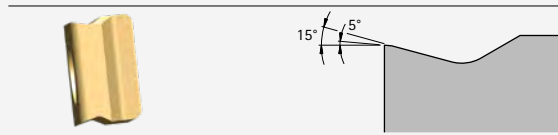
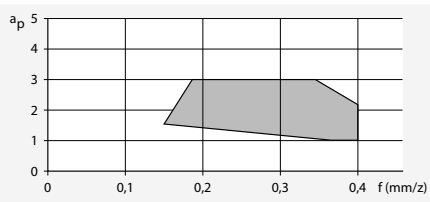
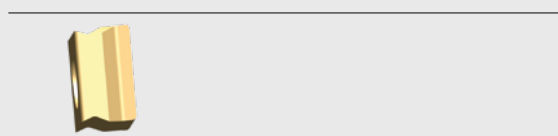
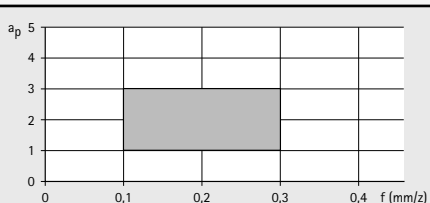
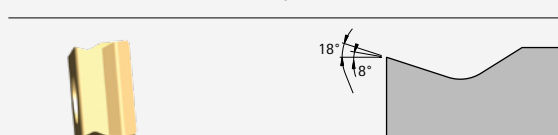
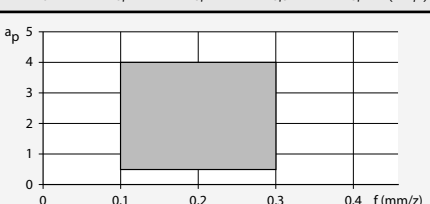
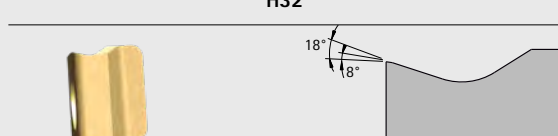
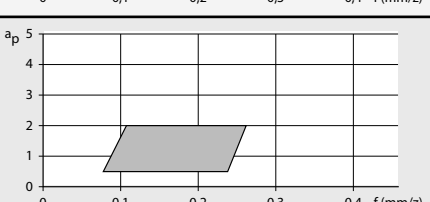
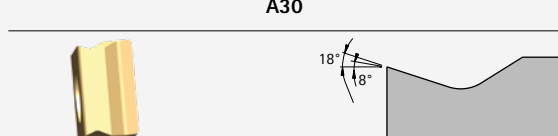
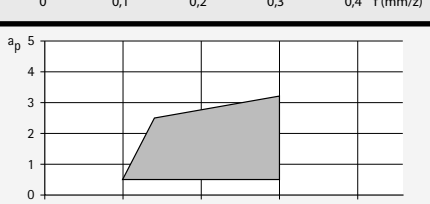
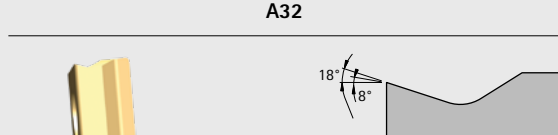
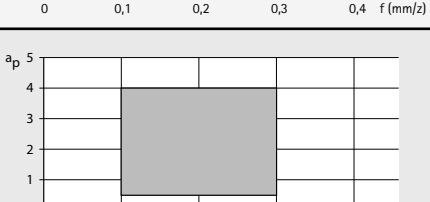
Przegląd łamaczy wiórów – nawiercanie

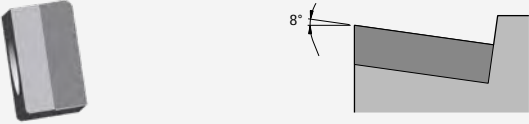
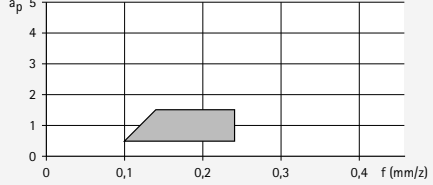
Płytki skrawające styczne

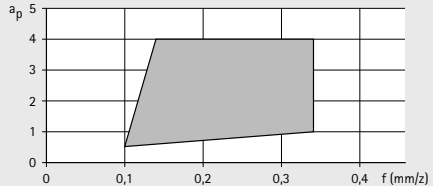
	Typ	Grupa materiałowa	Zaokrąglenie krawędzi	Wykres
Obróbka zgrubna	A53 	P	++	
		M		
		K		
		N		
Obróbka zgrubna	A32 	P	++	
		M		
		K		
		N		
Obróbka zgrubna	H02 	P	++	
		M		
		K		
		N		
Obróbka zgrubna	H32 	P	++	
		M		
		K		
		K		
Obróbka pośrednia	A30 	P	0	
		M		
Obróbka pośrednia	A32 	P	++	
		M		
		K		
		N		

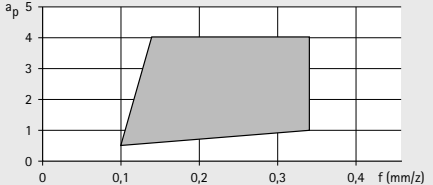
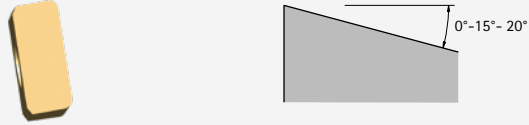
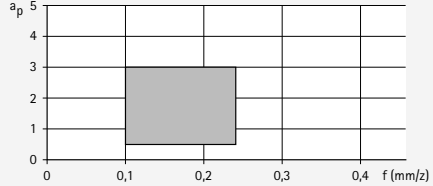
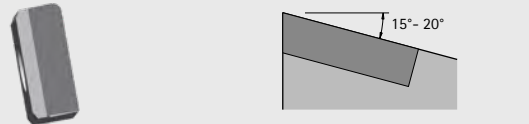
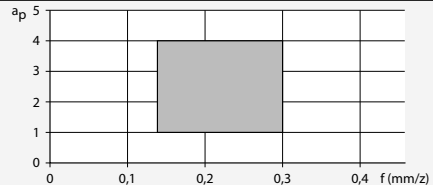
	Typ	Grupa materiałowa	Zaokrąglenie krawędzi	Wykres
Obróbka pośrednia	A79 	P	0	
	M			
K				
N				
Obróbka pośrednia	A80 	P	0	
	M			
K				
N				
Uniwersalne	D00 	P	0	
	M			
	K			
N				
Uniwersalne	D02 	P	++	
	M			
	K			
N				
Uniwersalne	D80 	P	0	
	M			
	K			
	N			

CCMT

Płytki skrawająca promieniowa,
dwostrzowa, wersja neutralna



Materiał obrabiany	P						
	niestopowy ← odporny na ścieranie		stopowy → ciągliwy	niestopowy ← odporny na ścieranie			
Podłoże	Węgiel spiekany						
Powłoka	CVD			PVD			
Rodzaj materiału skrawającego	HC850	HC855	HC865	HP880	HP895		
Wersja ostrza	MKM		MKM				
CCMT06	a_p max. [mm]						
Obróbka zgrubna	CCMT060204N-...-	1,5 - 2,5					
	CCMT09						
	CCMT09T304N-...-	1,5 - 3,0		30966062			
		1,5 - 4,0					
	CCMT09T308N-...-	1,5 - 3,0	31265843	30985462			
		1,5 - 4,0					
	CCMT12						
	CCMT120408N-...-	1,5 - 4,0	31265844	30985477			
		1,5 - 5,0					
	CCMT120412N-...-	1,5 - 4,0	31265846	30985485			
1,5 - 5,0							
Wersja ostrza	MGP	MGP	MGP	MGP	MGP		
CCMT06	a_p max. [mm]						
Obróbka pośrednia	CCMT060202N-...-	0,25 - 2,0					
	CCMT060204N-...-	0,5 - 2,0	30985423		30985422		
	CCMT060208N-...-	0,75 - 2,0	30985443		30985442		
	CCMT09						
	CCMT09T302N-...-	0,25 - 3,0	30985451				
	CCMT09T304N-...-	0,5 - 3,0		30985455	31092654	30966057	30966058
	CCMT09T308N-...-	0,75 - 3,0	31265842	30985892	30985461	30985891	30985460
	CCMT12						
	CCMT120404N-...-	0,5 - 3,0	30985470				
	CCMT120408N-...-	0,75 - 3,0	30985473	30985474			
CCMT120412N-...-	1,0 - 3,0	31265845	31092655				
Wersja ostrza	MMM		MMM	MMM	MMM		
CCMT06	a_p max. [mm]						
Obróbka wykończeniowa	CCMT060202N-...-	0,5 - 1,0	30985415		30985414		
	CCMT060204N-...-	0,5 - 1,0	30985435	30985436	30985432	30985433	
	CCMT060208N-...-	0,5 - 1,0				30985448	
	CCMT09						
	CCMT09T302N-...-	0,5 - 1,0	30985453			30985452	
	CCMT09T304N-...-	0,5 - 1,0	30985887	30966053	30966070	30955706	
	CCMT09T308N-...-	0,5 - 1,0	30985465	30985896	30985894	30985895	

M					K		
austenityczny ← odporny na ścieranie		ferrytyczny → ciągliwy	austenityczny ← odporny na ścieranie		ferrytyczny → ciągliwy	GJL ← odporny na ścieranie	GJS → ciągliwy
Węglik spiekany					Węglik spiekany		
CVD		PVD			CVD		
HC875	HC885	HP880	HP885	HP895	HC820	HC830	
					MKM	MKM	
					30985425	30985427	
					30966120	30985884	
					30966113	30985893	
					30985475	30985476	
					30985481	30985483	
	MGP	MGP	MGP	MGP	MGP	MGP	
	30985420	30985421		31245556	30985422	30985413	30985417
				31245557	30985442	30985439	30985441
						30985450	
	30985883	30966056	30966057	31245558	30966058	30985882	30985454
	30985459	30985890	30985891	31245559	30985460	30985888	30985889
						30985467	30985469
	30985899					30985472	30985898
						30985479	
			MMM	MMM	MMM	MMM	MMM
					30985414		
			30985432	31245539	30985433	30985429	30985431
				31245541	30985448	30985445	30985447
					30985452		
			30966070	31245543	30955706	30985885	30985886
			30985894	31245545	30985895	30985463	30985464

CCGT

Płytki skrawająca promieniowa, dwuostrzowa, wersja neutralna



węgiel spiekany/cermet

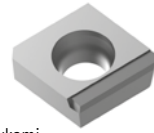

6LA

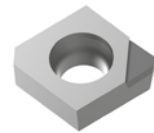

5LA



C1A



C2A

Warianty z końcówkami,
jednoostrzowe:

Materiał obrabiany	P		M	N		
				Al stop. ← odporny na ścieranie → Cu stop. ciągliwy		
Podłoże	Cermet	Węgiel spiekany	Węgiel spiekany	PCD		
Powłoka	CVD	PVD	PVD	-		
Rodzaj materiału skrawającego	CC112	HP895	HP895	PU617	PU660	PU670

Wersja ostrza	a_p max. [mm]	MGP		6LA	C2A	
CCGT06						
CCGT060202N-...-...	0,25 - 2,0		30985376	30985376		
CCGT060204F01L-...-...	0,1 - 3,0			30708850		
CCGT060204F01R-...-...	0,1 - 3,0			31277722		
CCGT060204N-...-...	0,5 - 2,0		30985378	30985378		
CCGT060208F01L-...-...	0,1 - 3,0			30375239		
CCGT060208F01R-...-...	0,1 - 3,0			31204099		
CCGT060208N-...-...	0,75 - 2,0		30985393	30985393		
CCGT09						
CCGT09T302N-...-...	0,25 - 3,0		30985398	30985398		
CCGT09T304F01L-...-...	0,1 - 4,5			30370125		
CCGT09T304F01R-...-...	0,1 - 4,5			30497774		
CCGT09T304F01N-...-...	0,4 - 1,6					30234061
CCGT09T304N-...-...	0,5 - 3,0		30985400	30985400		
CCGT09T308F01L-...-...	0,1 - 4,5			30370124		
CCGT09T308F01R-...-...	0,1 - 4,5			30370397		
CCGT09T308F01N-...-...	0,5 - 2,0					30234062
CCGT09T308N-...-...	0,75 - 3,0		30985406	30985406		
CCGT12						
CCGT120404N-...-...	0,5 - 3,0		30985410	30985410		
CCGT120404F01L-...-...	0,1 - 7,0			31025433		
CCGT120408N-...-...	0,5 - 3,0		30985411	30985411		
CCGT120408F01L-...-...	0,1 - 7,0			30589862		

Wersja ostrza	a_p max. [mm]	U19	5LA		C1A	
CCGT06						
CCGT060204N-...-...	0,1 - 0,5	30874908				
CCGT060204F01N-...-...	0,1 - 1,0			30708851	10104313	
CCGT060208N-...-...	0,2 - 0,5	30799422				
CCGT060208F01N-...-...	0,1 - 1,5			31277724		
CCGT09						
CCGT09T304F01N-...-...	0,1 - 2,0			31079089		
CCGT09T304F01N-...-...	0,1 - 1,0				10099042	
CCGT09T308F01N-...-...	0,1 - 2,0			31277725		
CCGT09T308F01N-...-...	0,15 - 1,4				30234050	

CCGW

Płytki skrawające promieniowe, dwuostrzowe, wersja neutralna

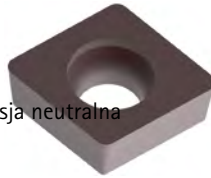

Wariant z końcówkami, jednoostrzowe:

OAA

Materiał obrabiany	K			N	
	GJL ← odporny na ścieranie	GJS → ciągliwy	GJL ← odporny na ścieranie	GJS → ciągliwy	GJL ← odporny na ścieranie
Podłoże	Węgiel spiekany			PcBN	PCD
Powłoka	CVD	PVD	-	-	-
Rodzaj materiału skrawającego	HC740	HP930	FU430	PU617	

Wersja ostrza		OA	OA	OAA		
CCGW06 a_p max. [mm]						
Obróbka pośrednia	CCGW060204E04N-...-...	0,5 - 3,2	31317178	30950259		
	CCGW060204T51N-...-...	0,5 - 2,0		10105523		
	CCGW060208E04N-...-...	0,5 - 3,2	31317202	30950280		
	CCGW09					
	CCGW09T304E04N-...-...	0,5 - 4,0	31027805	30950281		
	CCGW09T304T51N-...-...	0,5 - 2,5		10105636		
	CCGW09T308E04N-...-...	0,5 - 4,0	31023434	30950282		
	CCGW09T308T51N-...-...	0,5 - 2,5		10105650		
CCGW09T312E04N-...-...	0,5 - 4,0	31317207	30950283			

Wersja ostrza			OA	OAA	OAA	
CCGW06 a_p max. [mm]						
Obróbka wykończeniowa	CCGW060202F01N-...-...	0,1 - 1,0			31277730	
	CCGW060204F01N-...-...	0,1 - 1,0			30492177	
	CCGW060204E01N-...-...	0,1 - 1,0		10105520		
	CCGW060204E02N-...-...	0,2 - 1,0		30950284		
	CCGW060208E02N-...-...	0,2 - 1,0		30950285		
	CCGW09					
	CCGW09T304F01N-...-...	0,1 - 1,0			30418983	
	CCGW09T304E01N-...-...	0,1 - 1,0		10105634		
	CCGW09T304E02N-...-...	0,2 - 2,0		30950286		
	CCGW09T308F01N-...-...	0,1 - 1,0			30492178	
CCGW09T308E01N-...-...	0,1 - 1,0		10105648			
CCGW09T308E02N-...-...	0,2 - 2,0		30950287			

CCHT

Płytki skrawające promieniowe, dwustrzowe, wersja lewa

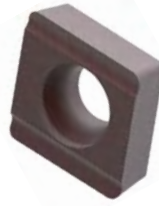

Materiał obrabiany	K		N	
Podłoże	Węglik spiekany		Węglik spiekany	
Powłoka	CVD	PVD	-	PVD
Rodzaj materiału skrawającego	HC740	HP930	HU616	HP615

Wersja ostrza		1L	1L		1R	
CCHT06 a_p max. [mm]						
Obróbka pośrednia	CCHT060204E04L-...-...	0,5 - 3,2	31041976	30950288		
	CCHT060208E04L-...-...	0,5 - 3,2	31115820	30950289		
	CCHT09					
	CCHT09T302F01L-...-...	0,5 - 4,0				30492197
	CCHT09T304F01L-...-...	0,5 - 4,0				30478168
	CCHT09T304E04L-...-...	0,5 - 4,0	30963744	30950290		
	CCHT09T308F01L-...-...	0,5 - 4,0				30484471
	CCHT09T308E04L-...-...	0,5 - 4,0	30884324	30950291		
	CCHT09T312E04L-...-...	0,5 - 4,0	30884469	30950292		
	CCHT12					
	CCHT120404E04L-...-...	0,5 - 5,0	30963715	30950293		
	CCHT120408E04L-...-...	0,5 - 5,0	30894700	30950294		
	CCHT120412E04L-...-...	0,5 - 5,0	31317213	30950295		

Wersja ostrza			1L	1R	1R	
CCHT06 a_p max. [mm]						
Obróbka wykończeniowa	CCHT060202F01L-...-...	0,1 - 1,0			30010702	
	CCHT060204F01L-...-...	0,1 - 1,4			30010703	
	CCHT060204E02L-...-...	0,1 - 1,0		30950296		
	CCHT060208F01L-...-...	0,1 - 1,8			30010704	
	CCHT060208E02L-...-...	0,1 - 1,0		30950297		
	CCHT09					
	CCHT09T302F01L-...-...	0,1 - 2,0			30010705	30492197
	CCHT09T304F01L-...-...	0,1 - 2,0			30010706	30478168
	CCHT09T304E02L-...-...	0,1 - 2,0		30950298		
	CCHT09T308F01L-...-...	0,1 - 2,0			30010707	30484471
	CCHT09T308E02L-...-...	0,1 - 2,0		30950299		
	CCHT09T312F01L-...-...	0,1 - 2,0			30084580	
	CCHT12					
	CCHT120402F01L-...-...	0,1 - 3,0			30010708	
CCHT120404F01L-...-...	0,1 - 3,0			30010709		
CCHT120408F01L-...-...	0,1 - 3,0			30010710		
CCHT120412F01L-...-...	0,1 - 3,0			30010711		

CCHT

Płytki skrawające promieniowe, dwuostrzowe, wersja prawa

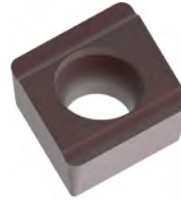

Materiał obrabiany	K		N	
Podłoże	Węglik spiekany		Węglik spiekany	
Powłoka	CVD	PVD	-	PVD
Rodzaj materiału skrawającego	HC740	HP930	HU616	HP615

Wersja ostrza		1L	1L		1R	
CCHT06		a_p max. [mm]				
Obróbka pośrednia	CCHT060204E04R-...-...	0,5 - 3,2	31317208	30950300		
	CCHT060208E04R-...-...	0,5 - 3,2	31317209	30950301		
	CCHT09					
	CCHT09T304F01R-...-...	0,5 - 4,0				30478169
	CCHT09T304E04R-...-...	0,5 - 4,0	31115392	30950302		
	CCHT09T308F01R-...-...	0,5 - 4,0				30492211
	CCHT09T308E04R-...-...	0,5 - 4,0	31041977	30950303		
	CCHT09T312E04R-...-...	0,5 - 4,0	31317210	30950304		
	CCHT12					
	CCHT120404E04R-...-...	0,5 - 5,0	31317211	30950305		
	CCHT120408E04R-...-...	0,5 - 5,0	31317212	30950306		
	CCHT120412E04R-...-...	0,5 - 5,0	31317214	30950307		

Wersja ostrza			1L	1R	1R	
CCHT06		a_p max. [mm]				
Obróbka wykończeniowa	CCHT060202F01R-...-...	0,1 - 1,0			30010732	
	CCHT060204F01R-...-...	0,1 - 1,4			30010733	
	CCHT060204E02R-...-...	0,1 - 1,0		30950308		
	CCHT060208F01R-...-...	0,1 - 1,8			30010734	
	CCHT060208E02R-...-...	0,1 - 1,0		30950309		
	CCHT09					
	CCHT09T302F01R-...-...	0,1 - 2,0			30010735	
	CCHT09T304F01R-...-...	0,1 - 2,0			30010736	30478169
	CCHT09T304E02R-...-...	0,1 - 2,0		30950310		
	CCHT09T308F01R-...-...	0,1 - 2,0			30010737	30492211
	CCHT09T308E02R-...-...	0,1 - 2,0		30950311		
	CCHT09T312F01R-...-...	0,1 - 2,0			30492212	
	CCHT12					
	CCHT120402F01R-...-...	0,1 - 3,0			30010738	
	CCHT120404F01R-...-...	0,1 - 3,0			30010739	
	CCHT120408F01R-...-...	0,1 - 3,0			30010740	
CCHT120412F01R-...-...	0,1 - 3,0			30010741		

DCMT | DCGT | DCGW

Płytki skrawająca promieniowa, dwuostrzowa, wersja neutralna

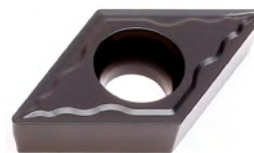

Materiał obrabiany	P				
	niestopowy ← odporny na ścieranie		stopowy → ciągliwy	niestopowy ← odporny na ścieranie	stopowy → ciągliwy
Podłoże	Węgiel spiekany				
Powłoka	CVD			PVD	
Rodzaj materiału skrawającego	HC850	HC855	HC865	HP880	HP895

Wersja ostrza			MKM		
DCMT11	a_p max. [mm]				
Obróbka zgrubna	DCMT11T304N-...-...	1,5 - 2,5		30966087	
		1,5 - 3,0			
	DCMT11T308N-...-...	1,5 - 3,0		30966078	
		1,5 - 4,0			

Wersja ostrza		MGP	MGP	MGP	MGP	MGP	
DCMT07	a_p max. [mm]						
Obróbka pośrednia	DCMT070202N-...-...	0,25 - 1,8					
	DCMT070204N-...-...	0,5 - 2,0	30985499			30985498	
	DCMT070208N-...-...	0,75 - 2,0			31092658		
	DCMT11						
	DCMT11T304N-...-...	0,25 - 2,0	31092656	30985510	30966101	30966092	30966093
	DCMT11T308N-...-...	0,5 - 2,5	30966103	30985518		30966082	30966083
	DCGT11						
	DCGT11T304F01N-...-...	0,4 - 1,5					
	DCGT11T308F01N-...-...	0,5 - 1,8					
	DCMT15						
	DCMT150404N-...-...	0,5 - 2,5					
	DCMT150408N-...-...	0,5 - 3,0					
DCMT150412N-...-...	0,5 - 3,0						

Wersja ostrza		MMM		MMM	MMM	MMM	
DCMT07	a_p max. [mm]						
Obróbka wykończeniowa	DCMT070202N-...-...	0,5 - 1,0		30985495		30985494	
	DCMT070204N-...-...	0,5 - 1,0	30986033			30985500	
	DCMT070208N-...-...	0,5 - 1,0					
	DCMT11						
	DCMT11T302N-...-...	0,5 - 1,5	30966100			30985505	
	DCMT11T304N-...-...	0,5 - 1,5	30985902		30966088	30966095	30966096
	DCMT11T308N-...-...	0,5 - 1,5	30966104		30966079	30966085	30966086
	DCGT11						
	DCGT11T304F01N-...-...	0,1 - 1,0					
	DCGT11T308F01N-...-...	0,15 - 1,4					
	DCGW11						
	DCGW11T304F01N-...-...	0,1 - 2,0					
	DCGW11T304E01N-...-...	0,1 - 1,0					
	DCGW11T308F01N-...-...	0,1 - 2,0					
	DCGW11T308F01N-...-...	0,1 - 1,0					

Podane zakresy a_p stanowią wartości zalecane i mogą się różnić w zależności od obrabianego materiału.

Wariant z końcówkami, jednostrzowe:

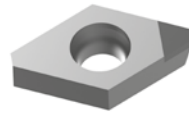

0AA



C1A



C2A

M					K			N			
austenityczny ← odporny na ścieranie		ferrytyczny → ciągliwy	austenityczny ← odporny na ścieranie		ferrytyczny → ciągliwy	GJL ← odporny na ścieranie		GJS → ciągliwy	Al stop. ← odporny na ścieranie		Cu stop. → ciągliwy
Węglík spiekany					Węglík spiekany		PcBN	PCD			
CVD		PVD			CVD		-	-			
HC875	HC885	HP880	HP885	HP895	HC815	HC825	FU430	PU617	PU660	PU670	
					MKM	MKM					
					30985511	30985512					
					30985519	30985520					
	MGP	MGP	MGP	MGP	MGP	MGP				C2A	
					30985493						
				30985498	30985496	30985497					
					30985501	30985502					
	30985508	30966091	30966092	31245560	30966093	30985506	30985507				
	30985517		30966082	31245562	30966083	30985515	30985516				
										30234066	
										30234067	
					30985522						
					30985523						
					30985524						
	MMM		MMM	MMM	MMM		0AA	0AA	1CA		
	30966105				30985494						
	30966107			31245546	30985500						
				31245547							
					30985505						
			30966095	31245548	30966096	30985513					
	30985903		30966085	31245549	30966086						
										30234052	
										30234053	
									31212079		
							10105921				
									31277726		
							10105952				



SCMT | SPMT | SCGT | SPGT

Płytki skrawająca promieniowa,
czteroostrzowa, wersja neutralna

Materiał obrabiany	P					
	niestopowy ← odporny na ścieranie		stopowy → ciągliwy		niestopowy ← odporny na ścieranie	
Podłoże	Cermet		Węgiel spiekany			
Powłoka	CVD		CVD		PVD	
Rodzaj materiału skrawającego	CC112	HC850	HC855	HC865	HP880	HP895

Wersja ostrza			MKM		MKM		
SCMT09		a_p max. [mm]					
Obróbka zgrubna	SCMT09T308N-...-...	1,5 - 3,0	31265847		30966072		
		1,5 - 4,0					
	SCMT12	1,5 - 4,0	31265848		30985564		
		1,5 - 5,0					
SCMT120412N-...-...	1,5 - 4,0	31265849					
	1,5 - 5,0						

Wersja ostrza			MGP	MGP	MGP		MGP
SPMT06		a_p max. [mm]					
Obróbka pośrednia	SPMT060304N-...-...	0,5 - 2,0	30985573		30985575		
		0,75 - 2,0			31265851		
	SCMT09	0,5 - 3,0	31085129		31085141		30985536
		0,75 - 3,0	31085140	30985543	30966127		
	SCMT09T312N-...-...	1 - 3,0	31276723		31273621		
	SCGT09						
	SCGT09T308F01N-...-...	0,5 - 2,0					
	SCMT12						
	SCMT120404N-...-...	0,5 - 3,0					
	SCMT120408N-...-...	0,75 - 3,0	31085142	30985560	31085143		

Wersja ostrza			U19	MMM	MMM	MMM	MMM
SPMT06		a_p max. [mm]					
Obróbka wykończeniowa	SPMT060304N-...-...	0,5 - 2,0		30985579		30985580	30985577
							30985913
	SPGT06	0,1 - 0,8					
		0,1 - 3,0					
	SPGT060304F01N-...-...	0,1 - 0,8					
	SPGT060304F01L-...-...	0,1 - 3,0					
	SPGT060308F01N-...-...	0,1 - 0,8					
	SPGT060308F01L-...-...	0,1 - 3,0					
	SPGT060308F01R-...-...	0,1 - 3,0					
	SCMT09						
	SCMT09T304N-...-...	0,5 - 1,5		31085144		31085145	30985540
	SCMT09T308N-...-...	0,5 - 1,5		30983531		30966073	30955704
	SCGT09						
	SCGT09T304N-...-...	0,1 - 0,5	30647885				
	SCGT09T304F01N-...-...	0,1 - 0,5					
	SCGT09T304F01L-...-...	0,1 - 4,5					
	SCGT09T304F01R-...-...	0,1 - 4,5					
SCGT09T308N-...-...	0,1 - 0,5	10102893					
SCGT09T308F01N-...-...	0,1 - 0,5						
SCGT09T308F01L-...-...	0,15 - 1,4						
SCGT09T308F01R-...-...	0,1 - 4,5						
SCGT09T308F01R-...-...	0,1 - 4,5						

Podane zakresy a_p stanowią wartości zalecane i mogą się różnić w zależności od obrabianego materiału.

Warianty z końcówkami, jednoostrzowe:

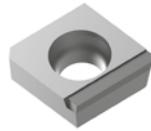

6LA

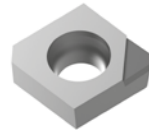

5LA



C1A



C2A

M				K		N					
austenityczny odporny na ścieranie		ferytyczny ciągły	austenityczny odporny na ścieranie		ferytyczny ciągły	GJL odporny na ścieranie		GJS ciągły	Al stop. odporny na ścieranie		Cu stop. ciągły
Węglik spiekany						PCD					
CVD		PVD				-					
HC875	HC885	HP880	HP895	HC820	HC830	PU617	PU660	PU670			
					MKM	MKM					
					30985545	31092659					
					30985562	31092660					
					30985566	31092661					
MGP		MGP		MGP	MGP	C2A					
					30985574	30985576					
					30985914	30985915					
30985535				30985536	30985908	30985534					
31092662					30985911	30985912					
							30249457				
					30985552	30985554					
30985559					30985556	30985558					
MMM		MMM	MMM	MMM	MMM	5LA	6LA	C1A			
30972033		30985577	30985913	30985578	31084646						
						31277727					
						30373268					
						31279699					
						31279698					
						31217111					
						31279720					
		30966076		30985540	30985538	30985539					
				30955704	30985548	30985550					
						30374908					
						30546951					
						31279721					
						30692832					
								30250261			
						30568596					
						31279723					

SCGW | SPGW

Płytki skrawające promieniowe, czterostrzowe

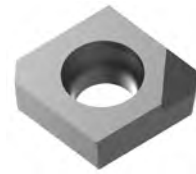
Wariant z końcówkami,
jednostrzowe:

0AA

Materiał obrabiany	K			N		
		GJL ← odporny na ścieranie	GJS → ciągliwy	GJL ← odporny na ścieranie	GJS → ciągliwy	GJL ← odporny na ścieranie
Podłoże	Węgiel spiekany			PcBN		PCD
Powłoka	CVD		PVD		-	
Rodzaj materiału skrawającego	HC740		HP930		FU430	

Wersja ostrza		0A	0A	0AA	
SPGW06	a_p max. [mm]				
SPGW060304E04N-...-...	0,5 - 3,2	31070945	30950312		
SPGW060308E04N-...-...	0,5 - 3,2	31050739	30950313		
SCGW09					
SCGW09T304E04N-...-...	0,5 - 4,0	31022296	30950314		
SCGW09T304T51N-...-...	0,5 - 2,5			10106285	
SCGW09T308E04N-...-...	0,5 - 4,0	31022297	30950315		
SCGW09T308T51N-...-...	0,5 - 2,5			10106299	
SCGW12					
SCGW120404E04N-...-...	0,5 - 5,0	31317220	30950316		
SCGW120408E04N-...-...	0,5 - 5,0	30939413	30950317		

Wersja ostrza		0A	0AA	0AA
SPGW06	a_p max. [mm]			
SPGW060304F01N-...-...	0,1 - 1,2			31277731
SPGW060304E02N-...-...	0,2 - 1,0	30950318		
SPGW060308F01N-...-...	0,1 - 1,0			31279738
SPGW060308E02N-...-...	0,2 - 1,0	30950319		
SCGW09				
SCGW09T304F01N-...-...	0,1 - 1,4			31277732
SCGW09T304E01N-...-...	0,1 - 1,0		10106283	
SCGW09T304E02N-...-...	0,2 - 2,0	30950320		
SCGW09T308F01N-...-...	0,1 - 1,8			30429723
SCGW09T308E01N-...-...	0,1 - 1,0		10106297	
SCGW09T308E02N-...-...	0,2 - 2,0	30950321		
SCGW12				
SCGW120404F01N-...-...	0,1 - 1,4			31279752
SCGW120408F01N-...-...	0,1 - 1,8			31279753

SCHT | SPHT

Płytki skrawające promieniowe, dwustrzowe, wersja neutralna

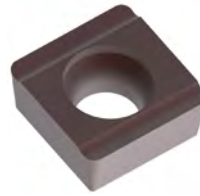

Materiał obrabiany	K		N	
	GJL ← odporny na ścieranie	GJS → ciągliwy	GJL ← odporny na ścieranie	GJS → ciągliwy
Podłoże	Węglik spiekany			Węglik spiekany
Powłoka	CVD		PVD	
Rodzaj materiału skrawającego	HC740		HP930	
			HU616	

Wersja ostrza		1L	1L		
SPHT06 a_p max. [mm]					
Obróbka pośrednia	SPHT060304E04X-...-...	0,5 - 3,2	31042317	30953122	
	SPHT060308E04X-...-...	0,5 - 3,2	31317315	30953126	
	SCHT09				
	SCHT09T304E04X-...-...	0,5 - 4,0	31121604	30953127	
	SCHT09T308E04X-...-...	0,5 - 4,0	30963756	30953128	
	SCHT09T312E04X-...-...	0,5 - 4,0	31317219	30953150	
	SCHT12				
	SCHT120404E04X-...-...	0,5 - 5,0	31081857	30953151	
	SCHT120408E04X-...-...	0,5 - 5,0	31317304	30953152	
	SCHT120412E04X-...-...	0,5 - 5,0	31317308	30953154	

Wersja ostrza			1L	1R	
SPHT06 a_p max. [mm]					
Obróbka wykończeniowa	SPHT060304E02X-...-...	0,1 - 1,0	30953158		
	SPHT060308E02X-...-...	0,1 - 1,0	30953164		
	SCHT09				
	SCHT09T302F01X-...-...	0,1 - 2,0		30141062	
	SCHT09T304F01X-...-...	0,1 - 2,0		30010681	
	SCHT09T304E02X-...-...	0,1 - 2,0	30953159		
	SCHT09T308F01X-...-...	0,1 - 2,0		30010682	
	SCHT09T308E02X-...-...	0,1 - 2,0	30953168		
	SCHT09T312F01X-...-...	0,1 - 2,0		30492274	
	SCHT12				
SCHT120404F01X-...-...	0,1 - 3,0		30010683		
SCHT120408F01X-...-...	0,1 - 3,0		30010684		

SCHT | SPHT

Płytki skrawające promieniowe, czterostrzowe

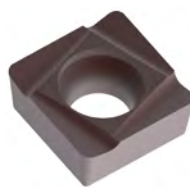

wersja lewa

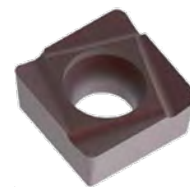

wersja prawa

Materiał obrabiany	K		N	
	GJL ← odporny na ścieranie	GJS → ciągliwy	GJL ← odporny na ścieranie	GJS → ciągliwy
Podłoże	Węglik spiekany		Węglik spiekany	
Powłoka	CVD		PVD	PVD
Rodzaj materiału skrawającego	HC740		HP930	HU616 HP615

Wersja ostrza		2L	2L	2R	
SPHT06		a_p max. [mm]			
Obróbka pośrednia	SPHT060302F01L-...-...	0,5 - 3,2		30492231	
	SPHT060302F01R-...-...	0,5 - 3,2		30492248	
	SPHT060304F01L-...-...	0,5 - 3,2		30239958	
	SPHT060304F01R-...-...	0,5 - 3,2		30492249	
	SPHT060304E04L-...-...	0,5 - 3,2	31044035	30950322	
	SPHT060304E04R-...-...	0,5 - 3,2	30939004	30950346	
	SPHT060308F01L-...-...	0,5 - 3,2			30492232
	SPHT060308F01R-...-...	0,5 - 3,2			30492250
	SPHT060308E04L-...-...	0,5 - 3,2	31317311	30950323	
	SPHT060308E04R-...-...	0,5 - 3,2	31317314	30950347	
	SCHT09				
	SCHT09T304F01L-...-...	0,5 - 4,0			30492235
	SCHT09T304F01R-...-...	0,5 - 4,0			30492252
	SCHT09T304E04L-...-...	0,5 - 4,0	31043583	30950324	
	SCHT09T304E04R-...-...	0,5 - 4,0	30812298	30950348	
	SCHT09T308F01L-...-...	0,5 - 4,0			30042582
	SCHT09T308F01R-...-...	0,5 - 4,0			30492253
	SCHT09T308E04L-...-...	0,5 - 4,0	31039585	30950325	
	SCHT09T308E04R-...-...	0,5 - 4,0	31317215	30950349	
	SCHT09T312E04L-...-...	0,5 - 4,0	31317216	30950326	
SCHT09T312E04R-...-...	0,5 - 4,0	31317217	30950350		
SCHT12					
SCHT120404E04L-...-...	0,5 - 5,0	31317284	30950327		
SCHT120404E04R-...-...	0,5 - 5,0	31317287	30950351		
SCHT120408E04L-...-...	0,5 - 5,0	31317300	30950328		
SCHT120408E04R-...-...	0,5 - 5,0	31317301	30950352		
SCHT120412E04L-...-...	0,5 - 5,0	31317305	30950329		
SCHT120412E04R-...-...	0,5 - 5,0	31317307	30950353		

Następna tabela:
Obróbka wykończeniowa

SCHT | SPHT

Płytki skrawające promieniowe, czterostrzowe

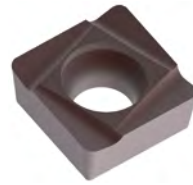

wersja lewa

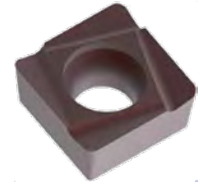

wersja prawa

Materiał obrabiany	K	N
		Al stop. ← odporny na ścieranie
Podłoże		Węglik spiekany
Powłoka	PVD	- PVD
Rodzaj materiału skrawającego	HP930	HU616 HP615

Wersja ostrza		2L	2R	2R	
SPHT06		<i>a_p max. [mm]</i>			
Obróbka wykończeniowa	SPHT060302F01L-...-...	0,1 - 1,0		30092077	30492231
	SPHT060302F01R-...-...	0,1 - 1,0		30089678	30492248
	SPHT060304F01L-...-...	0,1 - 1,0		30010644	30239958
	SPHT060304F01R-...-...	0,1 - 1,0		30010662	30492249
	SPHT060304E02L-...-...	0,1 - 1,0	30950330		
	SPHT060304E02R-...-...	0,1 - 1,0	30950354		
	SPHT060308F01L-...-...	0,1 - 1,0		30057636	30492232
	SPHT060308F01R-...-...	0,1 - 1,0		30438143	30492250
	SPHT060308E02L-...-...	0,1 - 1,0	30950331		
	SPHT060308E02R-...-...	0,1 - 1,0	30950355		
	SCHT09				
	SCHT09T304F01L-...-...	0,1 - 2,0		30010645	30492235
	SCHT09T304F01R-...-...	0,1 - 2,0		30010663	30492252
	SCHT09T304E02L-...-...	0,1 - 2,0	30950332		
SCHT09T304E02R-...-...	0,1 - 2,0	30950356			
SCHT09T308F01L-...-...	0,1 - 2,0		30010646	30042582	
SCHT09T308F01R-...-...	0,1 - 2,0		30010664	30492253	
SCHT09T308E02L-...-...	0,1 - 2,0	30950333			
SCHT09T308E02R-...-...	0,1 - 2,0	30950357			

TCMT | TCGW

Płytki skrawające promieniowa, trójkątna, wersja neutralna

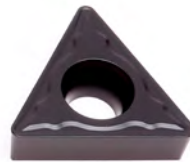

Materiał obrabiany	P				
	niestopowy ← odporny na ścieranie		stopowy → ciągliwy	niestopowy ← odporny na ścieranie	
Podłoże	Węgiel spiekany				
Powłoka	CVD		PVD		
Rodzaj materiału skrawającego	HC850	HC865	HP880	HP895	
Wersja ostrza	MKM				
TCMT11	a_p max. [mm]				
Obróbka zgrubna	TCMT110204N-...-...	1,5 - 3,0	30985591		
		1,5 - 4,0			
	TCMT16				
	TCMT16T304N-...-...	1,5 - 3,0	30985608		
		1,5 - 5,0			
	TCMT16T308N-...-...	1,5 - 3,0	30985615		
		1,5 - 5,0			
Wersja ostrza	MGP		MGP		MGP
TCMT09	a_p max. [mm]				
Obróbka pośrednia	TCMT090204N-...-...	0,5 - 2,0	30985582		
	TCMT11				
	TCMT110204N-...-...	0,5 - 2,5	30945048	30985589	30985588
	TCMT110208N-...-...	0,75 - 2,5	30985599	30985600	30985601
	TCGW11				
	TCGW110204T51N-...-...	0,5 - 2,5			
	TCGW110208T51N-...-...	0,75 - 2,5			
	TCMT16				
	TCMT16T304N-...-...	0,5 - 2,5	30985605	31092663	30985604
	TCMT16T308N-...-...	0,75 - 2,5	30985613	31092665	30985612
TCMT16T312N-...-...	1,0 - 2,5	31092666			
TCMT22					
TCMT220408N-...-...	0,75 - 3,0				
Wersja ostrza	MMM		MMM		MMM
TCMT11	a_p max. [mm]				
Obróbka wykończeniowa	TCMT110202N-...-...	0,5 - 1,5	30985584	30985585	30985583
	TCMT110204N-...-...	0,5 - 1,5	30985595	30985596	30985594
	TCMT110208N-...-...	0,5 - 1,5			
	TCGW11				
	TCGW110204F01N-...-...	0,1 - 1,0			
	TCGW110204E01N-...-...	0,1 - 1,0			
	TCGW110208F01N-...-...	0,1 - 1,5			
	TCGW110208E01N-...-...	0,1 - 1,0			
	TCMT16				
	TCMT16T304N-...-...	0,5 - 1,5			30985609
TCMT16T308N-...-...	0,5 - 1,5			30985617	



Wariant z końcówkami, jednostrzowe:

OAA

M				K			N
austenityczny ← odporny na ścieranie		ferrytyczny → ciągliwy		GJL ← odporny na ścieranie		GJS → ciągliwy	
Węglik spiekany				Węglik spiekany		PcBN	PCD
CVD		PVD		CVD		-	-
HC875	HP880	HP885	HP895	HC815	HC825	FU430	PU617
				MKM			
				30985590			
				30985607			
				30985614			
	MGP		MGP	MGP	MGP	OAA	
				30985917			
30985587			30985588	30985586			
30985598		31245563	30985601	30985597			
						30227880	
						30227892	
			30985604	30985602	30985603		
			30985612	30985610	30985611		
		31245564		30985618	30985619		
				30985622	30985623		
	MMM	MMM	MMM	MMM		OAA	OAA
			30985583				
	30985593	31245550	30985594	30985592			
		31245551					
							31279724
						30227878	
						30227890	31279725
		31245552	30985609				
30985616		31245553	30985617				

Podane zakresy ap stanowią wartości zalecane i mogą się różnić w zależności od obrabianego materiału.

TCHT

Płytki skrawające promieniowe, trójkątne, wersja lewa/prawa

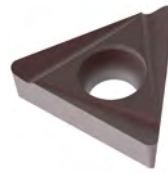

wersja lewa

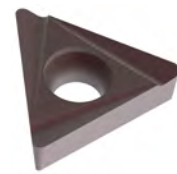

wersja prawa

Materiał obrabiany	K		N
	Węglik spiekany		Węglik spiekany
Podłoże	CVD		PVD
Powłoka	HC740		HP930
Rodzaj materiału skrawającego	HC740		HP930
	HU616		

Wersja ostrza		2L	2L	
TCHT09	a_p max. [mm]			
TCHT090204E04L-...-...	0,5 - 2,5	31317317	30950224	
TCHT090204E04R-...-...	0,5 - 2,5	31317318	30950235	
TCHT090208E04L-...-...	0,5 - 2,5	31317319	30950225	
TCHT090208E04R-...-...	0,5 - 2,5	31317320	30950236	
TCHT11				
TCHT110204E04L-...-...	0,5 - 3,0	31317321	30950226	
TCHT110204E04R-...-...	0,5 - 3,0	31317322	30950237	
TCHT110208E04L-...-...	0,5 - 3,0	31317325	30950227	
TCHT110208E04R-...-...	0,5 - 3,0	31317326	30950238	
TCHT16				
TCHT16T304E04L-...-...	0,5 - 4,0	31317327	30950228	
TCHT16T304E04R-...-...	0,5 - 4,0	31317328	30950239	
TCHT16T308E04L-...-...	0,5 - 4,0	31317340	30950229	
TCHT16T308E04R-...-...	0,5 - 4,0	31317342	30950240	

Wersja ostrza		2L	2R
TCHT06	a_p max. [mm]		
TCHT06T104F01L-...-...	0,1 - 1,0		30492290
TCHT06T104F01R-...-...	0,1 - 1,0		30492307
TCHT06T104E02L-...-...	0,1 - 1,0	30950230	
TCHT06T104E02R-...-...	0,1 - 1,0	30950241	
TCHT09			
TCHT090204F01L-...-...	0,1 - 1,0		30010759
TCHT090204F01R-...-...	0,1 - 1,0		30010777
TCHT090204E02L-...-...	0,1 - 1,0	30950231	
TCHT090204E02R-...-...	0,1 - 1,0	30950242	
TCHT090208E02L-...-...	0,1 - 1,0	30950232	
TCHT090208E02R-...-...	0,1 - 1,0	30950243	
TCHT11			
TCHT110202F01L-...-...	0,1 - 1,5		30010761
TCHT110202F01R-...-...	0,1 - 1,5		30010779
TCHT110204F01L-...-...	0,1 - 1,5		30010762
TCHT110204F01R-...-...	0,1 - 1,5		30010780
TCHT110204E02L-...-...	0,1 - 1,5	30950233	
TCHT110204E02R-...-...	0,1 - 1,5	30950244	
TCHT110208F01L-...-...	0,1 - 1,5		30010763
TCHT110208F01R-...-...	0,1 - 1,5		30478186
TCHT110208E02L-...-...	0,1 - 1,5	30950234	
TCHT110208E02R-...-...	0,1 - 1,5	30950245	
TCHT16			
TCHT16T304F01L-...-...	0,1 - 2,5		30478187
TCHT16T304F01R-...-...	0,1 - 2,5		30478188
TCHT16T308F01L-...-...	0,1 - 2,5		30019882
TCHT16T308F01R-...-...	0,1 - 2,5		30478189

Podane zakresy a_p stanowią wartości zalecane i mogą się różnić w zależności od obrabianego materiału.

TCHT

Płytki skrawające promieniowe, jednostrzowe, wersja neutralna

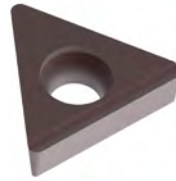

Materiał obrabiany	K		N
Podłoże	Węglik spiekany		Węglik spiekany
Powłoka	CVD	PVD	
Rodzaj materiału skrawającego	HC740	HP930	HU616

Wersja ostrza		1L	1L		
TCHT09 a_p max. [mm]					
Obróbka pośrednia	TCHT090204E04X-...-...	0,5 - 2,5	31319106	30950246	
	TCHT090208E04X-...-...	0,5 - 2,5	31319107	30950247	
	TCHT11				
	TCHT110204E04X-...-...	0,5 - 3,0	31319108	30950248	
	TCHT110208E04X-...-...	0,5 - 3,0	31319109	30950249	
	TCHT16				
	TCHT16T304E04X-...-...	0,5 - 4,0	31039581	30950250	
	TCHT16T308E04X-...-...	0,5 - 4,0	31319140	30950251	

Wersja ostrza			1L	1R	
TCHT06 a_p max. [mm]					
Obróbka wykończeniowa	TCHT06T104F01X-...-...	0,1 - 1,0		30492325	
	TCHT06T104E02X-...-...	0,1 - 1,0	30950252		
	TCHT09				
	TCHT090204F01X-...-...	0,1 - 1,0		30010795	
	TCHT090204E02X-...-...	0,1 - 1,0	30950253		
	TCHT090208E02X-...-...	0,1 - 1,0	30950254		
	TCHT11				
	TCHT110202F01X-...-...	0,1 - 1,5		30010797	
	TCHT110204F01X-...-...	0,1 - 1,5		30010798	
	TCHT110204E02X-...-...	0,1 - 1,5	30950255		
	TCHT110208F01X-...-...	0,1 - 1,5		30010799	
	TCHT110208E02X-...-...	0,1 - 1,5	30950256		
	TCHT16				
	TCHT16T304F01X-...-...	0,1 - 2,5		30019940	
	TCHT16T308F01X-...-...	0,1 - 2,5		30019941	

VCMT | VCGT | VBGW | VCGW

Płytki skrawające promieniowe, dwuostrzowe, wersja neutralna



Materiał obrabiany	P		
	niestopowy ← odporny na ścieranie		stopowy → ciągliwy
Podłoże	Węgiel spiekany		
Powłoka	CVD		PVD
Rodzaj materiału skrawającego	HC850	HC865	HP880
Wersja ostrza		MKM	
VCMT16	a_p max. [mm]		
Obróbka zgrubna			
VCMT160408N-...-...	1,5 - 3,0	30985630	
Wersja ostrza	MGP	MGP	MGP
VCGT11	a_p max. [mm]		
Obróbka pośrednia			
VCGT110304N-...-...	0,25 - 2,0		30966122
VCMT16			
VCMT160404N-...-...	0,5 - 2,0	30966097	30966098
VCMT160408N-...-...	0,75 - 2,0	31093307	30985629
Wersja ostrza			
VBGW16	a_p max. [mm]		
Obróbka wykończeniowa			
VBGW160404E01N-...-...	0,1 - 1,0		
VBGW160408E01N-...-...	0,1 - 1,0		
VCGW16			
VCGW160404E01N-...-...	0,1 - 1,0		
VCGW160408E01N-...-...	0,1 - 1,0		



Wariant z końcówkami,
jednostrzowe:

OAA

	M	K	
	Węglik spiekany	Węglik spiekany	PcBN
	PVD	CVD	-
	HP880	HC815	FU430
	MGP	MGP	
	30966122		
		30985627	
		30985628	
			OAA
			10106686
			10106698
			10106768
			10106780

CCHT | Obróbka mieszana

Płytki skrawające promieniowe, dwustrzowe, obróbka mieszana



wersja prawa



wersja lewa

Materiał obrabiany	N + K		N + P			
	GJL ← odporny na ścieranie		GJS → stopowy ← odporny na ścieranie			
Podłoże	Węglik spiekany		Węglik spiekany			
Powłoka	PVD		PVD			
Rodzaj materiału skrawającego	HP525-P	HP530-P	HP540-P	HP545-P		
Wersja ostrza	1W	1W	1R	1R		
CCHT09	a_p max. [mm]					
Promień	CCHT09T304E02L-...-...	0,1 - 2,0 *	30909374	30909375	30907411	30909351
	CCHT09T304E02R-...-...	0,1 - 2,0	30909376	30909377	30909352	30909353
	CCHT09T308E02L-...-...	0,1 - 2,0	30909378	30909379	30909354	30909355
	CCHT09T308E02R-...-...	0,1 - 2,0	30909380	30909381	30909356	30909357

* W zależności od łożyska oporowego.
Możliwe również wersje do ostrzy specjalnych.

SCHT | Obróbka mieszana

Płytki skrawające promieniowe, czterostrzowe, obróbka mieszana



z promieniem,
wersja lewa

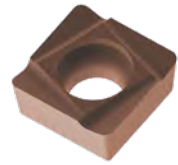

z promieniem,
wersja prawa

Materiał obrabiany	N + K		N + P	
	GJL ← odporny na ścieranie		GJS → niestopowy ← odporny na ścieranie	
Podłoże	Węglik spiekany		Węglik spiekany	
Powłoka	PVD		PVD	
Rodzaj materiału skrawającego	HP525-P	HP530-P	HP540-P	HP545-P

Wersja ostrza		2W	2W	2R	2R	
SHT09		a_p max. [mm]				
Promień	SCHT09T304E02L-...-...	0,1 - 2,0	30909366	30909367	30909345	30909346
	SCHT09T304E02R-...-...	0,1 - 2,0	30909368	30909369	30909347	30909348
	SCHT09T308E02L-...-...	0,1 - 2,0	30909370	30909371	30909349	30909350
	SCHT09T308E02R-...-...	0,1 - 2,0	30909372	30909373	30903215	30907589

CTNQ

Płytki skrawające styczne, czterostrzowe, szlifowane na ostro



Materiał obrabiany	P			M ₁	
	niestopowy odporny na ścieranie			stopowy ciągliwy	
Podłoże	Węglik spiekany			Węglik spiekany	
Powłoka	CVD		PVD		CVD
Rodzaj materiału skrawającego	HC740		HP945	HP950	HC750

Wersja ostrza		H02	H02	H02	A32	
CTNQ od ø 41 mm		a _p max. [mm]				
Obróbka zgrubna	CTNQ090508...L-...	1,5 - 3,0	30933846	30933848	30933849	30950088
		1,5 - 4,0				
	CTNQ090508...R-...	1,5 - 3,0	30933850	30933851	30950091	30950092
		1,5 - 4,0				
	CTNQ090512...L-...	1,5 - 3,0	30933852	30933854	30933855	30950094
		1,5 - 4,0				
	CTNQ090512...R-...	1,5 - 3,0	30933856	30933857	30950097	30950099
		1,5 - 4,0				
	CTNQ od ø 54 mm					
	CTNQ120608...L-...	1,5 - 3,0	30933864	30933866	30933867	
		1,5 - 5,0				
	CTNQ120612...L-...	1,5 - 3,0	30933868	30933869	30980913	
1,5 - 5,0						

Wersja ostrza		A32	A32	A32	A32	
CTNQ od ø 41 mm		a _p max. [mm]				
Obróbka pośrednia	CTNQ090508...L-...	0,5 - 2,0	30933892	30933894	30933895	30950088
	CTNQ090508...R-...	0,5 - 2,0	30933896	30933897	30950112	30950092
	CTNQ090512...L-...	0,5 - 2,0	30933898	30933900	30933901	30950094
	CTNQ090512...R-...	0,5 - 2,0	30933902	30933903	30950118	30950099

M₁ Stal nierdzewnaM₂ Staliwo żaroodporne (materiały na turbosprężarki)Podane zakresy a_p stanowią wartości zalecane i mogą się różnić w zależności od obrabianego materiału.

M₂			K				
austenityczny ← odporny na ścieranie		ferrytyczny → ciągliwy	GJL ← odporny na ścieranie		GJS → ciągliwy	GJL ← odporny na ścieranie	GJS → ciągliwy
Węglik spiekany			Węglik spiekany				
CVD		PVD	CVD		PVD		
HC740	HC750	HP945	HC725	HC740	HP930	HP945	
H02	H02	H02	H02	H02	H02	H02	
30933846	30980873	30933848	30933926	30933846	30933929	30933848	
30933850	30980900	30933851	30933931	30933850	30933934	30933851	
30933852	30980902	30933854	30933936	30933852	30933939	30933854	
30933856	30980905	30933857	30933941	30933856	30933944	30933857	
30933864	30980907	30933866	30933956	30933864	30933959	30933866	
30933868	30980911	30933869	30933961	30933868	30933964	30933869	
A32	A32	A32	A32	A32	A32	A32	
30933892	30950088	30933894	30934005	30933892	30934008	30933894	
30933896	30950092	30933897	30934010	30933896	30934013	30933897	
30933898	30950094	30933900	30934015	30933898	30934018	30933900	
30933902	30950099	30933903	30934020	30933902	30934023	30933903	

CTGQ

Płytki skrawające styczne, czterostrzowe, otwór nieprzelotowy, szlifowane szlifem okrągłym



Materiał obrabiany	P				K			
	niestopowy ← odporny na ścieranie	stopowy → ciągliwy	niestopowy ← odporny na ścieranie	stopowy → ciągliwy	GJL ← odporny na ścieranie	GJS → ciągliwy	GJL ← odporny na ścieranie	GJS → ciągliwy
Podłoże	Węglik spiekany				Węglik spiekany			
Powłoka	CVD		PVD		CVD		PVD	
Rodzaj materiału skrawającego	HC740	HC745	HP945	HP950	HC725	HC740	HP930	HP945

Wersja ostrza		H02	H02	H02	H02	H02	H02	H02	H02	
CTGQ ø 65 mm		a_p max. [mm]								
Obróbka zgrubna	CTGQ090504... LOOB041-...	1,5 - 3,0	31173955	31173956	31173957	31173958				
		1,5 - 4,0					31173959	31173955	31173980	31173957
	CTGQ090508... LOOB041-...	1,5 - 3,0	31173981	31173982	31173983	31173984				
		1,5 - 4,0					31173985	31173981	31173986	31173983
	CTGQ090512... LOOB041-...	1,5 - 3,0	31173987	31184714	31173988	31184715				
		1,5 - 4,0					31173989	31173987	31173990	31173988
	CTGQ ø 78 mm									
	CTGQ120604... LOOB081-...	1,5 - 3,0	31184725	31184726	31184728	31184729				
		1,5 - 5,0					31184724	31184725	31184727	31184728
	CTGQ120608... LOOB081-...	1,5 - 3,0	31173995	31173996	31173997	31173998				
		1,5 - 5,0					31173999	31173995	31174000	31173997
	CTGQ120612... LOOB081-...	1,5 - 3,0	31184731	31184732	31184734	31184735				
	1,5 - 5,0					31184730	31184731	31184733	31184734	

Wersja ostrza		A32	A32	A32	A32	A32	A32	A32	A32	
CTGQ ø 65 mm		a_p max. [mm]								
Obróbka pośrednia	CTGQ090504... LOOB041-...	0,5 - 2,0	31174001	31184716	31174002	31184717	31174003	31174001	31174004	31174002
	CTGQ090508... LOOB041-...	0,5 - 2,0	31174005	31184718	31174006	31184719	31174007	31174005	31174008	31174006
	CTGQ090512... LOOB041-...	0,5 - 2,0	31174009	31184720	31174010	31184721	31174011	31174009	31174012	31174010

CTGQ

Płytki skrawające styczne, czterostrzowe, otwór przelotowy, szlifowane szlifem okrągłym



Materiał obrabiany	P				K					
	niestopowy ← odporny na ścieranie	stopowy → ciągliwy	niestopowy ← odporny na ścieranie	stopowy → ciągliwy	GJL ← odporny na ścieranie	GJS → ciągliwy	GJL ← odporny na ścieranie	GJS → ciągliwy		
Podłoże	Węglik spiekany				Węglik spiekany					
Powłoka	CVD		PVD		CVD		PVD			
Rodzaj materiału skrawającego	HC740	HC745	HP945	HP950	HC725	HC740	HP930	HP945		
Wersja ostrza	H02	H02	H02	H02	H02	H02	H02	H02		
CTGQ od \varnothing 65 mm	a_p max. [mm]									
Obróbka zgrubna	CTGQ090508... L10B041-...	1,5 - 3,0	31174013	31174014	31174015	31174016				
		1,5 - 4,0					31174017	31174013		
	CTGQ od \varnothing 78 mm									
	CTGQ120608... L10B081-...	1,5 - 3,0	31174019	31174020	31174021	31174022				
	1,5 - 5,0					31174023	31174019	31174024	31174021	
Wersja ostrza	A32	A32	A32	A32	A32	A32	A32	A32		
CTGQ od \varnothing 65 mm	a_p max. [mm]									
Obróbka pośrednia	CTGQ090508... L10B041-...	0,5 - 2,0	31174029	31184722	31174031	31184723	31174030	31174029	31174032	31174031

Podane zakresy a_p stanowią wartości zalecane i mogą się różnić w zależności od obrabianego materiału.

CTHQ

Płytki skrawające styczne, czterostrzowe, szlifowane na ostro

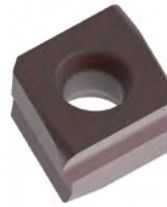

wersja lewa



wersja prawa

Materiał obrabiany	P		M ₁	M ₂		M ₂
				niestopowy ← odporny na ścieranie		stopowy → ciągliwy
Podłoże	Węglik spiekany		Węglik spiekany	Węglik spiekany		Węglik spiekany
Powłoka	CVD	PVD	CVD	CVD		PVD
Rodzaj materiału skrawającego	HC740	HP945	HC750	HC740	HC750	HP945

Wersja ostrza							
CTHQ od ø 28 mm		a _p max. [mm]					
Obróbka zgrubna	CTHQ060408...L-...	1,5 - 2,5					
	CTHQ060408...R-...	1,5 - 2,5					
	Wersja ostrza			A32	H02	H02	H02
	CTHQ od ø 41 mm		a _p max. [mm]				
	CTHQ090508...L-...	1,5 - 3,0		30950084	30980629	30980631	30980632
		1,5 - 4,0					
	CTHQ090508...R-...	1,5 - 3,0		30950086	30980712	30980714	30980751
		1,5 - 4,0					
	CTHQ od ø 54 mm						
	CTHQ120608...L-...	1,5 - 3,0			30980759	30980765	30980766
1,5 - 5,0							
CTHQ120608...R-...	1,5 - 3,0			30980784	30980786	30980787	
	1,5 - 5,0						

Wersja ostrza		A32	A32		A32	A32	A32
CTHQ od ø 28 mm		a _p max. [mm]					
Obróbka pośrednia	CTHQ060404...R-...	0,5 - 2,0					
	CTHQ od ø 41 mm						
	CTHQ090504...L-...	0,5 - 2,0	30933878	30933880		30933878	30980967
	CTHQ090504...R-...	0,5 - 2,0				30980968	
	CTHQ090508...L-...	0,5 - 2,0	30813598	30933885		30813598	30950084
	CTHQ090508...R-...	0,5 - 2,0				30950086	
	CTHQ od ø 54 mm						
	CTHQ120604...L-...	0,5 - 2,0	30933904			30933904	
CTHQ120604...R-...	0,5 - 2,0	30980051			30980051		

M₁ Stal nierdzewnaM₂ Staliwo żaroodporne (materiały na turbosprężarki)

Podane zakresy ap stanowią wartości zalecane i mogą się różnić w zależności od obrabianego materiału.



Warianty z końcówkami, jednostrzowe:

A79, A80

K				N		
GJL ← odporny na ścieranie		GJS → ciągliwy		GJL ← odporny na ścieranie		GJS → ciągliwy
Węglik spiekany				Węglik spiekany		PCD
CVD		PVD		-	PVD	-
HC725	HC740	HP930	HP945	HU616	HP615	PU617
H32	H32	H32	H32			
30933907	30980615	30933910	30980618			
30933912	30980621		30980625			
H02	H02	H02	H02			A80
30921024	30980629	30933917	30980632			30492720
30921023	30980712	30933923	30980751			30515656
30933946	30980759	30933949	30980766			
30933951	30980784	30933954	30980787			
A32	A32	A32	A32	A30	A30	A80
30679873	30942364		30942366	30477914	31010211	
30679874	30933878	30933979	30933880	30492760	31010211	30492764
30679875		30942374		30492770		30515411
30724676	30813598	30933994	30933885	31186236	30610917	
30789885		30942382		31264530	31203830	
30789886	30933904	30934028		30477929		
30789887	30980051	30980054		30477930		

CTHQ

Płytki skrawające styczne, czterostrzowe, otwór nieprzelotowy, szlifowane szlifem okrągłym

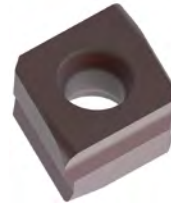

Materiał obrabiany	P				M ₂	
	niestopowy ← odporny na ścieranie	stopowy → ciągliwy	niestopowy ← odporny na ścieranie	stopowy → ciągliwy		
Podłoże	Węglik spiekany				Węglik spiekany	
Powłoka	CVD		PVD		CVD	
Rodzaj materiału skrawającego	HC740	HC745	HP945	HP950	HC750	

Wersja ostrza		A53	A53	A53	A53	A32	
CTHQ od \varnothing 65 mm	a_p max. [mm]						
Obróbka zgrubna	CTHQ090508... L00B041-...	1,5 - 3,0	30933714	30933715	30933716	30933717	30933718
		1,5 - 4,0					
	CTHQ090512... L00B041-...	1,5 - 3,0	30950047				
		1,5 - 4,0					
	CTHQ od \varnothing 78 mm						
	CTHQ120608... L00B081-...	1,5 - 3,0	30933733	30933734			
	1,5 - 5,0						
CTHQ120612... L00B081-...	1,5 - 3,0	30950048					
	1,5 - 5,0						

Wersja ostrza		A32		A32			
CTHQ od \varnothing 40 mm	a_p max. [mm]						
Obróbka pośrednia	CTHQ060404... L00B021-...	0,5 - 2,0					
	CTHQ060404... L00B021-...	0,5 - 2,0					
	CTHQ od \varnothing 65 mm						
	CTHQ090504... L00B041-...	0,5 - 2,0	30950080		30988741		
	CTHQ090508... L00B041-...	0,5 - 2,0	30988732		30988742		
	CTHQ od \varnothing 78 mm						
	CTHQ120604... L00B081-...	0,5 - 2,0					
	CTHQ120608... L00B081-...	0,5 - 2,0	30988734		30988744		

M₂ Staliwo żaroodporne (materiały na turbosprężarki)

Podane zakresy a_p stanowią wartości zalecane i mogą się różnić w zależności od obrabianego materiału.



Wariant z końcówkami,
jednostrzowe:

A79, A80

K				N	
GJL ← odporny na ścieranie		GJS → ciągliwy		GJL ← odporny na ścieranie	
Węglik spiekany				Węglik spiekany	
CVD		PVD		-	
HC725	HC740	HP930	HP945	HU616	PU617
H02	H02	H02	H02		A80
30933721	30988707	30933724	30988736		30492584
30933727	30988708	30933730	30988737		
30933735	30988709	30933738	30988738		
	30988730		30988739		
A32	A32	A32	A32	A30	A80
30679863	30988748	30933807	30988753	30477915	30492616
30679858	30950080	30933756	30988741	30328643	
30679859	30988732	30933765	30988742	30307194	30492584
30789881	31322355	31322356	31322357	30477928	
30789882	30988734	30933777	30988744	30477931	31213527

CTHQ

Płytki skrawające styczne, czterostrzowe, otwór przelotowy, szlifowane szlifem okrągłym

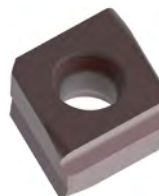

Materiał obrabiany	P				M ₂		
	niestopowy ← odporny na ścieranie	stopowy → ciągliwy	niestopowy ← odporny na ścieranie	stopowy → ciągliwy			
Podłoże	Węglik spiekany				Węglik spiekany		
Powłoka	CVD		PVD		CVD		
Rodzaj materiału skrawającego	HC740	HC745	HP945	HP950	HC750		
Wersja ostrza	A53	A53	A53	A53	A32		
CTHQ od ø 65 mm	a_p max. [mm]						
Obróbka zgrubna	CTHQ090508... L10B041-...	1,5 - 3,0	30933783	30933784	30933785	30933786	30933787
		1,5 - 4,0					
	CTHQ od ø 78 mm						
Obróbka zgrubna	CTHQ120608... L10B081-...	1,5 - 3,0	30950082				
		1,5 - 5,0					
Wersja ostrza	A32		A32				
CTHQ od ø 40 mm	a_p max. [mm]						
Obróbka pośrednia	CTHQ060408... L10B021-...	0,5 - 2,0					
	CTHQ od ø 65 mm						
Obróbka pośrednia	CTHQ090508... L10B041-...	0,5 - 2,0	30988749		30988755		
	CTHQ od ø 78 mm						
Obróbka pośrednia	CTHQ120608... L10B081-...	0,5 - 2,0	30988750		30988756		

M₂ Staliwo żaroodporne (materiały na turbosprężarki)

Podane zakresy a_p stanowią wartości zalecane i mogą się różnić w zależności od obrabianego materiału.



Warianty z końcówkami,
jednostrzowe:

A79, A80

K				N	
GJL ← odporny na ścieranie		GJS → GJL ciągliwy ← odporny na ścieranie		GJS → ciągliwy	
Węglík spiekany				Węglík spiekany	
CVD		PVD		-	
HC725	HC740	HP930	HP945	HU616	PU617
H02	H02	H02	H02		A80
30933790	30988746	30933793	30988751		30492657
30933796	30988747	30933799	30988752		
A32	A32	A32	A32	A30	A80
30679863	30988748	30933807	30988753	30477916	
30679865	30988749	30933825	30988755	30307197	30492657
	30988750		30988756	30477932	

FTNQ

Płytki skrawające styczne, czterostrzowe, szlifowane na ostro

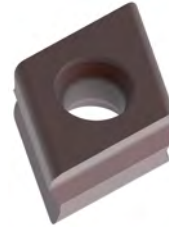

Materiał obrabiany	P		M ₁	M ₂	
				austenityczny odporny na ścieranie	ferrytyczny ciągliwy
Podłoże	Węglik spiekany		Węglik spiekany	Węglik spiekany	
Powłoka	CVD	PVD	CVD	CVD	
Rodzaj materiału skrawającego	HC740	HP945	HC750	HC740	HC750

Wersja ostrza	H02	H02	A32	H02	H02
---------------	-----	-----	-----	-----	-----

FTNQ od ø 30 mm		a _p max. [mm]						
Obróbka zgrubna	FTNQ090508...L-...	1,5 - 3,0	30934169	30934170	30934171	30934169	30980508	
		1,5 - 4,0						
	FTNQ od ø 40 mm							
	FTNQ120608...L-...	1,5 - 3,0	30934188	30934189		30934188	30980523	
		1,5 - 5,0						
	FTNQ120608...R-...	1,5 - 3,0	30934196	30934197		30934196		
1,5 - 5,0								

Wersja ostrza	A32	A32		A32	A32
---------------	-----	-----	--	-----	-----

FTNQ od ø 30 mm		a _p max. [mm]						
Obróbka pośrednia	FTNQ090508...L-...	0,5 - 2,0	30934222	30934223		30934222	30934171	
		0,5 - 2,0						

M₁ Stal nierdzewnaM₂ Staliwo żaroodporne (materiały na turbosprężarki)

Podane zakresy ap stanowią wartości zalecane i mogą się różnić w zależności od obrabianego materiału.

M ₂		K			
		GJL ← odporny na ścieranie		GJS → ciągliwy	
		GJL ← odporny na ścieranie		GJS → ciągliwy	
Węglík spiekany		Węglík spiekany			
PVD		CVD		PVD	
HP945		HC725	HC740	HP930	HP945
H02		H02	H02	H02	H02
30934170					
		30934173	30934169	30934175	30934170
30934189					
		30934192	30934188	30934194	30934189
30934197					
		30934198	30934196	30934200	30934197
A32		A32	A32	A32	A32
30934223					
		30934173	30934222	30934175	30934223

FTGQ

Płytki skrawające styczne, czterostrzowe, otwór nieprzelotowy, szlifowane szlifem okrągłym



Materiał obrabiany	P				K			
	niestopowy ← odporny na ścieranie	stopowy → ciągliwy	niestopowy ← odporny na ścieranie	stopowy → ciągliwy	GJL ← odporny na ścieranie	GJS → ciągliwy	GJL ← odporny na ścieranie	GJS → ciągliwy
Podłoże	Węglik spiekany				Węglik spiekany			
Powłoka	CVD		PVD		CVD		PVD	
Rodzaj materiału skrawającego	HC740	HC745	HP945	HP950	HC725	HC740	HP930	HP945

Wersja ostrza		H02	H02	H02	H02	H02	H02	H02	H02	
FTGQ od \varnothing 30 mm		a_p max. [mm]								
Obróbka zgrubna	FTGQ090504...L00B016- ...	1,5 - 3,0	31174033	31174034	31174035	31174036				
		1,5 - 4,0					31174037	31174033	31174038	31174035
	FTGQ090508...L00B016- ...	1,5 - 3,0	31174039	31174040	31174041	31174042				
		1,5 - 4,0					31174043	31174039	31174044	31174041
	FTGQ090512...L00B016- ...	1,5 - 3,0	31184737	31184738	31184740	31184741				
		1,5 - 4,0					31184736	31184737	31184739	31184740
	FTGQ od \varnothing 40 mm									
	FTGQ120604...L00B021- ...	1,5 - 3,0	31184755	31184756	31184758	31184759				
		1,5 - 5,0					31184754	31184755	31184757	31184758
	FTGQ120608...L00B021- ...	1,5 - 3,0	31174045	31174046	31174047	31174048				
		1,5 - 5,0					31174049	31174045	31174050	31174047
	FTGQ120612...L00B021- ...	1,5 - 3,0	31184761	31184762	31184764	31184765				
	1,5 - 5,0					31184760	31184761	31184763	31184764	

Wersja ostrza		A32	A32	A32	A32	A32	A32	A32	A32	
FTGQ od \varnothing 30 mm		a_p max. [mm]								
Obróbka pośrednia	FTGQ090504...L00B016- ...	0,5 - 2,0	31174051	31184742	31174053	31184743	31174052	31174051	31174054	31174053
	FTGQ090508...L00B016- ...	0,5 - 2,0	31174055	31184744	31174057	31184745	31174056	31174055	31174058	31174057
	FTGQ090512...L00B016- ...	0,5 - 2,0	31184747	31184748	31184750	31184751	31184746	31184747	31184749	31184750

FTGQ

Płytki skrawające styczne, czterostrzowe, otwór przelotowy, szlifowane szlifem okrągłym



Materiał obrabiany	P				K				
	niestopowy ← odporny na ścieranie	stopowy → ciągliwy	niestopowy ← odporny na ścieranie	stopowy → ciągliwy	GJL ← odporny na ścieranie	GJS → ciągliwy	GJL ← odporny na ścieranie	GJS → ciągliwy	
Podłoże	Węglik spiekany				Węglik spiekany				
Powłoka	CVD		PVD		CVD		PVD		
Rodzaj materiału skrawającego	HC740	HC745	HP945	HP950	HC725	HC740	HP930	HP945	
Wersja ostrza	H02	H02	H02	H02	H02	H02	H02	H02	
FTGQ od ø 30 mm	a_p max. [mm]								
Obróbka zgrubna	FTGQ090508...L10B016-	1,5 - 3,0	31174059	31174060	31174061	31174062			
	...	1,5 - 4,0					31174063	31174059	31174065
	FTGQ od ø 40 mm								
	FTGQ120608...L10B021-	1,5 - 3,0	31174066	31174067	31174068	31174069			
...	1,5 - 5,0					31174070	31174066	31174071	31174068
Wersja ostrza	A32	A32	A32	A32	A32	A32	A32	A32	
FTGQ od ø 30 mm	a_p max. [mm]								
Obróbka pośrednia	FTGQ090508...L10B016-	0,5 - 2,0	31174076	31184752	31174078	31184753	31174077	31174076	31174079
	...								31174078

Podane zakresy a_p stanowią wartości zalecane i mogą się różnić w zależności od obrabianego materiału.

FTHQ

Płytki skrawające styczne, czterostrzowe, szlifowane na ostro

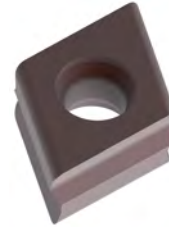

Materiał obrabiany	P		M ₁		
			austenityczny → odporny na ścieranie ← ferrytyczny → ← ciągliwy →		
Podłoże	Węgiel spiekany		Węgiel spiekany		
Powłoka	CVD	PVD	CVD	PVD	
Rodzaj materiału skrawającego	HC740	HP945	HC750	HC740	HC750

Wersja ostrza		A53	A53	A32	H02	H02	
FTHQ od ø 30 mm		a _p max. [mm]					
Obróbka zgrubna	FTHQ090508...L-...	1,5 - 3,0	30980167	30934159	30934160	30912756	30980484
		1,5 - 4,0					
	FTHQ090508...R-...	1,5 - 3,0	30934166	30934167	30950130	30980488	
		1,5 - 4,0					
	FTHQ od ø 40 mm						
	FTHQ120608...L-...	1,5 - 3,0	30934177	30934178	30934179	30980491	30980493
	1,5 - 5,0						
FTHQ120608...R-...	1,5 - 3,0	30934185	30934186	30950135	30980501		
	1,5 - 5,0						

Wersja ostrza		A32	A32		A32	A32	
FTHQ od ø 22 mm		a _p max. [mm]					
Obróbka pośrednia	FTHQ060404...L-...	0,5 - 1,5					
	FTHQ060404...R-...	0,5 - 1,5					
	FTHQ060408...L-...	0,5 - 1,5					
	FTHQ060408...R-...	0,5 - 1,5					
	FTHQ od ø 30 mm						
	FTHQ090504...L-...	0,5 - 2,0					
	FTHQ090504...R-...	0,5 - 2,0					
	FTHQ090508...L-...	0,5 - 2,0	30934214	30934215		30934214	30934160
	FTHQ090508...R-...	0,5 - 2,0					30950130
	FTHQ od ø 40 mm						
	FTHQ120604...L-...	0,5 - 2,0					
	FTHQ120604...R-...	0,5 - 2,0					
	FTHQ120608...L-...	0,5 - 2,0	30934231	30934232		30934231	30934179
	FTHQ120608...R-...	0,5 - 2,0					30950135

M₁ Stal nierdzewnaM₂ Staliwo żaroodporne (materiały na turbosprężarki)

Podane zakresy ap stanowią wartości zalecane i mogą się różnić w zależności od obrabianego materiału.

FTHQ

Płytki skrawające styczne, czterostrzowe, otwór nieprzelotowy, szlifowane szlifem okrągłym

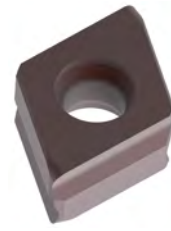

Materiał obrabiany	P				M	
	niestopowy ← odporny na ścieranie	stopowy → ciągliwy	niestopowy ← odporny na ścieranie	stopowy → ciągliwy	austenityczny ← odporny na ścieranie	ferrytyczny → ciągliwy
Podłoże	Węglik spiekany				Węglik spiekany	
Powłoka	CVD		PVD		CVD	
Rodzaj materiału skrawającego	HC740		HP945		HC750	
Wersja ostrza	A53		A53		A32	
FTHQ od \varnothing 30 mm	a_p max. [mm]					
Obróbka zgrubna	FTHQ090508... L00B016-...	1,5 - 3,0	30980181	30934058	30934059	
		1,5 - 4,0				
	FTHQ090512...L00B016- ...	1,5 - 3,0	30934075	30934076		
		1,5 - 4,0				
	FTHQ od \varnothing 40 mm					
	FTHQ120608... L00B021-...	1,5 - 3,0	30934081	30934082		
	1,5 - 5,0					
FTHQ120612...L00B021- ...	1,5 - 3,0	30934087	30934088			
	1,5 - 5,0					
Wersja ostrza	A32					
FTHQ od \varnothing 22 mm	a_p max. [mm]					
Obróbka pośrednia	FTHQ060404...L00B012-...	0,5 - 1,5				
	FTHQ060408...L00B012-...	0,5 - 1,5				
	FTHQ od \varnothing 30 mm					
	FTHQ090504...L00B016-...	0,5 - 2,0	30950123			
	FTHQ090508...L00B016-...	0,5 - 2,0	30901249			
	FTHQ od \varnothing 40 mm					
	FTHQ120604...L00B021-...	0,5 - 2,0				
	FTHQ120608...L00B021-...	0,5 - 2,0	30934113			
FTHQ120612...L00B021-...	0,5 - 2,0					



Wariant z końcówkami,
jednoostrzowe:

A79, A80

K		K		N		
GJL ← odporny na ścieranie		GJS → ciągliwy	GJL ← odporny na ścieranie		GJS → ciągliwy	
Węglík spiekany CVD		Węglík spiekany PVD		Węglík spiekany	PCD	
HC725	HC740	HP930	HP945	HU616	PU617	
H02	H02	H02	H02		A80	
30934071	30934057	30934073	30988760		30492784	
30934077	30988757	30934079	30988761			
30934083	30988758	30934085	30988762			
30934089	30988759	30934091	30988763			
A32	A32	A32	A32	A30	A79	A80
30679879	30950121	30934095	30988764	30477935		
30679880	30950122	30934099	30988765	30477936	30492816	
30679881	30950123	30934103	30988766	30477942		
30679882	30901249	30934111	30934106	30478043		30492784
30934115	30934113	30934118	30934114	30477950		
				30477952		
				30492842		

FTHQ

Płytki skrawające styczne, czterostrzowe, otwór przelotowy, szlifowane szlifem okrągłym

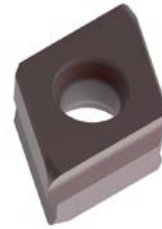

Materiał obrabiany	P		M	K		
	Węglik spiekany		Węglik spiekany	Węglik spiekany		
Podłoże	Węglik spiekany		Węglik spiekany	Węglik spiekany		
Powłoka	CVD	PVD	CVD	CVD		
Rodzaj materiału skrawającego	HC740	HP945	HC750	HC725	HC740	
Wersja ostrza	A53	A53	A32	H02	H02	
FTHQ od \varnothing 30 mm	a_p max. [mm]					
Obróbka zgrubna	FTHQ090508...L10B016- ...	1,5 - 3,0	30934120	30934121	30934122	
		1,5 - 4,0				30934124 30988767
	FTHQ od \varnothing 40 mm					
	FTHQ120608...L10B021- ...	1,5 - 3,0	30934128	30934129		
	1,5 - 5,0				30934130 30988768	
Wersja ostrza	A32	A32		A32	A32	
FTHQ od \varnothing 22 mm	a_p max. [mm]					
Obróbka pośrednia	FTHQ060408... L10B012-...	0,5 - 1,5				30679886 30942386
	FTHQ od \varnothing 30 mm					
	FTHQ090508... L10B016-...	0,5 - 2,0	30942389	30942390		30679888 30942389
	FTHQ od \varnothing 40 mm					
FTHQ120608... L10B021-...	0,5 - 2,0	30942391	30942392		30789889 30942391	



Wariant z końcówkami,
jednoostrzowe:

A79, A80

K		N		
GJL ← odporny na ścieranie		GJS → ciągliwy		
Węglik spiekany		Węglik spiekany		PCD
PVD		-		-
HP930	HP945	HU616		PU617
H02	H02			A80
30934126	30988769			30492850
30934132	30988770			30668155
A32	A32	A30	A79	A80
30942394	30942388	30477937	30492868	
30942397	30942390	30477944		30492850
30942400	30942392	30477953		30668155

STHD – STHE

Płytki skrawające styczne, czterostrzowe, z fazą, wersja neutralna

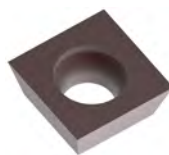
Wariant z końcówkami,
jednostrzowe:

D80

Materiał obrabiany	M ₂	K		N	
Podłoże	Węglík spiekany	Węglík spiekany		Węglík spiekany	PCD
Powłoka	PVD	CVD	PVD	-	-
Rodzaj materiału skrawającego	HP930	HC725	HP930	HU616	PU617



Wersja ostrza		D02	D02	D02	D00	D80	
STH_06		a _p max. [mm]					
Fazy	STHD060300...N-...	0,1 - 4,2	30950141	30774242	30950141	30213884	30493003
	STHE060300...N-...	0,1 - 4,2	30950142	30789899	30950142	30228119	30370122
	STH_09						
	STHD09T300...N-...	0,1 - 6,3	30950143	30631370	30950143	30215016	30493005
	STHE09T300...N-...	0,1 - 6,3	30950144	30631351	30950144	30257365	30493006

M₂ Staliwo żaroodporne (materiały na turbosprężarki)

Podane zakresy ap stanowią wartości zalecane i mogą się różnić w zależności od obrabianego materiału.

Notatki







Osprzęt do narzędzi z płytkami skrawającymi stycznymi

WSP	Wielkość WSP	Śruba mocująca					Wkrętak
		Wymiar [MxI]	Opis	Moment dokręcenia [Nm]	Wielkość TORX®	Nr materiałowy	Nr materiałowy
CT... 	0604	M2.5 x 8.7	MN659 M2.5x8.7-TX8-IP	1	TX8-IP	30533284	30414760
	0905	M3.5 x 11	MN659 M3.5x11-TX10-IP	2,8	TX10-IP	10105079	30414763
	1206	M5 x 14	MN659 M5x14-TX20-IP	7,5	TX20-IP	10006485	30414766
FT... 	0604	M2.5 x 8.7	MN659 M2.5x8.7-TX8-IP	1	TX8-IP	30533284	30414760
	0905	M3.5 x 11	MN659 M3.5x11-TX10-IP	2,8	TX10-IP	10105079	30414763
	1206	M5x14	MN659 M5x14-TX20-IP	7,5	TX20-IP	10006485	30414766
ST... 	0603	M2.5 x 6	MN659 M2.5x6-TX8-IP	1	TX8-IP	10105073	30414760
	09T3	M3.5x9	MN659 M3.5x9-TX15-IP	2,8	TX15-IP	10105078	30414764

Pasta do smarowania połączeń śrubowych, do wysokich temperatur

Pasta ceramiczna / zgrzewana tuba PE 30 g	30861389	
---	----------	--

Osprzęt do narzędzi z płytkami skrawającymi promieniowymi

WSP	Wielkość WSP	Śruba mocująca					Wkrętak
		Wymiar [MxI]	Opis	Moment dokręcenia [Nm]	Wielkość TORX®	Nr materiałowy	Nr materiałowy
CC... 	0602	M2.5 x 6	MN659 M2.5x6-TX8-IP	1	TX8-IP	10105073	30414760
	09T3	M3.5 x 9	MN659 M3.5x9-TX15-IP	2,8	TX15-IP	10105078	30414764
	1204	M5 x 11	MN659 M5x11-TX20-IP	7,5	TX20-IP	10105082	30414766
DC... 	0702	M2.5 x 6	MN659 M2.5x6-TX8-IP	1	TX8-IP	10105073	30414760
	11T3	M3.5 x 9	MN659 M3.5x9-TX15-IP	2,8	TX15-IP	10105078	30414764
	1504	M5x11	MN659 M5x11-TX20-IP	7,5	TX20-IP	10105082	30414766
SP... 	0603	M2.5 x 6	MN659 M2.5x6-TX8-IP	1	TX8-IP	10105073	30414760
TC... 	06T1	M2 x 4.95	MN659 M2x4.95-TX6-IP	0,5	TX6-IP	10002712	30414758
	0902	M2.2 x 5.5	MN659 M2.2x5.5-TX7-IP	0,8	TX7-IP	10105070	30414759
	1102	M2.5 x 6	MN659 MN2.5x6-TX8-IP	1	TX8-IP	10105073	30414760
	16T3	M3.5 x 9	MN659 M3.5x9-TX15-IP	2,8	TX15-IP	10105078	30414764
	2204	M5x11	MN659 M5x11-TX20-IP	7,5	TX20-IP	10105082	30414766
SC... 	09T3	M3.5 x 9	MN659 M3.5x9-TX15-IP	2,8	TX15-IP	10105078	30414764
	1204	M5 x 11	MN659 M5x11-TX20-IP	7,5	TX20-IP	10105082	30414766
VB-/VC... 	1103	M2.5 x 6	MN659 MN2.5x6-TX8-IP	1	TX8-IP	10105073	30414760
	1604	M3.5 x 9	MN659 M3.5x9-TX15-IP	2,8	TX15-IP	10105078	30414764

Zalecane parametry skrawania dla pogłębiaczy z płytkami skrawającymi (1/2)

Prędkość skrawania [m/min]

MZG*	Materiał obrabiany		Wytrzymałość/twardość [N/mm ²] [HRC]	Cermet		PcBN		
				z powłoką CVD	z powłoką PVD	bez powłoki		
				CC112	CP872	FU430		HC725
P	P1	P1.1	Stale konstrukcyjne, użytkowe i uszlachetnione, stale niestopowe	< 700	160-600	200-300		
		P1.2	Stale konstrukcyjne, użytkowe i uszlachetnione, stale niestopowe	< 1 200	160-500			
	P2	P2.1	Stale azotowane, użytkowe i uszlachetnione, stale stopowe	< 900	160-600	120-220		
		P2.2	Stale azotowane, użytkowe i uszlachetnione, stale stopowe	< 1 400	140-400			
	P3	P3.1	Stale narzędziowe, łożyskowe, sprężynowe i stale szybkoobrotowe**	< 800	160-600	120-220		
		P3.2	Stale narzędziowe, łożyskowe, sprężynowe i stale szybkoobrotowe**	< 1 000	140-400			
		P3.3	Stale narzędziowe, łożyskowe, sprężynowe i stale szybkoobrotowe**	< 1 500				
	P4	P4.1	Stale narzędziowe, łożyskowe, sprężynowe i stale szybkoobrotowe**		140-400			
P5	P5.1	Stale nierdzewne, ferrytyczne i martenzytyczne		140-400				
P6	P6.1	Staliwo		140-400				
M	M1	M1.1	Staliwo nierdzewne, ferrytyczne i martenzytyczne	< 700	100-500			
		M1.2	Stale nierdzewne, ferrytyczne/austenityczne (Duplex)	< 1 000	100-450			
	M2	M2.1	Staliwo nierdzewne, austenityczne	< 700	100-500			
	M3	M3.1	Staliwo nierdzewne, ferrytyczne/austenityczne (Duplex)	< 1 000	100-450			
K	K1	K1.1	Żeliwo z grafitem płatkowym (żeliwo szare), GJL	< 300			400-1000	140-300
		K2.1	Żeliwo sferoidalne, GJS	< 500			350-800	120-260
	K2	K2.2	Żeliwo sferoidalne, GJS	≤ 800				120-220
		K2.3	Żeliwo sferoidalne, GJS	> 800				80-140
	K3	K3.1	Żeliwo wermikularne, GJV, (żeliwo ciągliwe), GJL	< 500				80-130
		K3.2	Żeliwo wermikularne, GJV, (żeliwo ciągliwe), GJL	> 500				80-120
N	N1	N1.1	Aluminium, niestopowe i stopowe < 3 % Si					
		N1.2	Aluminium, stopowe ≤ 7 % Si					
		N1.3	Aluminium, stopowe > 7-12 % Si					
		N1.4	Aluminium, stopowe > 12 % Si					
	N2	N2.1	Miedź, niestopowa i niskostopowa	< 300				
		N2.2	Miedź, stopowa	> 300				
		N2.3	Mosiądz, brąz, spisz	< 1 200				
	N3	N3.1	Grafit, > 8 μm	< 1 200				
		N3.2	Grafit, ≤ 8 μm					
	N4	N4.1	Tworzywo sztuczne, materiały termoplastyczne					
N4.2		Tworzywo sztuczne, duroplast						
N4.3		Tworzywo sztuczne, pianki						
K+K	K1.1, K1.2	Obróbka mieszana żeliwa (GJL i GJS)						
K+P	K1.1, spieki	Obróbka mieszana żeliwa i stali spiekanej						
N+K	N1.2, K1.1	N1.2, K1.1	Obróbka mieszana aluminium i żeliwa (GJL)					
		N1.2, K1.2	Obróbka mieszana aluminium i żeliwa (GJS)					
N+P	N1.2, spieki	Obróbka mieszana aluminium i stali spiekanej						

* Grupa materiałowa wg MAPAL

** Jeśli składniki stopu Cr, Mo, Ni, V, W wynoszą łącznie > 8%, należy wybrać następną w kolejności grupę materiałową MAPAL.

Zalecane parametry skrawania dla pogłębiaczy z płytkami skrawającymi (2/2)

Prędkość skrawania [m/min]

MZG*	Materiał obrabiany		Wytrzymałość/twardość [N/mm ²] [HRC]	z powłoką PVD				
				HP615	HP880	HP885	HP895	
P	P1	P1.1	Stale konstrukcyjne, użytkowe i uszlachetnione, stale niestopowe	< 700		100-220		100-220
		P1.2	Stale konstrukcyjne, użytkowe i uszlachetnione, stale niestopowe	< 1 200		100-220		100-220
	P2	P2.1	Stale azotowane, użytkowe i uszlachetnione, stale stopowe	< 900		100-220		100-220
		P2.2	Stale azotowane, użytkowe i uszlachetnione, stale stopowe	< 1 400		100-200		100-200
	P3	P3.1	Stale narzędziowe, łożyskowe, sprężynowe i stale szybko tnące**	< 800		80-200		80-200
		P3.2	Stale narzędziowe, łożyskowe, sprężynowe i stale szybko tnące**	< 1 000		80-200		80-200
		P3.3	Stale narzędziowe, łożyskowe, sprężynowe i stale szybko tnące**	< 1500				
	P4	P4.1	Stale narzędziowe, łożyskowe, sprężynowe i stale szybko tnące**			80-200		80-200
P5	P5.1	Stale nierdzewne, ferrytyczne i martenzytyczne			80-200		80-200	
P6	P6.1	Staliwo						
M	M1	M1.1	Staliwo nierdzewne, ferrytyczne i martenzytyczne	< 700		150-220	100-180	150-220
		M1.2	Stale nierdzewne, ferrytyczne/austenityczne (Duplex)	< 1 000		120-200	100-160	120-200
	M2	M2.1	Staliwo nierdzewne, austenityczne	< 700		100-180	80-150	100-180
	M3	M3.1	Staliwo nierdzewne, ferrytyczne/austenityczne (Duplex)	< 1 000		100-180	60-140	100-180
K	K1	K1.1	Żeliwo z grafitem płatkowym (żeliwo szare), GJL	< 300				
		K2.1	Żeliwo sferoidalne, GJS	< 500				
		K2.2	Żeliwo sferoidalne, GJS	≤ 800				
	K3	K2.3	Żeliwo sferoidalne, GJS	> 800				
		K3.1	Żeliwo wermikularne, GJV, (żeliwo ciągliwe), GJL	< 500				
		K3.2	Żeliwo wermikularne, GJV, (żeliwo ciągliwe), GJL	> 500				
N	N1	N1.1	Aluminium, niestopowe i stopowe < 3 % Si		150-600			
		N1.2	Aluminium, stopowe ≤ 7 % Si		100-500			
		N1.3	Aluminium, stopowe > 7-12 % Si		100-400			
		N1.4	Aluminium, stopowe > 12 % Si					
	N2	N2.1	Miedź, niestopowa i niskostopowa	< 300	100-350			
		N2.2	Miedź, stopowa	> 300	100-300			
		N2.3	Mosiądz, brąz, spiż	< 1 200	100-250			
	N3	N3.1	Grafit, > 8 μm	< 1 200				
		N3.2	Grafit, ≤ 8 μm					
	N4	N4.1	Tworzywo sztuczne, materiały termoplastyczne					
N4.2		Tworzywo sztuczne, duroplast						
N4.3		Tworzywo sztuczne, pianki						
K1+K2	K1.1, K1.2	Obróbka mieszana żeliwa (GJL i GJS)						
K+P	K1.1, spieki	Obróbka mieszana żeliwa i stali spiekanej						
N+K	N1.2, K1.1	Obróbka mieszana aluminium i żeliwa (GJL)						
	N1.2, K1.2	Obróbka mieszana aluminium i żeliwa (GJS)						
N+P	N1.2, spieki	Obróbka mieszana aluminium i stali spiekanej						

* Grupa materiałowa wg MAPAL

** Jeśli składniki stopu Cr, Mo, Ni, V, W wynoszą łącznie > 8%, należy wybrać następną w kolejności grupę materiałową MAPAL.

Węglik spiekany							PCD			
			z powłoką CVD, obróbka mieszana				bez powłoki	bez powłoki		
HP930	HP945	HP950	HP525-P	HP530-P	HP540-P	HP545-P	HU616	PU617	PU660	PU670
	100-180	100-160								
	100-180	100-160								
	100-180	100-160								
	80-150	80-150								
	100-180	100-160								
	80-130	90-130								
	80-130	90-130								
	80-130	90-130								
	80-130	90-130								
	70-120	70-120								
140-220	120-200									
120-200	120-180									
120-180	120-180									
80-140	80-120									
60-130	60-100									
60-120	60-100									
							150-500	450-2200	450-2200	410-1980
							100-450	400-1700	400-1700	360-1530
							100-400	350-1300	350-1300	320-1170
								200-800	200-800	180-720
							100-250	250-600	250-600	230-540
							100-220	200-600	200-600	180-540
							80-220	200-500	200-500	180-450
							120-480	300-600	300-600	270-540
							250-500	400-1000	400-1000	360-900
							250-500	400-1000	400-1000	360-900
			120-220	120-220	120-200					
				120-200	120-200	110-200				
			120-300	120-300	120-230					
			120-280	120-280	120-230					
				120-220	120-230	110-200				

Podane wartości robocze to wartości orientacyjne.
 Optymalne wartości dla danego przypadku obróbki należy ustalić w ramach próby lub podczas obróbki.



ANEKS TECHNICZNY

Informacje dotyczące zastosowania, obsługi i danych skrawania



59.5
Antriebsauslastung - Anzeige
X1 Y1 Z1 C1 B1 SPM1 U1
01/07 Service Info
DATE: 03.04.11 TIME: 18:20:25 (24.7)
MEL 4 Betriebsart aktiv
NC/UKS/4_1471_SPM1_STANDARDPROG/SPM1_2_2
782812
RESET UKS
Position [mm]
X 226.533
Y 33.867
Z 46.362
C 0.000°
B 0.000°
G55
TFS
T SPM1_STANDARD D1
F SPM1_STANDARD R0.000 L137.758
S1 Master 0 mm/min 0.0%
100%
Zoom Istwert
T.S.M NPU setzen Nullp. Werkst. Werkz. messen Position Planfräsen Schwenken

ANEKS TECHNICZNY

Wiercenie w pełnym materiale

Informacje dotyczące zastosowania	
Wiertła z wymienną głowicą TTD-Tritan	740
Wiercenie głębokich otworów	742
Wiertła z płytkami skrawającymi	744
Informacje dotyczące obsługi	
Wiertła z płytkami skrawającymi QTD	746
Wiertła z wymienną głowicą TTD	748
Wiertła z wymienną głowicą TTD-Tritan	750

Rozwiercanie i rozwiercanie precyzyjne

Geometrie nakroju i kąty natarcia	752
Informacje dotyczące obsługi	
System HFS	754
HPR400 i HPR400 plus	756
Rozwiertaki jednostrzowe	758
System EasyAdjust	760
Wyszukiwanie i rozwiązywanie problemów	764

Nawiercanie i toczenie

Objaśnienie pojęć i wzory	766
Wartości orientacyjne minimalnych średnic nawiercania	770
Wyszukiwanie i rozwiązywanie problemów	
Postacie zużycia płytek skrawających	772
Od praktyków – dla praktyków	773

Informacje dotyczące zastosowania wiertel z wymienną głowicą TTD-Tritan

Trójstrzowe wiertło z wymienną głowicą TTD-Tritan gwarantuje optymalne przenoszenie momentu obrotowego na złącze przy jednoczesnej wysokiej dokładności przezbrajania i niskiej wartości bicia. Wymiana głowicy przebiega szybko i stabilnie, co zapobiega jej nieprawidłowemu pozycjonowaniu. Do narzędzia dołączony jest pasujący klucz TORX® z rękojeścią, dzięki czemu możliwe jest precyzyjne zamocowanie wymiennej głowicy w uchwycie przy użyciu śruby mocującej specjalnej.

Stan chłodziwa:

Ciśnienie chłodziwa w zależności od głębokości wiercenia: 3xD: 8 bar | 5xD: 12 bar



Maksymalny kąt wejścia i wyjścia:

Przy nawiercaniu i wychodzeniu z otworu na ukośnych powierzchniach zmniejszyć v_f o 50%.

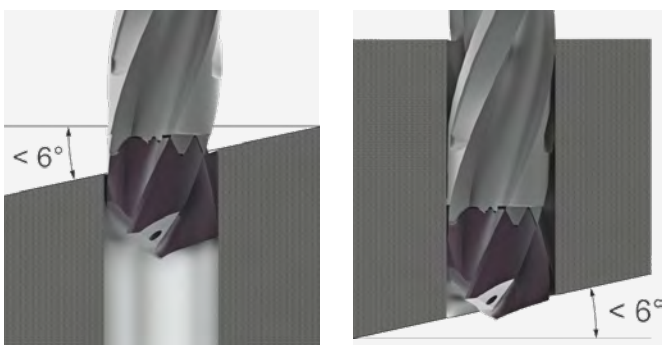

Otwór przelotowy:

Przy wychodzeniu z otworu nie jest zalecane obniżanie parametrów skrawania.

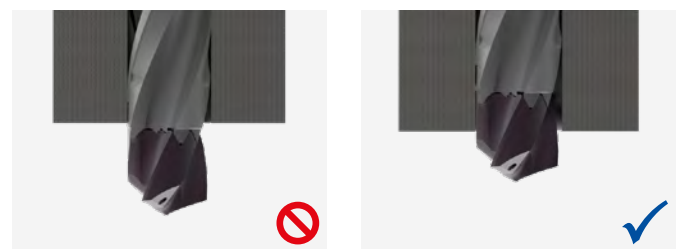

Wartość bicia:

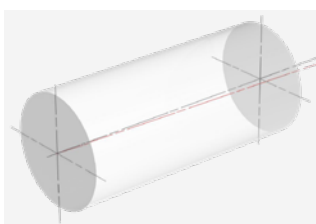

Maks. 0,02 mm

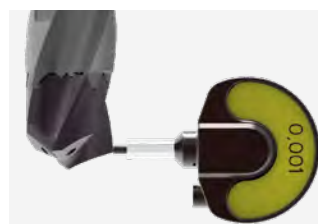

Maks. 0,04 mm

Nie śpieszyć się z wycofywaniem wiertła:

Prędkość wycofywania powinna wynosić pięciokrotność prędkości posuwu.

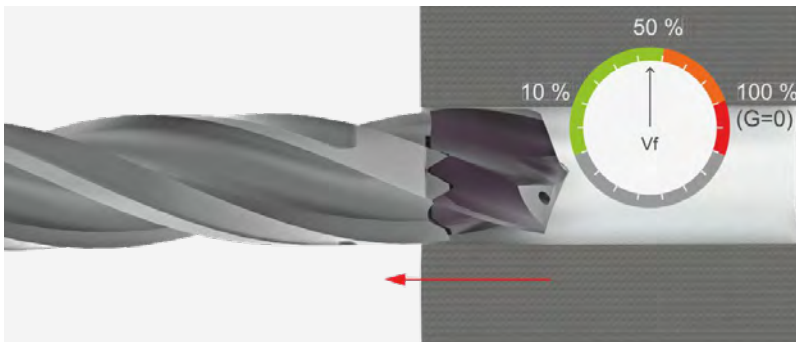

Sytuacje obróbcze:

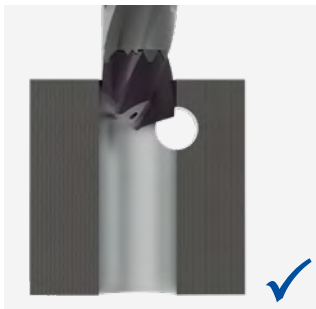

Otwór niecentryczny;
ścin w kontakcie ze ścianą otworu

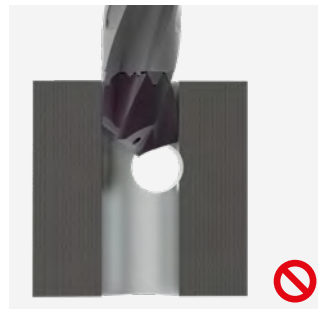

Otwór niecentryczny;
ścin poza kontaktem ze ścianą otworu

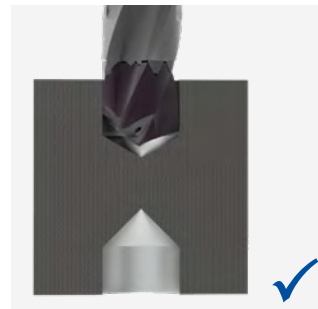

Przebiecie do otworu przeciwnego;
 $v_f = -50\%$

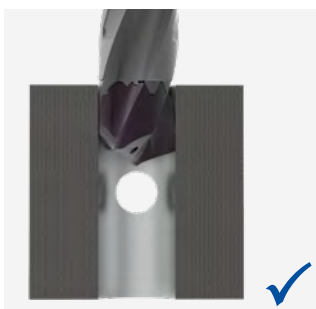

Otwór centryczny $i \ll D$



Otwór centryczny $i \approx D$



Otwór centryczny $i \gg D$

Wiercenie głębokich otworów

Dotyczy MEGA-Deep-Drill | MEGA-Deep-Drill-Alu

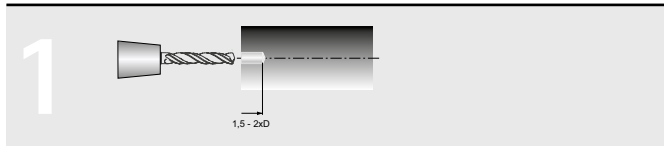

Wykonaj otwór pilotujący

- Zalecenie dotyczące wiertła pilotującego – patrz następna strona (lub o 0,01-0,02 mm większe niż średnica wiertła do głębokiego wiercenia) Głębokość otworu pilotującego pomiędzy 1,5 i 2xD

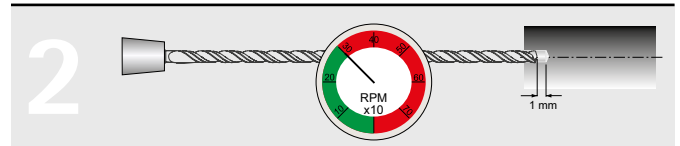

MEGA-Deep-Drill - Wprowadzenie do otworu pilotowego

- Wjazd z maks. 300 min⁻¹ i v_f = 1000 mm/min
- Bez chłodziwa - do 1 mm przed dnem otworu pilotującego
- Włączenie chłodziwa

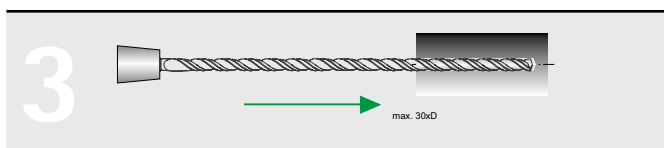

Wiercenie za pomocą MEGA-Deep-Drill

- Prędkość skrawania (v_c) i posuwu (f) wg tabeli (patrz strona 286). Wiercenie bez cyklu usuwania wiórów

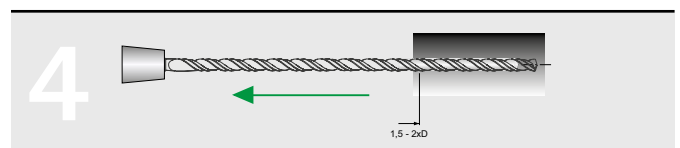

MEGA-Deep-Drill - Wycofanie

- Wycofywanie z aktualną prędkością obrotową i podwójnym posuwem (= 2 x v_f) do głębokości 1,5 - 2xD od końca otworu

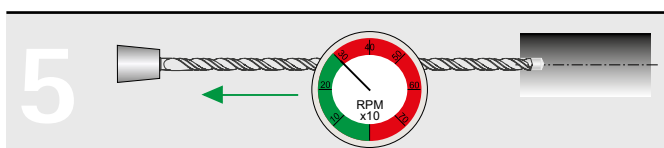

MEGA-Deep-Drill - Wyjazd z otworu

- Wyłączenie chłodziwa
- Wyjazd z maks. 300 min⁻¹ i v_f = 1000 mm/min

Informacje dotyczące zastosowania dla średnicy ≤ 3 mm:

- Dla zapewnienia odpowiedniego chłodzenia narzędzia wybierz chłodziwo zalecane do obróbki wiertłami o małej średnicy
- Zapewnij skuteczną filtrację chłodziwa, aby uniknąć zapchania kanałów doprowadzających chłodziwo
- Wybierz właściwy cykl wiercenia (ew. wiercenie z cyklem usuwania wiórów)

Wymagane ciśnienie chłodziwa

Dotyczy MEGA-Deep-Drill | MEGA-Deep-Drill-Alu

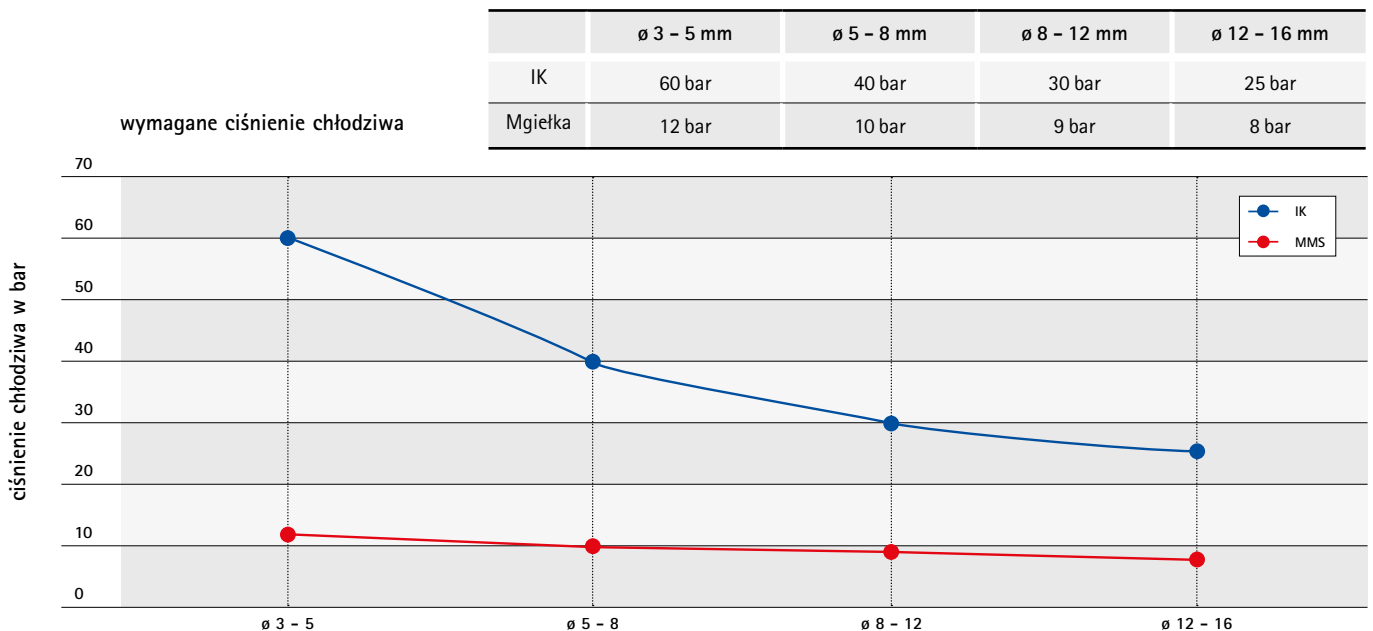

Wiercenie głębokich otworów 15xD – 30xD w dwóch etapach:

Wiercenie głębokich otworów 15xD – 30xD za pomocą MEGA-Deep-Drill (SCD171) lub MEGA-Deep-Drill-Alu (SCD181)

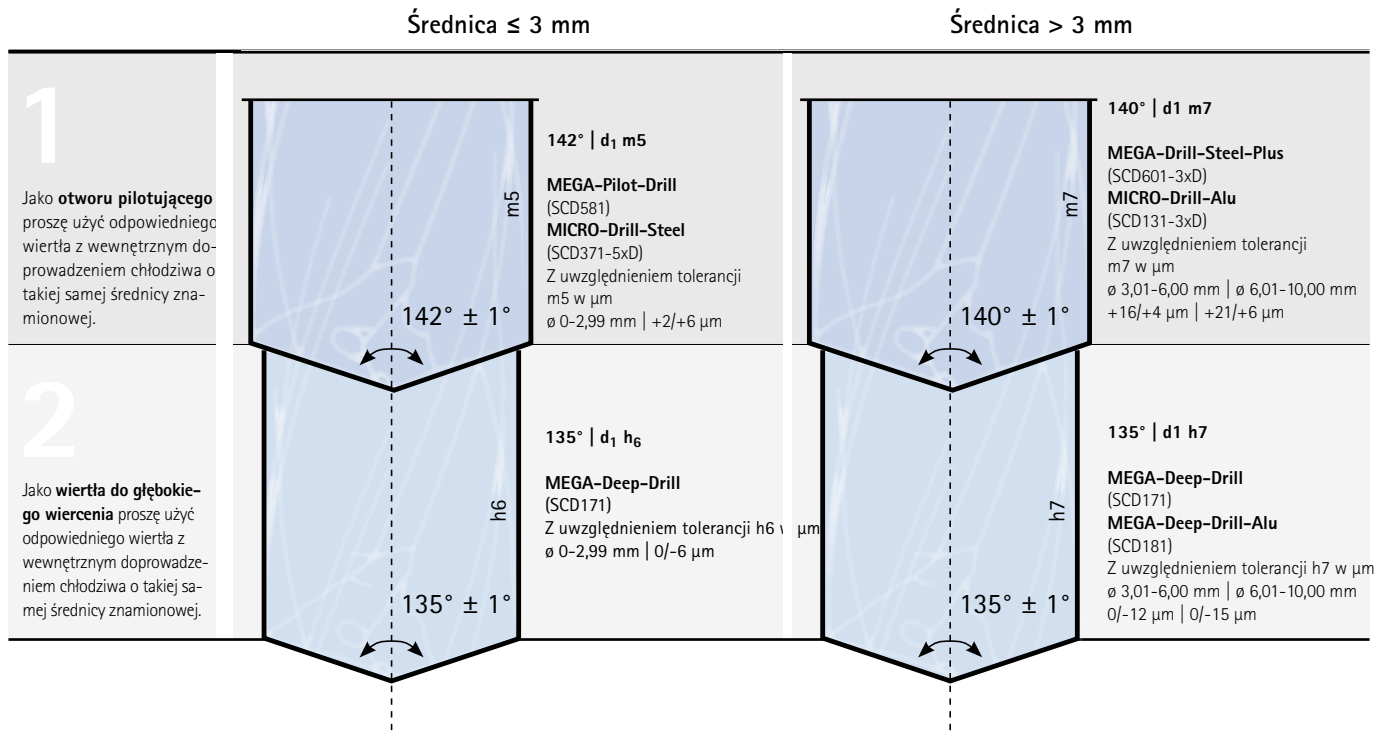

Wiercenie głębokich otworów 40xD w trzech etapach:

Wiercenie głębokich otworów 40xD za pomocą MEGA-Deep-Drill (SCD171) lub MEGA-Deep-Drill-Alu (SCD181)

Zaprojektowane optymalnie pod kątem stabilnej obróbki.

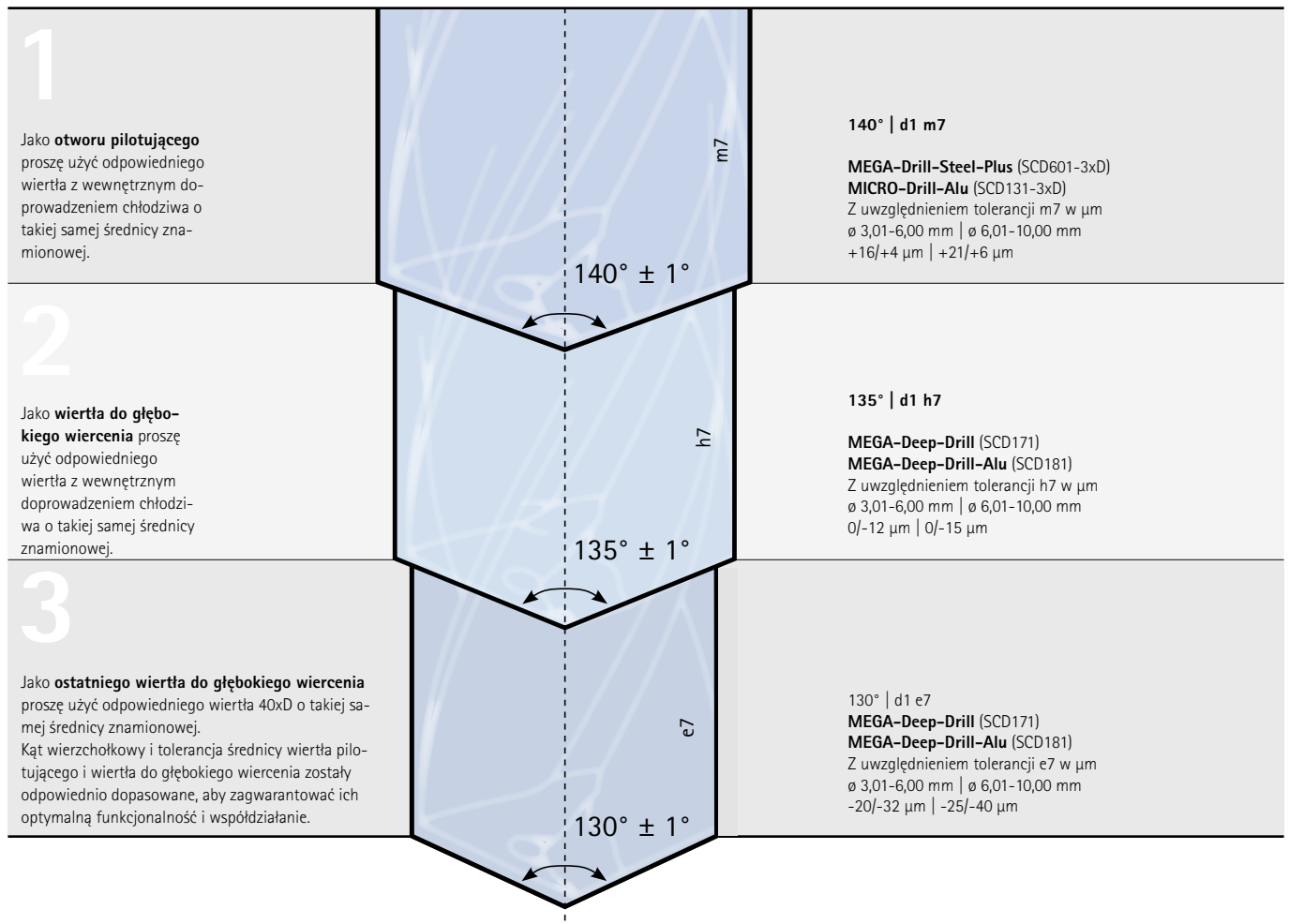

Informacje dotyczące zastosowania wiertel z płytkami skrawającymi

INFORMACJE

- Maksymalna długość narzędzia 5xD
- W przypadku stosowania wiertel o stosunku długości do średnicy większym niż trzy, zaleca się obniżenie prędkości skrawania v_c i posuwu f przy nawieraniu i przy wychodzeniu z otworu w następujący sposób:
 - 3xD: v_c -20 % | f -30 %
 - 4xD: v_c -30 % | f -40 %
 - 5xD: v_c -40 % | f -50 %



W idealnym przypadku nawiercana powierzchnia jest płaska, wpuszczona lub wstępnie wyfrezowana. Jeżeli tak nie jest, konieczne jest obniżenie posuwu o 30 do 60 procent:

- Nawieranie i wyjście z otworu na powierzchniach ukośnych i wklęsłych
- Wchodzenie wiertła w otwory poprzeczne
- Otwory w pakietach
- Nawieranie nierównych powierzchni
- Nawieranie krawędzi
- Nawieranie powierzchni kulistej
- Nawieranie zaokrąglonego konturu
- Wykonywanie rzędów częściowo zachodzących na siebie otworów
- Nawieranie otworu centrycznego
- Brak możliwości nawierania



Wiercenie otworów w pakietach



Nawieranie powierzchni kulistej



Przechodzenie przez otwór poprzeczny

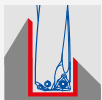

Nawieranie zaokrąglonego konturu



Nawieranie nierównej powierzchni

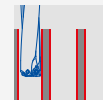

Wykonywane rzędów otworów jest możliwe w zależności od materiału

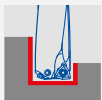

Nawieranie krawędzi



Nawieranie otworu centrycznego lub żłobka



Nawieranie powierzchni ukośnych / skośny wylot otworu



Brak możliwości nawierania

Topografia dna otworów nieprzelotowych

	Średnica D [mm]	A* [mm]	B* [mm]	C* [mm]
WOGT030206N-X40-HC698	16,00 - 20,90	3,61 (przy \varnothing 16) - 3,52 (przy \varnothing 20,9)	3,89 (przy \varnothing 16) - 6,93 (przy \varnothing 20,9)	0,40 (przy \varnothing 16) - 0,71 (przy \varnothing 20,9)
WOGT040206N-X40-HC698	21,00 - 25,90	4,06 (przy \varnothing 21) - 4,00 (przy \varnothing 25,9)	6,44 (przy \varnothing 21) - 8,95 (przy \varnothing 25,9)	0,76 (przy \varnothing 21) - 0,98 (przy \varnothing 25,9)
WOGT053006N-X40-HC698	26,00 - 30,90	5,18 (przy \varnothing 26) - 5,11 (przy \varnothing 30,9)	7,82 (przy \varnothing 26) - 10,34 (przy \varnothing 30,9)	0,81 (przy \varnothing 26) - 1,04 (przy \varnothing 30,9)
WOGT063008N-X40-HC698	31,00 - 44,90	6,41 (przy \varnothing 31) - 6,28 (przy \varnothing 44,9)	9,09 (przy \varnothing 31) - 16,18 (przy \varnothing 44,9)	1,06 (przy \varnothing 31) - 1,62 (przy \varnothing 44,9)
WOGT073808N-X40-HC698	45,00 - 54,90	7,70 (przy \varnothing 45) - 7,63 (przy \varnothing 54,9)	14,80 (przy \varnothing 45) - 19,82 (przy \varnothing 54,9)	1,57 (przy \varnothing 45) - 7,63 (przy \varnothing 54,9)

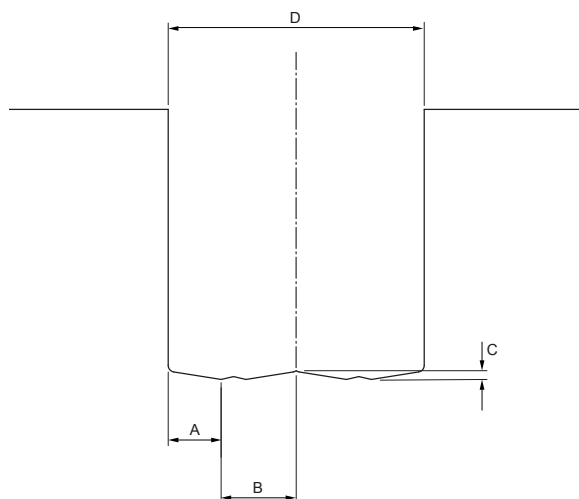
**Wskazówka dotycząca bezpieczeństwa:**

W przypadku otworów przelotowych po wyjściu wiertła z otworu wypada koronka lub tarcza bez promienia naroża. Istnieje niebezpieczeństwo wyrzucenia jej z otworu, co może spowodować szkody lub obrażenia. Aby temu zapobiec, należy podjąć odpowiednie działania zabezpieczające.

* Wartości A, B i C zmieniają się w zależności od pozycji montażowej i kąta przystawienia płytek skrawających.

Informacje dotyczące obsługi wiertła z płytkami skrawającymi QTD

Łatwa wymiana i ustawianie płytek QTD

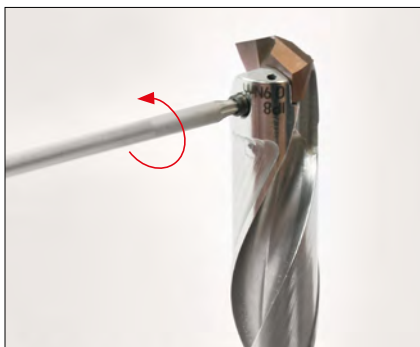

1. Poluzować śrubę mocującą specjalną za pomocą dołączonego klucza TORX® PLUS, obracając ją w kierunku przeciwnym do ruchu wskazówek zegara.



2. Wyjąć płytkę skrawającą z gniazda.



3. Gniazdo płytki oczyścić sprężonym powietrzem.

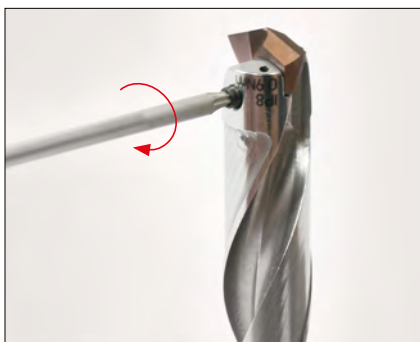

4. Umieścić w gnieździe nową płytkę skrawającą. Dokręcić śrubę mocującą specjalną za pomocą dołączonego klucza TORX® PLUS, obracając ją ręcznie w kierunku zgodnym z ruchem wskazówek zegara.



5. Dokręcić śrubę mocującą specjalną z zachowaniem podanego momentu dokręcania.

INFORMACJE

- Należy korzystać wyłącznie z oryginalnych śrub!
- Najpóźniej podczas 5. wymiany płytki QTD należy wymienić śrubę mocującą specjalną
- Zalecany moment dokręcania jest wygrawerowany na narzędziu

Wynik:

Płytkę wiercąca została wymieniona, narzędzie może być ponownie użytkowane.

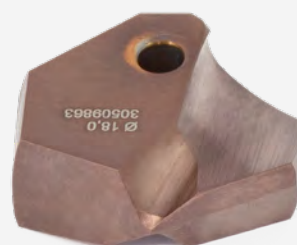

Notatki

Informacje dotyczące obsługi wiertła z wymienną głowicą TTD

Informacje praktyczne

WYKONYWANIE OTWORU PILOTUJĄCEGO

- Począwszy od głębokości wiercenia 8xD zaleca się wykonanie otworu pilotującego
- W przypadku zastosowania wymiennej głowicy typu O2 od głębokości wiercenia 5xD zaleca się wykonanie otworu pilotującego
- Przy wykonywaniu otworu pilotującego za pomocą wymiennej głowicy typu O2 zaleca się zmniejszenie podanego posuwu o 50%
- Podczas wykonywania otworów pilotujących za pomocą wymiennych głowic typu O1 i typu O3 można zastosować zalecane wartości robocze
- Wprowadzanie wiertła do otworu pilotującego następuje z tą samą geometrią głowicy i zredukowanymi wartościami roboczymi (zalecenie: $v_c = 50\%$ i $f = \text{ok. } 50\%$) do głębokości 1 mm przed dnem otworu
- Po wykonaniu otworu pilotującego wiercenie odbywa się następnie z zalecanymi wartościami roboczymi (patrz strony 224–227)

Narzędzie pionowe

W przypadku narzędzia pionowego należy ustawić wylot przestrzeni na wióry poziomo, aby uniknąć gromadzenia się wiórów.

Stan chłodziwa

Ciśnienie chłodziwa w zależności od głębokości wiercenia:

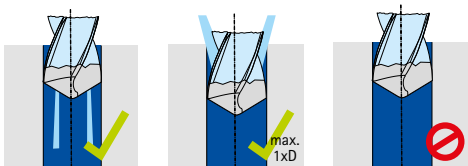

1xD: 8 bar | 3xD: 8 bar | 5xD: 12 bar | 8xD: 25 bar | 12xD: 40 bar

Maks. kąt wejścia i wyjścia

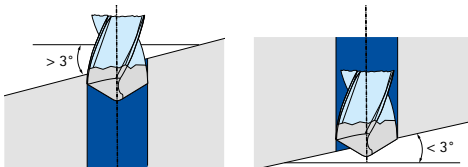

WSKAZÓWKI DOTYCZĄCE WIERCENIA PRZY UŻYCIU UCHWYTU 12xD

- Przy głębokości wiercenia 12xD konieczne jest wykonanie otworu pilotującego
- Ciśnienie chłodziwa musi wynosić co najmniej 40 barów
- Przy obróbce materiałów stalowych może być konieczne usuwanie wiórów
- Narzędzia z napędem mogą być używane na tokarce
- Zaleca się zwiększenie prędkości skrawania o 30% w stosunku do wartości standardowej

Otwór przelotowy

Przy wychodzeniu z otworu nie jest zalecane obniżanie parametrów skrawania.

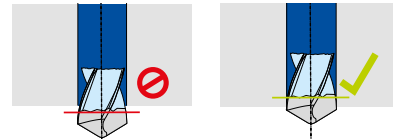

Wartość bicia

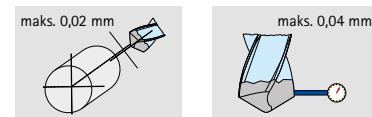

Nie śpieszyć się z wycofywaniem wiertła

Prędkość wycofywania powinna wynosić 5-krotność prędkości posuwu.

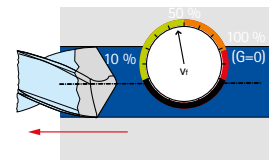

Sytuacje obróbcze

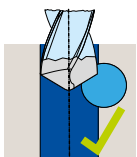

Otwór niecentryczny ścin w kontakcie ze ścianą otworu

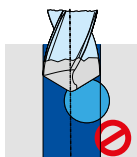

Otwór niecentryczny ścin poza kontaktem ze ścianą otworu

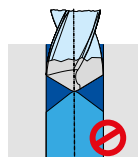

Przebiecie do otworu przeciwnastawnego

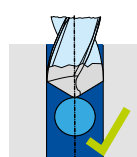

Otwór centryczny $i \ll D$

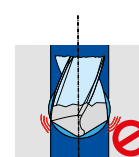

Otwór centryczny $i = D$

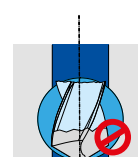

Otwór centryczny $i \gg D$

Montaż

Demontaż głowicy

1. Przy każdej wymianie głowicy należy sprawdzić śrubę mocującą pod kątem lekkiego ruchu. Jeśli śruba mocująca daje się łatwo odkręcić, należy ją wymienić. Należy korzystać wyłącznie z oryginalnych śrub mocujących!

Informacja:

Najpóźniej podczas 8. wymiany głowicy należy wymienić śrubę mocującą.



2. Odkręcić śrubę mocującą za pomocą dostarczonego klucza sześciokątnego.



3. Wyciągnąć głowicę z użębienia.

Technika mocowania głowicy



1. Oczyszczyć złącze TTS uchwytu szczotką.

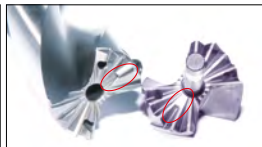

2. Nałożyć nową głowicę na uchwyt.

3. Dokręcić śrubę mocującą ręcznie w kierunku zgodnym z ruchem wskazówek zegara.

Informacja:

Zwrócić uwagę, by element pozycjonujący głowicy był zazębiony z elementem pozycjonującym uchwytu oraz by rowek mocujący i użębienie głowicy i uchwytu pasowały do siebie.

Momenty dokręcania śruby mocującej

Zakres średnic [mm]	Uchwyt na głowicę wymienną na gwint	Szerokość w poprzek mieszkania	Dopuszczalna przenoszona Moment dokręcenia [Nm]
12,00 - 13,49	M2,5	1,3	1,0
13,50 - 16,49	M3	1,5	1,3
16,50 - 24,49	M4x0,5	2	3,5
24,50 - 32,49	M5x0,5	2,5	4,0
32,50 - 41,49	M6x0,5	3	6,0
41,50 - 45,49	M8x1	4	10,0

Informacje dotyczące obsługi wiertel z wymienną głowicą TTD-Tritan

Montaż narzędzia

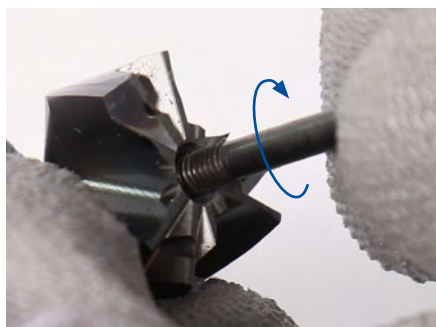

- 1. Włożyć i dokręcić śrubę mocującą specjalną**
Włożyć śrubę mocującą specjalną stroną z małym gwintem do otworu w wymiennej głowicy. Następnie dokręcić śrubę mocującą specjalną do oporu w kierunku zgodnym z ruchem wskazówek zegara.



- 2. Oczyszczyć sprężonym powietrzem**
Oczyszczyć uchwyt wymiennej głowicy i wymienną głowicę sprężonym powietrzem.

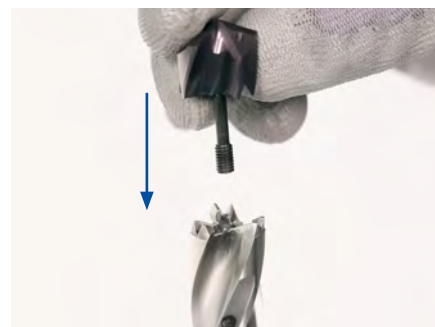

- 3. Nałożyć wymienną głowicę**
Nałożyć wymienną głowicę na uchwyt.

Informacja:

W momencie dostawy śruba mocująca specjalna jest już zamontowana na wymiennej głowicy. Po odkręceniu śruby mocująca specjalna może być ponownie zamontowana w wymiennej głowicy przez wkręcenie.

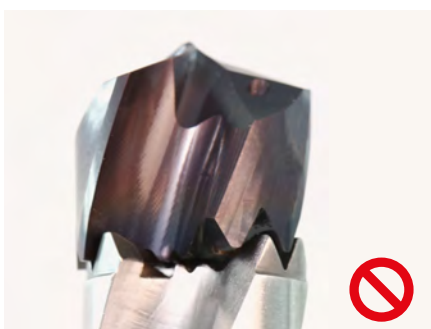
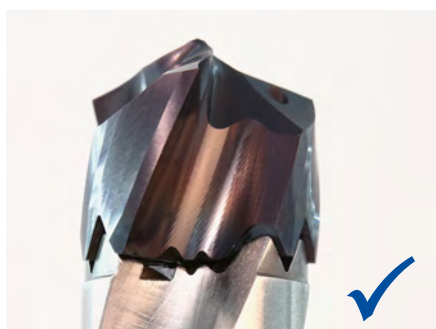

- 4. Sprawdzić ustawienie głowicy**
Sprawdzić, czy rowek wiórowy i uzębienie wymiennej głowicy i uchwytu pasują do siebie. Jeżeli tak nie jest, należy obrócić głowicę do momentu, aż rowek wiórowy i uzębienie będą pasować do siebie.

Wynik:

Rowek wiórowy i uzębienie pasują do siebie (po lewej) | nie pasują do siebie (po prawej)



- 1 Rękojeść klucza TORX®
- 2 Uchwyt wymiennej głowicy TTS
- 3 Klucz TORX®
- 4 Wymienna głowica ze śrubą mocującą specjalną

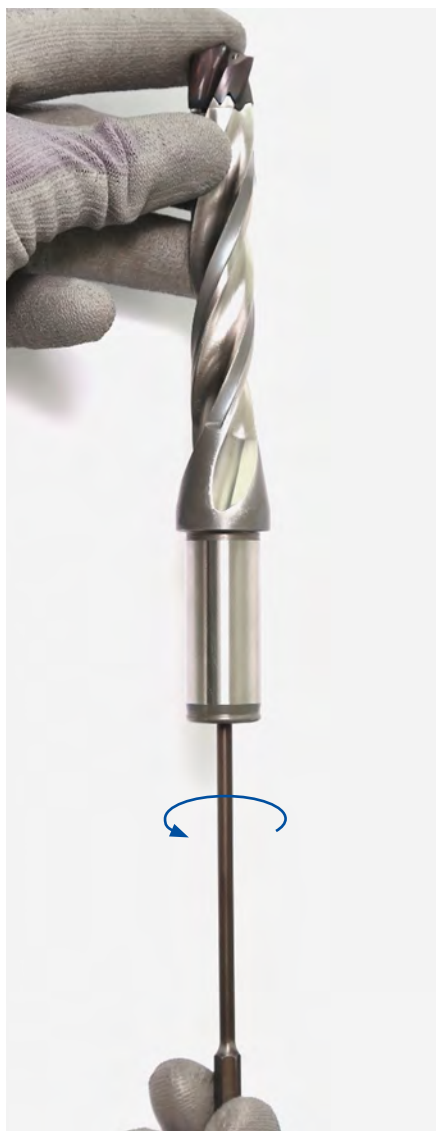

5. Dokręcić śrubę mocującą specjalną do oporu

Przytrzymać lekko wymienną głowicę przy uchwycie, aby utrzymać ją w położeniu, w jakim została nałożona na uchwyt. Następnie wsunąć klucz TORX® w centralny otwór uchwytu wymiennej głowicy aż do otworu gwintowanego w śrubie mocującej specjalnej. Następnie dokręcić ręcznie śrubę mocującą specjalną do oporu za pomocą klucza TORX® w kierunku przeciwnym do ruchu wskazówek zegara.



6. Dokręcić śrubę mocującą specjalną momentem dokręcania

Za pomocą odpowiedniego klucza dynamometrycznego z bitem sześciokątnym w połączeniu z kluczem TORX® dokręcić śrubę mocującą specjalną podanym momentem dokręcania.

Informacja:

Wymagany moment dokręcania specjalnej śruby mocującej jest podany na spodniej stronie uchwytu wymiennej głowicy.

Wynik:

Śruba mocująca specjalna jest dokręcona wymaganym momentem dokręcania, a wymienna głowica jest stabilnie połączona z uchwycem. Proces montażu został zakończony.

Zakres dostawy:

- 1 Rękojeść klucza TORX®
- 2 Uchwyt wymiennej głowicy TTS
- 3 Klucz TORX®

Momenty dokręcania śruby mocującej specjalnej

Zakres średnicy [mm]	Gwint Wymienny uchwyt głowicy	Rozmiar TORX®	Dopuszczalny przenoszony moment dokręcania [Nm]
12,00 - 13,99	M3 x 0,5	T6	0,40
14,00 - 17,49	M3,5 x 0,6	T7	0,70
17,50 - 19,49	M4 x 0,7	T8	1,30
19,50 - 24,49	M5 x 0,8	T10	2,00
24,50 - 28,49	M6 x 1,0	T15	3,10
28,50 - 32,49	M6 x 1,0	T15	5,60

Geometrie nakroju i kąty natarcia

Rozwiertak wielostrzowy

Typszereg FXR, MOR, MPR, HPR

Nakrój

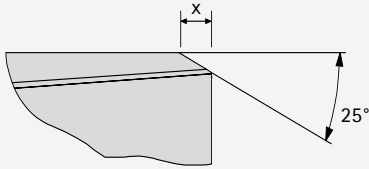
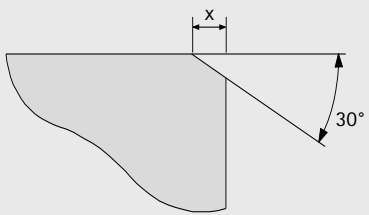
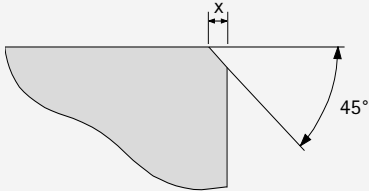
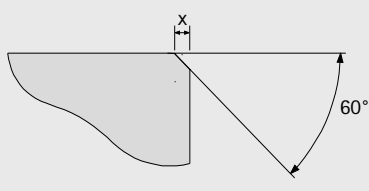
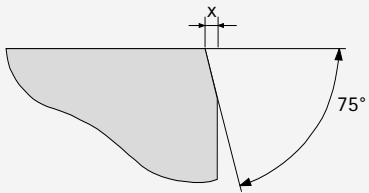
Geometria	Geometria nakroju	
	Opis	Geometria
	ML	25°
	ME	30°
	MF	
	MG	
	MY	
	MC	45°
	MO	
	MU	
	MV	60°
	MT	
	MA	75°

x = długość nakroju

Kształt wióra/kąt natarcia

Kąt natarcia	
Opis	Kąt
0A	0°
1 F	5°
1G	6°
1M	13°
2A	0° (dla otworu nieprzelotowego)
2G	6° (dla otworu nieprzelotowego)
3C	-2°

Wyjaśnienie dotyczące materiałów skrawających	
Opis	Wyjaśnienie
HU	Węglik spiekany bez powłoki
HP	Węglik spiekany z powłoką PVD
HC	Węglik spiekany z powłoką CVD
CU	Cermet bez powłoki
CP	Cermet z powłoką PVD
PU	PCD

Przegląd typoszeregu | Zakres średnicy | Symbol nakroju | Długość nakroju

Typoszereg	Symbol nakroju	Zakres średnicy	Długość nakroju x
FXR	MC	2,81 - 3,35	0,30
		3,36 - 4,05	0,40
		4,06 - 5,60	0,50
		5,61 - 6,60	0,60
		6,61 - 7,60	0,70
		7,61 - 11,60	0,80
		11,61 - 20,10	1,00
	MF	2,81 - 3,70	0,70
		3,71 - 6,20	0,90
		6,21 - 12,20	1,20
		12,21 - 20,20	1,50
	MG	2,81 - 3,70	0,70
		3,71 - 6,20	0,90
		6,21 - 12,20	1,20
		12,21 - 20,20	1,50
	MT	2,81 - 6,20	0,30
		6,21 - 10,70	0,40
		10,71 - 16,20	0,50
		16,21 - 20,20	0,60
	MV	2,81 - 6,20	0,30
		6,21 - 10,70	0,40
		10,71 - 16,20	0,50
		16,21 - 20,20	0,60

Typoszereg	Symbol nakroju	Zakres średnicy	Długość nakroju x
MOR	MY	7,70 - 40,20	1,00
	MU	7,70 - 40,20	0,60
MRP	MG	3,85 - 6,20	0,90
		6,21 - 10,70	1,20
		10,71 - 20,20	1,50
		20,21 - 40,20	1,50
	MV	3,85 - 6,20	0,30
		6,21 - 10,70	0,40
		10,71 - 20,20	0,50
		20,21 - 26,20	0,60
	26,21 - 40,20	0,80	
HPR	MA	7,00 - 65,00	0,40
	MC	7,00 - 65,00	0,55
	ME	7,00 - 65,00	1,40
	MF	7,00 - 65,00	1,40
	ML	7,00 - 65,00	1,00
	MO	7,00 - 65,00	0,60

Informacje dotyczące obsługi systemu HFS®

System MAPAL HFS® z mocowaniem osiowym

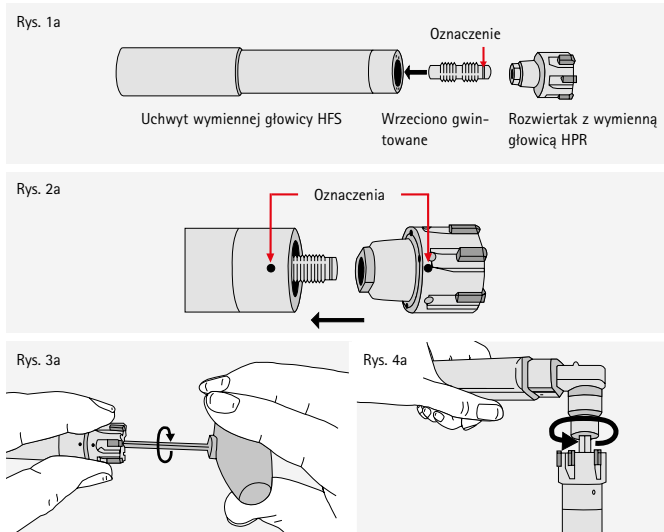

System MAPAL HFS® z mocowaniem promieniowym

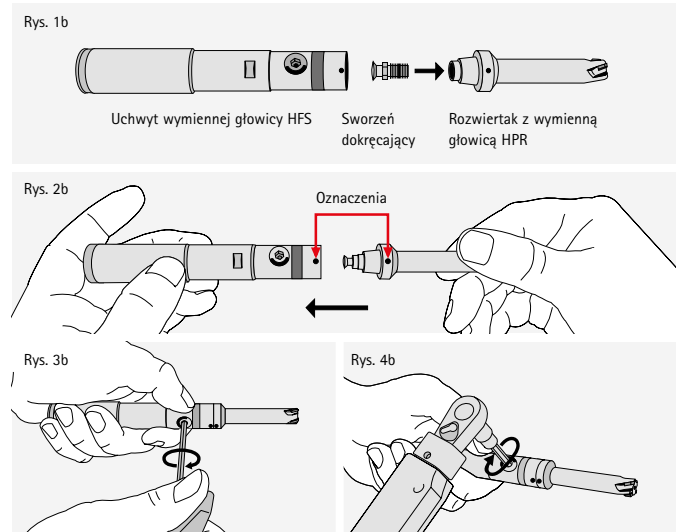

Czyszczenie

Oczyszczyć wszystkie elementy i upewnić się, czy na stożku wewnętrznym i zewnętrznym oraz na powierzchni czołowej stożka HFS nie ma ciał obcych (np. wiórów). Do czyszczenia stożka wewnętrznego zaleca się użycie specjalnego wyciora stożkowego (patrz strona 474).

Technika mocowania

- Włożyć koniec wrzeciona gwintowanego bez oznaczenia do uchwytu wymiennej głowicy HFS; nie dokręcać wrzeciona (patrz rys. 1a).
- Założyć rozwiertak z wymienną głowicą HPR na wrzeciono gwintowane. Należy przy tym ustawić w jednej linii oznaczenia na rozwiertaku z wymienną głowicą HPR i na uchwycie wymiennej głowicy HFS: „punkt do punktu” (patrz rys. 2a). Następnie włożyć rozwiertak z wymienną głowicą HPR całkowicie do uchwytu wymiennej głowicy HFS i przytrzymać obie części.
- Skręcić rozwiertak z wymienną głowicą HPR i uchwyt wymiennej głowicy HFS za pomocą klucza imbusowego i mocno dokręcić. Zwrócić uwagę, by oznaczenia były ustawione w jednej linii i powierzchnie czołowe elementów przylegały do siebie (patrz rys. 3a).
Informacja: HPR 100, 110, 150 są dokręcane przez rozwiertak (kierunek obrotów zgodny z ruchem wskazówek zegara). HPR 130, 131, 180 są dokręcane przez uchwyt (kierunek obrotów przeciwny do ruchu wskazówek zegara). Kierunki obrotów są zaznaczone na uchwycie.
- Informacja:** Uchwyt wymiennej głowicy HFS są oznakowane wymaganym momentem dokręcania. Rozwiertak z wymienną głowicą HPR dokręcić kluczem dynamometrycznym w kierunku zgodnym z ruchem wskazówek zegara (patrz rys. 4a).

Odkręcanie

- Informacja:** Kierunek obrotów podczas odkręcania rozwiertaka z wymienną głowicą HPR jest przeciwny do kierunku obrotów podczas mocowania. W celu odkręcenia rozwiertaka z wymienną głowicą HPR należy obrócić wrzeciono gwintowane za pomocą klucza imbusowego.
- Zdjąć rozwiertak z wymienną głowicą HPR.

Ustawianie rozwiertaka z wymienną głowicą HPR z precyzyjną regulacją

- Informacja:** Przeciwległa para ostrzy leżąca na przedłużeniu okrągłych punktów (oznaczeń) na uchwycie wymiennej głowicy HFS i rozwiertaku z wymienną głowicą HPR służy jako punkt odniesienia do pomiaru i regulacji średnicy narzędzia. Zamocować rozwiertak z wymienną głowicą HPR w uchwycie wymiennej głowicy HFS.
- Ustawić żądaną średnicę narzędzia za pomocą mikrometru noniuszowego. Następnie przyłożyć mikrometr noniuszowy do ostrzy referencyjnych.
- Przyłożyć klucz TORX® do śruby regulacyjnej i powoli obracać ją w kierunku zgodnym z ruchem wskazówek zegara. Ustawić rozwiertak z wymienną głowicą HPR na żądany wymiar.



Technika mocowania

- Wkręcić sworzeń dociągający stroną gwintowaną w rozwiertak z wymienną głowicą HPR z gwintem lewym (patrz rys. 1b).
- Włożyć rozwiertak z wymienną głowicą HPR całkowicie do uchwytu wymiennej głowicy HFS. Należy przy tym ustawić w jednej linii oznaczenia na rozwiertaku z wymienną głowicą HPR i na uchwycie wymiennej głowicy HFS: „punkt do punktu” (patrz rys. 2b). Następnie przytrzymać obie części.
- Obrócić sworzeń mocujący zgodnie z ruchem wskazówek zegara za pomocą klucza imbusowego (patrz rys. 3b). Kierunek obrotów jest zaznaczony na uchwycie wymiennej głowicy HFS.
- Informacja:** Uchwyt wymiennej głowicy HFS są oznakowane wymaganym momentem dokręcania. Rozwiertak z wymienną głowicą HPR dokręcić kluczem dynamometrycznym w kierunku zgodnym z ruchem wskazówek zegara (patrz rys. 4b).

Wielkość złącza HFS	Moment dokręcenia [Nm]	
	osiowy	promieniowy
10	4	-
12	6	7
14	6	7
16	15	12
20	15	12
24	20	-

Odkręcanie

- W celu odkręcenia rozwiertaka należy obrócić sworzeń mocujący w kierunku przeciwnym do ruchu wskazówek zegara do oporu za pomocą klucza imbusowego.
→ Rozwiertak z wymienną głowicą HPR zostaje wypchnięty i można go wyjąć.

Uwaga dotycząca wariantów HPR z systemem regulacji:

W przypadku rozwiertaków z wymienną głowicą HPR z precyzyjną regulacją do \varnothing 30 mm i HFS wielkości 12 do 20, technika mocowania rozwiertaka z wymienną głowicą HPR jest możliwa tylko promieniowo. Począwszy od \varnothing 30 mm i wielkości HFS 24 rozwiertak z wymienną głowicą HPR może być mocowany również przy użyciu wrzeciona gwintowanego.

Doprowadzanie chłodziwa w systemie HFS®

Aby możliwe było pełne wykorzystanie wysokiej wydajności rozwiertek HPR, różne typy szeregi wymiennych głowic wymagają każdorazowo odpowiedniego układu doprowadzania chłodziwa. Różnica między komponentami układu polega na zastosowaniu wrzeciona gwintowanego lub sworznicy dociągającej. W zależności od wariantu głowicy są one stosowane z przepływem chłodziwa lub bez, dzięki czemu zapewnione jest bezpośrednie doprowadzanie chłodziwa przez złącze do ostrzy.

Informacja:

Wszystkie uchwyty z HFS wielkości 12 są zawsze w zakresie dostawy z obiema wersjami. Przy montażu należy więc zwrócić uwagę na dobór systemu pasującego do wymiennej głowicy (patrz rys. poniżej)

Doprowadzanie chłodziwa bez przepływu centralnego

Rozwiertaki muszą być montowane bez centralnego przepływu chłodziwa. Chłodziwo przepływa z uchwyty do wymiennej głowicy przez powierzchnię czołową.

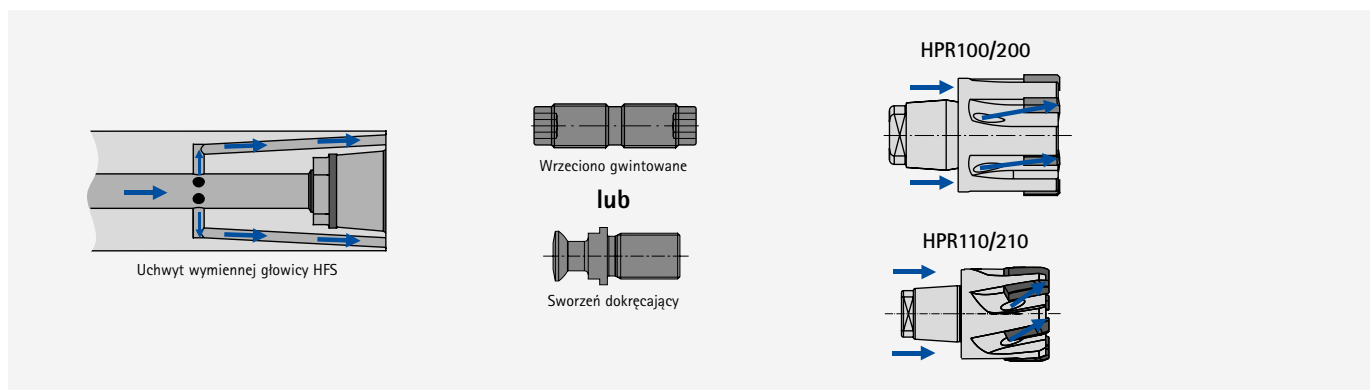

Doprowadzanie chłodziwa z przepływem centralnym

Wszystkie wymienione rozwiertaki muszą być montowane z centralnym przepływem chłodziwa. Przepływ chłodziwa następuje centralnie, a w przypadku HPR150 i HPR250 dodatkowo przez powierzchnię czołową.

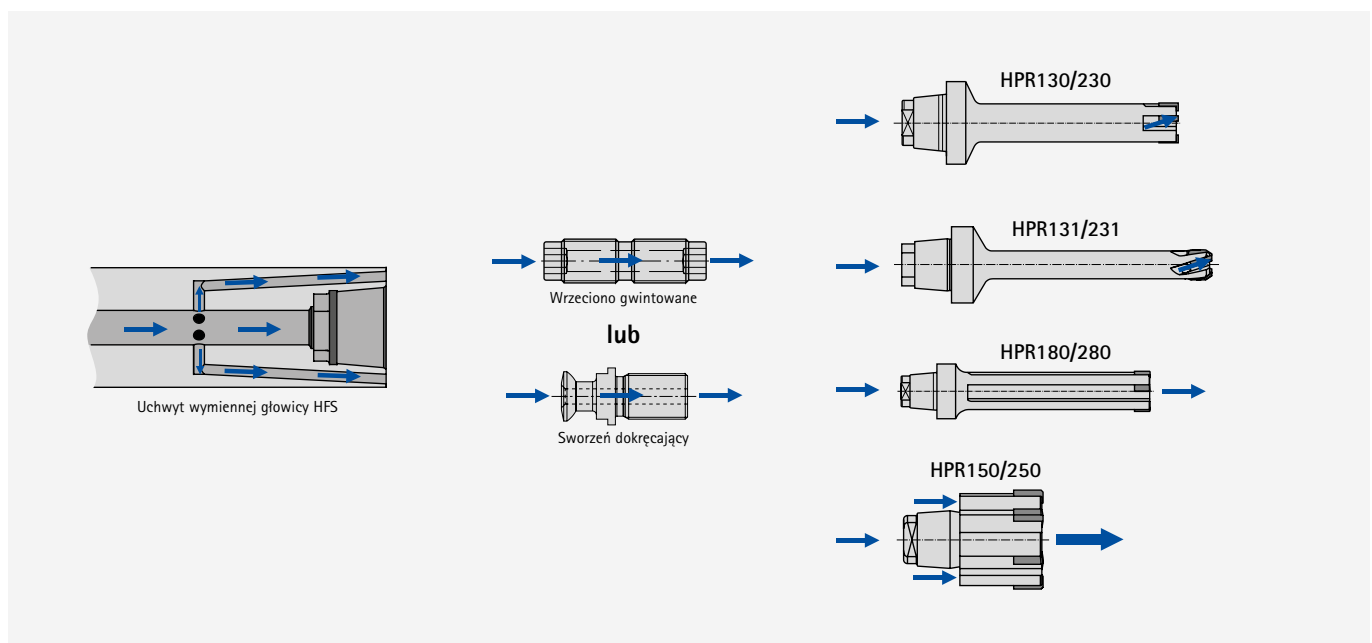

Informacje dotyczące obsługi systemu HPR400

HPR400 stanowi system, w którym możliwa jest szybka i ekonomiczna wymiana narzędzia bezpośrednio u klienta. Wymienne płytki skrawające są wsuwane osiowo do przygotowanego gniazda płytki skrawającej i stabilnie mocowane w korpusie śrubą TORX®. Zawsze zachowana jest przy tym typowa jakość obróbki z dokładnością do μm .

Wymiana płytek skrawających

Informacja:

Przy wymianie płytek skrawających konieczna jest wymiana wszystkich płytek!



1. Oczyszczyć HPR400 za pomocą sprężonego powietrza i szmatki.
Wykręcić śrubę TORX®, obracając ją w kierunku przeciwnym do ruchu wskazówek zegara za pomocą odpowiedniego wkrętaka TORX®.
Po odkręceniu wyjąć śrubę TORX®.



2. Ostrożnie wypchnąć płytkę z gniazda płytki skrawającej w kierunku osiowym i wyjąć ją. Wyjąć pozostałe płytki skrawające, powtarzając kroki 1 i 2.

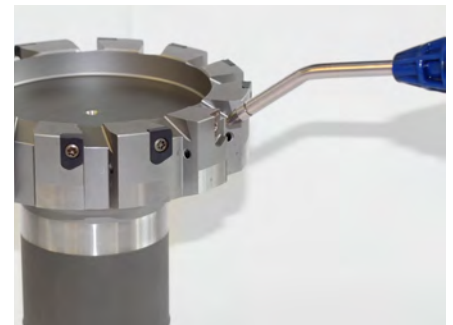

Uwaga:

Tylko dla przeszkolonego personelu.

3. Informacja: W przypadku zabrudzenia oczyścić powierzchnie styku płytek skrawających.

Oczyścić gniazda płytek skrawających sprężonym powietrzem. Następnie prawidłowo oczyścić gniazda płytek odpowiednim alkoholem.



4. Włożyć nową płytkę skrawającą do połowy do gniazda. Następnie kciukiem lekko wepchnąć płytkę skrawającą do gniazda i jednocześnie przesunąć ją osiowo w dół do położenia końcowego.
Aby zapobiec wypadnięciu płytki skrawającej, zamocować ją za pomocą śruby TORX®.

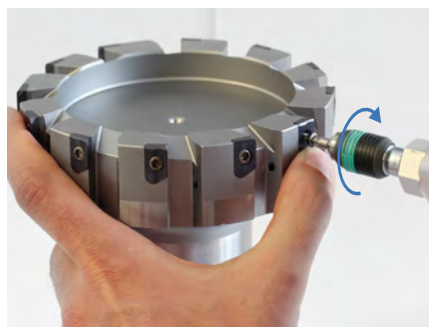

5. Informacja: Śruby TORX® dokręcać tylko odpowiednim kluczem dynamometrycznym.

Dokręcić śrubę TORX® momentem dokręcania 3,1 Nm.

Wynik:

Wszystkie płytki skrawające są wymienione i system HPR400 jest gotowy do użycia.

Informacje dotyczące obsługi systemu HPR400 plus

Czteroostrzowe płytki skrawające systemu HPR400 plus są wykonane tak precyzyjnie, że również w ich przypadku bez problemu możliwe jest ich obracanie lub wymiana na miejscu przez personel klienta.



Wymiana płytek skrawających

Warunek:

Przed rozpoczęciem wymiany płytek skrawających należy oczyścić narzędzie.

Uwaga:

Tylko dla przeszkolonego personelu.



1. Odkręcić śrubę TORX® PLUS przy użyciu odpowiedniego wkrętaka, obracając ją w kierunku przeciwnym do ruchu wskazówek zegara. Następnie wyjąć śrubę TORX® PLUS.



2. Ostrożnie wypchnąć płytkę skrawającą z gniazda w kierunku osiowym ku górze i wyjąć ją. Wyjąć pozostałe płytki skrawające.



3. Oczyścić gniazda płytek sprężonym powietrzem i prawidłowo oczyścić gniazda płytek odpowiednim alkoholem. Oczyścić powierzchnie styku płytek skrawających środkiem czyszczącym.



Informacja:

Podczas obracania płytki skrawającej należy przestrzegać kolejności krawędzi skrawających, oznaczonej punktami (od jednego do czterech).

Informacja:

Przy wymianie płytek skrawających konieczne jest obrócenie lub wymiana wszystkich płytek!



4. Włożyć nową lub obróconą płytkę skrawającą do połowy do gniazda. Następnie kciukiem lekko wepchnąć płytkę skrawającą do gniazda i jednocześnie wsunąć ją osiowo w dół do gniazda. Następnie zamocować płytkę skrawającą za pomocą śruby TORX® PLUS.



5. Dokręcić śrubę TORX® PLUS podanym moment dokręcania w kierunku zgodnym z ruchem wskazówek zegara.

Informacja:

Śruby TORX® PLUS dokręcać tylko odpowiednim kluczem dynamometrycznym. Moment dokręcania śrub TORX® PLUS wynosi 3,5 Nm.

Wynik:

Wszystkie płytki skrawające są wymienione i narzędzie jest gotowe do użycia.

Informacje dotyczące regulacji rozwiertaków jednoostrzowych WP

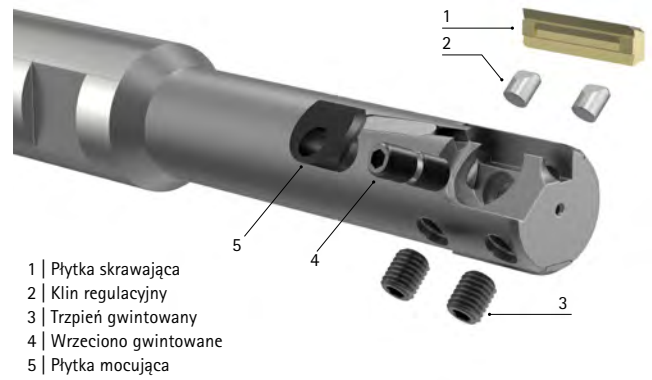

- 1 | Płytkę skrawającą
- 2 | Klin regulacyjny
- 3 | Trzpień gwintowany
- 4 | Wrzeciono gwintowane
- 5 | Płytkę mocującą

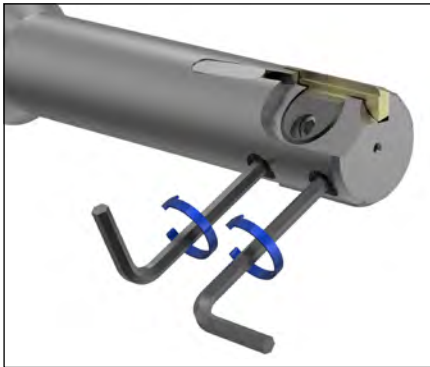

1. Obrócić oba trzpienie gwintowane o 1/2 obrotu w kierunku przeciwnym do ruchu wskazówek zegara.



2. Odkręcić płytkę mocującą: obrócić wrzeciono gwintowane o 2-3 obroty z obu stron w kierunku przeciwnym do ruchu wskazówek zegara (płytkę skrawającą skierowaną w dół).

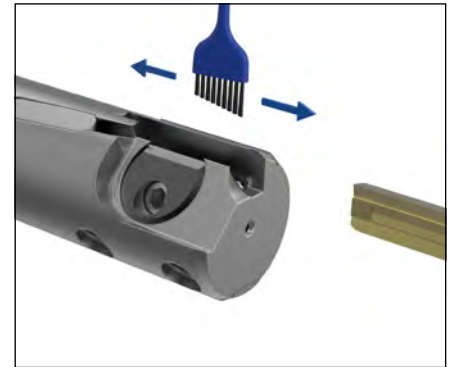

3. Wyjąć płytkę skrawającą.
4. Oczyszczyć płytkę skrawającą i gniazdo płytki skrawającej.

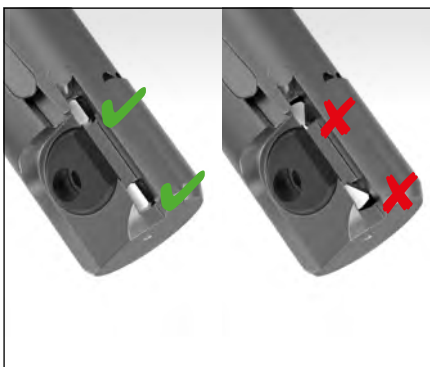

5. Zwrócić uwagę na proste ustawienie klinów regulacyjnych.
6. Włożyć nową lub obróconą płytkę skrawającą do gniazda.

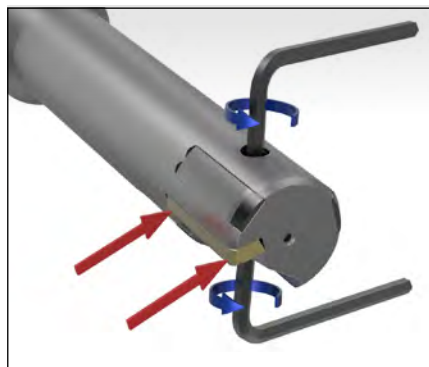

7. Przycisnąć i przytrzymać płytkę skrawającą i dokręcić wrzeciono gwintowane wymaganym momentem dokręcania z obu stron w kierunku zgodnym z ruchem wskazówek zegara.

8. Obrócić oba trzpienie gwintowane o 1/4 obrotu w kierunku zgodnym z ruchem wskazówek zegara.

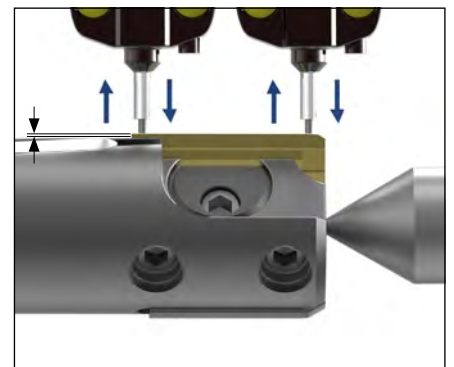

9. Ustawić przedni i tylny wymiar regulacyjny na przemian za pomocą trzpieni gwintowanych. Pochylenie ku tyłowi ok. 1 μm/mm.

INFORMACJA:

Zestawienie momentów dokręcania w formacie PDF znajduje się na stronie internetowej MAPAL:

www.mapal.com → Mediateka → Instrukcje i informacje dotyczące obsługi → Ogólne informacje techniczne → Momenty dokręcenia dla śrub mocujących MAPAL

Informacje dotyczące regulacji rozwiertaków jednoostrzowych HX

Wielkość 2 i wielkość 3

- | | |
|--------------------------|------------------------|
| 1 Płytkę mocującą | 5 Klin regulacyjny |
| 2 Wrzeciono gwintowane | 6 Trzpień gwintowany |
| 3 Płytkę skrawającą HX | |
| 4 Kasetę | |

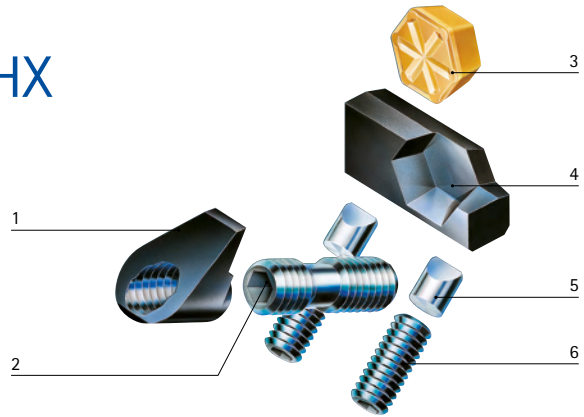

Wymiana i regulacja płytek skrawających

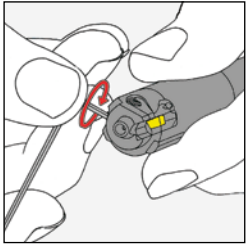

1. Obrócić przedni i tylny trzpień gwintowany o pół obrotu w lewo.

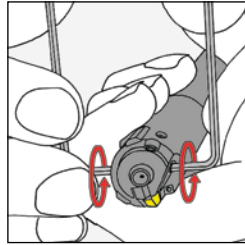

2. **Informacja:** Do odkręcania należy użyć dwóch kluczy. W celu odkręcenia płytki mocującej i kasety należy obrócić wrzeciono gwintowane w kierunku zgodnym z przeciwnym do ruchu wskazówek zegara.

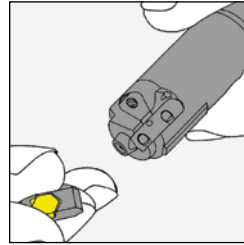

3. Wyjąć płytkę skrawającą i kasetę. Oczyszczyć płytkę skrawającą, kasetę i gniazdo płytki skrawającej (nie używać sprężonego powietrza, uwzględnić klina regulacyjnego). Obrócić płytkę skrawającą o 60° lub włożyć nową płytkę do kasety. Ponownie zamontować kasetę.

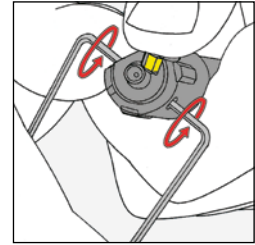

4. **Informacja:** Do dokręcania należy użyć dwóch kluczy. Dosunąć płytkę skrawającą i kasetę do tylnego ogranicznika i klina regulacyjnego. Obrócić wrzeciono gwintowane od góry w prawo i od dołu w lewo i dokręcić.

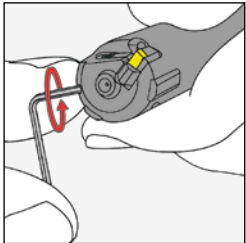

5. W celu regulacji zgrubnej należy obrócić przedni i tylny trzpień gwintowany o ćwierć obrotu w prawo.

Dla uproszczenia obsługi i zagwarantowania stabilności ustawienia zalecamy użycie przyrządu do ustawiania narzędzi MAPAL.

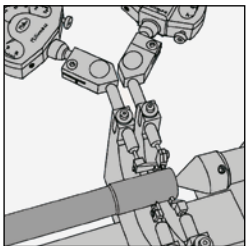

7. Skalibrować MAPAL MASTERSET trzpieniem regulacyjnym (należy zamówić oddzielnie). Trzpień regulacyjny ma najmniejszy wymiar otworu.

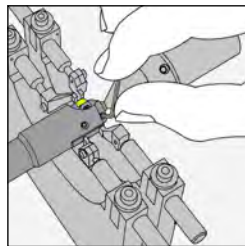

8. Ustawić przedni i tylny wymiar regulacyjny na przemian za pomocą trzpieni gwintowanych. Pochylenie ku tyłowi wynosi ok. 0,005 do 0,010 mm.

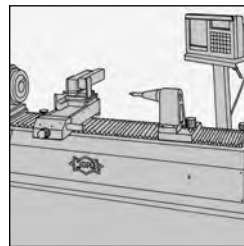

9. MAPAL UNISSET: Do wygodnej regulacji rozwiertaków MAPAL oferuje elektroniczny przyrząd do ustawiania narzędzi w wersji pionowej i poziomej. Więcej informacji znajduje się w katalogu „USTAWIENIA | POMIARY | WYDAWANIE NARZĘDZI”.

Szczegółowe instrukcje dotyczące regulacji znajdują się w instrukcji obsługi urządzenia.

Informacje dotyczące obsługi systemu EasyAdjust

Wymiana i regulacja płytki skrawającej

System EasyAdjust umożliwia prostą i szybką wymianę płytek skrawających. Do wymiany płytki skrawającej i wyregulowania jej z dokładnością do μm wystarczy kilka kroków.



1. Odkręcić klin regulacyjny za pomocą klucza imbusowego i obrócić go o pół obrotu w kierunku przeciwnym do ruchu wskazówek zegara.

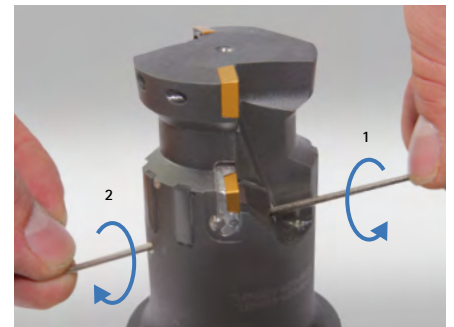

2. Informacja: Do odkręcenia potrzebne są dwa klucze imbusowe.

Aby poluzować pazur zaciskowy, należy obrócić klucz imbusowy 1 w kierunku przeciwnym do ruchu wskazówek zegara, a klucz imbusowy 2 w kierunku zgodnym z ruchem wskazówek zegara.



3. Docisnąć kasetę wraz z klinem regulacyjnym do przodu w kierunku narzędzia.



4. Wyjąć płytkę skrawającą z kasety.



5. Wymienić lub obrócić płytkę skrawającą. Następnie włożyć płytkę do kasety.

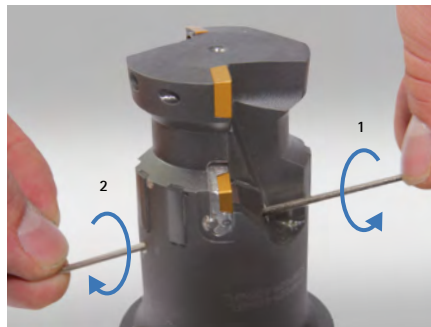

6. **Informacja:** Do dokręcenia potrzebne są dwa klucze imbusowe.

Aby dociągnąć pazur zaciskowy, należy obrócić klucz imbusowy 1 w kierunku zgodnym z ruchem wskazówek zegara, a klucz imbusowy 2 w kierunku przeciwnym do ruchu wskazówek zegara.

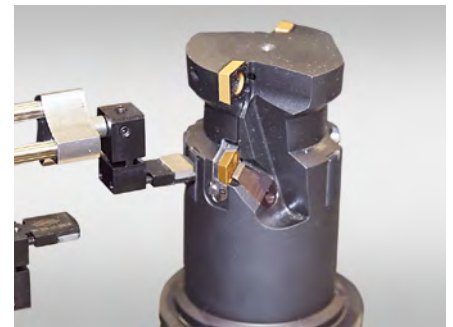

7. **Informacja:** Kontynuować pomiar występu albo pomiar bezwzględny.

Zamocować narzędzie w chwycie przyrządu do ustawiania narzędzi. Przesunąć czujnik do najwyższego punktu listwy prowadzącej i wyzerować w tym miejscu wartość pomiarową.

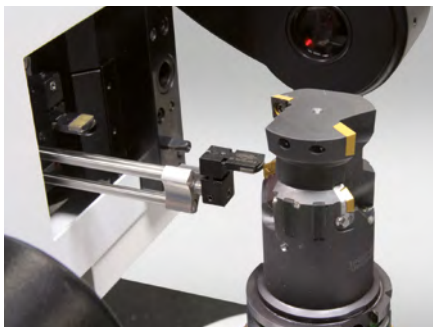

8. Przesunąć czujnik do najwyższego punktu płytki skrawającej.



9. Wyregulować występ lub wymiar bezwzględny płytki skrawającej, obracając trzpień gwintowany za pomocą klucza imbusowego w kierunku zgodnym z ruchem wskazówek zegara.

Wynik:

Żądany występ lub wymiar bezwzględny płytki skrawającej jest ustawiony.

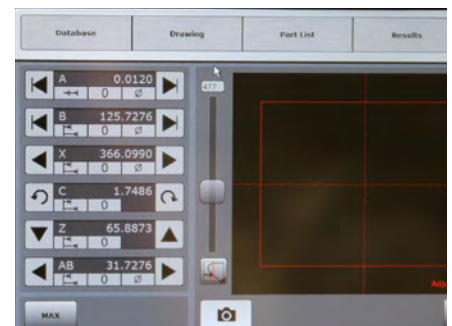

Instrukcja montażu i regulacji rozwiertaka zewnętrznego z systemem EA



Wymiana płytki skrawającej



1. Obrócić obie śruby mocujące TORX® w kierunku przeciwnym do ruchu wskazówek zegara i wyjąć kasetę.



2. Ustawić płytkę skrawającą z powrotem w położeniu podstawowym: Obrócić śrubę regulacyjną z powrotem o pół obrotu w kierunku przeciwnym do ruchu wskazówek zegara.



3. Obrócić wrzeciono gwintowane o 1,5 obrotu w kierunku przeciwnym do ruchu wskazówek zegara.



4. Wyjąć płytkę skrawającą TEC. Oczyszczyć gniazdo płytki i płytkę skrawającą TEC.

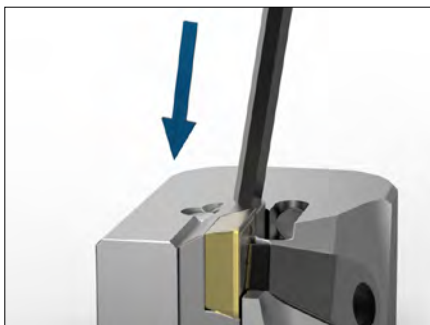

5. Włożyć nową lub obróconą płytkę skrawającą do gniazda, zwracając uwagę docisk osiowy i promieniowy. Lekko popchnąć kasetę z płytką skrawającą do tyłu w kierunku przeciwnym do kierunku regulacji.



6. Ręcznie dokręcić wrzeciono gwintowane pazura zaciskowego w kierunku zgodnym z ruchem wskazówek zegara.

Regulacja płytki skrawającej



7. Ustawić wymiar końcowy zgodnie z oznakowaniem na kasecie i wyzerować czujnik.



8. Umieścić czujnik w najwyższym punkcie płytki skrawającej TEC. Obracać śrubę regulacyjną w kierunku zgodnym z ruchem wskazówek zegara, aż wskazówka zegara będzie wskazywać zero.

Montaż



9. Włożyć kasetę do gniazda. Lekko dokręcić obie śruby mocujące TORX®. Następnie dokręcić śruby mocujące TORX® momentem 2,8 Nm.

Wyszukiwanie i rozwiązywanie problemów – narzędzia do rozwiercania precyzyjnego i rozwiertaki stałe

Brak okrągłości otworu – zjawisko nieregularne

Przyczyny		Rozwiązanie
Narzędzie do rozwiercania precyzyjnego	Rozwiertak wieloostrowy	
Ustawiony zbyt duży występ	-	Sprawdzić / wyregulować ustawienie narzędzia
-	fz za mały / vc za duża	Wyregulować parametry skrawania (zalecenia – patrz katalog)
Za duże wyprzedzanie		Sprawdzić wyprzedzanie



Brak okrągłości otworu – zjawisko powtarzalne

Przyczyny		Rozwiązanie
Narzędzie do rozwiercania precyzyjnego	Rozwiertak wieloostrowy	
Element zamocowany (typowy wieloboczny uchwyt szczękowy)		Sprawdzić zespół / docisk
Element o niesymetrycznych przekrojach poprzecznych		Zmniejszyć ciśnienie skrawania (większe pochylenie, mniejsza liczba ostrzy, bardziej stromy nakrój, mniejszy posuw)



Otwór za duży

Przyczyny		Rozwiązanie
Narzędzie do rozwiercania precyzyjnego	Rozwiertak wieloostrowy	
Błąd bicia zbyt duży		Sprawdzić bicie / zastosować adapter centrujący
Niewłaściwe pozycjonowanie		Sprawdzić położenie otworu
Narost		Zwiększyć vc, sprawdzić chłodziwo / sprawdzić dobór materiału skrawającego / sprawdzić dobór nakroju (zalecenia – patrz katalog)
Wibracje / stukanie		Wyregulować parametry skrawania / naddatek (zalecenia – patrz katalog)
Zbyt duży występ	-	Sprawdzić / skorygować ustawienie średnicy
-	Niewłaściwa średnica narzędzia	Sprawdzić średnicę

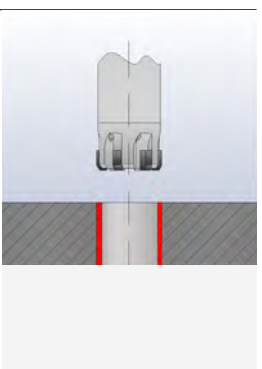

Otwór za mały

Przyczyny		Rozwiązanie
Narzędzie do rozwiercania precyzyjnego	Rozwiertak wieloostrowy	
Zużycie ostrza/ostrzy		Wymienić / ponownie przeszlifować
Sprawdzić głębokość skrawania ap (obróbka wstępna)		Wyregulować głębokość skrawania, zalecenia – patrz katalog
Element cienkościenny (odkształcenie sprężyste elementu)		Zmniejszyć siły skrawania (zwiększyć pochylenie, zmniejszyć liczbę ostrzy, bardziej stromy nakrój, mniejszy posuw)
Zbyt mały występ	-	Sprawdzić / wyregulować ustawienie

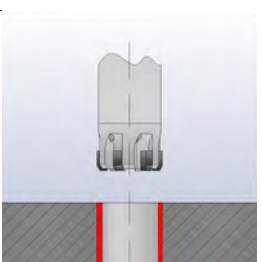

Włot otworu stożkowy | Wylot otworu stożkowy

Przyczyny		Rozwiązanie
Narzędzie do rozwiercania precyzyjnego	Rozwiertak wieloostrowy	
Błąd bicia zbyt duży		Sprawdzić bicie / zastosować adapter centrujący
Problem pozycjonowania / przesunięcie osi		Sprawdzić pozycję obróbki wstępnej lub prostoliniowość osi
-	Zbyt duże przekroczenie długości otworu	maks. długość nakroju + długość otworu przekroczone o 1 mm na wylocie
Za duże wyprzedzanie	-	Sprawdzić wyprzedzanie
Za wysokie ciśnienie chłodziwa		Obniżyć ciśnienie chłodziwa

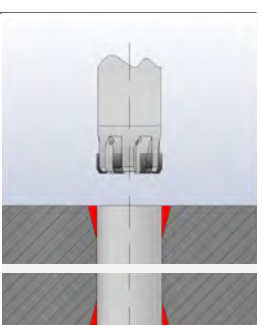

Nieprawidłowa powierzchnia otworu – zjawisko nieregularne

Przyczyny		Rozwiązanie	
Narzędzie do rozwiercania precyzyjnego	Rozwiertak wieloostrowy		
Narost / wykruszenia		Sprawdzić, w razie potrzeby wymienić narzędzie/ostrza Parametry skrawania – patrz zalecenia w katalogu	
Za mały naddatek		Sprawdzić obróbkę wstępną i naddatek	
brak smarowania / chłodzenia		Sprawdzić dopływ chłodziwa / MMS i zawartość oleju Sprawdzić dobór chłodziwa / dodatku do danej obróbki	
Zakłócone usuwanie wiórów Zużycie		Zwiększyć ciśnienie chłodziwa / zmienić geometrię ostrza Wymiana ostrzy/narzędzia	
Niewyważenie		Sprawdzić, czy kombinacja chwytu/adaptera i narzędzia jest odpowiednio wyważona	

Nieprawidłowa powierzchnia otworu – zjawisko regularne

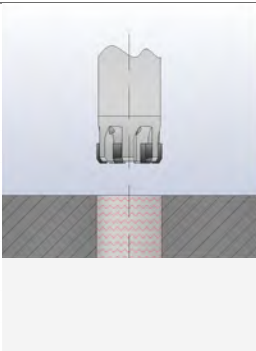
Przyczyny		Rozwiązanie	
Narzędzie do rozwiercania precyzyjnego	Rozwiertak wieloostrowy		
Przesunięcie osi / niewłaściwe pozycjonowanie fz za mały / vc za duża		Sprawdzić przesunięcie i położenie otworu Wyregulować parametry skrawania (zalecenia – patrz katalog)	
krytyczny stosunek średnicy do długości		Sprawdzić krytyczny stosunek średnicy do długości	
Oddziaływanie wrzeciona i jednostki napędowej		Zmienić parametry skrawania, sprawdzić dobór nakroju (zalecenia – patrz katalog)	
Niewyważenie		Czy kombinacja chwytu/adaptera i narzędzia jest odpowiednio wyważona?	
Za małe pochylenie		sprawdzić / wyregulować	
Zbyt duży występ		sprawdzić / wyregulować	

Nieprawidłowy przebieg otworu / kształt walcowy

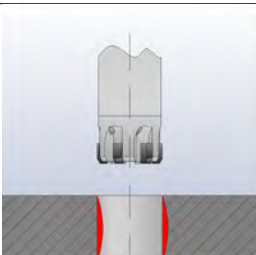
Przyczyny		Rozwiązanie	
Narzędzie do rozwiercania precyzyjnego	Rozwiertak wieloostrowy		
Wadliwa obróbka wstępna		Konsultacja z działem specjalistycznym / specjalistą ds. produktu Sprawdzić / wyregulować	
Nieodpowiednia geometria nakroju lub narzędzie		Konsultacja z działem specjalistycznym / specjalistą ds. produktu	
Niewłaściwa strategia obróbki		Konsultacja z działem specjalistycznym / specjalistą ds. produktu	

Całkowite wyłamanie nakroju – zjawisko ogólne Konsultacja ze specjalistą ds. produktu / pracownikiem MAPAL

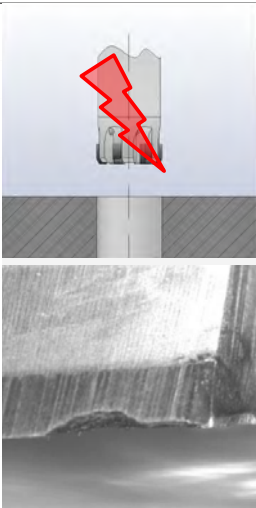
Przyczyny		Rozwiązanie	
Narzędzie do rozwiercania precyzyjnego	Rozwiertak wieloostrowy		
Usuwanie wiórów		Zwiększyć ciśnienie chłodziwa / geometria ostrza	
Za duże / za małe pochylenie		sprawdzić / wyregulować	
Za duży naddatek ap		sprawdzić / zmienić	
Zbyt silne zużycie		Wymiana ostrzy/narzędzia	
Wibracje		Ustalić i wyeliminować przyczynę	
Nieprawidłowe parametry skrawania		Wyregulować parametry skrawania (zalecenia – patrz katalog)	
Za duże wyprzedzanie		W razie potrzeby zmniejszyć wyprzedzanie	

Ogólne wzory dotyczące obróbki skrawaniem – powiercanie

Prędkość i posuw

Prędkość obrotowa	$n = \left[\frac{1}{\text{min}} \right]$	$n = \frac{v_c \cdot 1000}{\pi \cdot D_c}$
Prędkość skrawania	$v_c = \left[\frac{\text{m}}{\text{min}} \right]$	$v_c = \frac{\pi \cdot D_c \cdot n}{1000}$
Prędkość posuwu	$v_f = \left[\frac{\text{mm}}{\text{min}} \right]$	$v_f = f_z \cdot z \cdot n$
Posuw na ostrze	$f_z = \left[\text{mm} \right]$	$f_z = \frac{v_f}{z \cdot n}$
Posuw	$f = \left[\text{mm} \right]$	$f = f_z \cdot z$
Liczba ostrzy	z	

Siła skrawania

Siła skrawania F_c	$F_c = A \cdot k_c = b \cdot h \cdot k_c$	F_c w N k_c w N/mm^2
Specyficzna siła skrawania	$k_c = \left[\frac{k_c \cdot 1.1}{h \cdot \text{mc}} \right]$	

Parametry wióra – powiercanie

Oprócz właściwej siły skrawania materiału obrabianego, o sile skrawania decyduje zasadniczo przekrój wióra A.

Istotne wielkości stanowią w tym zakresie: posuw na ostrze f_z i głębokość skrawania a_p .

Obowiązują następujące zależności:

Posuw	$f = [\text{mm}]$	$f = f_z \cdot z$
Kąt przystawienia	$\kappa = [^\circ]$	$\kappa = \frac{\sigma}{2}$
Szerokość wióra	$b = [\text{mm}]$	$b = \frac{a_p}{\sin \kappa}$
Grubość wióra	$h = [\text{mm}]$	$h = f_z \cdot \sin \kappa$
Głębokość skrawania	$a_p = [\text{mm}]$	$a_p = \frac{(D - d)}{2}$

Na rysunku przedstawiono przekrój wióra A podczas nawiercania.

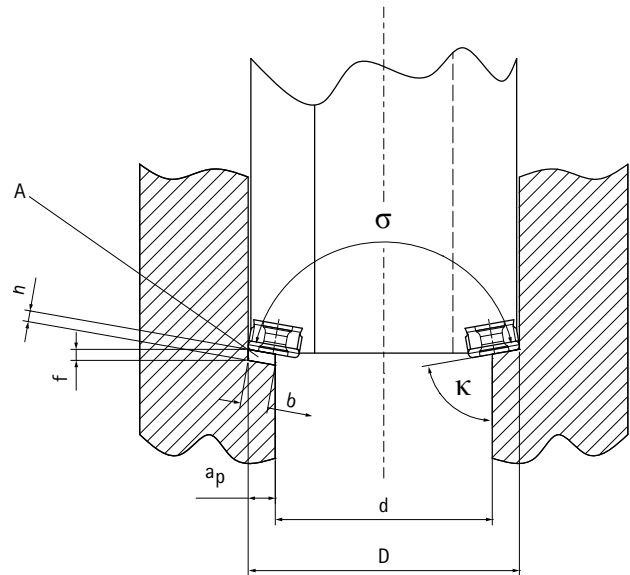

Przekrój wióra podczas nawiercania	$A = [\text{mm}^2]$	$A = \frac{(D - d) \cdot f_z}{2}$	lub	$A = a_p \cdot f_z$
------------------------------------	---------------------	-----------------------------------	-----	---------------------

Obliczenie siły skrawania – powiercanie

W uproszczeniu

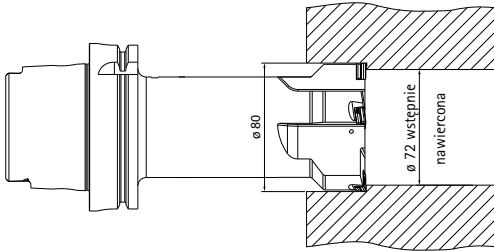

Przykład obliczeń:

Nawiertak $\varnothing 80$ mm;
 $Z = 5$; wstępnie nawiercona $\varnothing 72$ mm,
 $\kappa = 90^\circ$

Materiał: EN-GJL-250
 $k_{c1.1^*} = 1160$, $M_c = 0,26$
 $v_c = 200$ m/min, $f_z = 0,2$ mm
 Stępienie 30%

	Wzór podstawowy	Obliczenie	Wynik
1. Prędkość obrotowa	$n = \frac{V_c \cdot 1000}{\pi \cdot D}$	$n = \frac{200 \cdot 1000}{\pi \cdot 80}$	$n = 800$ 1/min
2. Głębokość skrawania	$a_p = \frac{(D - d)}{2}$	$a_p = \frac{(80 - 72)}{2}$	$a_p = 4$ mm
3. Przekrój wióra	$A = a_p \cdot f \cdot z$	$A = 4 \text{ mm} \cdot 0,2 \text{ mm} \cdot 5$	$A = 4$ mm ²
4. Grubość wióra	$h = f_z \cdot \sin \kappa$	$h = 0,2 \text{ mm} \cdot \sin 90^\circ$	$h = 0,2$ mm
5. Specyficzna siła skrawania bez wskaźnika stępienia	$k_c = \frac{k_{c1.1}}{h^{m_c}}$	$k_c = \frac{1160}{0,2^{0,26}}$	$k_c = 1763$ N/mm ² ze stępieniem 30%: $1763 \text{ N/mm}^2 \times 1,3 = 2292 \text{ N/mm}^2$
6. Siła skrawania	$F_c = A \cdot k_c = b \cdot h \cdot k_c$	$F_c = 4 \text{ mm}^2 \cdot 2292 \text{ N/mm}^2$	$F_c = 9,17$ kN
7. Moment skrawania <small>d_m = przeciętna średnica w metrach</small>	$M_c = F_c \cdot \frac{d_m}{2}$	$M_c = 9167,3 \text{ N} \cdot \frac{0,076 \text{ m}}{2}$	$M_c = 348,3$ Nm
8. Wydajność skrawania	$P_c = \frac{2 \cdot \pi \cdot n \cdot M_c}{60s}$	$P_c = \frac{2 \cdot \pi \cdot 800 \text{ min}^{-1} \cdot 348,3 \text{ Nm}}{60s}$	$P_c = 29,2$ kW

* Wartość z obliczeń siły skrawania, WTO GmbH

Informacja: Nie uwzględniono sprawności napędu głównego wrzeciona.
 Istnieje możliwość skorzystania z odpowiednich obliczeń wydajności dokonanych przez MAPAL.

Wybór obrabiarki

Porównanie w oparciu o moment obrotowy i moc obrabiarki

Poniżej przedstawiamy dwa wykresy prędkości obrotowej/mocy. W zależności od maszyny należy ustalić liczbę ostrzy i parametry skrawania.

W przykładzie obliczeniowym maszyna z wrzecionem silnikowym nie jest odpowiednia, ponieważ w jej przypadku przy prędkości obrotowej 800 obr./min moment obrotowy wynosi tylko 187 Nm, a moc ok. 20 kW (rys. 1).

Rozwiązanie:
 Albo zmniejszyć liczbę ostrzy, obniżyć prędkość skrawania i posuw, podzielić skrawanie na dwa narzędzia, albo wybrać maszynę o większej mocy (np. z wrzecionem przekładniowym, rys. 2)

Wrzeciono z silnikiem (rysunek 1)

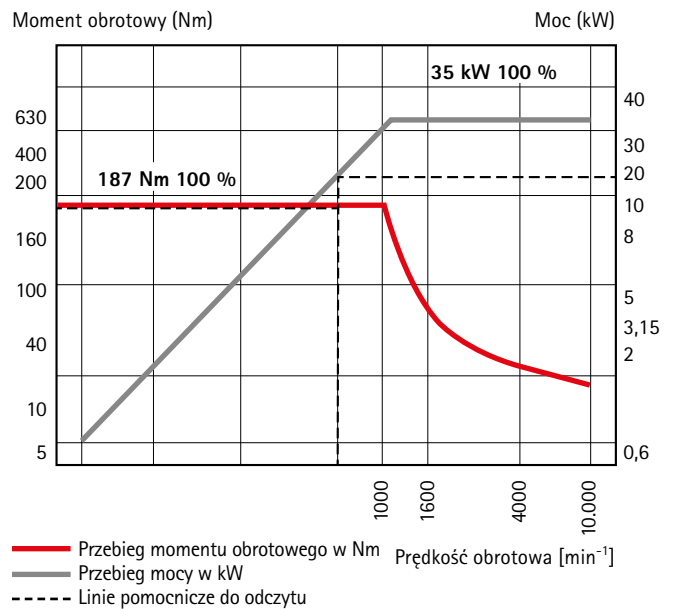

Wrzeciono z przekładnią (rysunek 2)

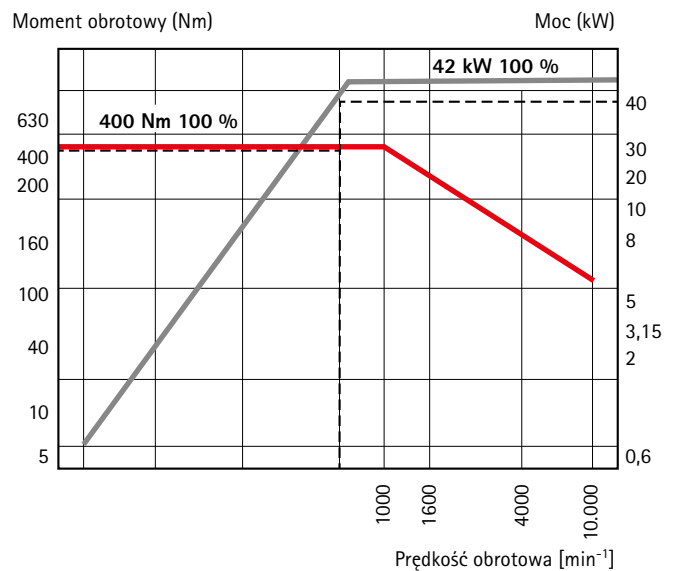

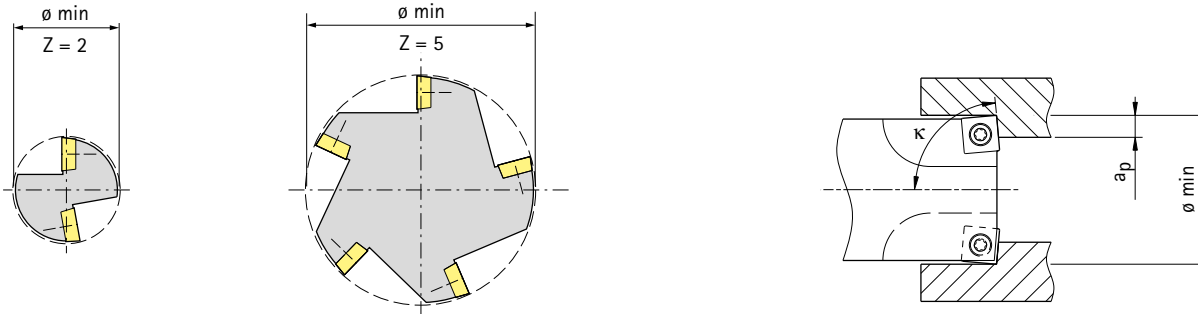

Wartości orientacyjne minimalnych średnic powiercania – płytki promieniowe

W zależności od liczby ostrzy i płytki skrawającej



Ostrza nawierające promieniowe szlifowane na ostro

Kształt WSP	Wielkość WSP				Liczba ostrzy	Uwagi
	0603	09T3	1204			
S (90°)	Minimalna średnica nawiercania przy κ 85°					Odpowiednie do wykonywania otworów przelotowych
	17	25	28		1	
	17	25	31		2	
	23	32	39		3	
	31	43	53		4	
	51	63	73		5	
C (80°)	0602	09T3	1204			Odpowiednie do obróbki krawędzi 90°
	Minimalna średnica nawiercania przy κ 90°					
	17	24	28		1	
	18	26	33		2	
	23	34	41		3	
	31	45	54		4	
49	63	77		5		
T (60°)	06T1	0902	1102	16T3		Warunkowo odpowiednie do wykonywania otworów przelotowych i obróbki krawędzi 90°
	Minimalna średnica nawiercania przy κ 90°					
	15	17	17	24	1	
	18	21	24	37	2	
	21	25	28	43	3	
	27	34	37	57	4	
37	51	67	76	5		

Wartości orientacyjne minimalnych średnic powiercania – płytki styczne

W zależności od liczby ostrzy i płytki skrawającej

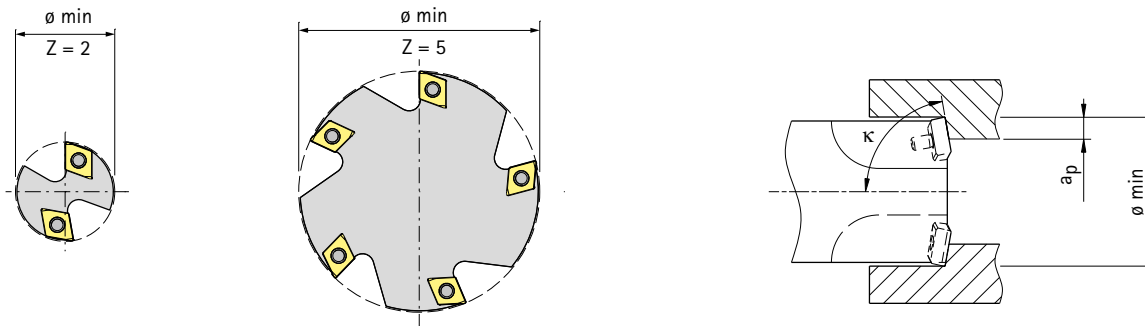

Ostrza nawierające styczne szlifowane na ostro

Kształt WSP	Wielkość WSP			Liczba ostrzy	Uwagi
	0603/0604	09T3/0905	1204/1206		
C (80°)	Minimalna średnica nawiercania przy κ 80° i 90°				
	28	41	54	1	Odpowiednie do wykonywania otworów przelotowych i obróbki krawędzi 90°
	28	41	54	2	
	30	41	54	3	
	40	56	64	4	
	59	84	94	5	

Ostrza nawierające styczne szlifowane szlifem okrągłym

Kształt WSP	Wielkość WSP			Liczba ostrzy	Uwagi
	0604	0905	1206		
C (80°)	Minimalna średnica nawiercania przy κ 80° i 90°				
	40	65	78	1	Odpowiednie do wykonywania otworów przelotowych i obróbki krawędzi 90°
	40	65	78	2	
	40	65	78	3	
	41	65	78	4	
	64	86	102	5	

Ostrza nawierające styczne szlifowane szlifem okrągłym i ostrym

Kształt WSP	Wielkość WSP			Liczba ostrzy	Uwagi
	0604	0905	1206		
F (70°)	Minimalna średnica nawiercania przy κ 80° i 90°				
	22	30	40	1	Odpowiednie do wykonywania otworów przelotowych i obróbki krawędzi 90°
	22	30	40	2	
	31	43	53	3	
	42	56	67	4	
	64	83	99	5	

Identyfikacja i rozwiązywanie problemów

Postacie zużycia płytek skrawających

Postać zużycia

Zużycie powierzchni przyłożenia

styczna

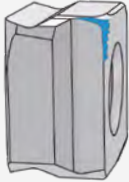

promieniowy

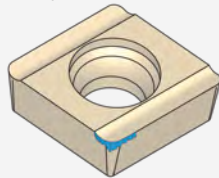

Zużycie rowkowe

styczna



promieniowy



Zużycie żłobkowe

styczna



promieniowy



Narost

styczna

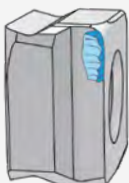

promieniowy

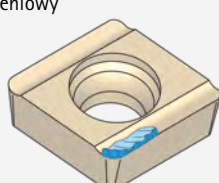

Wykruszenia

styczna

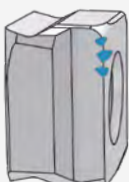

promieniowy



Pęknięcie ostrza

styczna

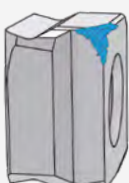

promieniowy



Działania zaradcze

- Obniżyć prędkość skrawania
- Wybrać bardziej odporny na zużycie rodzaj materiału skrawającego

- Zmniejszyć posuw
- Obniżyć prędkość skrawania
- Wybrać bardziej odporny na zużycie rodzaj materiału skrawającego
- Stosować chłodziwo

- Obniżyć prędkość skrawania
- Wybrać mniejszy kąt przystawienia
- Zmniejszyć posuw

- Zwiększyć prędkość skrawania
- Zwiększyć posuw
- Wybrać geometrię ułatwiającą skrawanie (ostre krawędzie skrawające)

- Zwiększyć prędkość skrawania
- Zmniejszyć posuw
- Wybrać bardziej ciągliwy gatunek węglik
- Wybrać silniejszą geometrię
- Poprawić stabilność (np. krótkie narzędzie)
- Chłodzenie, ciągłe lub suche (unikać szoku termicznego)

- Zmniejszyć posuw
- Zmniejszyć głębokość skrawania
- Wybrać silniejszą geometrię płytki skrawającej
- Wybrać bardziej ciągliwy gatunek węglik
- Wybrać grubszą płytkę skrawającą

Przykłady praktyczne – rozwiązywanie problemów podczas nawiercania

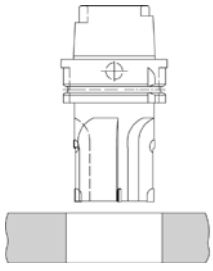
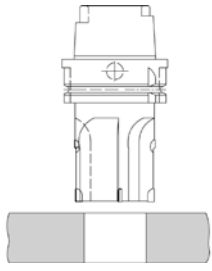
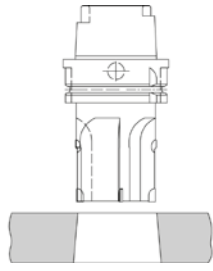
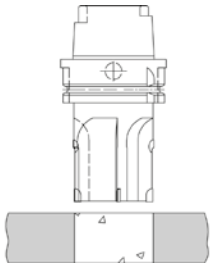
Otwór za duży	Otwór za mały	Stożkowy przebieg otworu	Nieprawidłowa powierzchnia otworu
<p>Przyczyna?</p> <ul style="list-style-type: none"> - Za duża średnica narzędzia - Za wysoka prędkość skrawania - Zbyt duży posuw - Błąd bicia zbyt duży - Nierównomierny nakrój - Nieodpowiednie chłodziwo 	<p>Przyczyna?</p> <ul style="list-style-type: none"> - Zużycie narzędzia - Za niska prędkość skrawania - Zbyt mały posuw - Obrabiany materiał ciągliwy, kurczy się po obróbce - Za mały naddatek 	<p>Przyczyna?</p> <ul style="list-style-type: none"> - Błąd bicia zbyt duży - Nieprawidłowy nakrój - Nieprawidłowa obróbka wstępna 	<p>Przyczyna?</p> <ul style="list-style-type: none"> - Nieodpowiednie chłodziwo - Narost na ostrzu - Tępe narzędzie lub wykruszenie ostrza - Nieprawidłowe usuwanie wiórów - Zbyt duże niewyważenie resztkowe
			

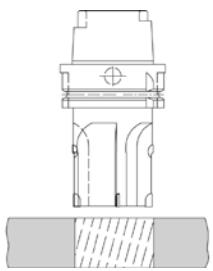
W otworze są odpryski	W otworze widoczne są rysy posuwowe	Zaokrąglony kształt otworu
<p>Przyczyna?</p> <ul style="list-style-type: none"> - Narost na ostrzu - Tępe narzędzie - Nieodpowiednie chłodziwo - Błąd bicia zbyt duży - Zbyt duże niewyważenie resztkowe - Nieprawidłowa konfiguracja zespołu 	<p>Przyczyna?</p> <ul style="list-style-type: none"> - Tępe narzędzie lub wykruszenie ostrza - Narost na ostrzu - Nieodpowiednie chłodziwo 	<p>Przyczyna?</p> <ul style="list-style-type: none"> - Nieprawidłowe zamocowanie obrabianego przedmiotu
		

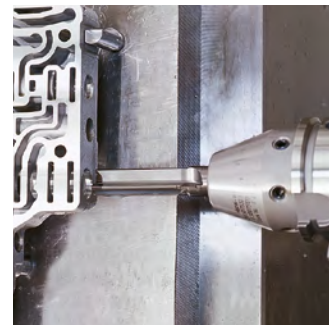

Piktogramy

Wiercenie w pełnym materiale

	Wiercenie w pełnym materiale		Nawiercanie		Wiertło stopniowe		Wiercenie głębokich otworów
	Wiercenie i rozwiercanie w jednym kroku roboczym		Obróbka z wysokim posuwem		Obróbka z dużą prędkością		Wiercenie otworów w pakietach
	Wiercenie poprzeczne		Skośny wlot otworu		Skośny wylot otworu		Płaskie dno otworu
	Otwór pod gwint		Otwór pilotujący		Maksymalna osiągalna tolerancja otworu $\geq IT$		Seria preferowana w tolerancji H7
	Tolerancja średnicy szlifowania narzędzia		Minimalna głębokość nawiercania *		Doprowadzenie chłodziwa		Złącze CFS
	Z płytką skrawającą		Miejsce podziału QTS		Złącze TTS-100		Złącze TTS-300
	Typ chwytu HA według DIN		Typ chwytu HB według DIN		Typ chwytu HE według DIN		

Rozwiercanie i rozwiercanie precyzyjne

	Otwór przelotowy		Otwór nieprzelotowy		Osiowy system mocowania HFS		Promieniowy system mocowania HFS
	Seria preferowana w tolerancji H7		Maksymalna osiągalna tolerancja otworu $\geq IT$		Tolerancja średnicy szlifowania narzędzia		Rozwiertak jednostrzowy
	Płytką skrawającą WP		Doprowadzenie chłodziwa		Złącze HFS		Złącze modułowe
	Złącze HSK-A		Złącze z chwytem stożkowym Morse'a (MK)		Chwył cylindryczny HA według DIN		Typ chwytu HE według DIN
	Chwył cylindryczny z powierzchnią mocującą						

Pogłębianie

	Pogłębiacze stożkowe wg DIN		Pogłębianie 90°
--	-----------------------------	--	-----------------

Konfiguracja

	Produkt z możliwością konfiguracji parametrów
--	---

Piktogramy

Klasa produktu



Basic Line:
Uniwersalne narzędzia, szeroki zakres zastosowań, niskie koszty nabycia



Performance Line:
Narzędzia wysoko wydajne, szeroki zakres zastosowania, zapewnia wysoką produktywność w produkcji seryjnej



Expert Line:
Narzędzia specjalistyczne do wybranych zastosowań, maksymalna precyzja i produktywność

Grupa materiałowa



 Wysoce przydatny

 Warunkowo przydatny

Przykład Standardowa tabela grupy materiałowej

P	1	2	3	4	5	6	M	1	2	3	K	1	2	3	N	1	2	3	4	S	1	2	3	4	5	H	1	2	3
																													

Przykład Tabela grupy materiałowej dla metali nieżelaznych i materiałów lekkich

N	1.1	1.2	1.3	1.4	2.1	2.2	2.3	3.1	4.1	4.2	4.3	G	1.1	1.2	1.3	2.1	3.1	4.1	4.2	5.1	5.2	5.3
																						

Grupa materiałowa wg MAPAL

Grupa materiałowa		Materiał obrabiany	Wytrzymałość/ twardość [N/mm ²] [HRC]	Często obrabiane materiały	
P	P1	P1.1	Stale konstrukcyjne, użytkowe i uszlachetnione, stale niestopowe	< 700 N/mm ²	1.0122 (S235/St 37), 1.0401 (C15), 1.0503 (C45), 1.0570 (S355/St 52), 1.1213 (Cf53)
		P1.2	Stale konstrukcyjne, użytkowe i uszlachetnione, stale niestopowe	< 1200 N/mm ²	1.1249 (Cf70)
	P2	P2.1	Stale azotowane, użytkowe i uszlachetnione, stale stopowe	< 900 N/mm ²	1.7131 (16MnCr5)
		P2.2	Stale azotowane, użytkowe i uszlachetnione, stale stopowe	< 1400 N/mm ²	1.7227 (42CrMoS4)
	P3	P3.1	Stale narzędziowe, łożyskowe, sprężynowe i stale szybko tnące*	< 800 N/mm ²	1.2343 (X37CrMoV5-1), 1.2762 (75CrMoNiW6-7)
		P3.2	Stale narzędziowe, łożyskowe, sprężynowe i stale szybko tnące*	< 1000 N/mm ²	1.2367 (X38CrMoV5-3), 1.2713 (55NiCrMoV6)
		P3.3	Stale narzędziowe, łożyskowe, sprężynowe i stale szybko tnące*	< 1500 N/mm ²	1.2379 (X153CrMoV12), 1.2738 (40CrMnNiMo8-6-4)
	P4	P4.1	Stale nierdzewne, ferrytyczne i martenzytyczne		1.4510 (X3CrTi17), 1.4589 (X5CrNiMoTi15-2)
P5	P5.1	Staliwo		1.7231 (G42CrMo4)	
P6	P6.1	Staliwo nierdzewne, ferrytyczne i martenzytyczne			
M	M1	M1.1	Stale nierdzewne, austenityczne	< 700 N/mm ²	1.4301 (V2A), 1.4571 (V4A)
		M1.2	Stale nierdzewne, ferrytyczne/austenityczne (Duplex)	< 1000 N/mm ²	1.4362 (Alloy 2304), 1.4501, 1.4662 (LDX 2404)
	M2	M2.1	Staliwo nierdzewne, austenityczne	< 700 N/mm ²	
M3	M3.1	Staliwo nierdzewne, ferrytyczne/austenityczne (Duplex)	< 1000 N/mm ²		
K	K1	K1.1	Żeliwo z grafitem płatkowym (żeliwo szare), GJL	< 300 N/mm ²	GJL-250 (GG-25), GJL-260 (GG-26 Cr)
		K2.1	Żeliwo sferoidalne, GJS	< 500 N/mm ²	GJS-400 (GGG-40), GJS-450 (GGG-45)
		K2.2	Żeliwo sferoidalne, GJS	≤ 800 N/mm ²	GJS-600 (GGG-60), GJS-800-2 (GGG-80), GJS-800-8 (ADI 800)
	K2	K2.3	Żeliwo sferoidalne, GJS	> 800 N/mm ²	GJS-900-2 (GGG-90), GJS-1000-5 (ADI 1000), GJS-1200-2 (ADI 1200), GJS-1400-1 (ADI 1400)
		K3.1	Żeliwo wermikularne, GJV, (żeliwo ciągliwe), GJL	< 500 N/mm ²	GJV-300, GJV-400, GJMW-400-5 (GTW-40)
	K3.2	Żeliwo wermikularne, GJV, (żeliwo ciągliwe), GJL	> 500 N/mm ²	GJV-500, GJV-700	
N	N1	N1.1	Aluminium, niestopowe i stopowe < 3 % Si		Alloy 2024, Alloy 7075, Al99
		N1.2	Aluminium, stopowe ≤ 7 % Si		AlSi7
		N1.3	Aluminium, stopowe > 7-12 % Si		AlSi9, AlSi9Cu
		N1.4	Aluminium, stopowe > 12 % Si		AlSi12, AlSi17
	N2	N2.1	Miedź, niestopowa i niskostopowa	< 300 N/mm ²	SE-Cu
		N2.2	Miedź, stopowa	> 300 N/mm ²	CuSn6
		N2.3	Mosiądz, brąz, spiż	< 1200 N/mm ²	CuZn33, CuAl9Mn3
	N3	N3.1	Grafit, > 8 μm		
		N3.2	Grafit, ≤ 8 μm		
	N4	N4.1	Tworzywo sztuczne, materiały termoplastyczne		PA, PE, PC, PS, PVC, PP, PTFE, POM, PMMA
		N4.2	Tworzywo sztuczne, duroplast		PU, PF, EP, UP, VE, CR
		N4.3	Tworzywo sztuczne, pianki		EPS, PUR, PVC-E, PS-E, PP-E
C	C1	C1.1	Matryca z tworzywa sztucznego, wzmacnianego włóknem aramidowym (AFK)		Nomex, Kevlar, Twaron, KOREX
		C1.2	Matryca z tworzywa sztucznego (duroplastycznego), CFK/GFK		IMS, HTA
		C1.3	Matryca z tworzywa sztucznego (termoplastycznego), CFK/GFK		GMT-PP, PEEK
	C2	C2.1	Matryca węglowa, wzmacniana włóknem węglowym (CFC)		CF222, CF225, CF226, CF227, CF260
		C3.1	Matryca metalowa (MMC)		CeramTec AO-403 (AlSi9MgMn-Al2O3), Al/Cu/Mg-SiO2/Al2O3/AlN/TiC/SiC/BN/TiB2
	C4	C4.1	Konstrukcja typu sandwich, rdzeń w formie plastra miodu (Honeycomb)		
		C4.2	Konstrukcja typu sandwich, rdzeń piankowy		PLASCORE PAMG-XR1 5052, PCGA-XR1 3003, PAMG-XR1 5056, Micro-Cell (core made of Alloy 5052/5056)
	C5	C5.1	Połączenie warstwowe (Stack), połączenie niemetal-metal nieżelazny		CFK-Aluminium, IMS/HTA + Alloy 2024/6061/7075
		C5.2	Połączenie warstwowe (Stack), połączenie niemetal-metal		CFK-Titan, IMS/HTA + TiAl6V4/AMS4905
		C5.3	Połączenie warstwowe (Stack), połączenie niemetal-niemetal		CFK-CFK
C5.4		Połączenie warstwowe (Stack), połączenie metal nieżelazny-metal nieżelazny		Aluminium-aluminium	
C5.5		Połączenie warstwowe (Stack), połączenie metal-metal nieżelazny		Aluminium-tytan	
C5.6		Połączenie warstwowe (Stack), połączenie metal-metal		Tytan-Inox	
S	S1	S1.1	Tytan, stopy tytanu	< 400 N/mm ²	
		S2.1	Tytan, stopy tytanu	< 1200 N/mm ²	TiAl6V4
	S2	S2.2	Tytan, stopy tytanu	> 1200 N/mm ²	
		S3.1	Nikiel, niestopowy i stopowy	< 900 N/mm ²	1.3912 (Invar, Ni36)
	S3	S3.2	Nikiel, niestopowy i stopowy	> 900 N/mm ²	
		S4.1	Nadstop o wysokiej odporności termicznej na bazie Ni, Co i Fe		Hardox, Hastelloy, Incoloy, Inconel, NIMONIC, Stellite, Waspaloy
S5	S5.1	Stopy wolframu i molibdenu			
H	H1	H1.1	Stal utwardzana/staliwo	< 44 HRC	1.2738 HH, 1.2085, Toolox 33, Toolox 44
		H1.2	Stal utwardzana/staliwo	< 55 HRC	1.2343, 1.2311, 1.2312, 1.2714, 1.2083, 1.2738
	H2	H2.1	Stal utwardzana/staliwo	< 60 HRC	1.1730, 1.2379, 1.2358, 1.2767, 1.4112, ASP 2012
		H2.2	Stal utwardzana/staliwo	< 65 HRC	1.2379, 1.2363, 1.2436, 1.2842, ASP 2005, Vanadis 23
	H3	H2.3	Stal utwardzana/staliwo	< 68 HRC	ASP 2017, ASP 2023, Vanadis 30, Vanadis 60
		H3.1	Żeliwo / żeliwo utwardzone, odporne na ścieranie, GJN		

* Jeśli składniki stopu Cr, Mo, Ni, V, W wynoszą łącznie > 8%, należy wybrać następną w kolejności grupę materiałową MAPAL.



Warto odkryć już teraz rozwiązania w zakresie narzędzi i usług, które pomogą w takich pracach, jak:

OBRÓBKA OTWORÓW

ROZWIERCANIE | ROZWIERCANIE PRECYZYJNE

WIERCENIE W PEŁNYM MATERIALE | NAWIERCANIE | POGŁĘBIANIE

FREZOWANIE

TECHNIKA MOCOWANIA

TOCZENIE

NARZĘDZIA MECHATRONICZNE

USTAWIENIA | POMIARY | WYDAWANIE NARZĘDZI

USŁUGI