



Your technology partner for cost-effective machining

OptiMill[®]-Tro-Inox

OptiMill®-Tro-Inox

Six-flute trochoidal milling cutter for milling in stainless steel

The specific kinematics of trochoidal milling makes it possible to positively influence the engagement conditions due to a superimposition of the feed movement with a circular movement of the tool.

The specific kinematics of trochoidal milling make it possible to positively influence the engagement conditions due to the superimposition of the feed movement with a circular movement of the tool.

The pressure angle is correspondingly low. This technological approach has the consequence that a reduced chip width and cutting length lead to significantly reduced process forces.

1 Front geometry

- Five cutting edges
- Diameter 6.00 mm - 25.00 mm
- Cutting material HP826

2 Spiral angles

- Spiral angle 36°
- Unequal pitch
- Specially adapted spiral angles to the length ratio of 3xD for a reduction of the pull-out forces

3 Carbide & Coating

- Tough tungsten carbide for highly dynamic loads
- AlTiN based multilayer coating for ideal thermal stability

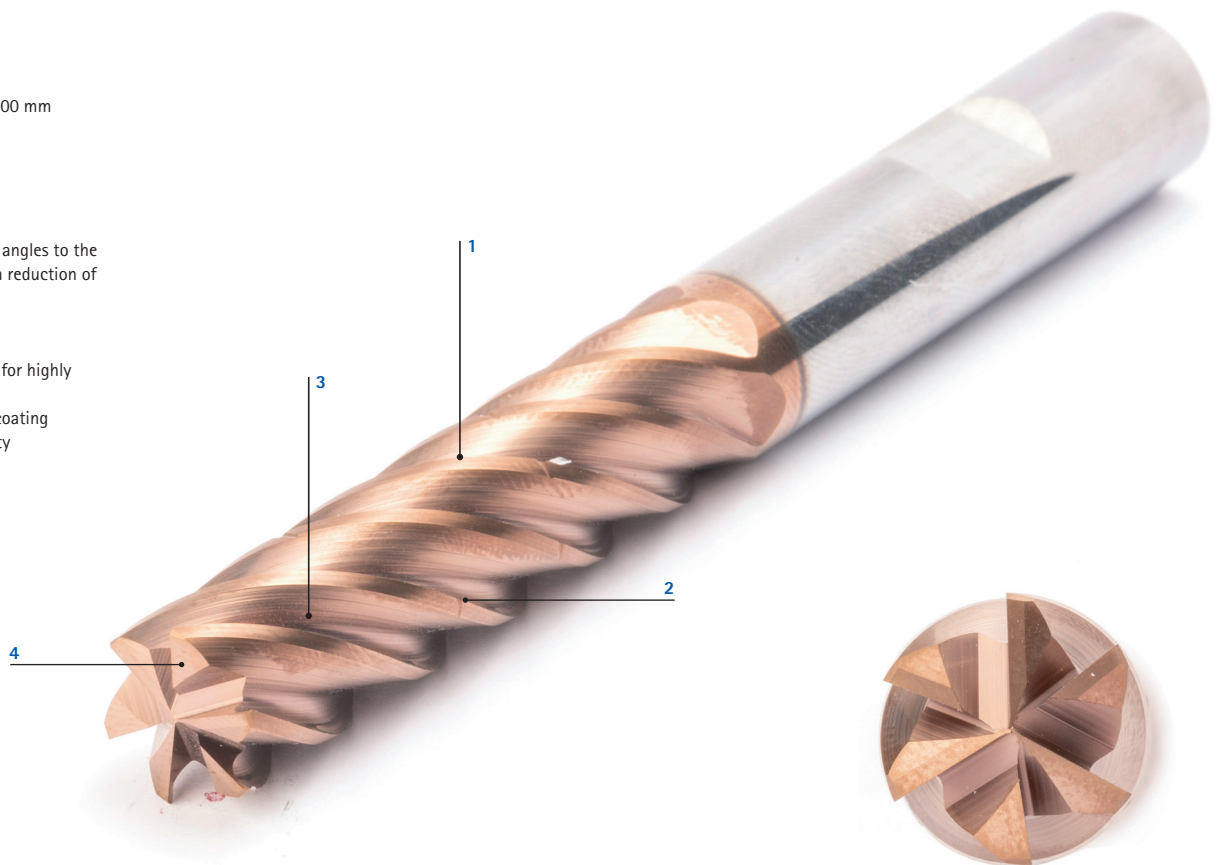

Features

- Preferred series in stock:
 - ø range: 4 mm to 20 mm
- On request
 - ø range: 14, 18 and 25 mm
- Number of cutting edges 6
- Unequal pitch
- Especially for trochoidal milling
- For cutting depths up to 5xD

Comparison of the maximum cutting volume up to the end of the tool life

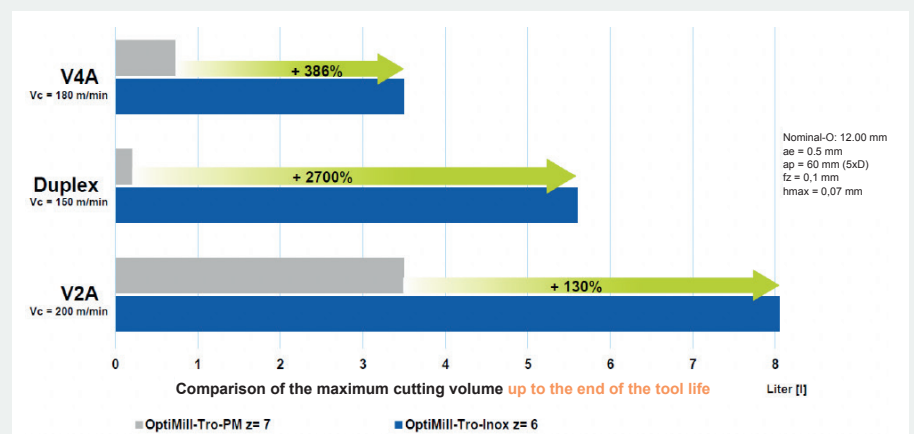

OptiMill®-Tro-Inox

Shoulder milling cutter, 2xD design with neck, includes chip breaker
SCM292

Design:

Diameter of milling cutter: 4,00 – 25,00 mm
Cutting material: HP826
Number of cutting edges: 6
Helix angle: 36°
Special features: Cutting edge portion balanced on G2.5 according to DIN ISO 1940-G2.5

Application:

Design with chip breaker for optimum chip control. Ensures chips are shortened.

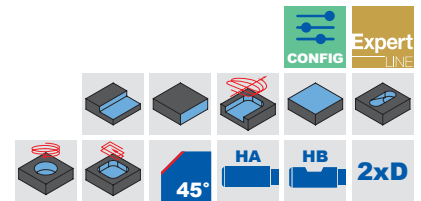
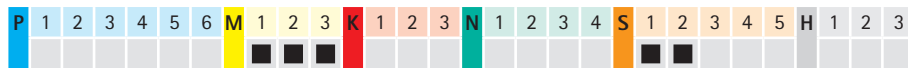
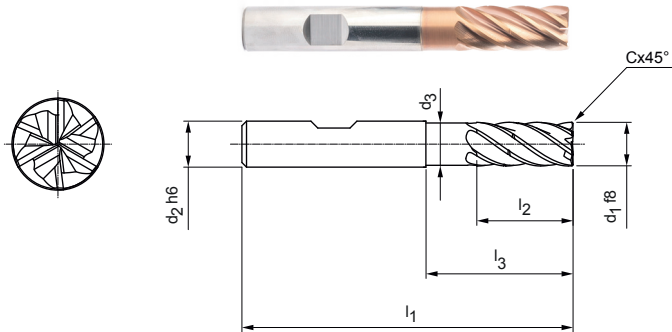

Preferred series in stock

Dimensions							z	Chip breaker	Shank form HB	
d ₁ f8	d ₂ h6	d ₃	l ₁	l ₂	l ₃	C x 45°			Specification	Order no.
4,00	6	3,9	57	11	13	0,08	6	–	SCM292-0400Z06R-F0008HB2-HP826	31348624
5,00	6	4,8	57	13	15,5	0,1	6	–	SCM292-0500Z06R-F0010HB2-HP826	31348625
6,00	6	5,8	57	13	19	0,12	6	–	SCM292-0600Z06R-F0012HB2-HP826	31348626
8,00	8	7,8	63	19	25	0,16	6	–	SCM292-0800Z06R-F0016HB2-HP826	31348627
10,00	10	9,8	72	22	30	0,2	6	–	SCM292-1000Z06R-F0020HB2-HP826	31348628
12,00	12	11,8	83	26	36	0,24	6	1	SCM292-1200Z06R-F0024HB2-HP826	31348629
16,00	16	15,8	92	32	42	0,32	6	1	SCM292-1600Z06R-F0032HB2-HP826	31348631
20,00	20	19,8	104	41	52	0,4	6	1	SCM292-2000Z06R-F0040HB2-HP826	31348633

Available on request

14,00	14	13,8	83	26	36	0,28	6	1	SCM292-1400Z06R-F0028HB2-HP826	31348630
18,00	18	17,8	92	32	42	0,36	6	1	SCM292-1800Z06R-F0036HB2-HP826	31348632
25,00	25	24,5	125	50	65	0,5	6	1	SCM292-2500Z06R-F0050HB2-HP826	31348634

Configurable features



Shank form:
Shank form: HA



Specification:
SCM292-0400Z06R-F0008[shank form]2-HP826

Example:

SCM292-0400Z06R-F0008HA2-HP826

Shank form HA

Dimensions in mm.

For cutting data recommendations, see end of the document.

Special designs and other coatings available upon request.

OptiMill®-Tro-Inox

Shoulder milling cutter, 3xD design with neck, includes chip breaker
SCM292

Design:

Diameter of milling cutter: 4,00 – 25,00 mm
Cutting material: HP826
Number of cutting edges: 6
Helix angle: 36°
Special features: Cutting edge portion balanced on G2.5 according to DIN ISO 1940-G2.5

Application:

Design with chip breaker for optimum chip control. Ensures chips are shortened.

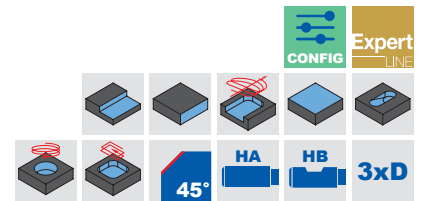
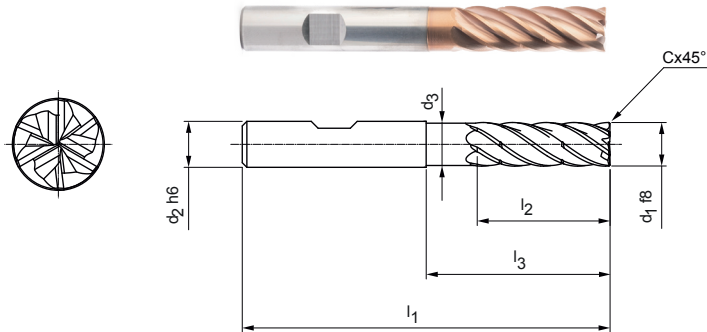

Preferred series in stock

Dimensions							z	Chip breaker	Shank form HB	
d ₁ f8	d ₂ h6	d ₃	l ₁	l ₂	l ₃	C x 45°			Specification	Order no.
4,00	6	3,9	62	16	23	0,08	6	1	SCM292-0400Z06R-F0008HB3-HP826	31348635
5,00	6	4,8	62	17	24	0,1	6	1	SCM292-0500Z06R-F0010HB3-HP826	31348636
6,00	6	5,8	62	18	25	0,12	6	1	SCM292-0600Z06R-F0012HB3-HP826	31348637
8,00	8	7,8	68	24	30	0,16	6	1	SCM292-0800Z06R-F0016HB3-HP826	31348638
10,00	10	9,8	80	30	35	0,2	6	1	SCM292-1000Z06R-F0020HB3-HP826	31348639
12,00	12	11,8	93	36	45	0,24	6	2	SCM292-1200Z06R-F0024HB3-HP826	31348640
14,00	14	13,8	99	42	50	0,28	6	2	SCM292-1400Z06R-F0028HB3-HP826	31348641
16,00	16	15,8	108	48	55	0,32	6	2	SCM292-1600Z06R-F0032HB3-HP826	31348642
20,00	20	19,8	126	60	70	0,4	6	2	SCM292-2000Z06R-F0040HB3-HP826	31348644

Available on request

18,00	18	17,8	117	54	67	0,36	6	2	SCM292-1800Z06R-F0036HB3-HP826	31348643
25,00	25	24,5	150	75	92	0,5	6	2	SCM292-2500Z06R-F0050HB3-HP826	31348645

Configurable features



Shank form:
Shank form: HA



Specification:
SCM292-0400Z06R-F0008[shank form]3-HP826

Example:

SCM292-0400Z06R-F0008HA3-HP826

Shank form HA

Dimensions in mm.

For cutting data recommendations, see end of the document.

Special designs and other coatings available upon request.

OptiMill®-Tro-Inox

Shoulder milling cutter, 3xD design with neck, includes chip breaker, with internal coolant supply SCM291

Design:

Diameter of milling cutter: 6,00 – 20,00 mm
 Cutting material: HP826
 Number of cutting edges: 6
 Helix angle: 36°
 Special features: Unequal division / unequal gradient

Application:

Version with chip divider and central internal cooling for optimum chip control. Ensures shortened chips.

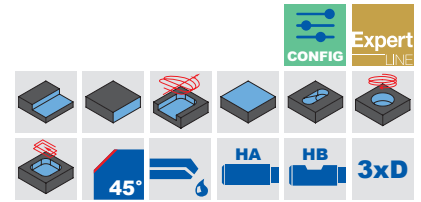
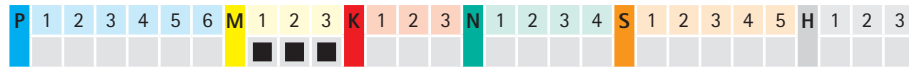
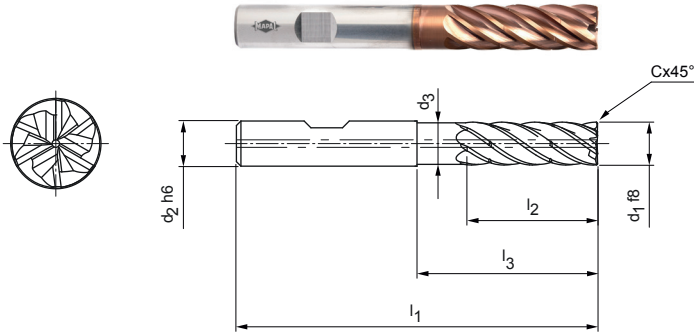

Preferred series in stock

Dimensions							z	Chip breaker	Shank form HB	
d ₁ f8	d ₂ h6	d ₃	l ₁	l ₂	l ₃	C x 45°			Specification	Order no.
6,00	6	5,8	62	18	25	0,12	6	1	SCM291-0600Z06R-F0012HB3-HP826	31504982
8,00	8	7,8	68	24	30	0,16	6	1	SCM291-0800Z06R-F0016HB3-HP826	31504983
10,00	10	9,8	80	30	35	0,20	6	1	SCM291-1000Z06R-F0020HB3-HP826	31504984
12,00	12	11,8	93	36	45	0,24	6	2	SCM291-1200Z06R-F0024HB3-HP826	31504985
16,00	16	15,8	108	48	55	0,32	6	2	SCM291-1600Z06R-F0032HB3-HP826	31504986
20,00	20	19,8	126	60	70	0,40	6	2	SCM291-2000Z06R-F0040HB3-HP826	31504987

Configurable features

Shank form:
Shank form: HA

Specification:
SCM291-1200Z06R-F0024[shank form]3-HP826

Example:

SCM291-1200Z06R-F0024HA3-HP826



Dimensions in mm.

For cutting data recommendations, see end of the document.

Special designs and other coatings available upon request.

OptiMill®-Tro-Inox

Shoulder milling cutter, 4xD design, with chip breaker
SCM292

Design:

Diameter of milling cutter: 5,00 – 25,00 mm
Cutting material: HP826
Number of cutting edges: 6
Helix angle: 36°
Special features: Cutting edge portion balanced on G2.5 according to DIN ISO 1940-G2.5

Application:

Design with chip breaker for optimum chip control. Ensures chips are shortened.

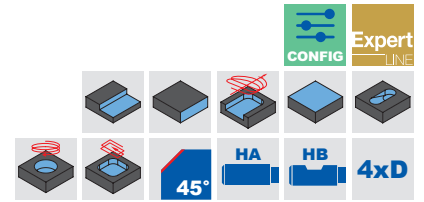
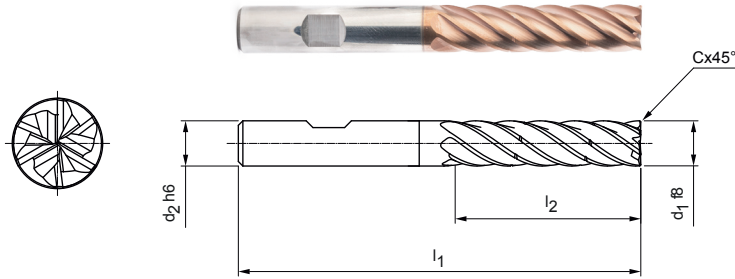

Preferred series in stock

Dimensions					z	Chip breaker	Shank form HB	
d ₁ f8	d ₂ h6	l ₁	l ₂	C x 45°			Specification	Order no.
5,00	6	66	20	0,10	6	2	SCM292-0500Z06R-F0010HB4-HP826	31348646
6,00	6	66	24	0,12	6	2	SCM292-0600Z06R-F0012HB4-HP826	31348647
8,00	8	74	32	0,16	6	2	SCM292-0800Z06R-F0016HB4-HP826	31348648
10,00	10	89	40	0,20	6	2	SCM292-1000Z06R-F0020HB4-HP826	31348649
12,00	12	100	48	0,24	6	2	SCM292-1200Z06R-F0024HB4-HP826	31348650
16,00	16	123	64	0,32	6	2	SCM292-1600Z06R-F0032HB4-HP826	31348652
20,00	20	140	80	0,40	6	2	SCM292-2000Z06R-F0040HB4-HP826	31348654

Available on request

14,00	14	108	56	0,28	6	2	SCM292-1400Z06R-F0028HB4-HP826	31348651
18,00	18	130	72	0,36	6	2	SCM292-1800Z06R-F0036HB4-HP826	31348653
25,00	25	170	100	0,5	6	2	SCM292-2500Z06R-F0050HB4-HP826	31348655

Configurable features



Shank form:
Shank form: HA



Specification:
SCM292-0500Z06R-F0008[shank form]4-HP826

Example:

SCM292-0500Z06R-F0008HA4-HP826



Dimensions in mm.

For cutting data recommendations, see end of the document.

Special designs and other coatings available upon request.

OptiMill®-Tro-Inox

Shoulder milling cutter, 5xD design, with chip breaker
SCM292

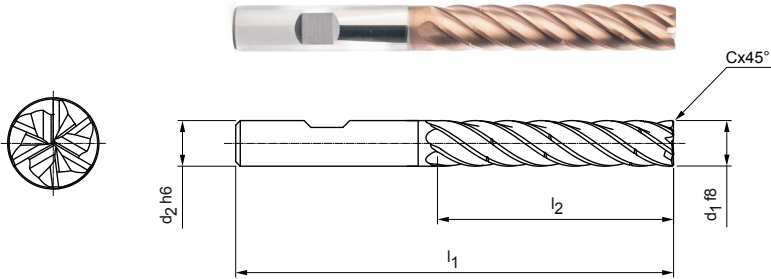

Design:

Diameter of milling cutter: 8,00 – 25,00 mm
Cutting material: HP826
Number of cutting edges: 6
Helix angle: 36°
Special features: Cutting edge portion balanced on G2.5 according to DIN ISO 1940-G2.5

Application:

Design with chip breaker for optimum chip control. Ensures chips are shortened.

Preferred series in stock

Dimensions					z	Chip breaker	Shank form HB	
d ₁ f8	d ₂ h6	l ₁	l ₂	C x 45°			Specification	Order no.
8,00	8	81	40	0,16	6	3	SCM292-0800Z06R-F0016HB5-HP826	31348656
10,00	10	96	50	0,20	6	3	SCM292-1000Z06R-F0020HB5-HP826	31348657
12,00	12	112	60	0,24	6	3	SCM292-1200Z06R-F0024HB5-HP826	31348658
16,00	16	136	80	0,32	6	3	SCM292-1600Z06R-F0032HB5-HP826	31348660
20,00	20	160	100	0,40	6	3	SCM292-2000Z06R-F0040HB5-HP826	31348662

Available on request

14	14	122	70	0,28	6	3	SCM292-1400Z06R-F0028HB5-HP826	31348659
18	18	147	90	0,36	6	3	SCM292-1800Z06R-F0036HB5-HP826	31348661
25	25	195	125	0,5	6	3	SCM292-2500Z06R-F0050HB5-HP826	31348663

Configurable features



Shank form:
Shank form: HA



Specification:
SCM292-0800Z06R-F0008[shank form]5-HP826

Example:

SCM292-0800Z06R-F0008HA5-HP826



Dimensions in mm.

For cutting data recommendations, see end of the document.

Special designs and other coatings available upon request.

Cutting data recommendations for trochoidal milling cutters

Feed and cutting speed

OptiMill-Tro-Inox | SCM292

MMG*	Workpiece material		Strength/hardness [N/mm ²] [HRC]	Cooling		
				MQL/Air	Dry	KSS
M	M1	M1.1	Stainless steels, austenitic	< 700	✓	✓
		M1.2	Stainless steels, ferritic/austenitic (duplex)	< 1,000		✓
	M2	M2.1	Stainless cast steel, austenitic	< 700	✓	✓
		M3.1	Stainless cast steel, ferritic/austenitic (Duplex)	< 1,000		✓
S	S1	S1.1	Titanium, titanium alloys	< 400		✓
		S2.1	Titanium, titanium alloys	< 1,200		✓
	S2.2	Titanium, titanium alloys	> 1,200		✓	

Correction factors

Factor	v_c	a_e	h_m
	M		
2xD	1,05	1,05	1,05
3xD	1,00	1,00	1,00
4xD	0,92	0,90	0,94
5xD	0,80	0,80	0,87

Note

In the case of trochoidal milling, the specified cutting conditions change during the machining process. This also depends on the CAM software used and the machining position of the tool in the workpiece. The feed and cutting width or contact angle are constantly changing during machining in order to achieve, as far as is possible, the most constant average chip thickness depending on the contour.

* MAPAL machining groups

The specified machining values are guide values.

The optimum data for the respective machining task should be determined during the test or machining.



Discover tool and service solutions now that give you a lead:

BORE MACHINING

REAMING | FINE BORING

DRILLING FROM SOLID | BORING | COUNTERSINKING

MILLING

CLAMPING

TURNING

ACTUATING

SETTING | MEASURING | DISPENSING

SERVICES

FOLLOW US

